

GRUPA

October 2025

Every product we present is designed and manufactured by Grupa in Croatia. We are proud that each one is carefully assembled by hand, ensuring that our lamps not only emit light, but reflect the highest level of craftsmanship.

Onda	3
Okolo	21
Igram	41
Arigato	65
Ili Ili	109
Baluna	129
Model	161

Onda

Inspired by the classic lightbulb, the Onda pendant lamp blends elegance with simplicity. Crafted entirely from hand-blown glass, its gradient-coloured, carefully hand-coated surface transitions from deep hues on top to a soft white base.

When off, Onda reflects its surroundings and blends seamlessly into any environment; when turned on, Onda radiates a rich, focused glow. Available in a range of colours, each lamp offers a unique ambiance, making it ideal as either a stand-alone fixture or as part of creative clusters.







Onda

Pendant Gray



Pendant Blue



Onda



Pendant Green





Onda

Pendant Peach



Pendant Peach Pendant Brown



Onda

Pendant Ochre

Characteristics:

Powder coated aluminum top.
Hand-blown and hand-painted opal
glass diffuser. Steel ceiling rose
included. 2500 mm cord.

Light Source:
Dimmable GU10 LED PAR16
120°, 7W, 650 lm, 2700 K,
90CRI



Onda Pendant Lamp
ON-P

Ceiling rose diameter 86 mm
Glass diffuser diameter 175 mm
Glass diffuser height 245 mm
Cable 2500 mm (custom cable
length available on request).

Installation ceiling hardwiring

Shade Colour:



Gray

Brown

Peach

Ochre

Green

Blue

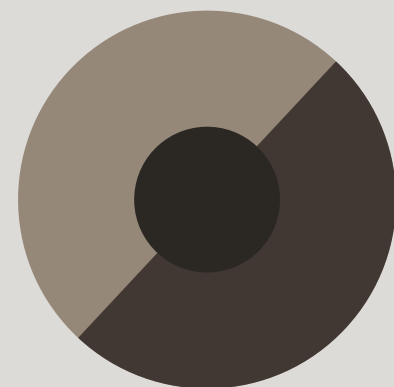
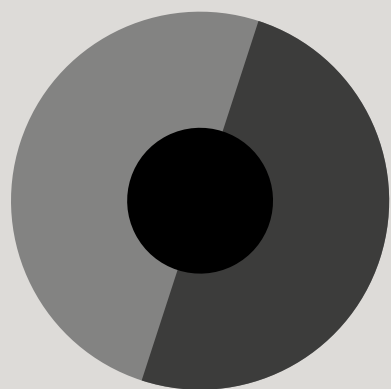
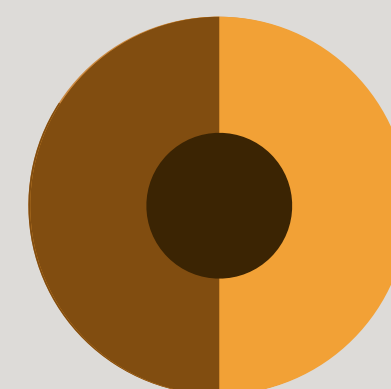
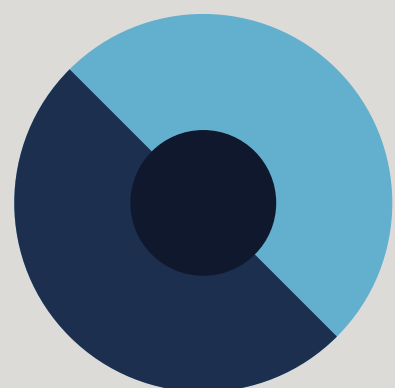
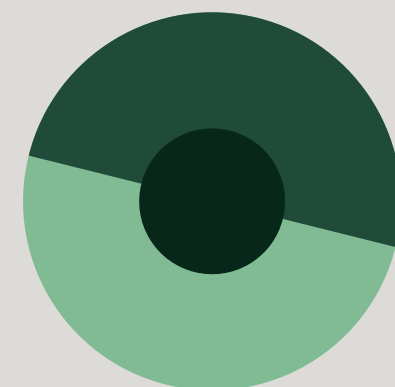
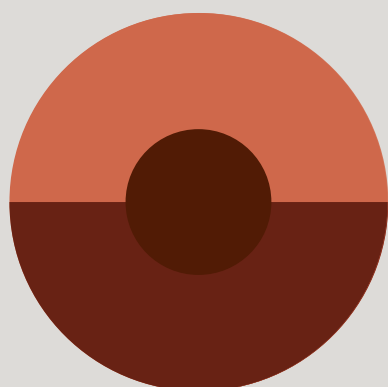
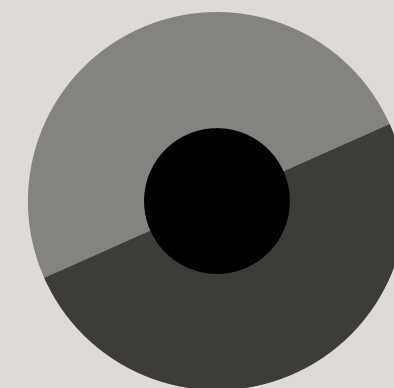
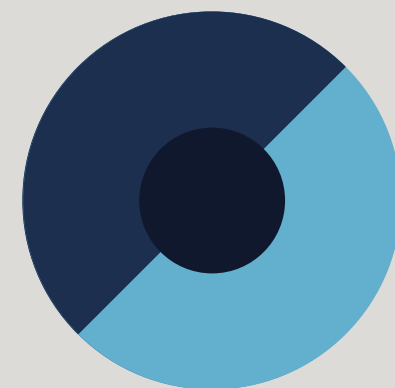
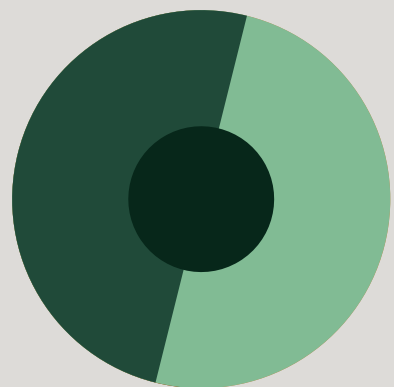

Okolo

The Okolo collection combines airy elegance and minimalist design. Featuring a floor lamp, table lamp, two wall-mounted options, and pendant lamps in two sizes, this cohesive series plays with lightness and structure.

In each version, a translucent textile shade encases a glass diffuser, supported by sleek aluminium strips. Inspired by movement and form, Okolo's seamless design creates a floating effect, blending pure functionality with weightless beauty and refinement.







Okolo

Pendant Lamp 35



Pendant Lamp 47



Okolo



Wall Lamp Small







Okolo

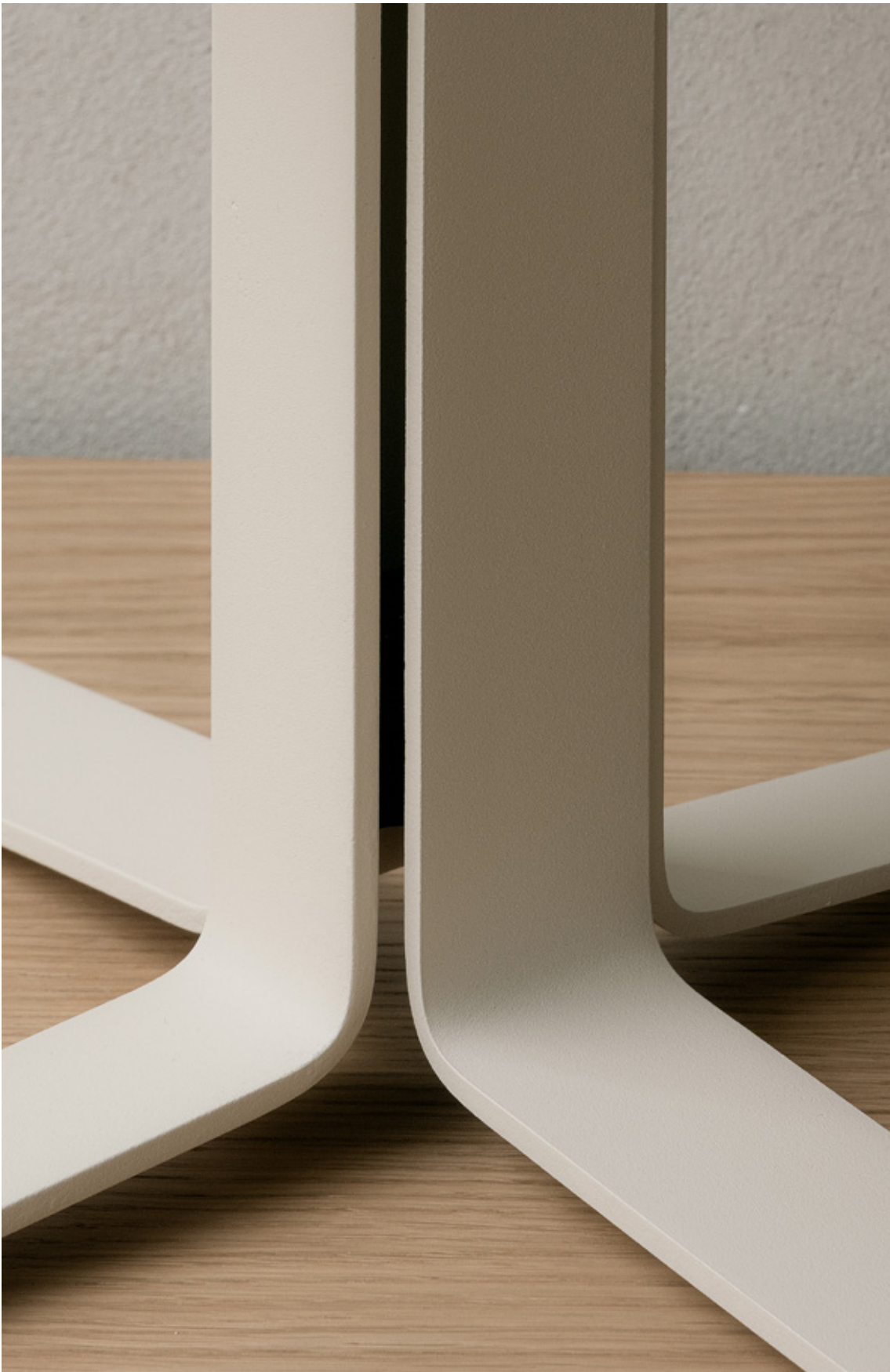
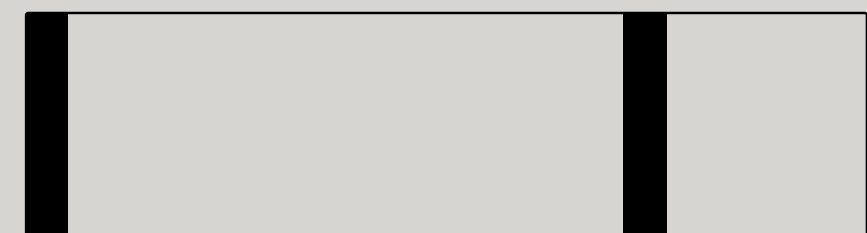
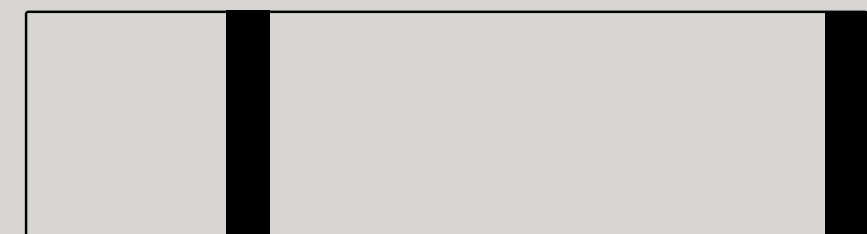
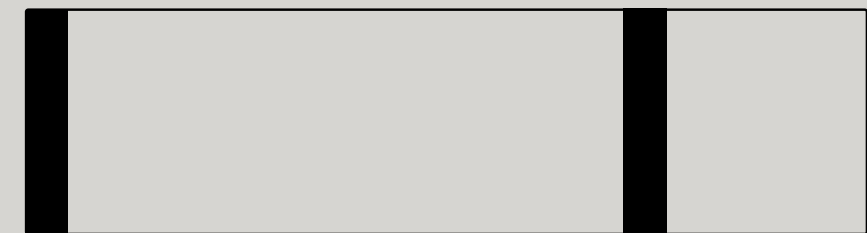
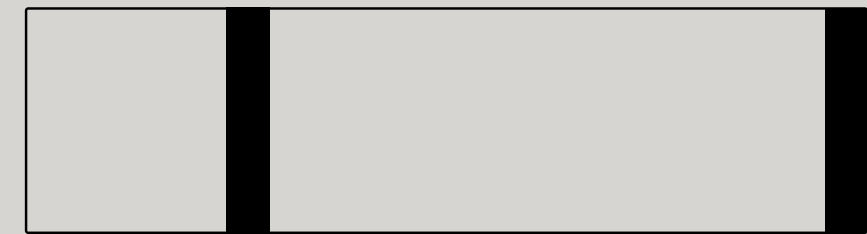
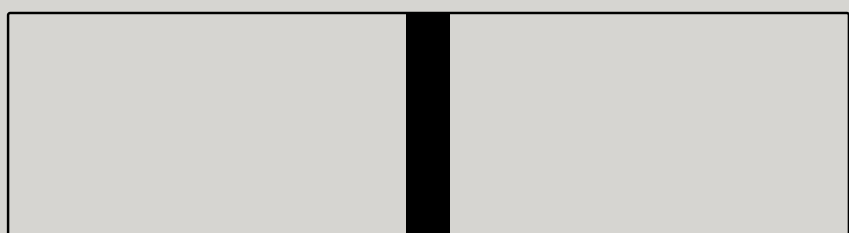
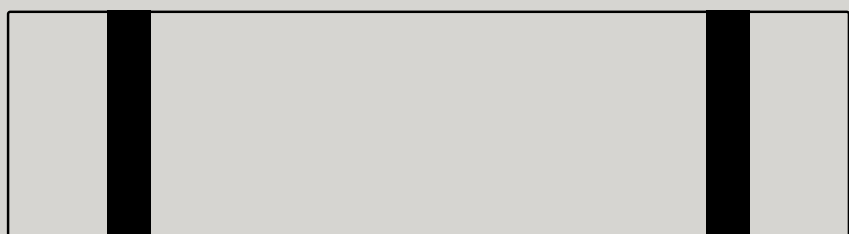
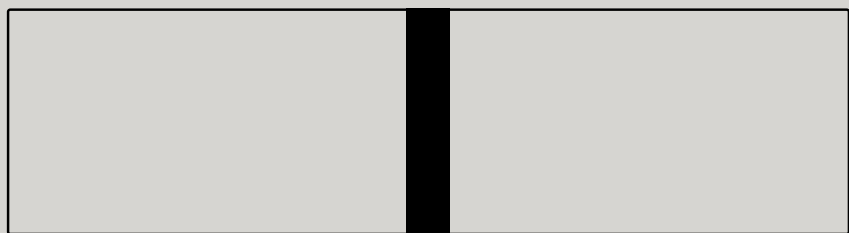
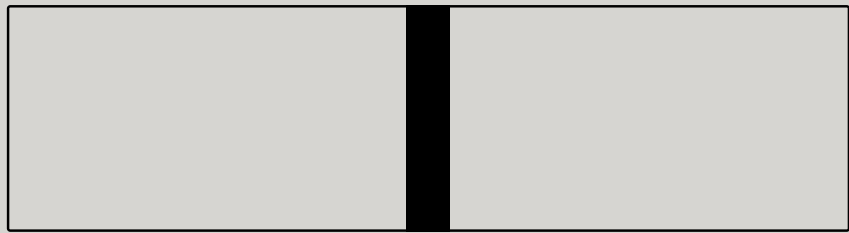

Table Lamp



Characteristics:

Powder coated aluminum body shaped and assembled by hand. White canvas textile shade. Steel ceiling rose included for pendant lamps. Installation for wall lamps hardwiring or plug-in, for ceiling and pendant lamps hardwiring only.

Colour:
Black, Off-White

Light Source:
Dimmable LED bulb, E27

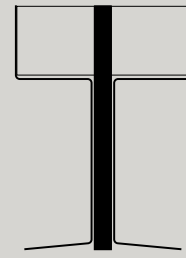
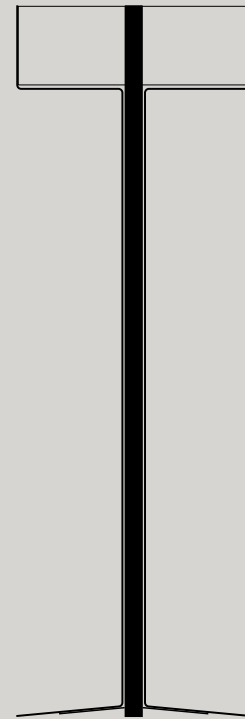

Table Lamp
OK-T

358 x 358 x 500 mm
Shade diameter 350 mm



Floor Lamp
OK-F

478 x 478 x 1450 mm
Shade diameter 470 mm

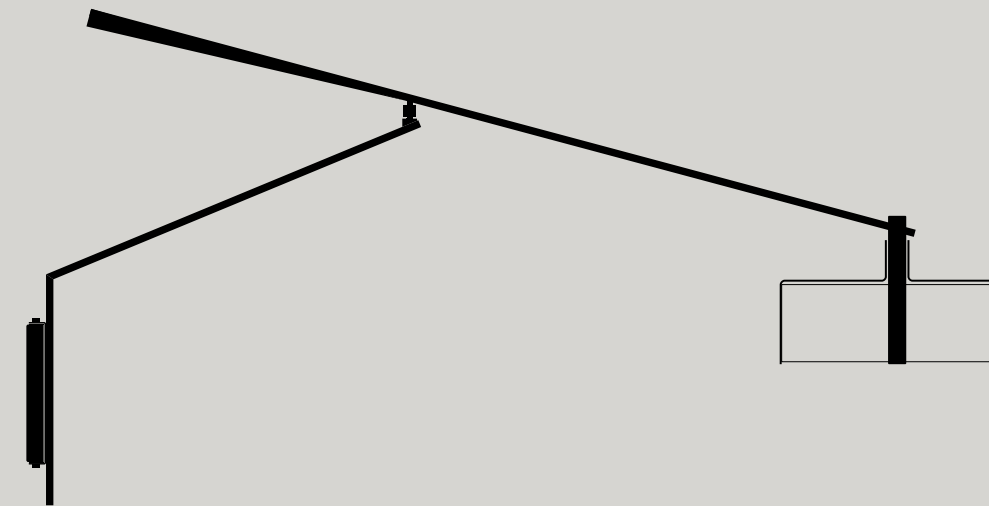

Wall Lamp Long
OK-W-L

2000 x 478 x 832 mm min
Shade diameter 470 mm
Removable cord length
2500 mm (included)

Installation wall hardwiring or
plug-in

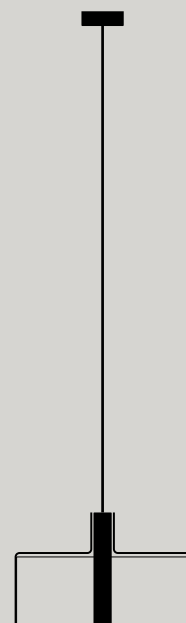

Pendant Lamp
OK-P-35

358 x 358 x 230 mm
Shade diameter 350 mm
Cord length 2500 mm
(included)

Installation ceiling hardwiring



Pendant Lamp
OK-P-47

478 x 478 x 250 mm
Shade diameter 470 mm
Cord length 2500 mm
(included)

Installation ceiling hardwiring

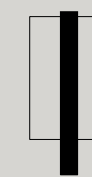

Wall Lamp Small
OK-W-S

160 x 182 x 334 mm
Shade diameter 160 mm
Removable cord length
2500 mm (included)

Installation wall hardwiring or
plug-in

Colour:



Black



Off-White

lgram

Igram, meaning “playing” in Croatian, is the word that best describes the process of creating this unique collection. Silent by stature and nature, Igram is an interplay of ambiance and function.

The most emblematic piece for the entire collection is the Igram Wall Lamp, a versatile lighting fixture with a strong yet unobtrusive graphic presence. The collection further plays with a unique multipurpose product Igram Lamp + Table, a floor lamp combined with a metal construction and various handcrafted tabletops.

Inspired by the minimalism of Igram collection, the Portable Table Lamp was expressly designed to provide unparalleled lighting performance and visual elegance for tables seating up to four diners, indoors and outdoors. The design comes in two slightly different variants, shape I and J, meant to provide subtle visual variety and a sense of rhythm.





Igram



Portable Table Lamp





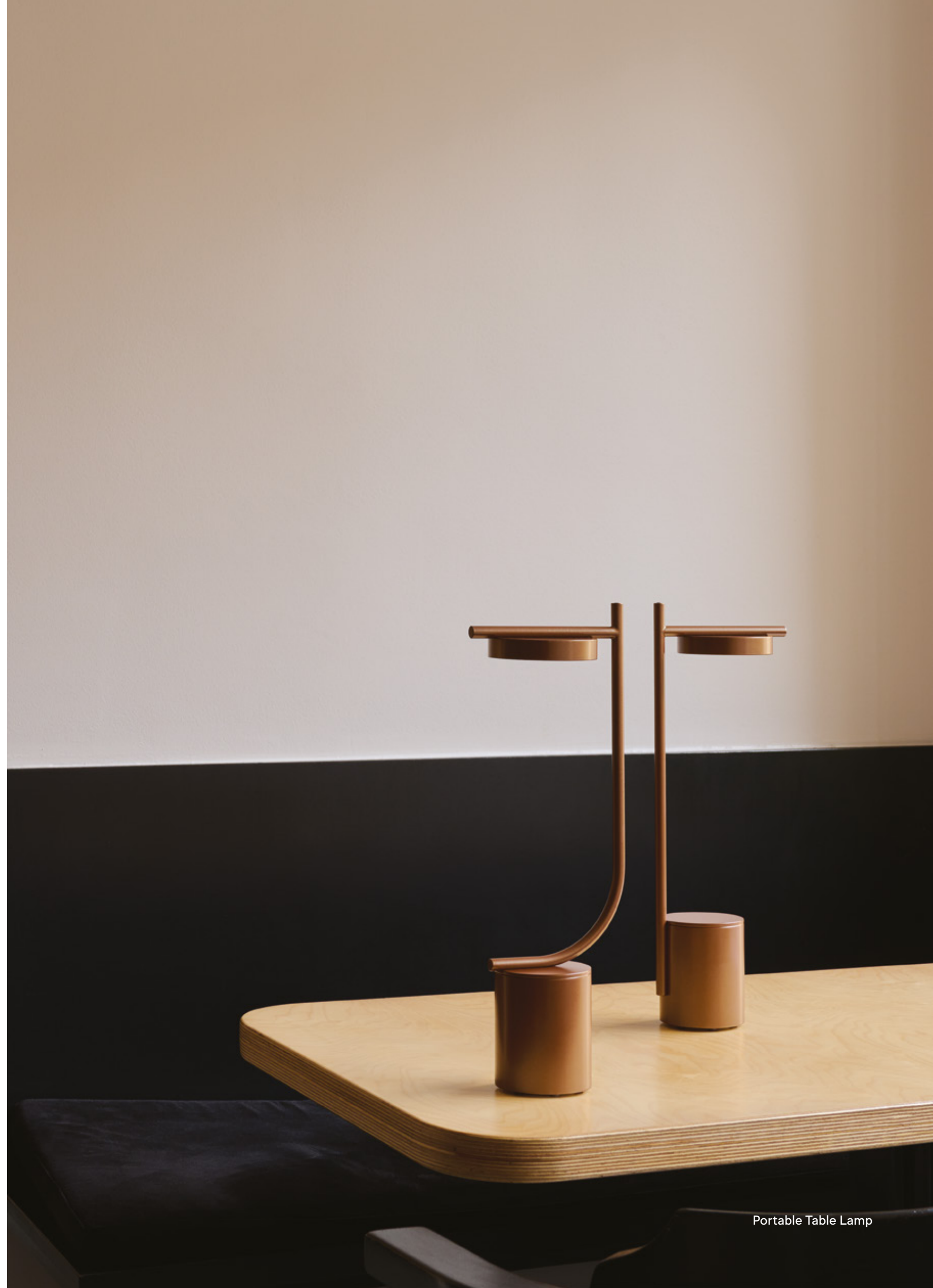



Igram



Portable Table Lamp



Igram



Wall Lamp





Igram



Lamp + Table

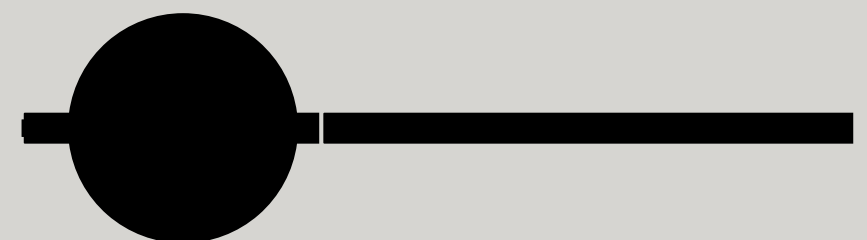
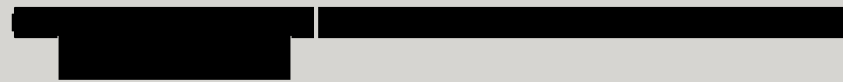

Characteristics:
 Steel body shaped, welded and powder coated in deep matte finish. Assembled by hand. Lampshades and arm rotation 180 degrees. Touch dimmer integrated on the horizontal arm. Opal PMMA light diffuser.

Colour:
 Black

Characteristics:
 Aluminium and steel body powder coated in deep matte finish. Opal PMMA light diffuser. Charging with USB-C cable. 3 levels of dimmability 100% | 45% | 15%, with autonomy 8 h | 17 h | 63 h. Low battery indicator. Indoor and outdoor use.

Colour:
 Black, White, Gray, Blue, Green, Red, Bronze, Brass

**Lamp + Table
 IG-LT**

Tabletop diameter 405 mm
 Tabletop height 400 mm
 Lamp height 1270 mm
 Lamp width 435 mm
 Arm length 385 mm
 Shade diameter 104 mm
 Cord length 2500 mm

Light Source:
 Dimmable LED; 5,4 W;
 580 lm; 2700 K

LED driver with interchangeable plugs

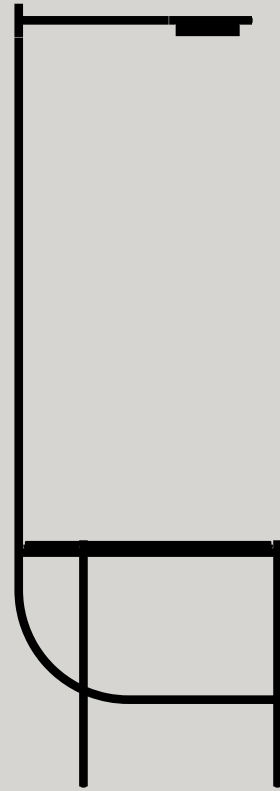

**Wall Lamp
 IG-W**

Base diameter 104 mm
 Lamp height 940 mm
 Arm length 385 mm
 Shade diameter 104 mm
 Removable cord length 2500 mm (included)

Installation wall hardwiring or plug-in

Light Source:
 Dimmable LED; 2 x 5,4 W;
 2 x 580 lm; 2700 K

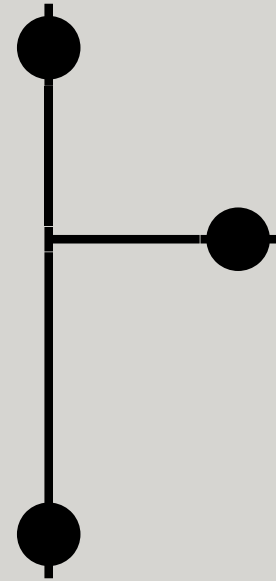

**Portable Table Lamp
 IG-PT-I**

Base diameter 80 mm
 Base height 100 mm
 Lamp height 400 mm
 Shade diameter 90 mm
 Charging cable included

Light Source:
 Dimmable LED; 4.2 W;
 358 lm; 2700 K; CRI ≥ 90



**Portable Table Lamp
 IG-PT-J**

Base diameter 80 mm
 Base height 100 mm
 Lamp height 400 mm
 Shade diameter 90 mm
 Charging cable included

Light Source:
 Dimmable LED; 4.2 W;
 358 lm; 2700 K; CRI ≥ 90



Tabletop Materials:
 Tempered Glass RAL

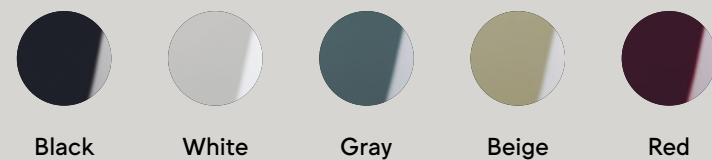

Oak Veneer

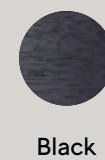

Glazed Ceramic

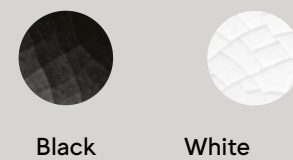

Colour:

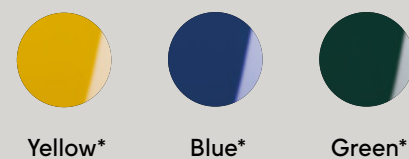
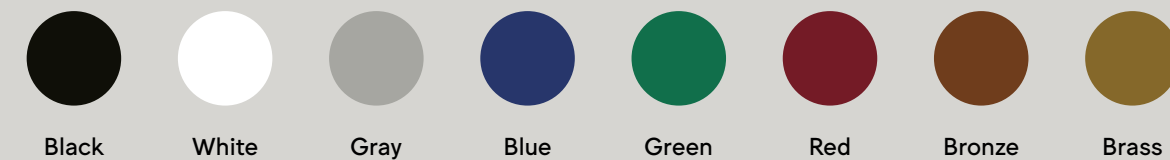

* On Request (MOQ)

Arigato

The idea behind our Arigato lamp collection was to present a stylized everyday object inspired by the shape of a person bowing, a universally recognized gesture used to express gratitude and greetings. Its adjustability and applicability ensure a beautiful performance in various spaces and contexts. The mobility of the shade and the arms of the lamp enables the projection of the light in every direction.

The collection is composed of table, floor, wall, pendant and ceiling models that come with a handmade steel body and aluminium shade. Red, blue and green matte colours have been added to the existing colour range of black, white and raw.

Along with a 22 cm diameter lampshade throughout the collection, ceiling, wall and pendant versions are also available with 45 cm lampshades.







Arigato



Pendant Lamp 45 Pendant Lamp





Arigato

Wall Lamp Long



Wall Lamp Short



Arigato



Wall Lamp Short

Wall Lamp



Arigato

Wall Lamp Extra Short Wall Lamp Short Wall Lamp Wall Lamp Long



Wall Lamp Long



Arigato

Wall Lamp P2



Wall Lamp Double





Arigato

Wall Lamp 45



Ceiling Lamp 45

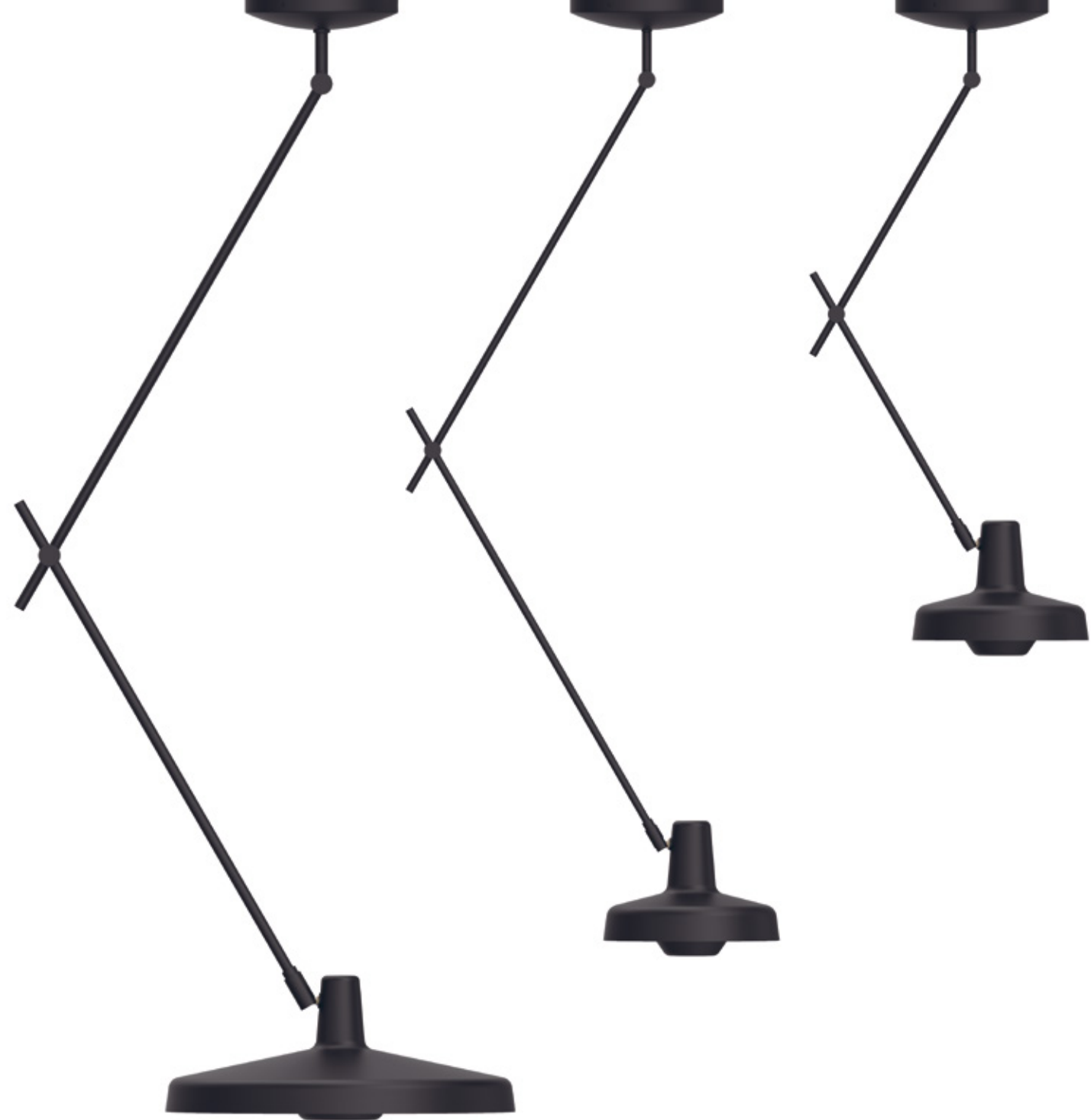

Arigato

Ceiling Lamp 45 Ceiling Lamp Long Ceiling Lamp



Ceiling Lamp Long





Arigato

Ceiling Lamp Double



Ceiling Lamp P3

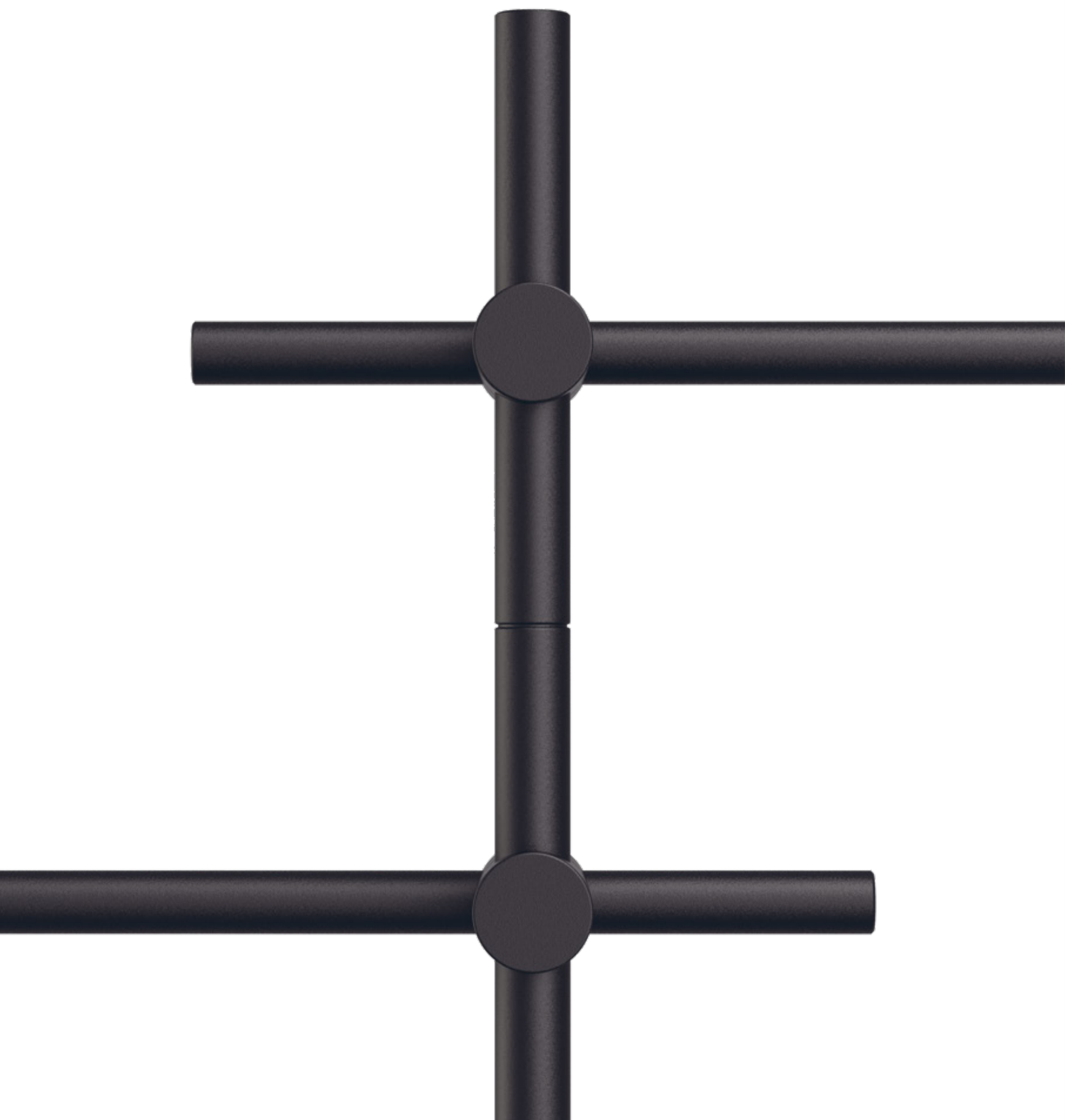



Arigato

Floor Lamp



Floor Lamp Palace



Arigato



Floor Lamp Double



Arigato



Table Lamp

Table Lamp Palace

Arigato's joint system is custom made to hide the cable. It allows you to effortlessly move the lamp with a single gesture, without turning any knobs or levers. The shade joint is made from three different materials, which makes its adjustments completely silent.

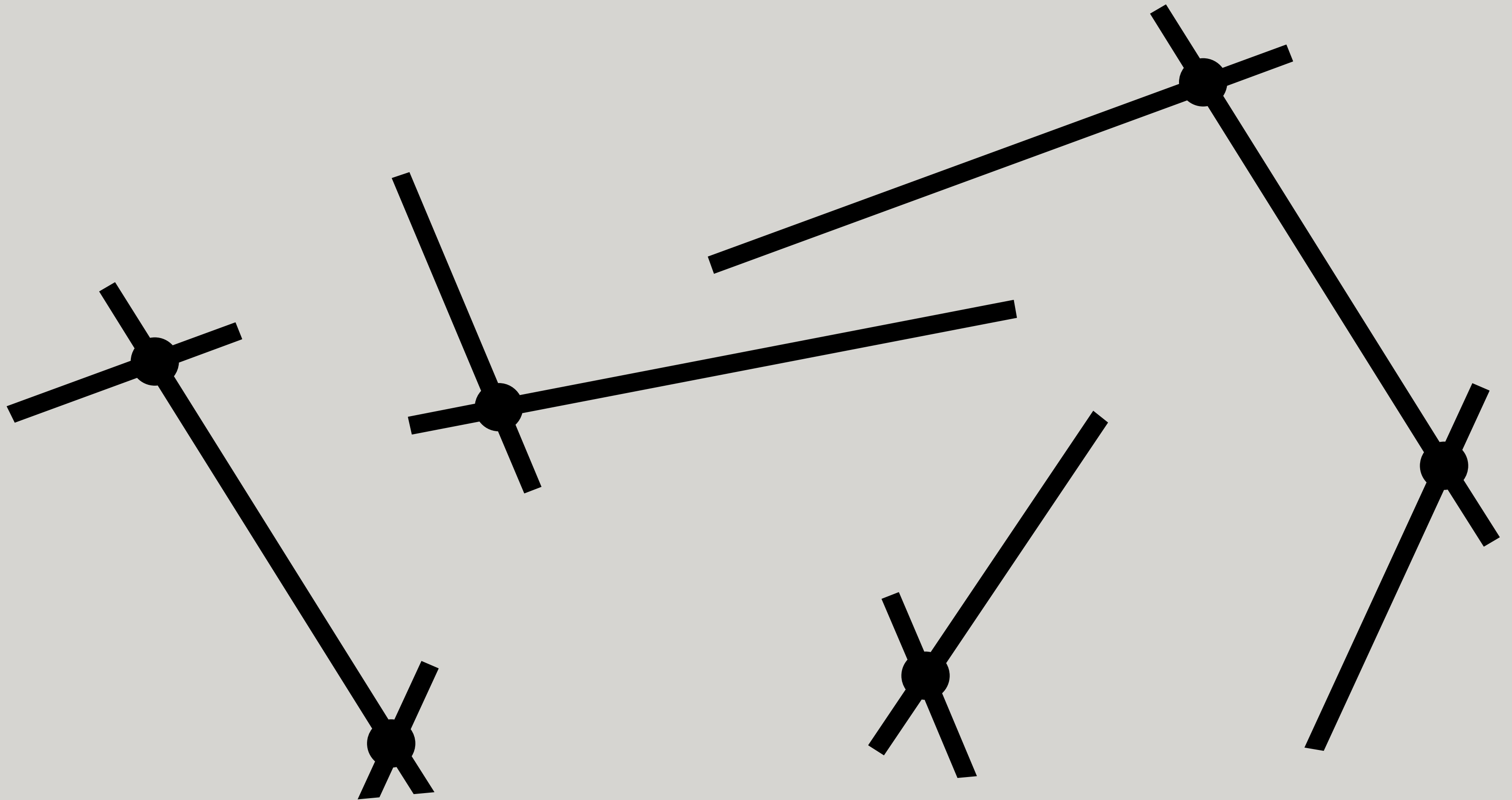

Characteristics:
 Press spun aluminium lampshade and steel body shaped, welded and assembled by hand. Powder coated. Lampshade rotation 360 degrees. Undershade included. Steel ceiling rose included for pendant lamps. Installation for wall lamps hardwiring or plug-in, for ceiling and pendant lamps hardwiring only.

Colour:
 White, Black

Raw (lacquered raw aluminum) available only on pendants

Red, Blue, Green available only on pendants and Wall Extra Short

Light Source:
 E27 max 70W (not included).

Wall Lamp Extra Short
 AR-W-XS

Base diameter 89 mm
 Arm length 120 mm
 Shade diameter 228 mm
 Arm rotation 135 degrees

Option 1
 With On/Off switch and removable cord, length 2500 mm

Option 2
 Without switch and cord



Wall Lamp Short
 AR-W-S

Base diameter 100 mm
 Base rod length 50 mm
 Arm length 320 mm
 Shade diameter 228 mm
 Arm rotation 180 degrees
 Removable cord length 2500 mm (included)
 On/Off switch on the lamp base



Wall Lamp P2
 AR-WP2

Base diameter 100 mm
 Base rod length 50 mm
 Arm length 2 x 550 mm
 Shade diameter 228 mm
 Arm rotation 180 degrees
 Removable cord length 2500 mm (included)
 On/Off switch on the lamp base

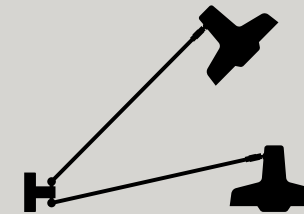

Wall Lamp Double
 AR-W2

Base diameter 100 mm
 Base rod length 50 mm
 Arm length 2 x 350+350 mm
 Shade diameter 228 mm
 Arm rotation 180 degrees
 Removable cord length 2500 mm (included)
 On/Off switch on the lamp base

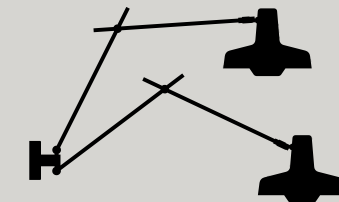

Wall Lamp
 AR-W

Base diameter 100 mm
 Base rod length 50 mm
 Arm length 350+350 mm
 Shade diameter 228 mm
 Arm rotation 180 degrees
 Removable cord length 2500 mm (included)
 On/Off switch on the lamp base

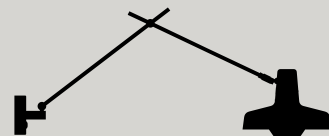

Wall Lamp Long
 AR-W-L

Base diameter 100 mm
 Base rod length 50 mm
 Arm length 550+550 mm
 Shade diameter 228 mm
 Arm rotation 180 degrees
 Removable cord length 2500 mm (included)
 On/Off switch on the lamp base

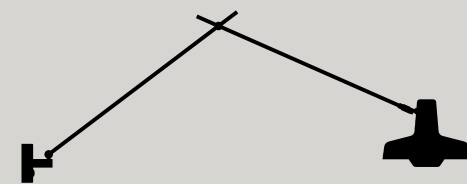

Wall Lamp 45
 AR-W-45

Base diameter 130 mm
 Base rod length 63 mm
 Arm length 700+670 mm
 Shade diameter 450 mm
 Arm rotation 180 degrees
 Removable cord length 2500 mm (included)
 On/Off switch on the lamp base

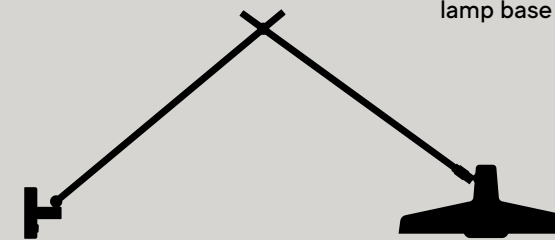

Wall Lamp Double Long Short
 AR-W2-LS

Base diameter 100 mm
 Base rod length 50 mm
 Long arm length 550+550 mm
 Short arm length 350+350 mm
 Shade diameter 228 mm
 Arm rotation 180 degrees
 Removable cord length 2500 mm (included)
 On/Off switch on the lamp base

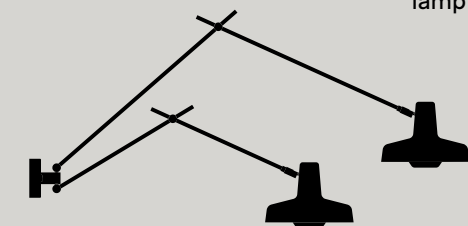



Ceiling Lamp
AR-C

Base diameter 200 mm
Base rod length 70 mm
Arm length 350+350 mm
Shade diameter 228 mm

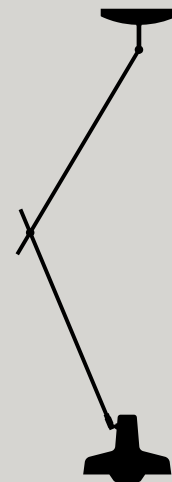

Ceiling Lamp Long
AR-C-L

Base diameter 200 mm
Base rod length 140 mm
Arm length 550+550 mm
Shade diameter 228 mm

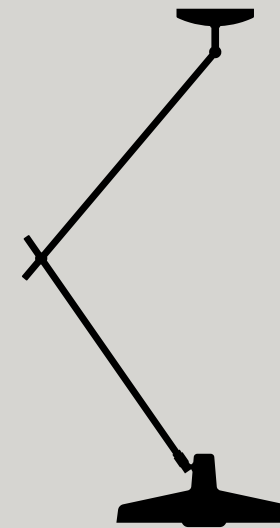

Ceiling Lamp 45
AR-C-45

Base diameter 200 mm
Base rod length 140 mm
Arm length 700+670 mm
Shade diameter 450 mm



Pendant Lamp
AR-P

Ceiling rose diameter 86 mm
Shade diameter 228 mm
Cable 2500 mm (custom cable
length available on request)

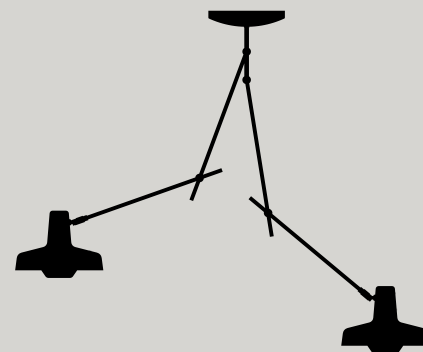

Ceiling Lamp Double
AR-C2

Base diameter 200 mm
Base rod length 140 mm
Arm length 2x 350+350 mm
Shade diameter 228 mm

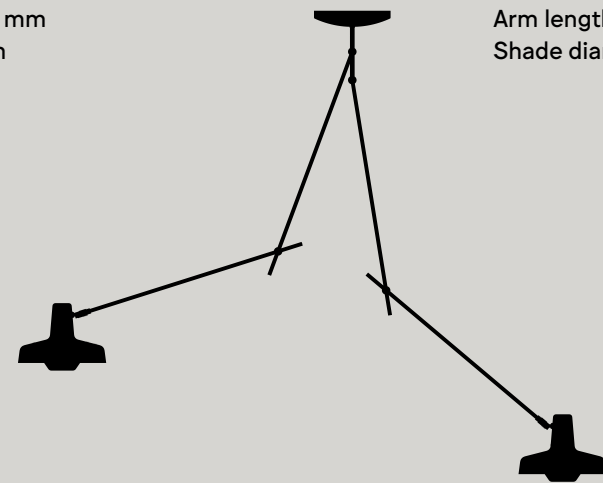

Ceiling Lamp Long Double
AR-C2-L

Base diameter 200 mm
Base rod length 140 mm
Arm length 2x 550+550 mm
Shade diameter 228 mm

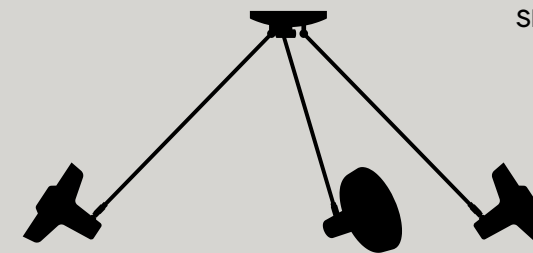

Ceiling Lamp P3
AR-CP3

Base diameter 200 mm
Arm length 3x 650 mm
Shade diameter 228 mm

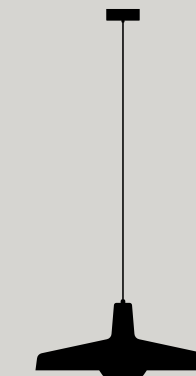

Pendant Lamp 45
AR-P-45

Ceiling rose diameter 86 mm
Shade diameter 450 mm
Cable 2500 mm (custom cable
length available on request)

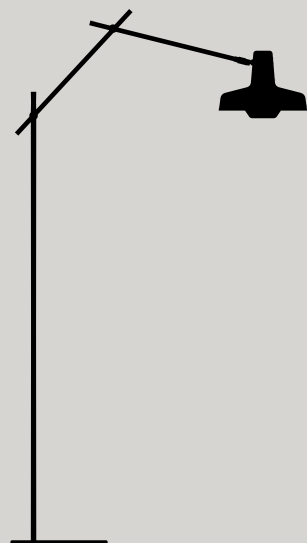

Floor Lamp
AR-F

Base diameter 250 mm
Base rod length 1100 mm
Arm length 300+360 mm
Shade diameter 228 mm
Cord length 1600 mm;
cord switch 500 mm from
the lamp base



Floor Lamp Palace
AR-FP

Base diameter 250 mm
Base rod length 1100 mm
Arm length 420 mm
Shade diameter 228 mm
Cord length 1600 mm;
cord switch 500 mm from
the lamp base

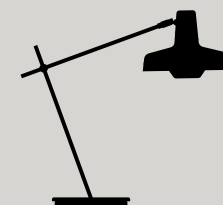

Table Lamp Palace
AR-TP

Base diameter 200 mm
Base rod length 350 mm
Arm length 350 mm
Shade diameter 228 mm
Cord length 1300 mm;
cord switch 100 mm from
the rotating lamp base

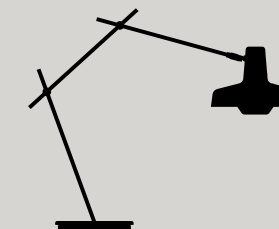
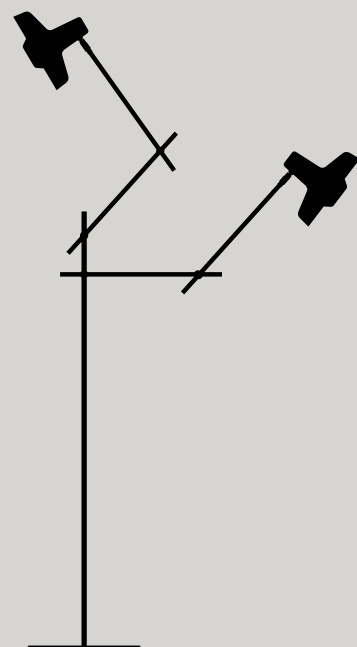

Table Lamp
AR-T

Base diameter 200 mm
Base rod length 350 mm
Arm length 250+320 mm
Shade diameter 228 mm
Cord length 1300 mm;
cord switch 100 mm from
the rotating lamp base



Floor Lamp Double
AR-F2

Base diameter 300 mm
Base rod length 1100 mm
Arm length 2x 300+360 mm
Shade diameter 228 mm
Cord length 1600 mm;
cord switch 500 mm from
the lamp base

Colour:



Black



White



Red*



Blue*



Green*



Raw**

* Available for pendants and Wall Extra Short only

** Available for pendants only

||i ||i

Ili Ili is something of a toy for grown-ups that invites you to combine various forms and colours into your own personalised lamp. It is lightweight, simple, and extremely versatile, a collection of modular pendant lamps composed of six different handcrafted aluminium elements.

Coming in various shades of matte colours and different cable colours, the final combination of elements is determined by the user. By playing with the design through the online configurator, the customer builds their own lamp and creates a relationship with it even before it arrives at their home.









Gone Fishing



Cat's Hat







Do you want to go a colourful or monochromatic way? You'd prefer a big, four-piece combination or a simple lamp with just one piece? Do you want that element upside down? The combinations and possibilities are almost limitless. And they all look amazing. So, let's play.

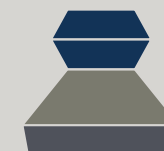
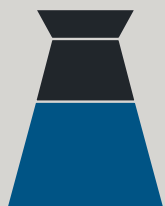
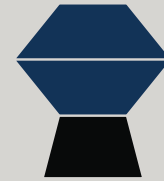
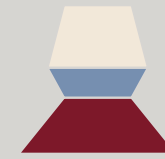



Characteristics:





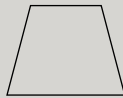

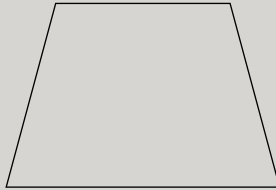
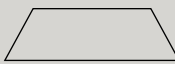
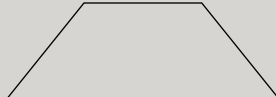
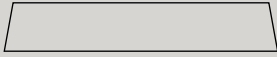











Aluminium lampshade is press spun by hand. Powder coated in different matte shades. Plastic ceiling cup is included for pendant lamps. Wall lamps include rotating arm, removable cord and On/Off switch on the lamp base. Installation ceiling hardwiring, for wall lamps hardwiring or plug-in.

Light Source:







E27 max 75W (not included).

	A ø 76 mm ø 125 mm H 95 mm		B ø 125 mm ø 185 mm H 115 mm
	C ø 185 mm ø 290 mm H 196 mm		D ø 125 mm ø 185 mm H 54 mm
	E ø 125 mm ø 317 mm H 115 mm		F ø 290 mm ø 317 mm H 54 mm







Element Colour RAL:

								
9005	9016	1013	7024	7005	7030	7032	3005	3000
								
5003	5010	5014	6011	6021	6019	1032	1023	1018

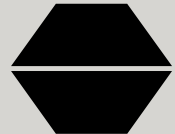
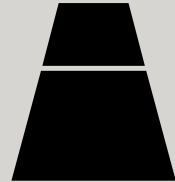
Cord Colour:

						
Black	White	Gray	Red	Blue	Green	Yellow

* Cord and switch for wall lamps available only in black and white colour

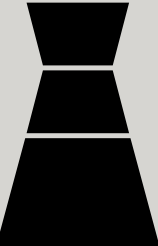
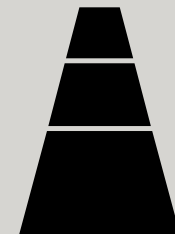
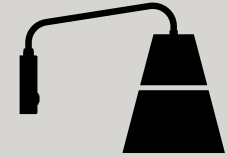
	Madame Bovary BB W 185 mm H 230 mm		Kiss Me EE W 317 mm H 230 mm		Morning After BC W 290 mm H 311 mm
	La Lava ABD W 185 mm H 264 mm		Cocktail Please ADB W 185 mm H 264 mm		Gone Fishing AAB W 185 mm H 305 mm
	Nighty Night ABB W 185 mm H 325 mm		Cat's Hat AEF W 317 mm H 264 mm		Prom Queen BDE W 317 mm H 284 mm
	Dance All Night BBC W 290 mm H 426 mm		Coney Cone ABC W 290 mm H 406 mm		Wall Lamp AB-W W 350 mm H 260 mm

Baluna

Designing Baluna, we aimed to design light itself; the way it occupies space and affects mood. Every segment of Baluna has passed through the hands of master craftsmen who have shaped and painted the tubing and the shades, and handblown the glass. Their skilful eyes and expert touch guarantee the quality of each and every lamp. The collection is available with optional dimmer that enables maximum control over the light intensity. Finally, the triple coated satin glass opal diffuser, which can rotate around its axis infinitely, provides fine control over the ambient light.

All the functional parts, including the power switch, dimmer, power cord and powder coated tightening rings, have been custom designed to fit seamlessly into the form of the lamp. Apart from floor, table, wall, ceiling and pendant models, the Baluna collection is completed with two versions of chandeliers, the only products of this type and size offered by Grupa.





Baluna



Pendant









Baluna



Ceiling Lamp



Baluna

Table / Wall Lamp

Ceiling Lamp







Baluna

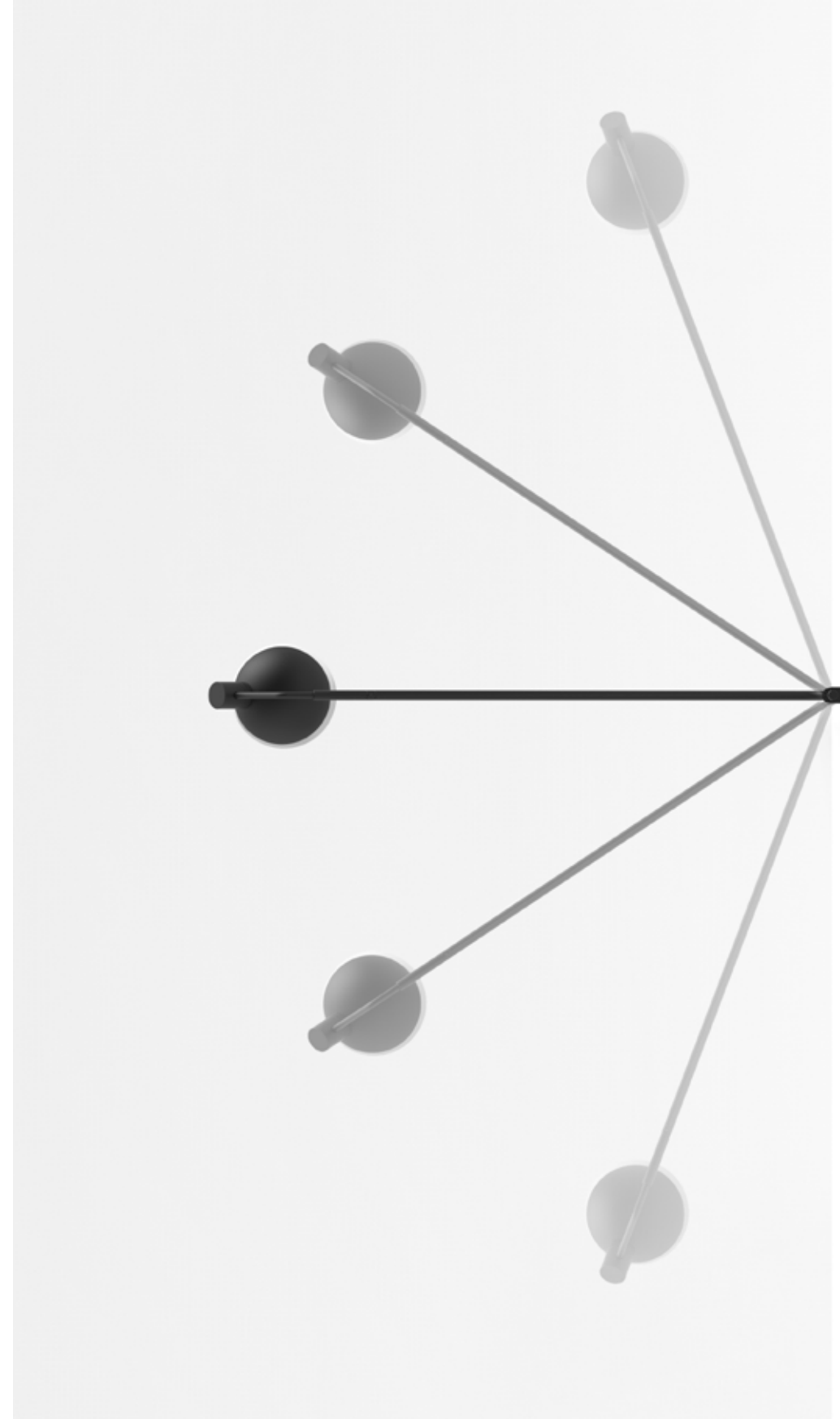

Wall Lamp Long





Baluna



Floor Lamp

Table Lamp

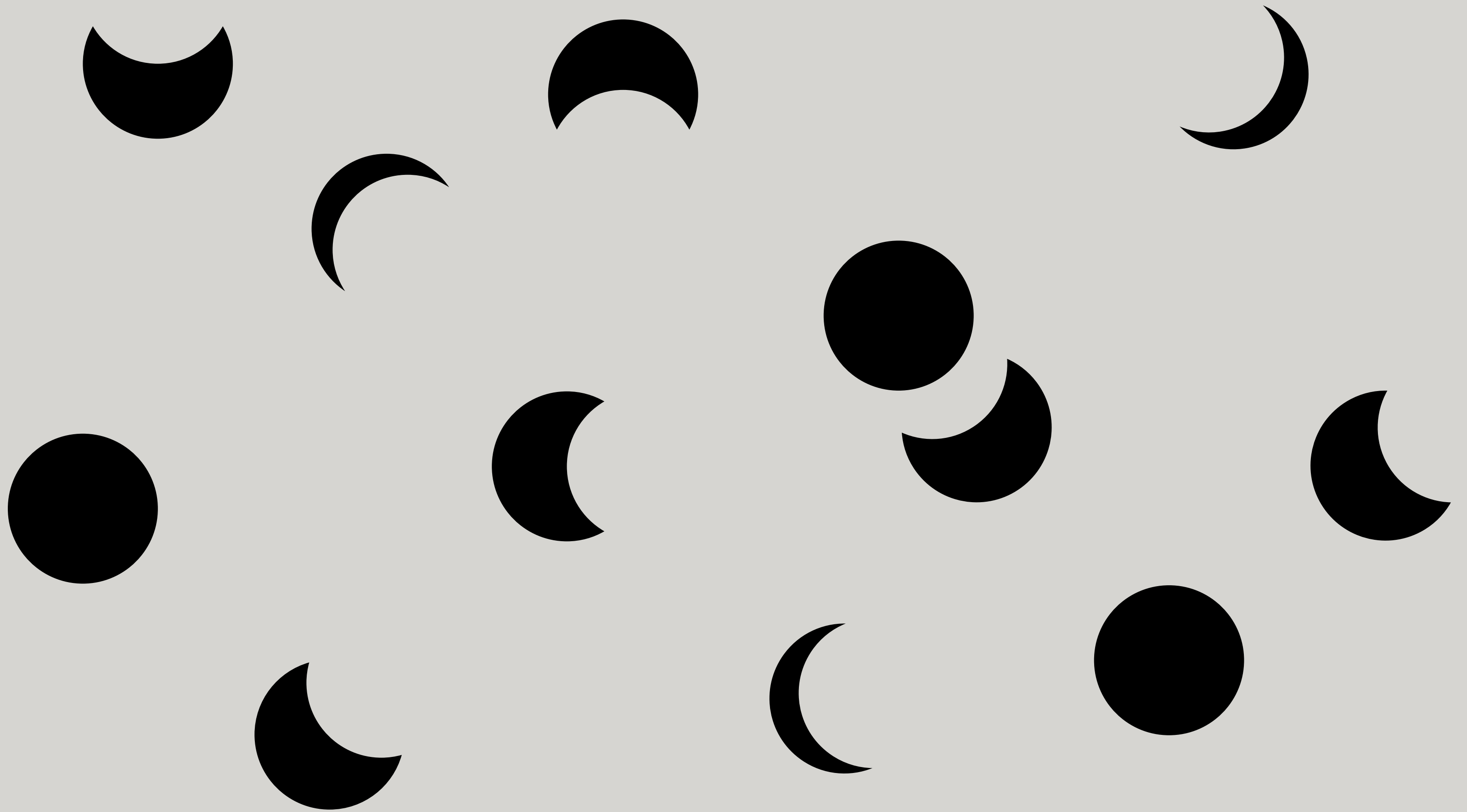

Characteristics:

Steel body shaped, welded and powder coated in deep matte finish. Assembled by hand. Triple coated opal glass diffuser can rotate around its axis indefinitely. Optional dimmer. Steel ceiling rose included for pendant lamp.

Colour:
Black

Light Source:
E14 max 8W, max Ø36 mm.
Non-dimmable or dimmable LED bulb.

Wall Lamp Long
BA-W-L

1160 x 200 x 320 mm min
1900 x 200 x 570 mm max
Sphere shade diameter 200 mm
Non-removable cord length
2500 mm (included)
Adjustable length 1160 – 1900 mm
Arm rotation 180 degrees

Installation plug-in

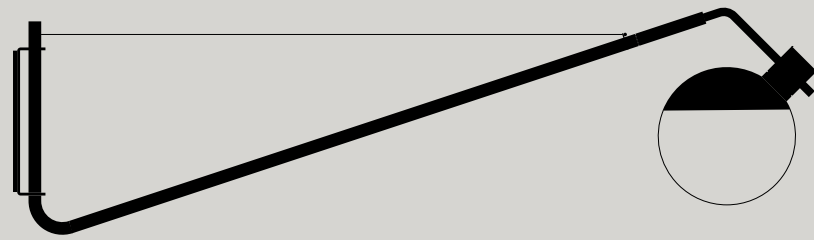

Ceiling / Wall Lamp
BA-CW

200 x 200 x 270 mm
Sphere shade diameter 200 mm
Cord not available

Installation wall or ceiling
hardwiring

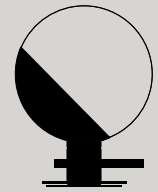
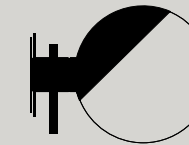
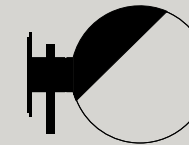
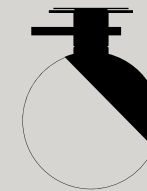

Table / Wall Lamp
BA-TW

200 x 200 x 270 mm
Sphere shade diameter 200 mm
Non-removable cord length
2500 mm (included)

Installation plug-in

Floor Lamp
BA-F

380 x 380 x 1355 mm
Sphere shade diameter 200 mm
Non-removable cord length
2500 mm (included)

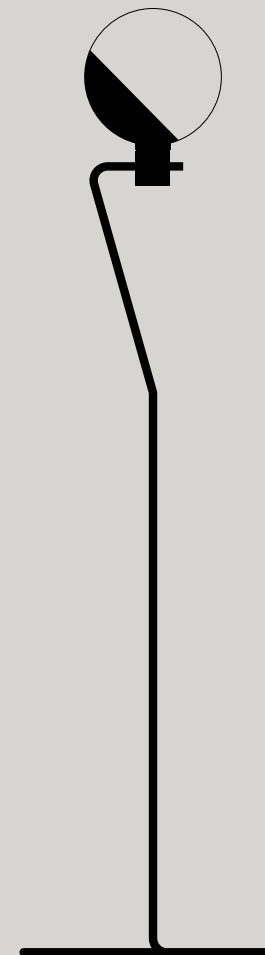

Table Lamp
BA-T

250 x 250 x 465 mm
Sphere shade diameter 200 mm
Non-removable cord length
2000 mm (included)



Wall Lamp Medium
BA-W-M

525 x 200 x 390 mm
Sphere shade diameter 200 mm
Removable cord length
2500 mm (included)
Arm rotation 135 degrees

Installation wall hardwiring or
plug-in

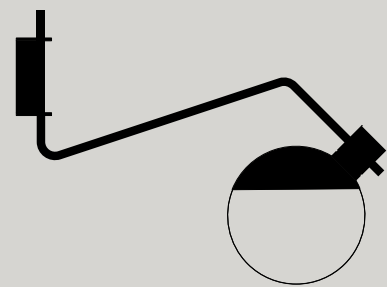

Chandelier 3
BA-CH3

Base diameter 240 mm
Height 700 mm
Arm length 1185, 595 mm
Sphere shade diameter 200 mm
Rotating arms

Installation ceiling hardwiring

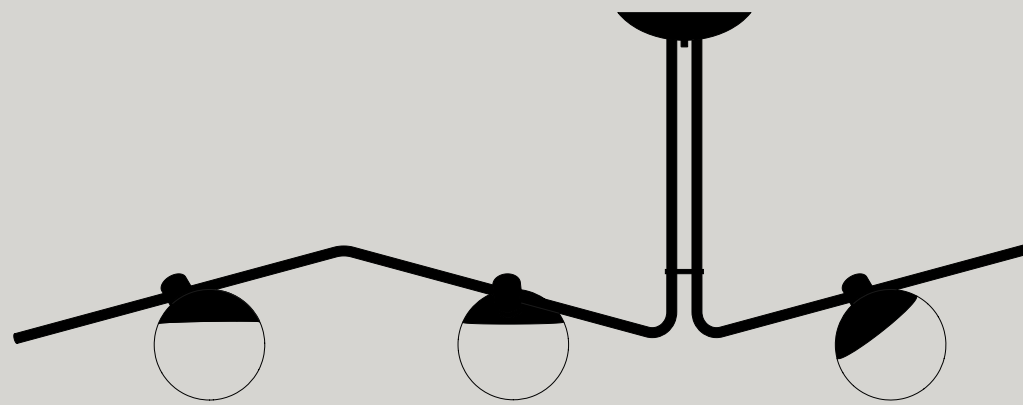

Pendant Lamp
BA-P

Ceiling rose diameter 86 mm
Sphere shade diameter 200 mm
Cable 2500 mm (custom cable length available on request).

Installation ceiling hardwiring

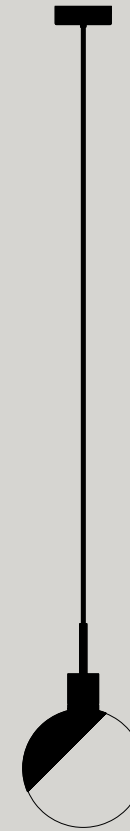

Ceiling Lamp
BA-C

200 x 200 x 1360 mm min
200 x 200 x 2030 mm max
Sphere shade diameter 200 mm
Adjustable height
1360 – 2030 mm
Removable cord length
5000 mm (included)

Installation ceiling hardwiring
or plug-in

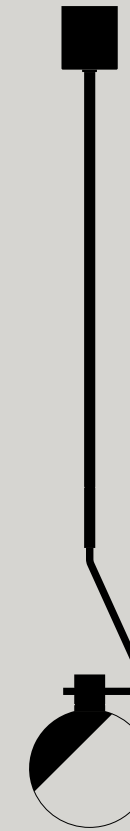

Chandelier 6
BA-CH6

Base diameter 240 mm
Height 905 mm
Arm length 3 x 1275 mm
Sphere shade diameter 200 mm
Rotating arms

Installation ceiling hardwiring

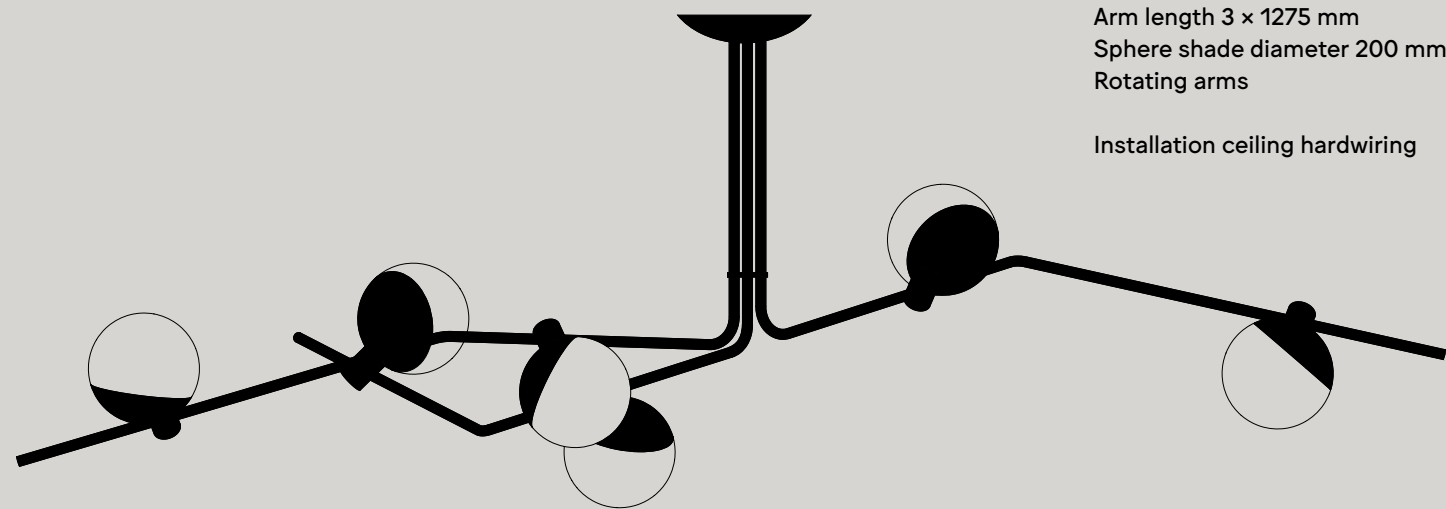

Model

Model is essentially a replication of a playful sketch in space, yet, in a way it was born out of consideration of the very material and an extreme reduction of elements from which a given object is made. Free from complications and with a “not yet finished” look, Model is a unique floor lamp.

The final design is left to the customer and it depends on the choices provided by Grupa. To finish a Model, one has to choose from three different sets of steel frames in a black or white finish and various possibilities in the colour of the textile cord. Model comes with a lightbulb selected by Grupa, however, everyone is free to experiment.





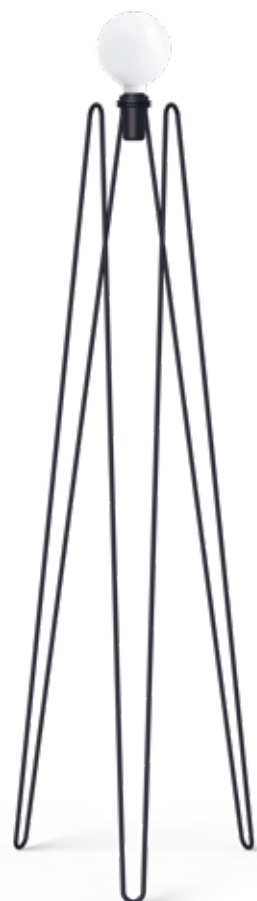

Model

Model 1 Model 2 Model 3



Model 2



Model

Model 3 Model 2



Dark Green Cord



Model

Model 1

Characteristics:
Powder coated steel frames shaped,
welded and assembled by hand.
3000 mm textile cord.

Light Source:
E27 max 42W (Ø125 mm glass
LED bulb included).

Colour:
Black, White.



Model 1
M1

L 270 mm
W 270 mm
H 1470 mm

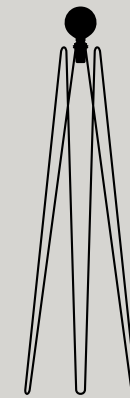

Model 2
M2

L 350 mm
W 350 mm
H 1470 mm



Model 3
M3

L 270 mm
W 310 mm
H 1470 mm

Frame Colour:



Cord Colour:

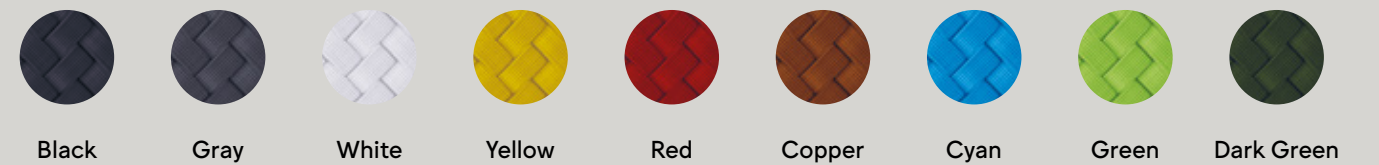

Index

Okolo

Wall Lamp Small

OK-W-S



Table Lamp

OK-T



Floor Lamp

OK-F



Pendant Lamp 47

OK-P-47



Pendant Lamp 35

OK-P-35



Wall Lamp Long

OK-W-L

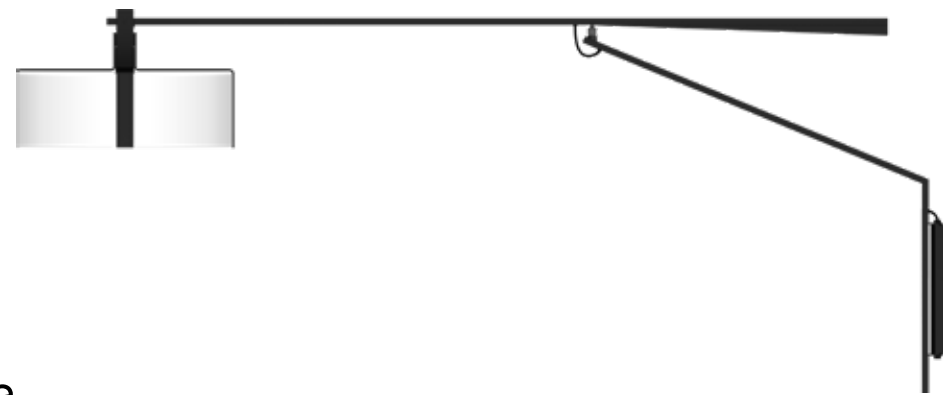

Onda

Pendant

ON-P



Igram

Lamp + Table

IG-LT



Wall Lamp

IG-W



Portable Table Lamp

IG-PT-I



Portable Table Lamp

IG-PT-J



Model

Model 1

M1

Model 2

M2

Model 3

M3



Arigato

Wall Lamp Extra Short

AR-W-XS



Wall Lamp Short

AR-W-S



Wall Lamp

AR-W

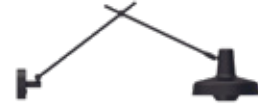

Wall Lamp Long

AR-W-L

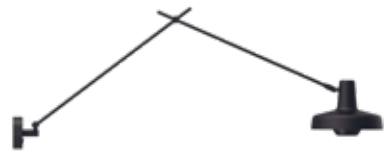

Wall Lamp 45

AR-W-45

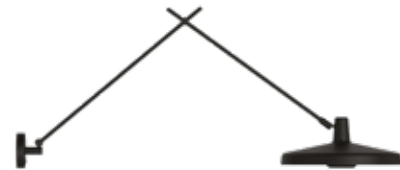

Wall Lamp P2

AR-WP2



Wall Lamp Double

AR-W2



Wall Lamp Double Long Short

AR-W2-LS

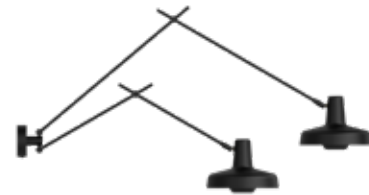

Pendant Lamp

AR-P



Table Lamp Palace

AR-TP



Table Lamp

AR-T



Pendant Lamp 45

AR-P-45



Ceiling Lamp

AR-C



Ceiling Lamp Long

AR-C-L



Ceiling Lamp 45

AR-C-45



Ceiling Lamp Double

AR-C2



Ceiling Lamp Long Double

AR-C2-L



Ceiling Lamp P3

AR-CP3



Floor Lamp Palace

AR-FP



Floor Lamp

AR-F



Floor Lamp Double

AR-F2



Baluna

Pendant Lamp

BA-P

Ceiling Lamp

BA-C

Floor Lamp

BA-F



Wall Lamp Long

BA-W-L

Wall Lamp Medium

BA-W-M



Table / Wall Lamp

BA-TW

Table Lamp

BA-T



Ceiling / Wall Lamp

BA-CW



Chandelier Lamp 6

BA-CH6

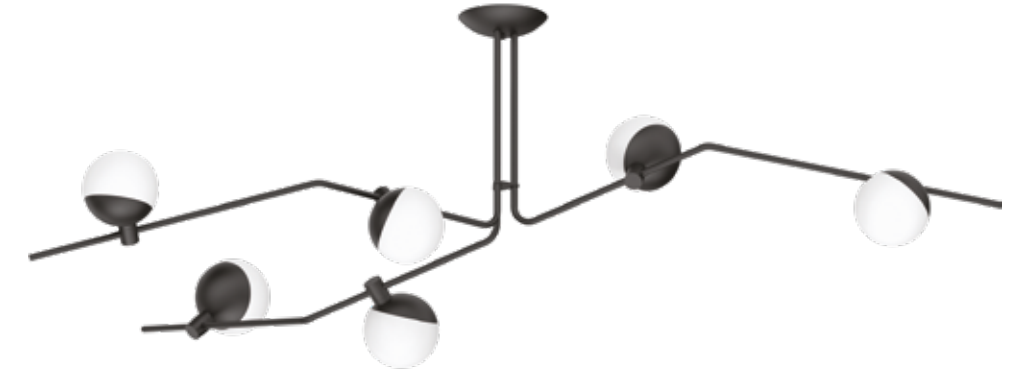

Chandelier Lamp 3

BA-CH3



Madame Bovary

BB



Kiss Me

EE



Morning After

BC



La Lava

ABD



Cocktail Please

ADB



Gone Fishing

AAB



Nighty Night

ABB



Cat's Hat

AEF



Prom Queen

BDE



Dance All Night

BBC



Coney Cone

ABC



Wall Lamp

AB-W



Grupa Studio & Showroom
Popa Dukljanina 1
10000 Zagreb, HR

+385 1 4576 186
www.grupa.com

General Information:
info@grupa.com

Sales:
sales@grupa.com

Photography and Styling:
Dean Franić
Domagoj Kunić
Duško Vlaović
Fredrik Sweger
Hannah Vranko
Jure Živković
Manolo Yllera
Marija Gašparović
Mario Depicolzuane
Marko Mihaljević
Michel Maurice
Relja Ivanić
Santiago Brotons
Saša Antić
Still Life Blogs
Studio na.hili
Vanja Šolin
Zasoby Studio

3D Visualization:
Polymachine
Vinko Pelicarić
Sveto Bačić

Copywriting:
Utorak

Design:
Denis Kovač
Gareth Jones

Print:
Printera

Paper:
Igepa Plana

GRUPA.COM