

Facebook- Twitter- Instagram- Pinterest- Youtube- LinkedIn



**Global Manufacturing and Trading Company S.L**  
Polígono Industrial los Vientos Calle Aliso, parcela nº4 46119, Náquera, Valencia, SPAIN  
T +34 96 160 99 50 F +34 96 160 99 48  
mantra@mantraco.org  
www.mantrailuminacion.com

mAntra

www.mantrailuminacion.com



mAntra



Santiago Sevillano

Mantra colabora con un equipo de diseñadores externos muy diverso, especializados en diversas ramas dentro del mundo del diseño.

Profesionales con experiencia en el sector de la iluminación que aportan soluciones novedosas en el desarrollo de nuevos conceptos, participando en todos los procesos de desarrollo del producto, desde el boceto inicial hasta la concepción del producto final.

Esta gran variedad de estilos que nos ofrecen incide directamente en nuestro catálogo, el cual está compuesto por soluciones que se adaptan a cualquier tipo de estilo o necesidad dentro del mundo de la iluminación.

Nuestro trato con los diseñadores va más allá de un mero trato profesional, confiamos plenamente en su buen hacer y en sus métodos de trabajo que nos aporta frescura e innovación en cada una de nuestras colecciones.



Hugo Tejada

Mantra collabora con un team di designer esterni molto diversi, specializzati in varie branche nel mondo del design.

Professionisti con esperienza nel settore dell'illuminazione che forniscono soluzioni innovative nello sviluppo di nuovi concetti, partecipando a tutti i processi di sviluppo del prodotto, dallo schizzo iniziale alla concezione del prodotto finale.

Questa ampia varietà di stili che ci offre influisce direttamente sul nostro catalogo, che è composto da soluzioni che si adattano a qualsiasi tipo di stile o esigenza nel mondo dell'illuminazione.

Il nostro trattamento con i designer va oltre un semplice trattamento professionale, confidiamo pienamente nel loro buon lavoro e nei loro metodi di lavoro che ci danno freschezza e innovazione in ciascuna delle nostre collezioni.



Santolaria & Llusca

Mantra works with a very diverse team of freelance designers, specialized in different branches of design.

They are a group of highly qualified professionals experience in in the lighting sector, who contribute with original solutions in the development of new concepts; they also participate actively in the whole product development process, from the initial draft to the lasted finishing details.

This wide variety of styles that our designers offer have a direct impact on our catalogues, which are made up of ideas that are adapted to any type of lighting need.

Besides, we take pride in having a great relationship with them, which goes beyond the professional link. We truly rely on their capability and work methods, which have provided, such innovative and stylish collections so far.



José Ignacio Ballester

Mantra collabore avec une équipe de dessinateurs externes très diverse, spécialisés dans différentes branches dans le monde du design.

Des professionnels avec une grande expérience dans le secteur de l'illumination, qui apportent des solutions innovatrices au développement de nouveaux concepts, et participent dans tous les processus de fabrication du produit, depuis le brouillon jusqu'à la conception du produit final.

cette grande variété de styles influence directement notre catalogue, qui est composé de solutions qui s'adaptent à tous les styles ou besoins dans le monde de l'illumination.

notre relation avec l'équipe de designers va plus loin que le contact professionnel, nous avons confiance sur leur savoir-faire, et leur méthodes de travail qui nous apporte fraîcheur et innovation, pour chacune de nos collections.



mAntra

+ 50  
países  
countries

+ 17  
años  
years

+ 2000  
clientes  
customers



Dpto. de diseño y creación de producto  
Product design and development department

Dpto. de gestión comercial y administrativa  
Sales and Administrative department

Sede España, Náquera (Valencia)  
Located Valencia Spain



Base de logística - Distribución  
Warehousing - Distribution



ADN	285
AIRE & STAR	259
AKIRA	509
ALBORÁN	201
ALISIO	51
ANDREA	411
ÁREA	67
ARMONÍA	17
BUCLE	269
CELESTE	79
CINTO	151
CORINTO	143
EGG	381
EOS	389
EOS MUSIC	385
EVE	461
HELIX	139
HEMISFÈRIC	279
INDUSTRIAL	301
INFINITY	231
JARRAS	175
JAZZ	193
KHALIFA	361
KNOT LED	241
LENS	189
LINE NUR	31
LINE INFINITY	41
LINE KNOT	45
Colección	página

LINE SÁHARA	49
LOEWE	431
LUNAS	297
LOOKER	347
LUA	477
MADAGASCAR	119
MANTA	207
MARA	499
MAUI	309
MEDITERRÁNEO	353
MURAL	87
NINETTE	491
NÓRDICA II	323
NÓRDICA	331
NUR	211
OLIMPIA	101
ORBITAL	293
ORGÁNICA	313
PAOLA	423
QUATRO II	377
RING	169
SABINA	395
SÁHARA	249
SONATA	57
TIFFANY	445
TSUNAMI	131
ZACK	367
Colección	página

Lámparas & Colgantes - Pendant Lamp

NUR  
212

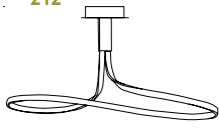

INFINITY  
233

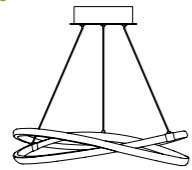

SÁHARA  
250

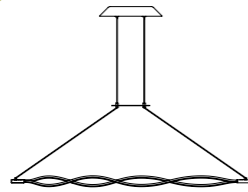

KHALIFA  
363

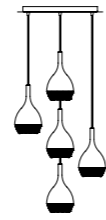

NURLINE  
32

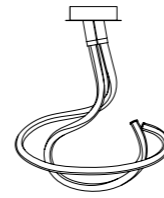

INFINITYLINE  
43

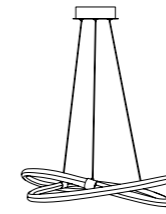

SÁHARALINE  
48

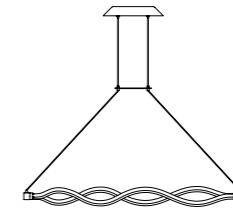

TSUNAMI  
136

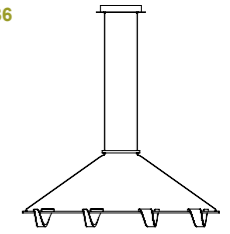

LUNAS  
296

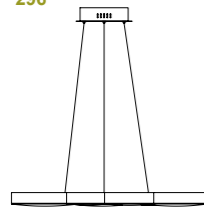

ZACK  
368

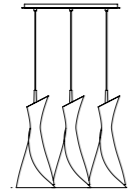

E05  
390

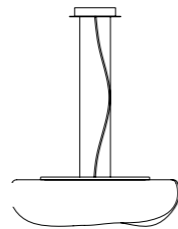

MEDITERRÁNEO  
354

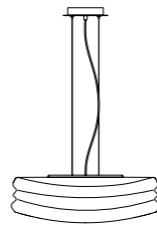

CINTO  
154

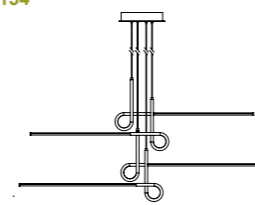

CELESTE  
80



MADAGASCAR  
120

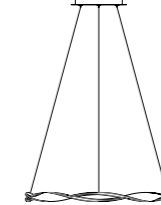

CORINTO  
147

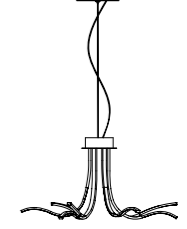

SONATA  
60

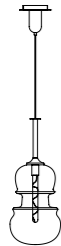

JARRAS  
178

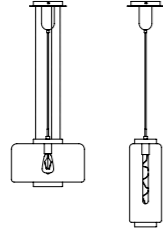

JARRAS  
180

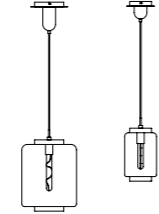

LENS  
190

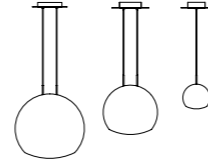

JAZZ  
195

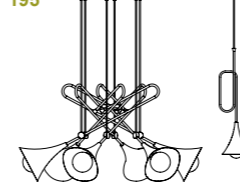

ALBORÁN  
202

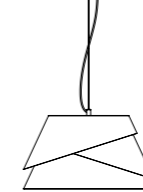

MANTA  
208

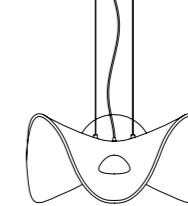

MAUI  
310

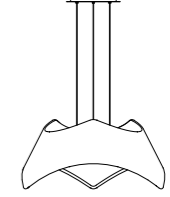

SABINA  
404



SABINA  
402

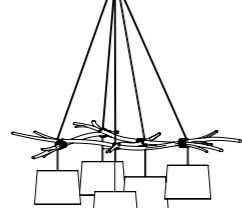

EVE  
462

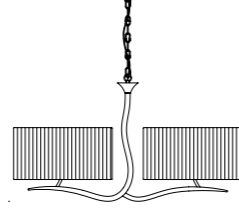

LUA  
478

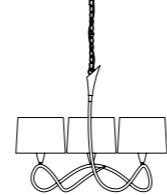

LOOKER  
348

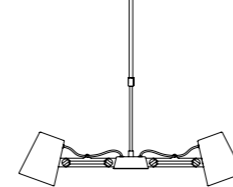

BUCLE  
270

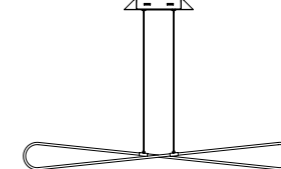

STARLED  
264

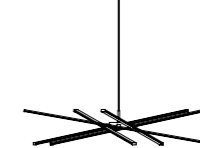

AIRE LED  
260



LOEWE  
434

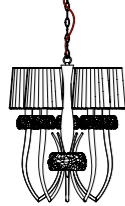

PAOLA  
424



TIFFANY  
446

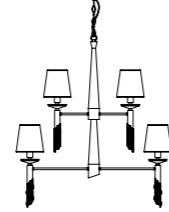

HEMISFÉRICO  
280

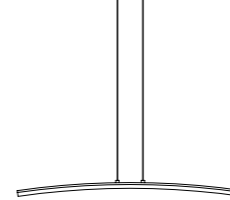

NORDICA II  
326

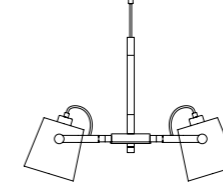

NÓRDICA  
334

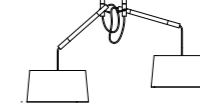

INDUSTRIAL  
302

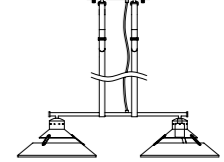

MARA  
500

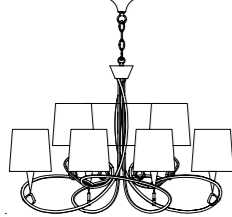

NINETTE  
492

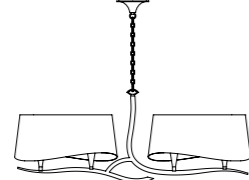

ANDREA  
414



AKIRA  
510

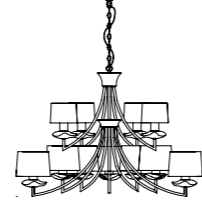

ADN  
286

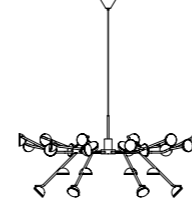

ORBITAL  
292



RING  
172



ORGÁNICA  
314





Apliques - Wall Lamp

SABINA  
407

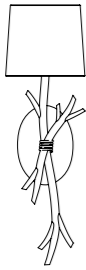

ANDREA  
409



ANDREA  
419

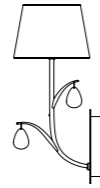

PAOLA  
428



PAOLA  
428



LOEWE  
440

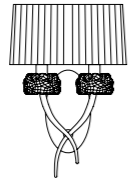

LOEWE  
441

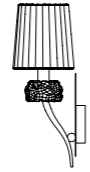

EVE  
470

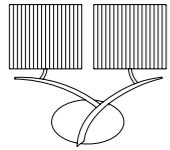

EVE  
472

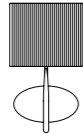

EVE  
470

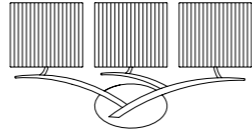

TIFFANY  
456

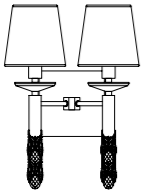

TIFFANY  
456

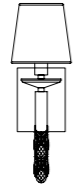

LUA  
484

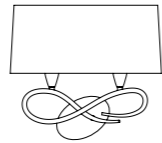

LUA  
485



NINETTE  
494

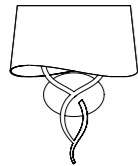

NINETTE  
494



MARA  
404

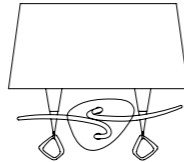

MARA  
404



AKIRA  
516

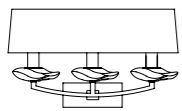

AKIRA  
516

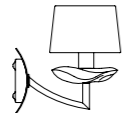

AKIRA  
516

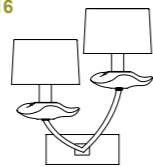

Apliques - Wall Lamp

ARMONÍA  
25



NURLINE  
38



KNOTLINE  
44



MURAL  
92

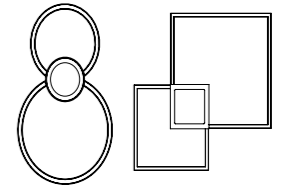

OLIMPIA  
114

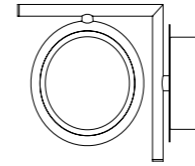

CORINTO  
148



CINTO  
165

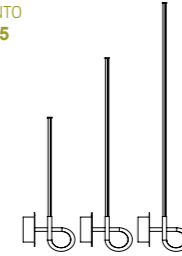

JAZZ  
199

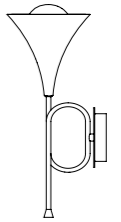

KNOTLED  
245



NUR  
226



SÁHARA  
256



BUCLE  
272

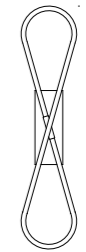

HEMISFÉRIC  
283



TSUNAMI  
132

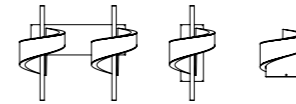

ADN  
288

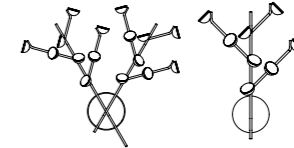

ADN  
289

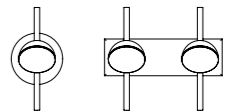

INDUSTRIAL  
306

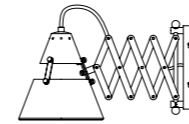

NÓRDICA II  
328

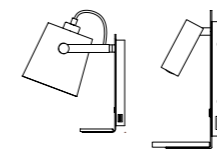

NÓRDICA II  
329

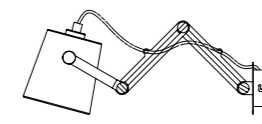

NÓRDICA  
338

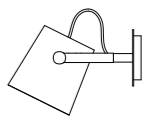

LOOKER  
351

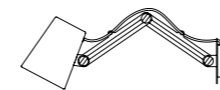

LOOKER  
351



ZACK  
372



EOS  
392

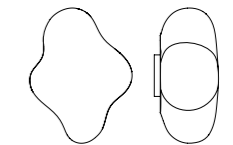

Plafón - Ceiling Lamp

LUNAS  
298

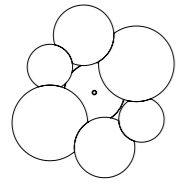

LUNAS  
298

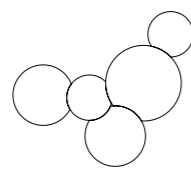

LUNAS  
299

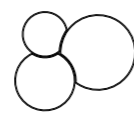

LUNAS  
299



ORGÁNICA  
318



ORGÁNICA  
318



NÓRDICA  
342

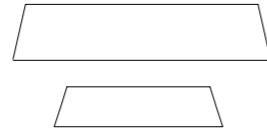

NÓRDICA  
342

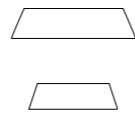

MEDITERRÁNEO  
356

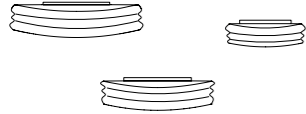

QUATRO II  
378

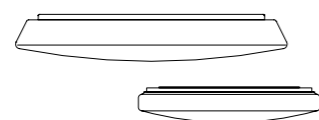

EGG  
382

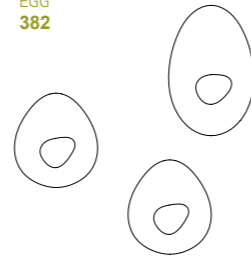

EOS MUSIC  
386

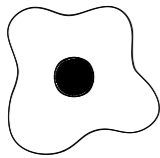

EOS  
393

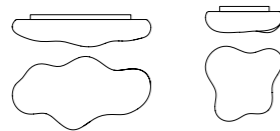

SABINA  
408

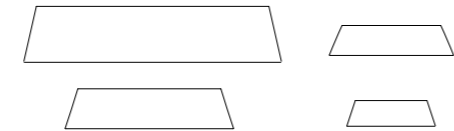

EVE  
466

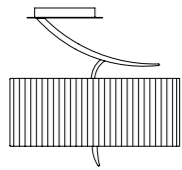

LOEWE  
438

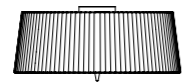

LUA  
482

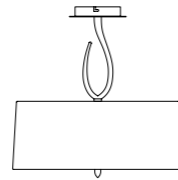

NINETTE  
495

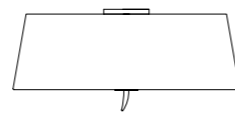

MARA  
502

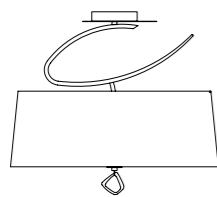

MARA  
503

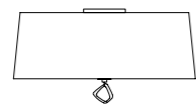

AKIRA  
514

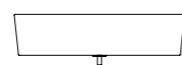

NINETTE  
495

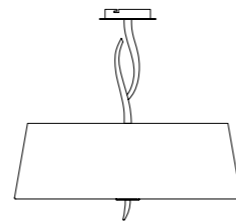

ARMONIA  
20



TSUNAMI  
133

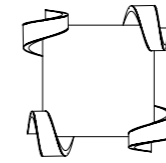

ÁREA  
68

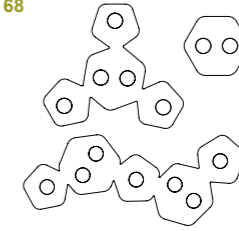

ALISIO  
52

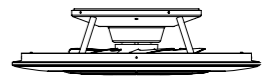

NURLINE  
32

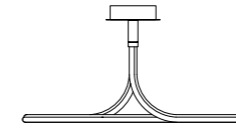

INFINITYLINE  
42

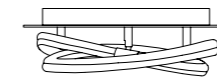

OLIMPIA  
110

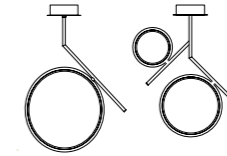

AIRE & STAR LED  
263 - 267

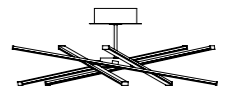
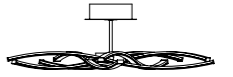

CORINTO  
146

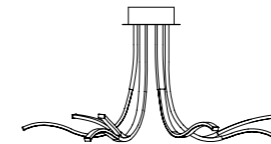

CINTO  
155

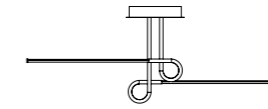

CINTO  
155

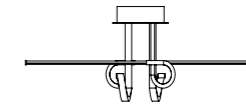

CINTO  
164

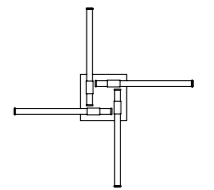

JAZZ  
194

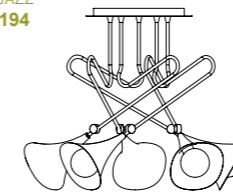

NUR  
226

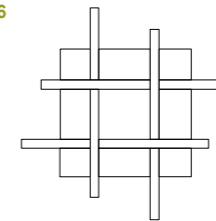

INFINITY  
232

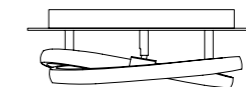

KNOT LINE  
46

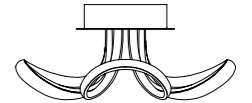

KNOTLED  
242

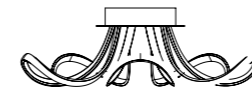

KNOTLED  
244

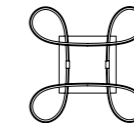

BUCLE  
273



BUCLE  
274

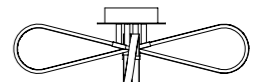

HEMISFÉRIC  
282

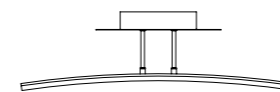

ADN  
290

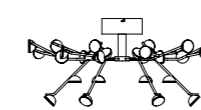

MURAL  
88

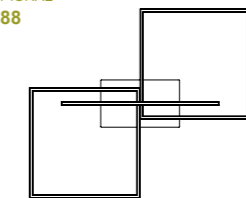

ORBITAL  
294

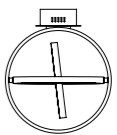

Sobremesa - Table Lamp



Pie de Salón - Floor Lamp

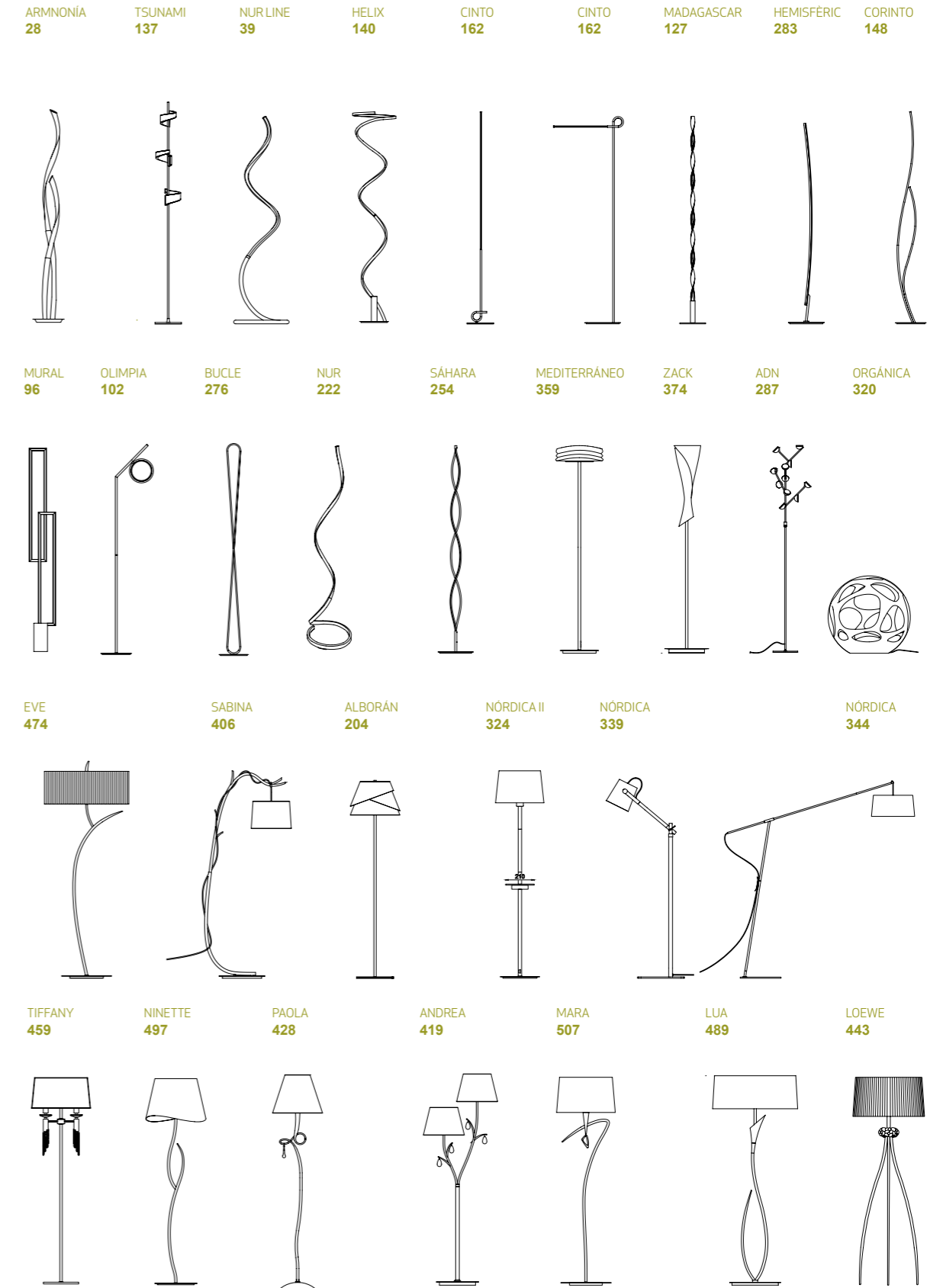



# ARMONÍA

Colección de iluminación, diseñada por Jose Ignacio Ballester para Mantra, donde fusiona armónicamente looks clásicos y modernos, reinventando la manera de presentar la luz led mediante la fantasía tridimensional de curvas y líneas mínimas dibujadas en el espacio. Su ánima de doble tira de led se alberga dentro de su perfil oval acrílico personalizado; Termo-curvado para llegar a sus agradables formas, transmitiendo así delicadeza visual decorativa, incluso con sus elementos apagados, luciendo de manera eficaz en funcionamiento para expandir sus lumens orbitalmente. Versiones a techo en distintos formatos, a pared, como auxiliares de sobremesa o como pie de salón conforman ARMONÍA, esta especial colección de iluminación para conquistar los más sofisticados entornos y los más exigentes ambientes.

*A collection of lightings, designed by José Ignacio Ballester for Mantra, where modern and classical looks are fused, reinventing the way to present the light through a curved tridimensional fantasy and minimalistic lines drawn into space. Its double-strip bore is harboured within its personalised oval acrylic outline; thermo-curved in order to achieve its stylish forms, transmitting so its decorative visual delicacy, even when is is turned off, flaunting efficiently when functioning to expand its lumens orbitally. Ceiling versions in different formats, Wall, Table or Floor lamps make up ARMONÍA, this special lighting collection that will conquer the most sophisticated and exigent ambiances.*

José Ignacio Ballester

OAMI-006317376 - 0015-0016 - 0017 - 0018 - 0019 - 0020 - 0021





Plafón - Ceiling Lamp

Blanco/Cromo-White/Chrome

6720  
LED 60W 3000K 4500lm

Plafón - Ceiling Lamp

Blanco/Titanio-White/Titanium

6790  
LED 60W 3000K 4500lm

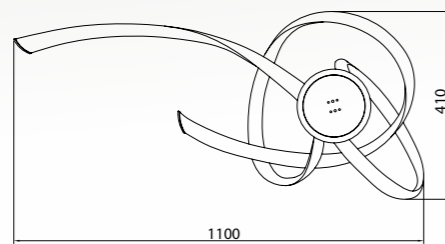
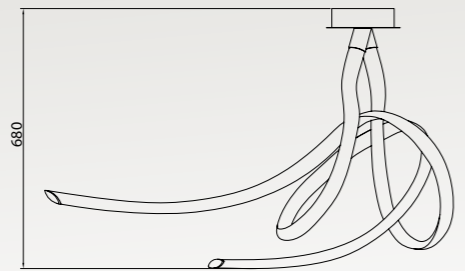

220-240V-50/60Hz CRI >80 PC/Aluminio/Hierro - PC/Aluminum/Iron





**Plafón - Ceiling Lamp**  
Blanco/Cromo- White /Chrome

**6724**  
LED 40W 3000K 3000 lm

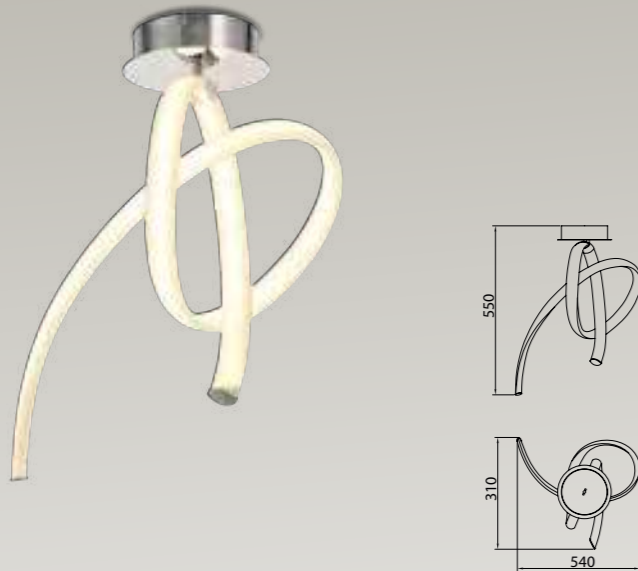

**Plafón - Ceiling Lamp**  
Blanco/Titanio- White /Titanium

**6794**  
LED 40W 3000K 3000 lm Dimmable



**Plafón - Ceiling Lamp**  
Blanco/Cromo- White /Chrome

**6721**  
LED 60W 3000K 4500lm



**Plafón - Ceiling Lamp**  
Blanco/Titanio- White /Titanium

**6791**  
LED 60W 3000K 4500lm Dimmable



**Plafón - Ceiling Lamp**  
Blanco/Cromo- White /Chrome

**6725**  
LED 25W 3000K 1875lm

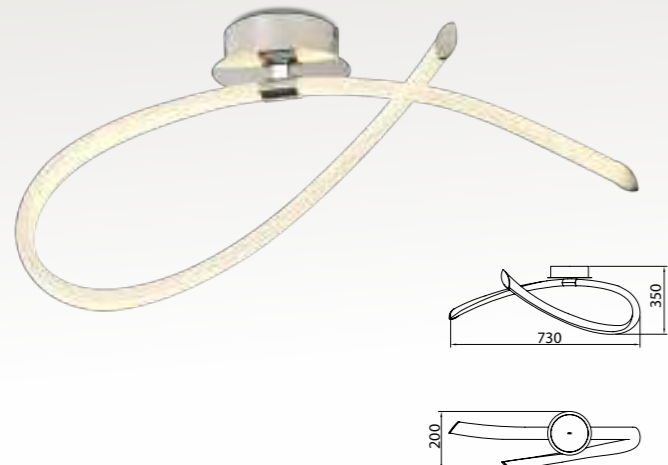

**Plafón - Ceiling Lamp**  
Blanco/Titanio- White /Titanium

**6795**  
LED 25W 3000K 1875lm Dimmable



**Plafón - Ceiling Lamp**  
Blanco/Cromo- White /Chrome

**6731**  
LED 40W 3000K 3000 lm

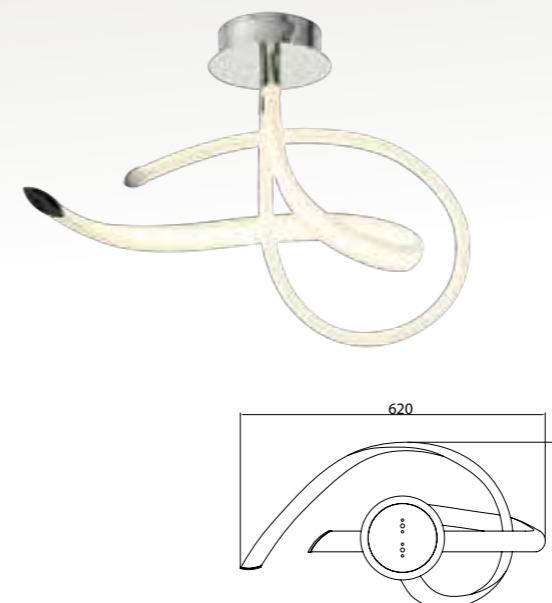

**Plafón - Ceiling Lamp**  
Blanco/Titanio- White /Titanium

**6801**  
LED 40W 3000K 3000 lm Dimmable

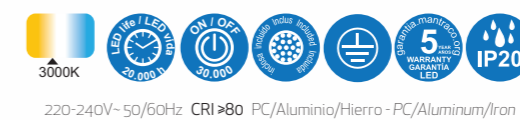
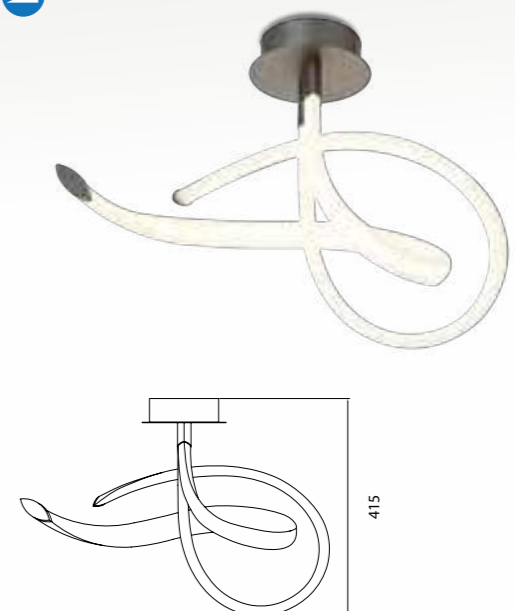

220-240V-50/60Hz CRI >80 PC/Aluminio/Hierro - PC/Aluminum/Iron

220-240V-50/60Hz CRI >80 PC/Aluminio/Hierro - PC/Aluminum/Iron



**Plafón - Ceiling Lamp**

Blanco/Cromo- White /Chrome

**6723**

LED 50W 3000K 3750lm



**Plafón - Ceiling Lamp**

Blanco/Titanio- White /Titanium

**6793**

LED 50W 3000K 3750lm Dimmable

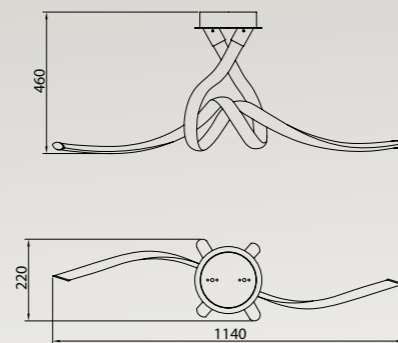

220-240V-50/60Hz CRI >80 PC/Aluminio/Hierro - PC/Aluminum/Iron





Sobremesa - Table Lamp

**6729** Blanco/Cromo- White/Chrome  
LED 10W 3000K 750lm

**6799** Blanco/Titanio- White/Titanium  
LED 10W 3000K 750lm Dimmable

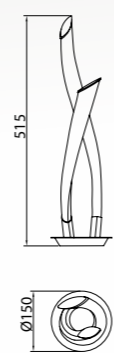
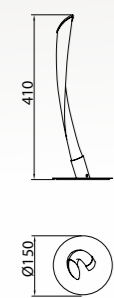

Sobremesa - Table Lamp

**6728** Blanco/Cromo- White/Chrome  
LED 18W 3000K 1350lm

**6798** Blanco/Titanio- White/Titanium  
LED 18W 3000K 1350lm Dimmable

Aplique - Wall Lamp

**6726** Blanco/Cromo- White/Chrome  
LED 18W 3000K 1350lm

**6796** Blanco/Titanio- White/Titanium  
LED 18W 3000K 1350lm Dimmable

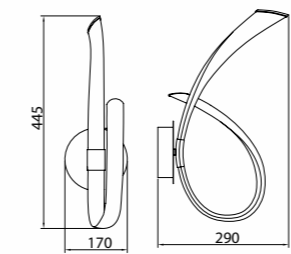

Aplique - Wall Lamp

**6727** Blanco/Cromo- White/Chrome  
LED 12W 3000K 900lm

**6797** Blanco/Titanio- White/Titanium  
LED 12W 3000K 900lm Dimmable

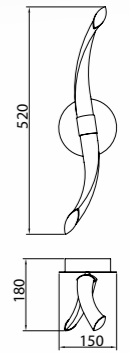

**Plafón - Ceiling Lamp**

Blanco/Cromo- White /Chrome

**6722**

LED 60W 3000K 4500lm

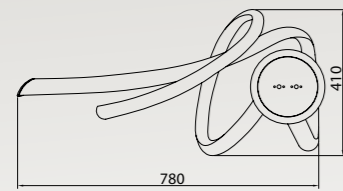
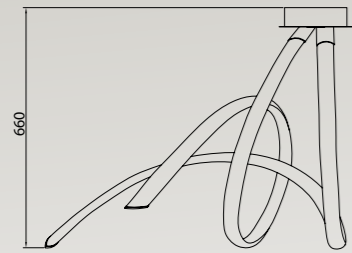

**Plafón - Ceiling Lamp**

Blanco/Titanio- White /Titanium

**6792**

LED 60W 3000K 4500lm Dimmable



220-240V~50/60Hz CRI>80 PC/Aluminio/Hierro - PC/Aluminum/Iron



**Pie de Salón - Floor Lamp**  
Blanco/Cromo- White/Chrome

**6730**  
LED 30W 3000K 2250lm  
Dimmable



**Pie de Salón - Floor Lamp**  
Blanco/Titanio- White/Titanium

**6800**  
LED 30W 3000K 2250lm  
Dimmable

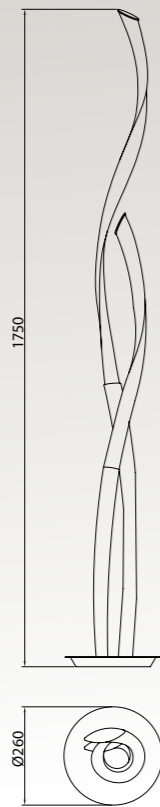

220-240V~50/60Hz CRI>80 PC/Aluminio/Hierro - PC/Aluminum/Iron



# Line

Mantra reúne una serie de sus modelos más exitosos en una nueva colección con el hilo conductor de una novedosa propuesta estética y eficaz.

Persiguiendo una forma de iluminar con leds de manera eficiente a 360°, sacando partido a cada uno de sus lumen, *LINE*, propone un perfil acrílico con ánima difusora que expande de manera homogénea todo el torrente de luz interior, evitando sombras y anti-estéticos puntos oscuros para que no distraigan la armonía de sus curvas en sus elementos de iluminación.

Es por ello que modelos ya sobradamente conocidos de las colecciones *NUR*, *INFINITY*, *KNOT* y *SAHARA*, vestirán sus giros con el nuevo perfil compartiendo espacio en la propuesta *LINE*.

*Mantra gathers on this series traits of its most successful collections, with the common thread of a novel aesthetic and efficient proposal. Pursuing a productive led-illuminating 360 degrees system, making the most of all its lumens, it proposes an acrylic profile with a diffusing bore that spreads homogeneously the whole inner light flow, avoiding so any shadows or antiaesthetic black points, so that they do not disturb the harmony of its curves in its lighting elements. That is why the well-known collections NUR, INFINITY, KNOT and SAHARA will.*

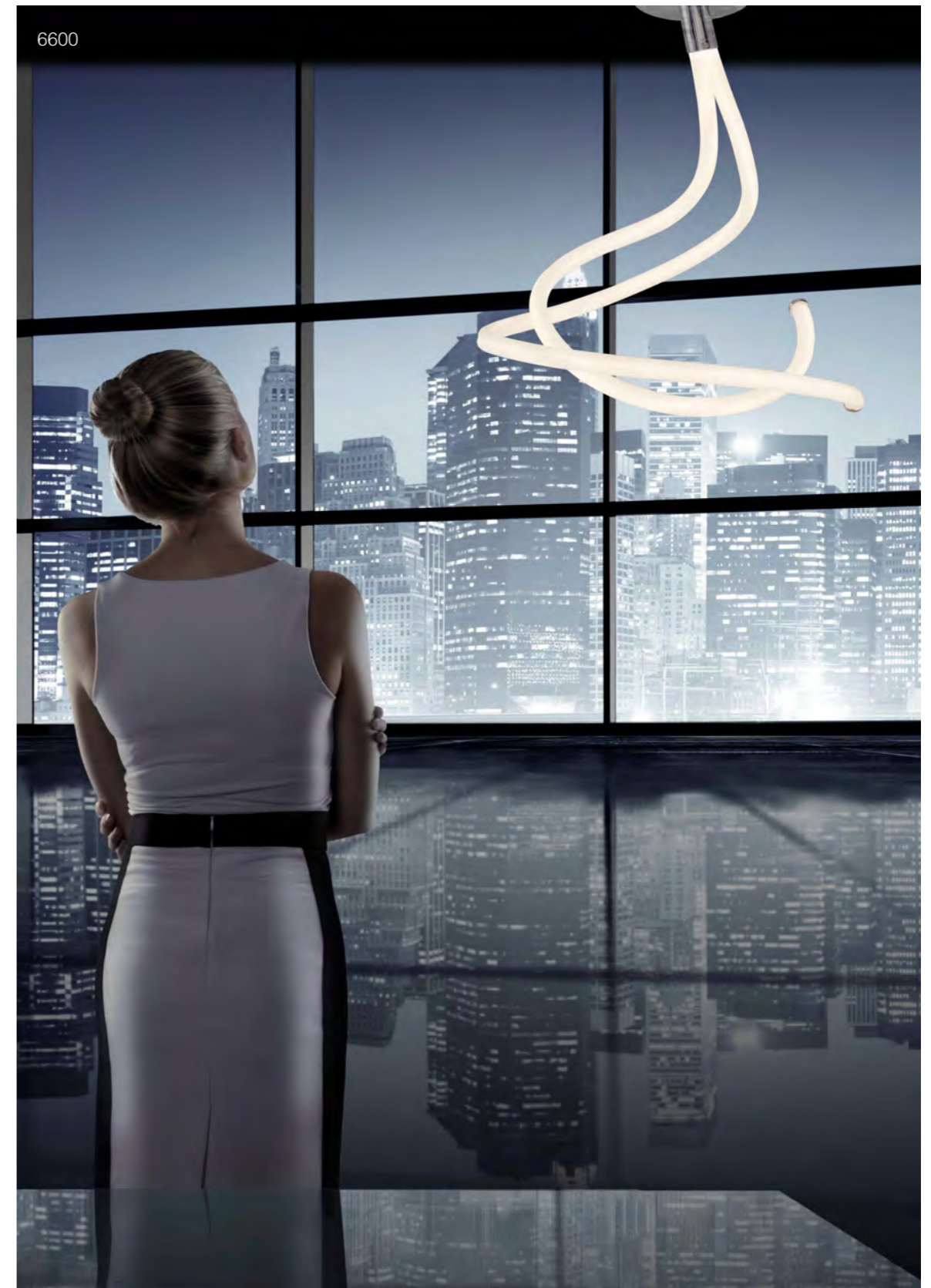

OAMI - 006317376-0009 - 0010 - 0011 - 0012 - 0013 - 0014



**Lámpara - Pendant Lamp**  
Cromo / Blanco - Chrome / White

**6600**  
LED 50W 3000K 3750 lm

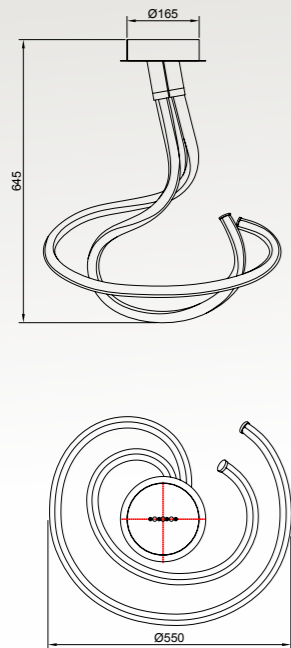

**Plafón - Ceiling Lamp**  
Cromo / Blanco - Chrome / White

**6601**  
LED 40W 3000K 3000 lm

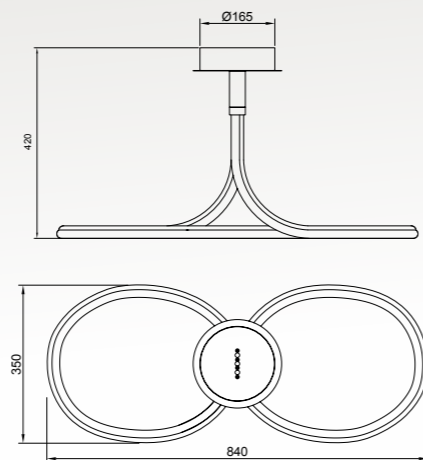

**Plafón XL - Ceiling Lamp XL**  
Cromo / Blanco - Chrome / White

**6602**  
LED 50W 3000K 3750 lm

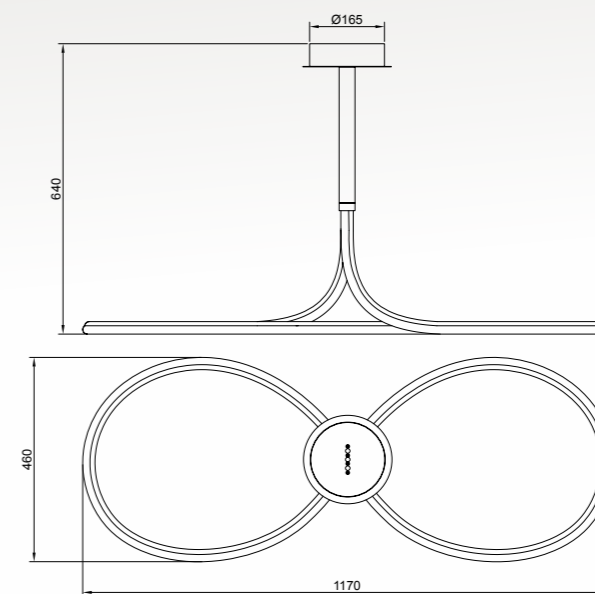

220-240V-50/60Hz CRI>80 Acero / Acrílico - Steel / Acrylic



220-240V-50/60Hz CRI>80 Acero / Acrílico - Steel / Acrylic

Nur Line  
José Ignacio Ballester

6602









# Nur Line

Santiago Sevillano

## Sobremesa - Table Lamp

Cromo / Blanco - Chrome / White  
Clase: II  
100-240V

**6604**

LED 12W 3000K 900 lm

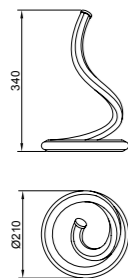

## Aplique - Wall Lamp

Cromo / Blanco - Chrome / White  
Clase: I  
220-240V

**6603**

LED 12W 3000K 900 lm

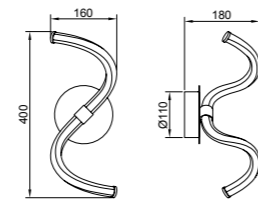

## Pie De Salón - Floor Lamp

Cromo / Blanco - Chrome / White  
Clase: II  
220-240V

**6605**

LED 20W 3000K 1500 lm

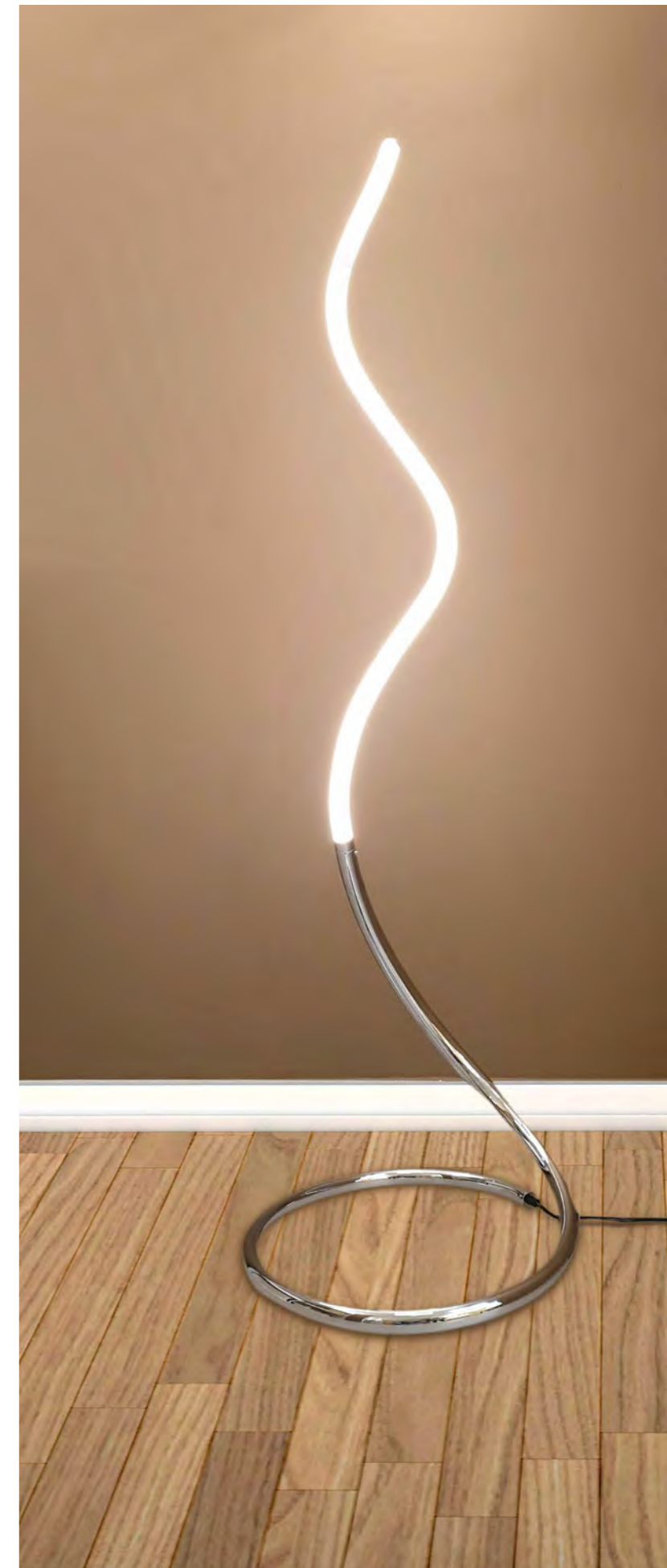
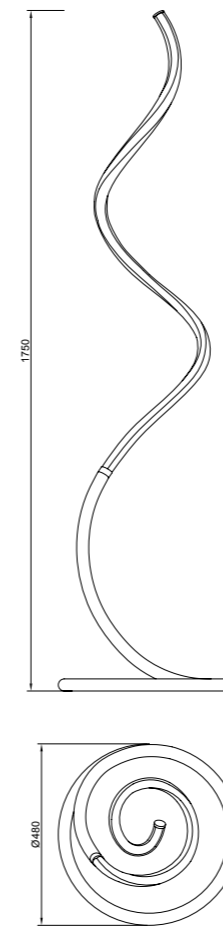

220-240V-50/60Hz CRI>80 Acero / Acrílico - Steel / Acrylic





Infinity Line  
José Ignacio Ballester

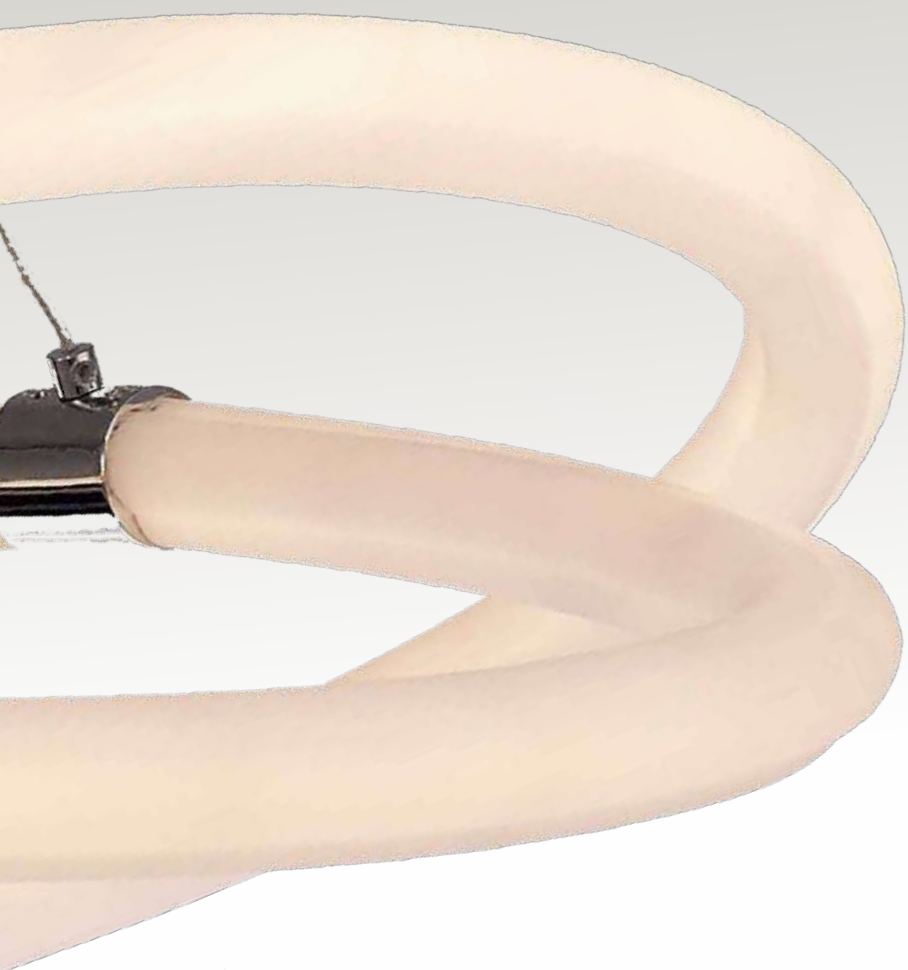

6608 - 6607





**Plafón - Ceiling Lamp**  
Cromo / Blanco - Chrome / White

**6609**  
LED 30W 3000K 2250 lm

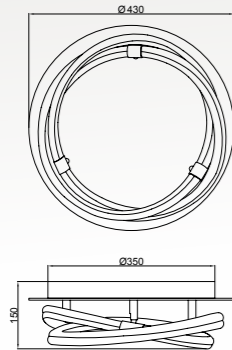

**Lámpara - Pendant Lamp**  
Cromo / Blanco - Chrome / White

**6608**  
LED 42W 3000K 3150 l

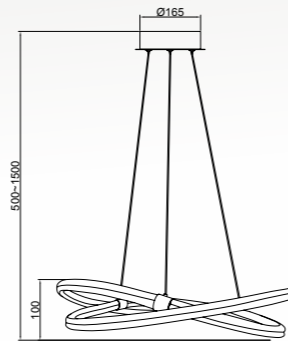
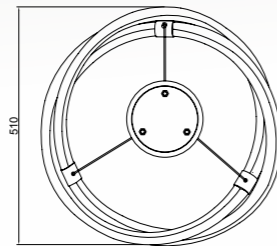
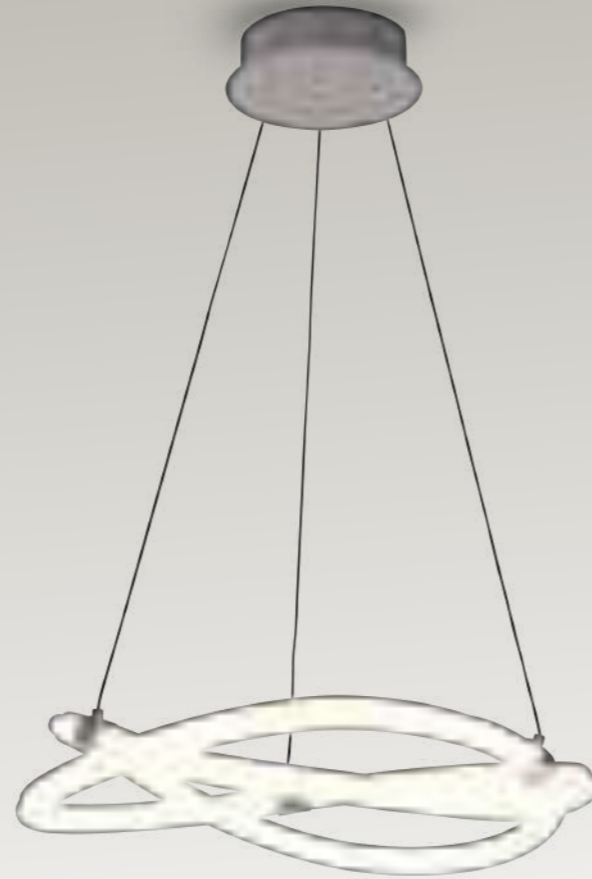

**Lámpara - Pendant Lamp**  
Cromo / Blanco - Chrome / White

**6607**  
LED 60W 3000K 4500 lm

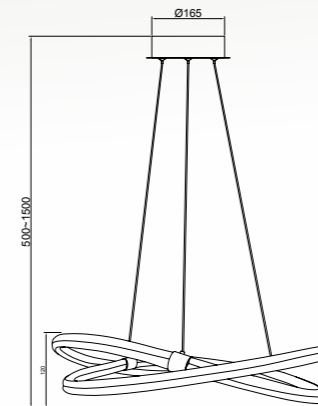
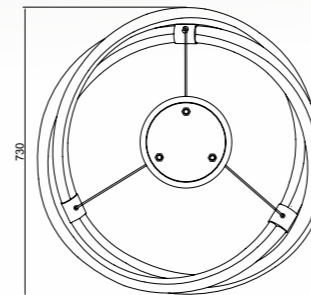



**Knot Line**  
Santiago Sevillano

**Aplique - Wall Lamp**  
Cromo / Blanco - Chrome / White

**6617**  
LED 12W 3000K 900 lm

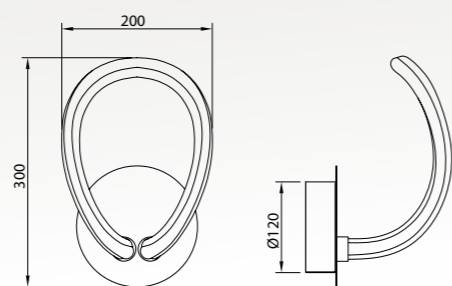

220-240V-50/60Hz CRI>80 Acero / Acrílico - Steel / Acrylic



6616 -6617





Plafón - Ceiling Lamp  
Cromo / Blanco - Chrome / White

6616  
LED 40W 3000K 3000 lm

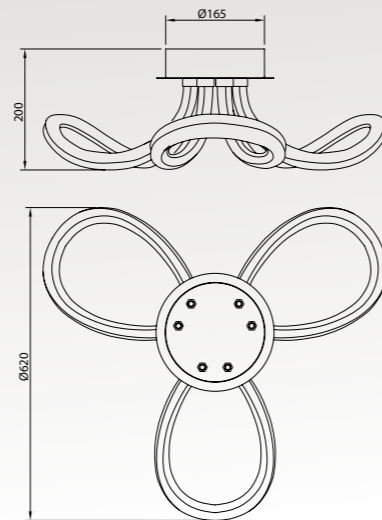

Plafón - Ceiling Lamp  
Cromo / Blanco - Chrome / White

6615  
LED 60W 3000K 4500 lm

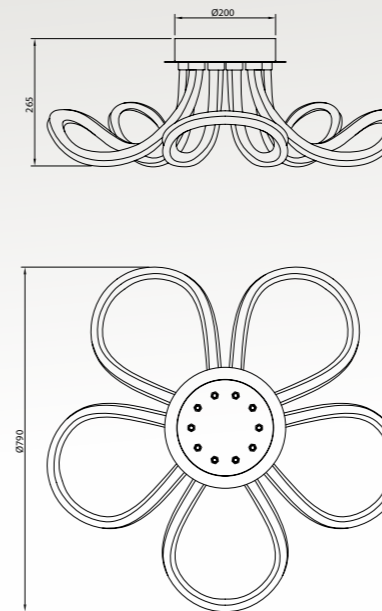

220-240V-50/60Hz CRI>80 Acero / Acrílico - Steel / Acrylic



100-240V-50/60Hz CRI>80 Acero / Acrílico - Steel / Acrylic





Lámpara - *Pendant Lamp*  
Cromo / Blanco - *Chrome / White*

6612  
LED 40W 3000K 3000lm

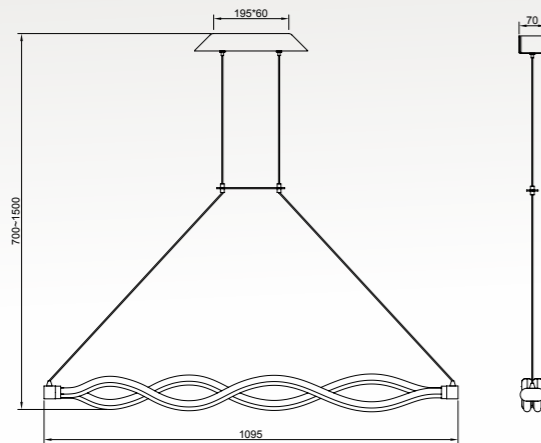
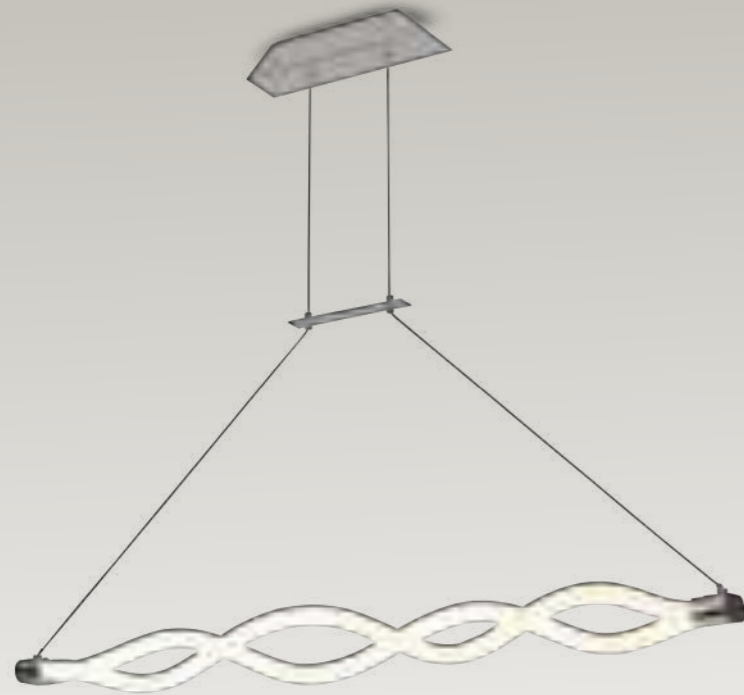

220-240V-50/60Hz CRI >80 Acero / Acrílico - Steel / Acrylic

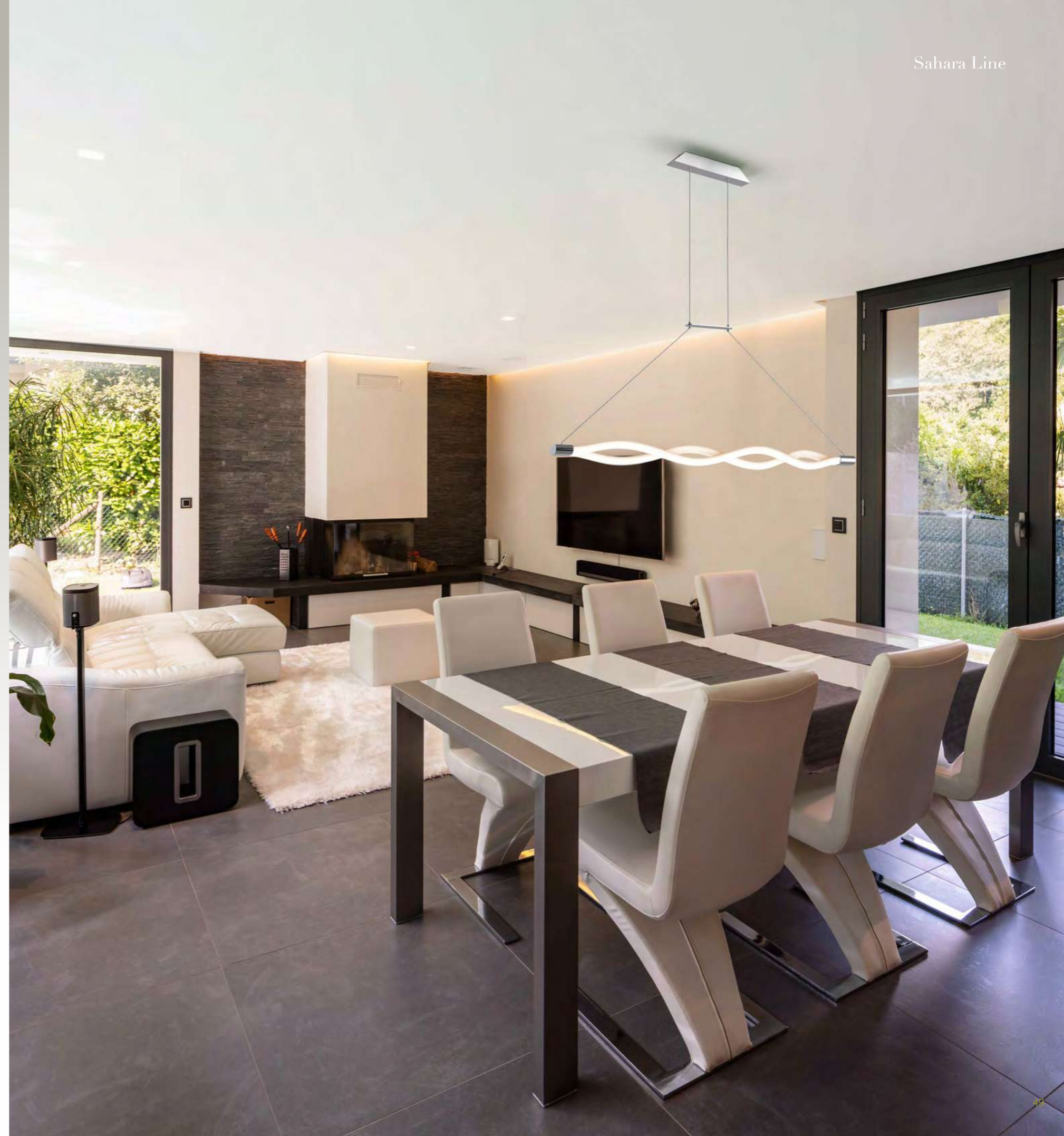



## ALISIO

ALISIO es una nueva propuesta de Mantra, para irrumpir en el sector de los elementos de ventilación, intentando como siempre, aportar un plus de originalidad y frescura con su diseño. Diseño vanguardista y decorativo, que por dimensiones no dificulta estéticamente la visión del lugar al ser instalado, con un anclaje fácil y seguro a techo. Su estética minimalista alberga sus varias funciones, como refrescar y ventilar, caldear e iluminar eficazmente las estancias. Ideal para los dormitorios y zonas de descanso por su adecuación luminosa al efecto y también por su motor DC silencioso y eficiente en verano refrescando, y con su "función inverter" (en posición de giro contrario) que permite recoger el aire caliente y distribuirlo homogéneamente por la estancia en invierno. Además al tener distintas intensidades y velocidades, también puede instalarse en ambientes de mayor superficie, como salones, cocinas o zonas de recreo. Dada su configuración compacta y por su diseño, aporta un plus de seguridad escondiendo sus transparentes aspas, de manera estética y discreta, evitando peligros y accidentes involuntarios. Dimmable con cambio de temperatura de color y con distintas velocidades con su motor DC, controlado todo ello desde su mando a distancia (incluido) o con la opción, si se desea, de realizarlo con la APP vía bluetooth desde su dispositivo móvil.

Por todo ello ALISIO, refunde todo lo mejor de la ventilación e iluminación en una realidad estética y eficaz.

*Alisio is a new proposal by Mantra, entering the ventilation sector for the first time, aiming to contribute with a bonus of originality and freshness in its design. An avant-garde and decorative design that given its dimension, does not hinder the vision of the room when installed, with a safe and easy moorings to ceiling.*

*Its minimalistic style is able to embrace its various functions, refreshing, ventilating, warming up and effectively illuminating any room. Ideal for bedrooms and resting estances due to the lighting possibilities as well as its silent DC engine, able to fresh up the air in summer and with its "inverter" function (in rear position), which allows to pick warm air and distribute it homogeneously in Winter. Furthermore, through its different intensities and speeds, it can be installed in bigger estances, such as living or dining-rooms, kitchens or play areas. Thanks to its compact configuration and design, it offers a safety bonus, hiding its transparent blades in an aesthetic and discreet way, so avoiding any potential danger. Dimmable, with the possibility to change color and temperature and with different speeds in its DC engine, all of it controlled through its remote control (included) or with the possibility to handle it through your mobile phone app via bluetooth.*

*In short, ALISIO gathers the best of both the ventilation and lighting fields in an efficient and aesthetic reality.*

Mantra Team



Registrado OAMI 006190500-001



Alisio  
Mantra Team

**Ventilador Plafón - Fan Ceiling Lamp**  
Blanco Cromo - White Chrome

**6705**  
LED 70W 2700-4000-5000K 4900 lm  
Ventilador 35W

**Ventilador Plafón - Fan Ceiling Lamp**  
Cuero - Antique Brass

**6707**  
LED 70W 2700-4000-5000K 4900 lm  
Ventilador 35W

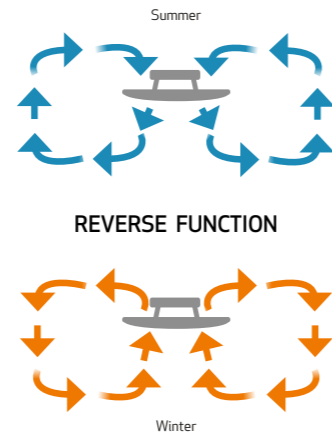
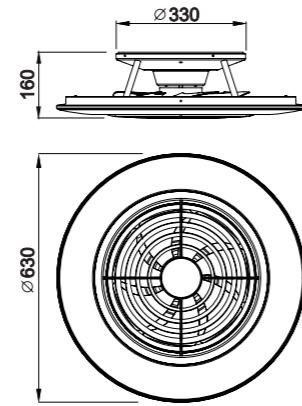

220-240V- 50/60Hz CRI>80 Metal/ABS - Difusor/Acrylic





Alisio  
Mantra Team

**Ventilador Plafón - Fan Ceiling Lamp**  
Plata Cromo - Chrome Silver

**6706**  
LED 70W 2700-4000-5000K 4900 lm  
Ventilador 35W



**App ALISIO**

(Apple IOS y Android system, Bluetooth)

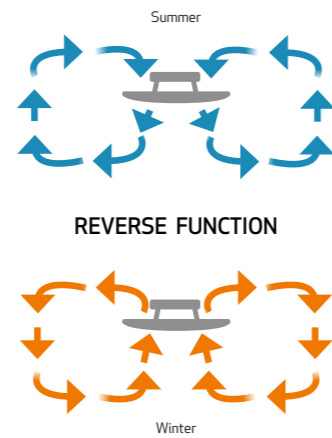
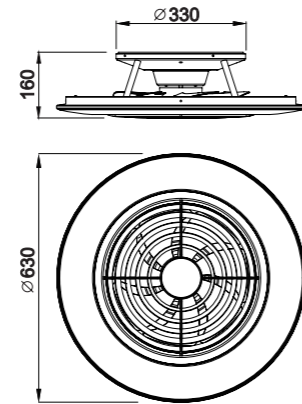







## SONATA

*Sonata* tiene el espíritu de un instrumento solista. Como la forma musical de su nombre, ha sido creada para lucirse con escaso acompañamiento, o bien protagonizando un solo acaparador de miradas. Es una oda a la música, a la cuerda, a la emoción. Y, siguiendo el ejemplo de su inspiración, Sonata llena el espacio con su luz, tal y como lo hace el violín con sus melodías.  
Un solo que no te querrás perder.

*"Sonata" conveys the spirit of an instrument soloist. As its name suggests, it has been created to stand out with little need of accompaniment, or to be the center of all looks. It is a visual ode to music, cord and emotion. Following the example of its inspiration, Sonata fills the space with the light transparencies, as the violin does with its cords. A solo that you will not be willing to miss.*

Santiago Sevillano

6695







Colgante - Pendant Lamp  
Bronce - Bronze

**6690**  
1x E27 máx.40W/no incl

Colgante - Pendant Lamp  
Cromo/Grafito - Chrome/Graphite

**6691**  
1x E27 máx.40W/no incl

Colgante - Pendant Lamp  
Cobre - Copper

**6692**  
1x E27 máx.40W/no incl

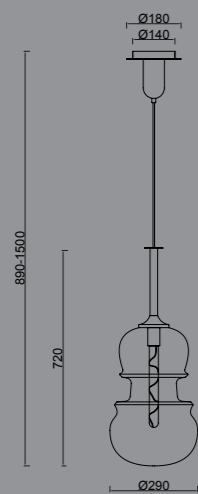

220-240V-50/60Hz Acero / Cristal - Steel / Glass



Colgante - Pendant Lamp  
Bronce - Bronze

**6693**  
1x E27 máx.40W/no incl



Colgante - Pendant Lamp  
Cromo/Grafito - Chrome/Graphite

**6694**  
1x E27 máx.40W/no incl



Colgante - Pendant Lamp  
Cobre - Copper

**6695**  
1x E27 máx.40W/no incl

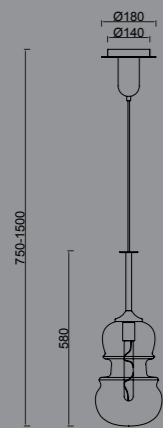

220-240V-50/60Hz Acero / Cristal - Steel / Glass



Colgante - Pendant Lamp  
Bronce - Bronze

Colgante - Pendant Lamp  
Cromo/Grafito - Chrome/Graphite

Colgante - Pendant Lamp  
Cobre - Copper

**6696**  
1x E27 máx.40W/no incl

**6697**  
1x E27 máx.40W/no incl

**6698**  
1x E27 máx.40W/no incl

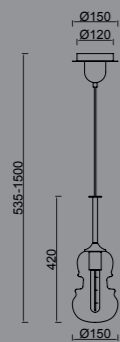

220-240V-50/60Hz Acero / Cristal - Steel / Glass



## ÁREA

La nueva tendencia de elementos de iluminación a techo pasa por la integración máxima de estos al efecto intentando, que sean una mínima pincelada que ilumine y se funda en el entorno.

José Ignacio Ballester nos propone *área* una colección de asimetría y grafismo mínimo.

Con la posibilidad de coordinaciones compositivas inusual entre sus elementos. Elementos que desprenden una ligereza decorativa tanto en sus formas como en su luz;

De fácil instalación y mantenimiento dada su estructura de ensamblaje magnético, que nos proporcionan un torrente de luz mediante sus GX53 en sus diferentes disposiciones (de una, dos, cuatro, cinco y siete luces).

Estructuras éstas decoradas en acabado blanco epóxi. Por todo ello *ÁREA* será protagonista en tu estancia elegida, de manera funcional, minimalista y discreta.

*The new trend in ceiling lightings is based on their highest integration, considering them as a minimum stroke that enlightens and add life to the atmosphere. José Ignacio Ballester presents "Area", a collection of minimal assymetry, with the possibility of unusual compositive coordinations which offer a decorative lightness in its forms and light; It is easy to instal and maintain, given its magnetic assembly structure, which provides a source of light through its GX53 in different dispositions(one, two, four, five and seven lights).The structure is done in white epoxi finish.*

José Ignacio Ballester

6641



**Plafón - Ceiling Lamp**  
Blanco Arena - Sand White

**6640**  
7x GX53 máx.9W/no incl

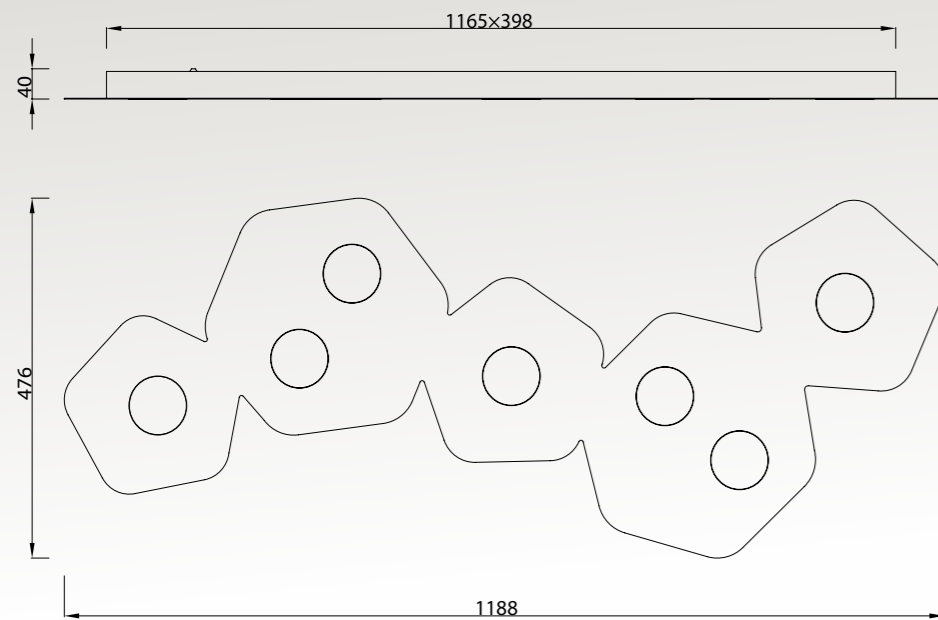

Bombillas Recomendadas  
Suggested Bulbs



**R09224** 3000K  
**R09225** 4000K



220-240V-50/60Hz Acero / Acrílico - Steel / Acrylic

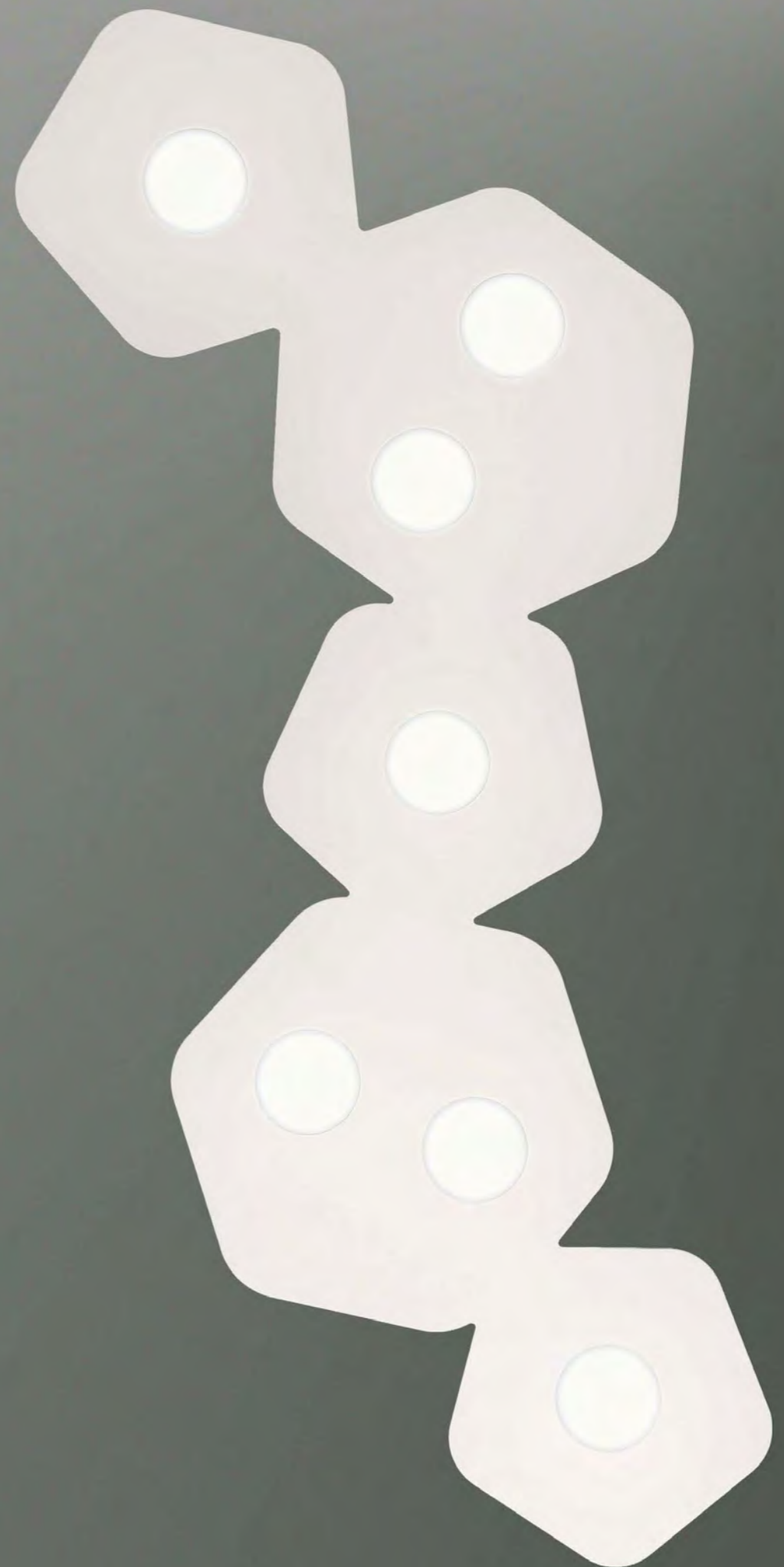







Plafón - Ceiling Lamp  
Blanco Arena - Sand White

6641  
5x GX53 máx.9W/no incl

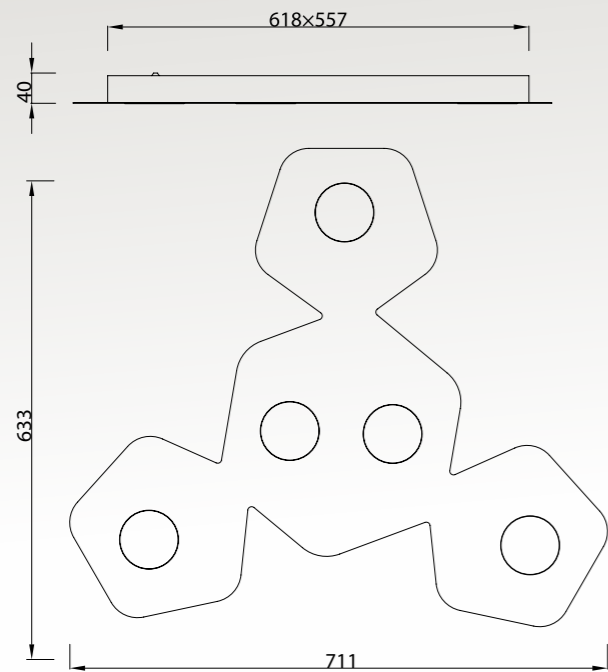

Bombillas Recomendadas  
Suggested Bulbs



R09224 3000K  
R09225 4000K

pág. 519



220-240V-50/60Hz Acero / Acrílico - Steel / Acrylic





Plafón - Ceiling Lamp  
Blanco Arena - Sand White

6642  
4x GX53 máx.9W/no incl

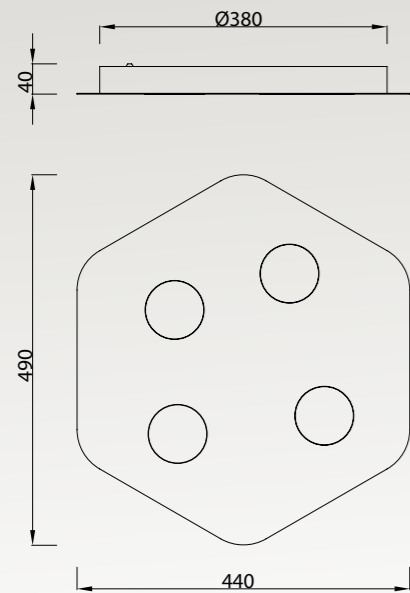

Bombillas Recomendadas  
Suggested Bulbs



R09224 3000K  
R09225 4000K

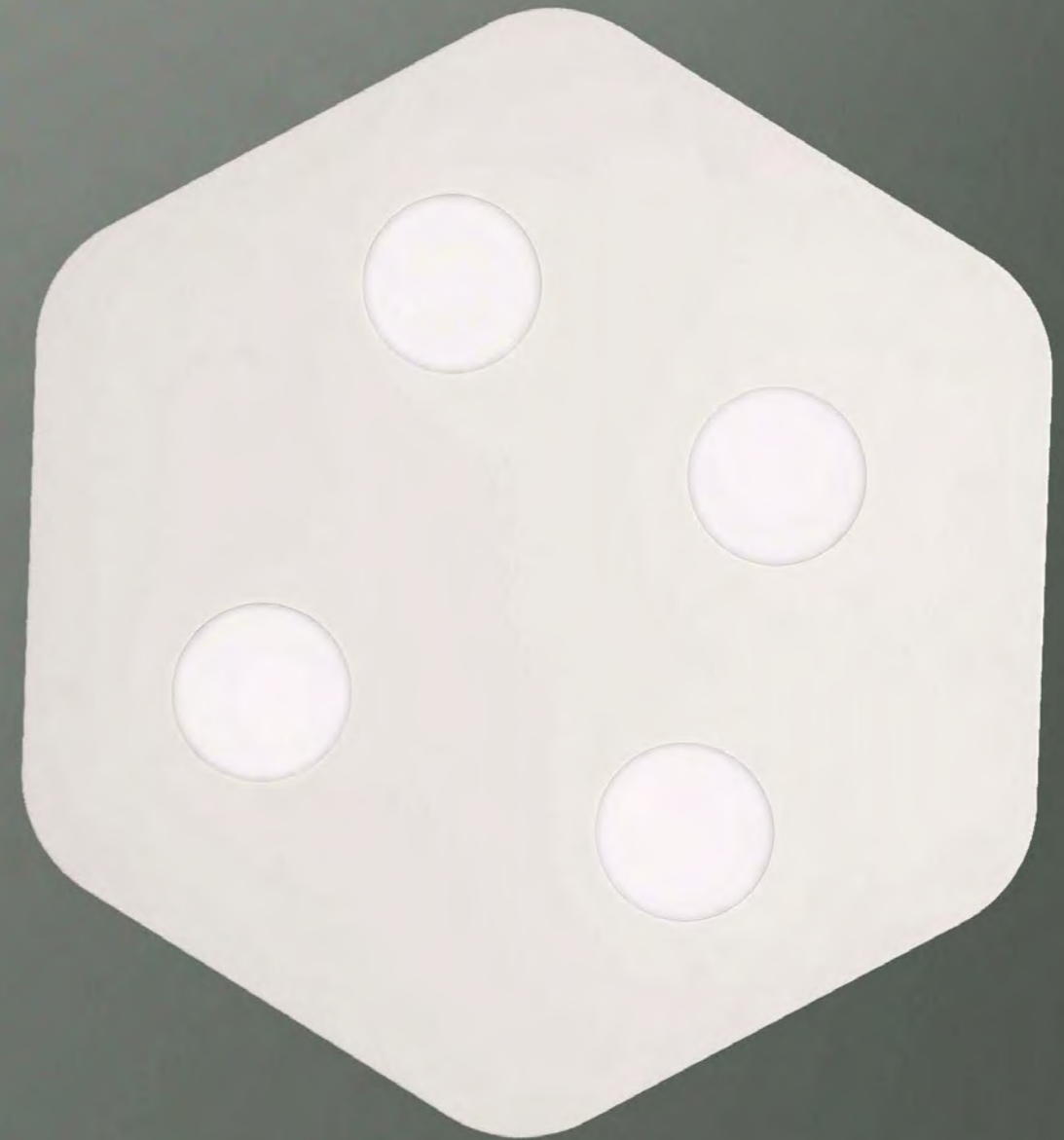

220-240V - 50/60Hz Acero / Acrílico - Steel / Acrylic



**Plafón - Ceiling Lamp**  
Blanco Arena - Sand White

**6643**  
2x GX53 máx.9W/no incl

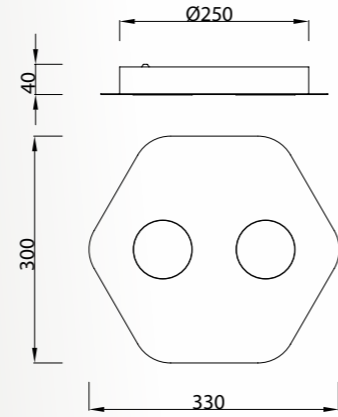

Bombillas Recomendadas  
Suggested Bulbs



**R09224** 3000K  
**R09225** 4000K

**Plafón - Ceiling Lamp**  
Blanco Arena - Sand White

**6644**  
1x GX53 máx.9W/no incl

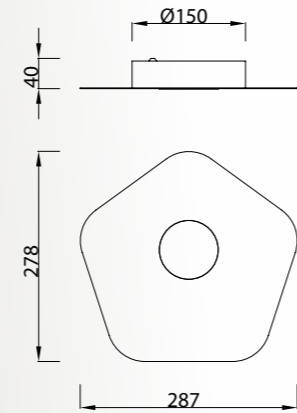

220-240V - 50/60Hz Acero / Acrílico - Steel / Acrylic





## CELESTE

La lámpara Celeste nos evoca las trayectorias de los cuerpos espaciales. Su haz de luz recuerda al recorrido de una esfera celeste que sigue su órbita. Su diseño aéreo y evocador en tres tamaños encajan con todo tipo de ambientes, del más amplio y atrevido al más sencillo y acogedor. Se presenta en dos acabados que se identifican con la división del cielo, un acabado en aluminio lacado blanco representativo de la luz y la versión en lacado negro acorde con la oscuridad. Su construcción semi-esférica de aluminio alberga un difusor de policarbonato el cual permite la propagación de la luz de forma multidireccional, iluminando homogéneamente su entorno.

*The lamp "Celeste" evokes the trajectory of space astros. Its beam of light resembles the path of a celestial sphere on its orbit. Its aerial and evocative three-size design fit perfectly in all type of ambience, from the most daring and widest to the coziest and simplest of them. It is presented in two finishes, which identify with the sky split, a finish in lacquered white aluminium, representative of light and the version in black lacquer, resembling darkness. Its semi-spherical aluminium construction harbors a polycarbonate difusor which enables the spreading of light in a multidirectional way, lighting up the environment homogeneously.*

Santiago Sevillano



6680

Lámpara - Pendant Lamp  
Blanco - White

**6680**  
LED 40W 3000K 2800lm



220-240V- 50/60Hz CRI >80 Aluminio / Hierro - Aluminium / Iron



Lámpara - Pendant Lamp  
Blanco - White

**6681**  
LED 30W 3000K 2100lm

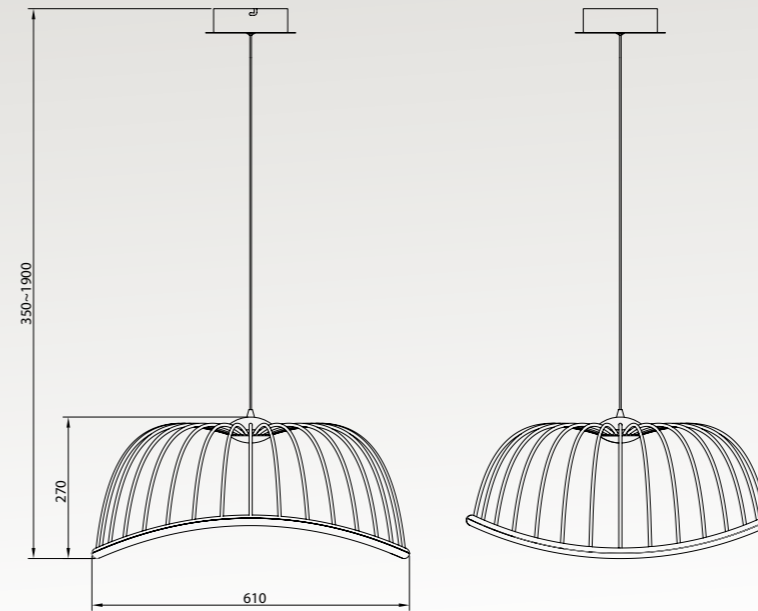

220-240V- 50/60Hz CRI >80 Aluminio / Hierro - Aluminium / Iron

Lámpara - Pendant Lamp  
Blanco - White

**6682**  
LED 20W 3000K 1400lm



220-240V- 50/60Hz CRI >80 Aluminio / Hierro - Aluminium / Iron







Lámpara - Pendant Lamp  
Negro - Black

**6683**  
LED 40W 3000K 2800lm

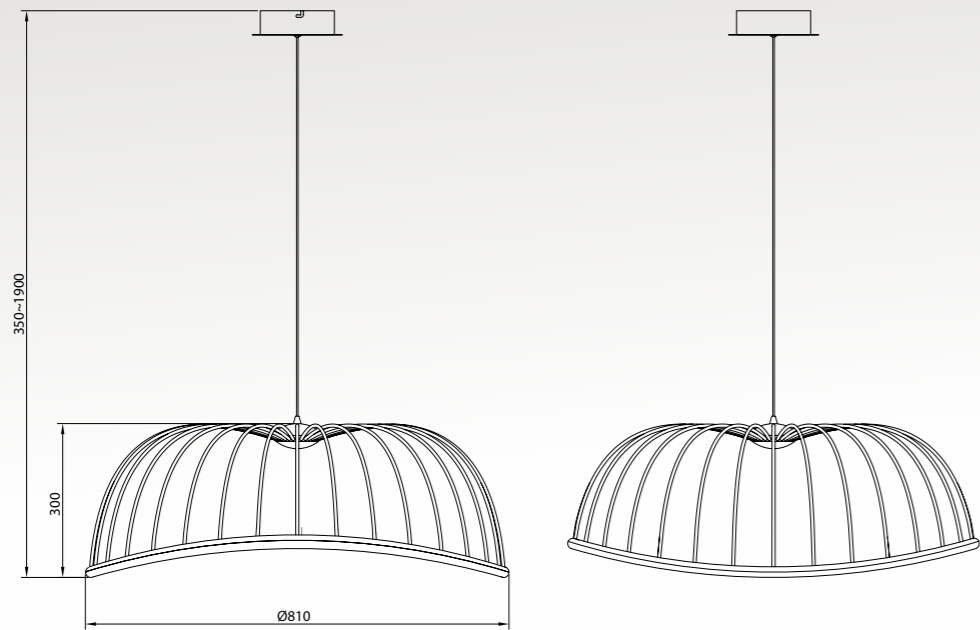

220-240V- 50/60Hz CRI >80 Aluminio / Hierro - Aluminium / Iron



Lámpara - Pendant Lamp  
Negro - Black

**6684**  
LED 30W 3000K 2100lm

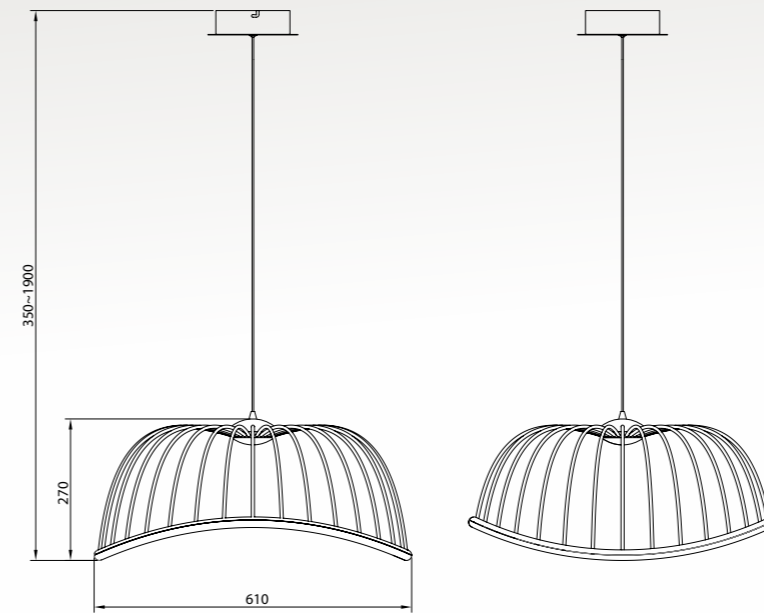

Lámpara - Pendant Lamp  
Negro - Black

**6685**  
LED 20W 3000K 1400lm



220-240V- 50/60Hz CRI >80 Aluminio / Hierro - Aluminium / Iron



## MURAL

Mantra presenta esta colección de iluminación led, para vestir espacios de manera integral con la superposición compositiva de sus formas geométricas; Estas generan un juego de efectos luminosos que aportan un toque especial en sus diferentes combinaciones posibles por sus estructuras y su luz tanto a techo, pared o como estéticos auxiliares.

Líneas mínimas vestidas de blanco están surcadas por estrechos trazados de led, que aportan una ambientación por contraluz, generando estéticos dibujos sobre las superficies, y a su vez efectivos con sus potentes puntos de luz dirigidos a los espacios. Cruces de ángulos y círculos diseñan sus versiones de apliques y plafones en distintas dimensiones, también estructuras rectangulares en sus modelos de semi-plafón, sobremesa y pie de salón componiendo la colección

MURAL; Elementos minimalistas y estéticos que darán vida y ambiente a tu estancia favorita.

*Mantra presents this collection of LED lighting to fully dress up spaces with the compositive superposition of its geometric shapes; these generate a game of lighting effects that contribute with a special touch through its different possible combinations by means of its structures and lights on ceilings, walls or as auxiliary items. Minimal white lines scored by thin intertwined Leds that produce an atmosphere out of backlight, generating aesthetic drawings on surfaces, through its powerful lighting points, when focusing upon them. Angle and circle crossings design its versions of appliques and plafonniers in different sizes and rectangular structures in its models of semi-plaffonier, table lamp and floor lamp, making up this special collection, MURAL: in short, minimalistic and aesthetic elements that will enrich and liven up your favourite living space.*

Mantra Team

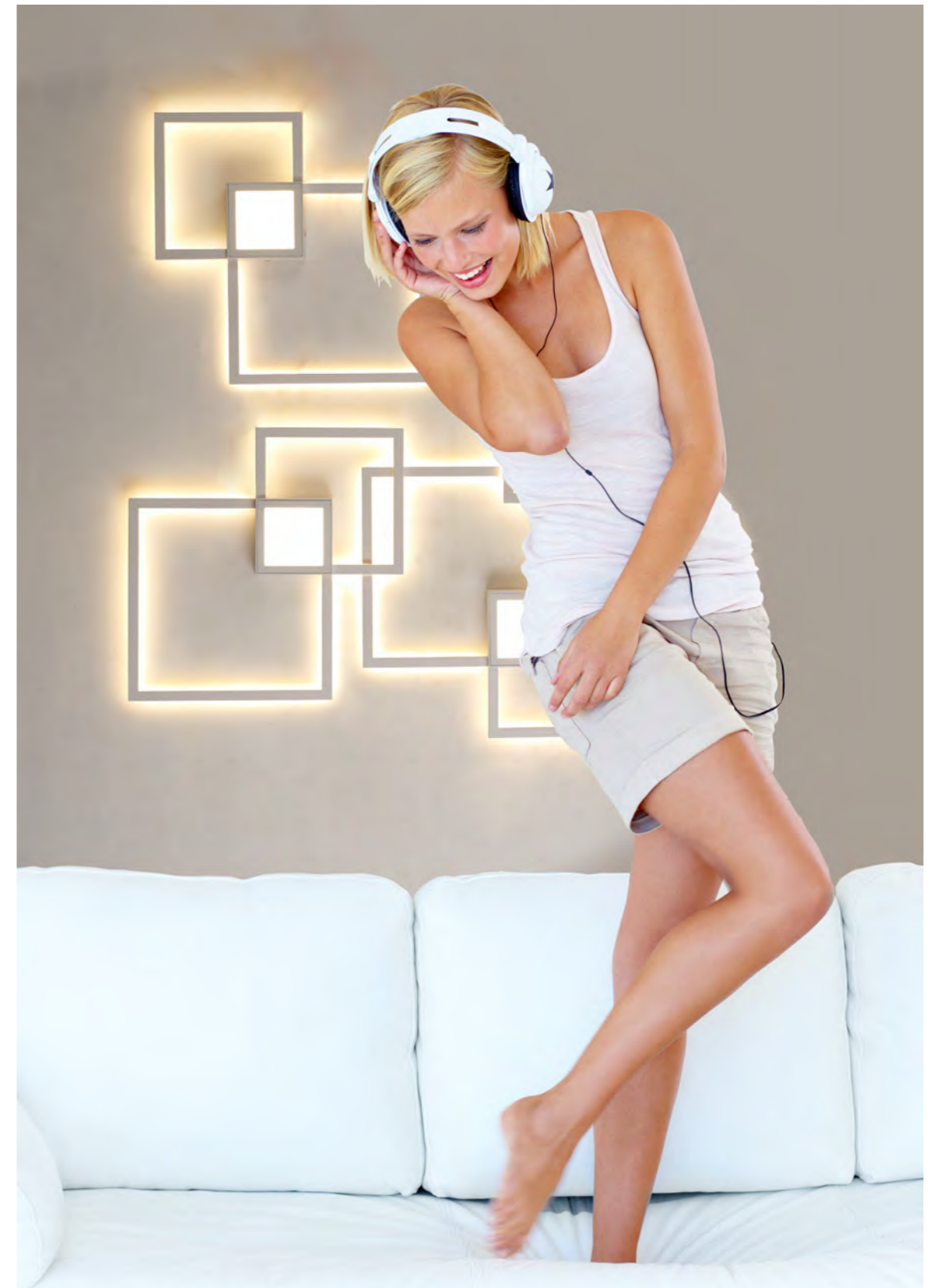



# Mura

**Plafón/Aplique - Ceiling Lamp/Wall Lamp**  
Blanco mate - White Matt

**6564**  
LED 48W 3000K 3600 lm

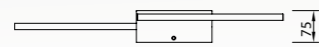
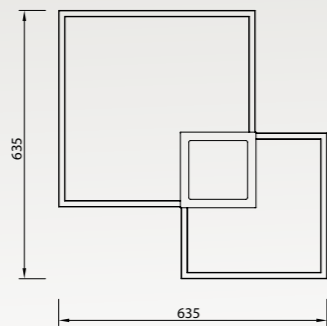
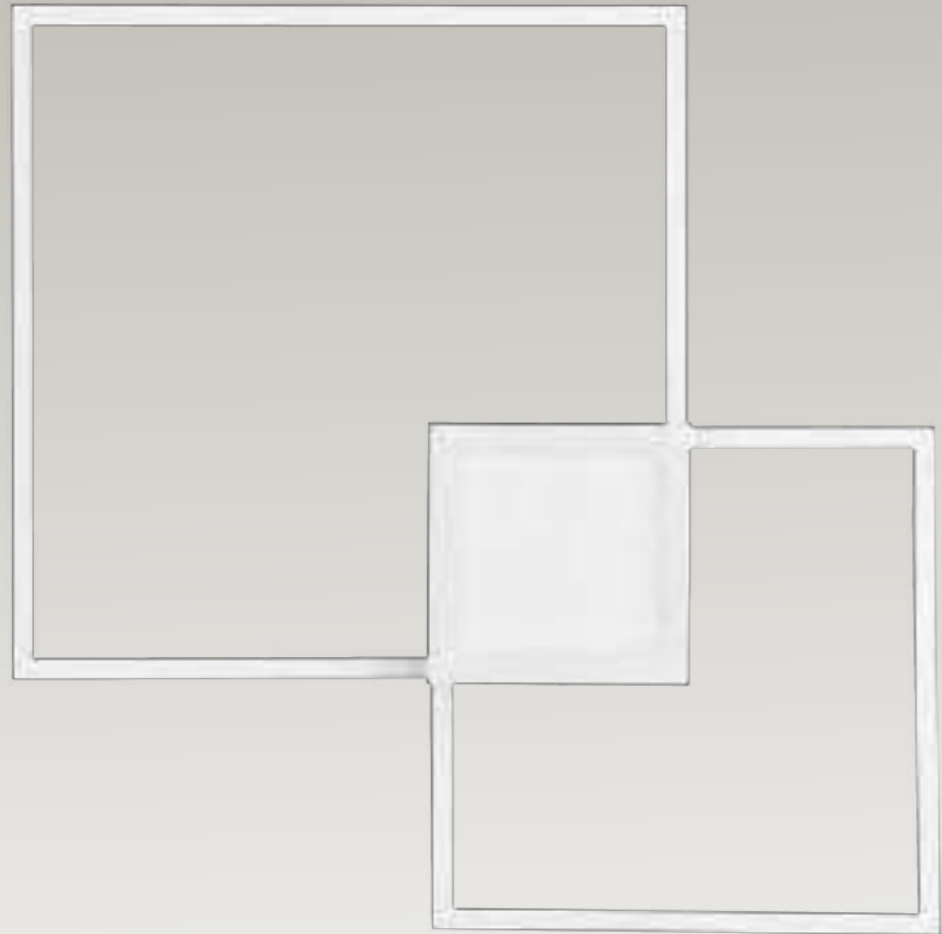

**Plafón/Aplique - Ceiling Lamp/Wall Lamp**  
Blanco mate - White Matt

**6565**  
LED 48W 3000K 3600 lm  
Dimmable



220-240V-50/60Hz CRI>80 Aluminio - Aluminium

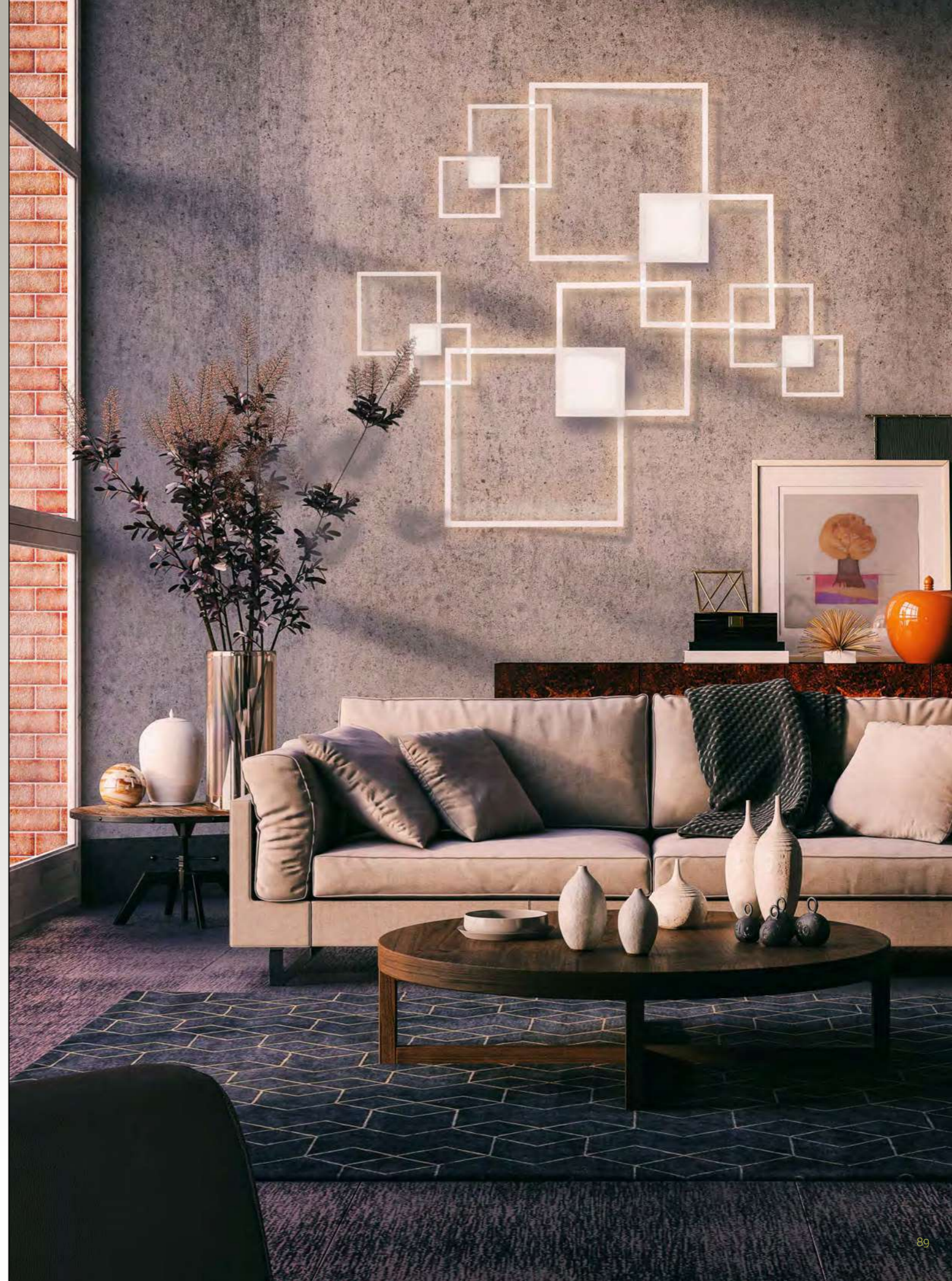



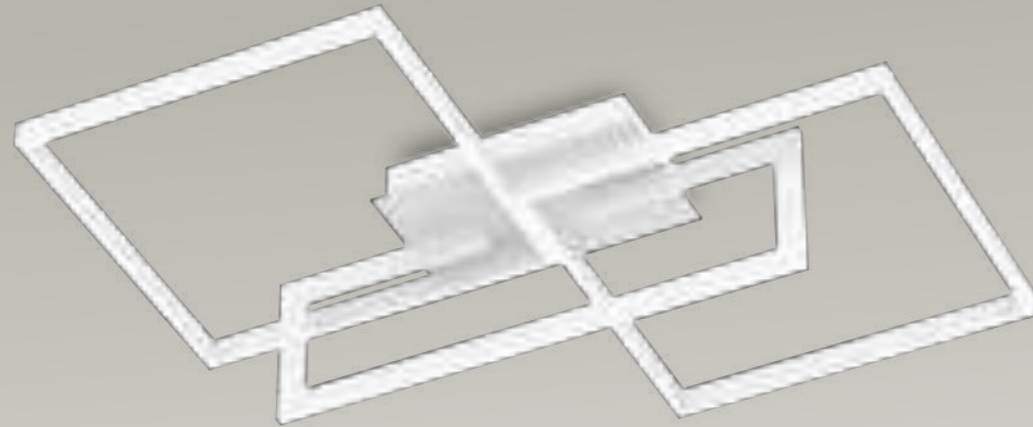

**Plafón - Ceiling lamp**  
Blanco mate - White Matt

**6560**  
LED 48W 3000K 3840 lm

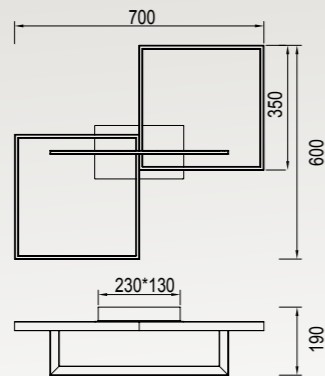

**Plafón - Ceiling lamp**  
Blanco mate - White Matt

**6561**  
LED 48W 3000K 3840 lm



220-240V~50/60Hz CRI>80 Aluminio - Aluminium





# Mural

**Aplique - Wall lamp**  
Blanco mate - White Matt

**6231**  
LED 24W 3000K 1440 lm

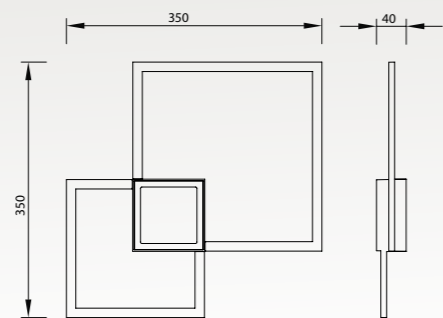
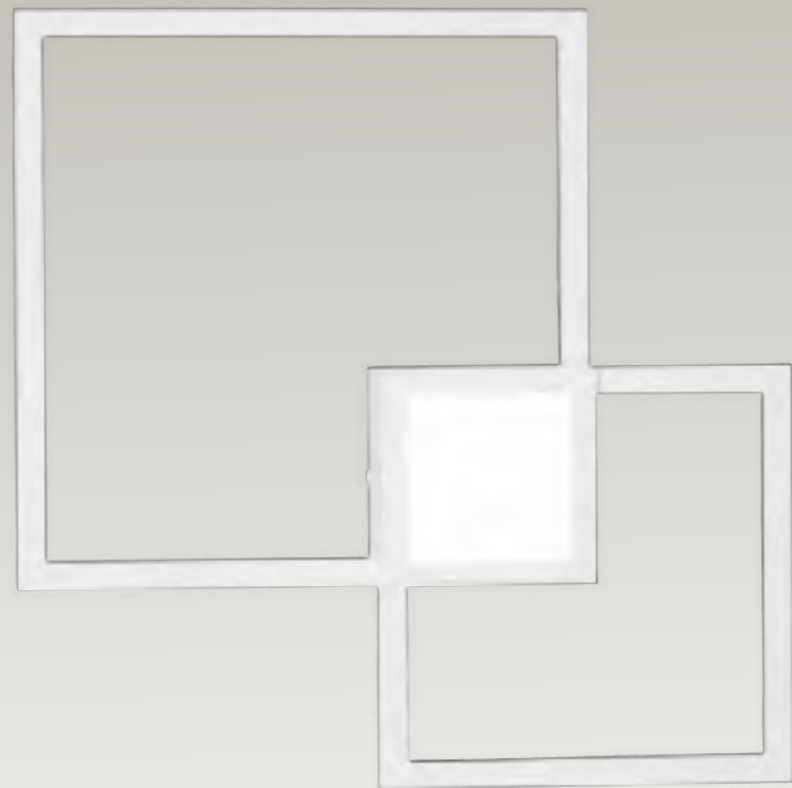

100-250V-50/60Hz CRI>80 Aluminio - Aluminium

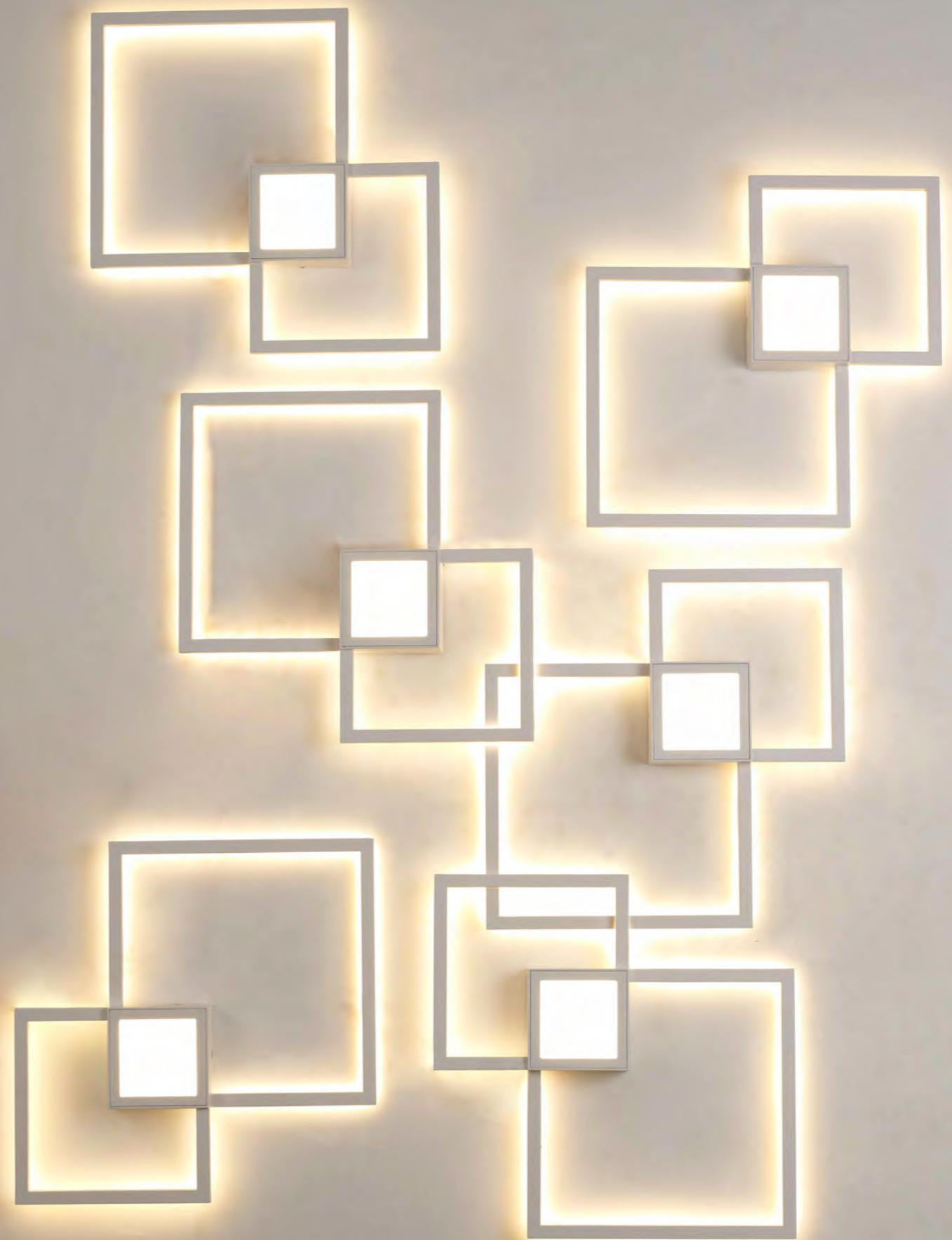



# Mural

**Aplique - Wall lamp**  
Blanco mate - White Matt

**6230**  
LED 24W 3000K 1440 lm

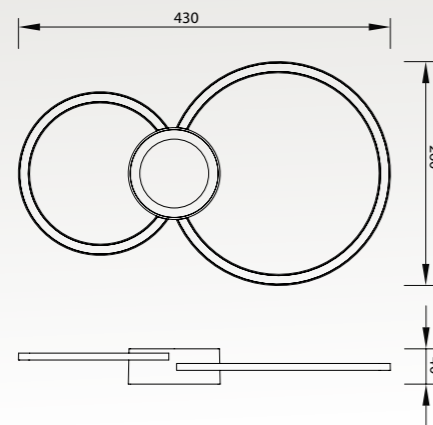
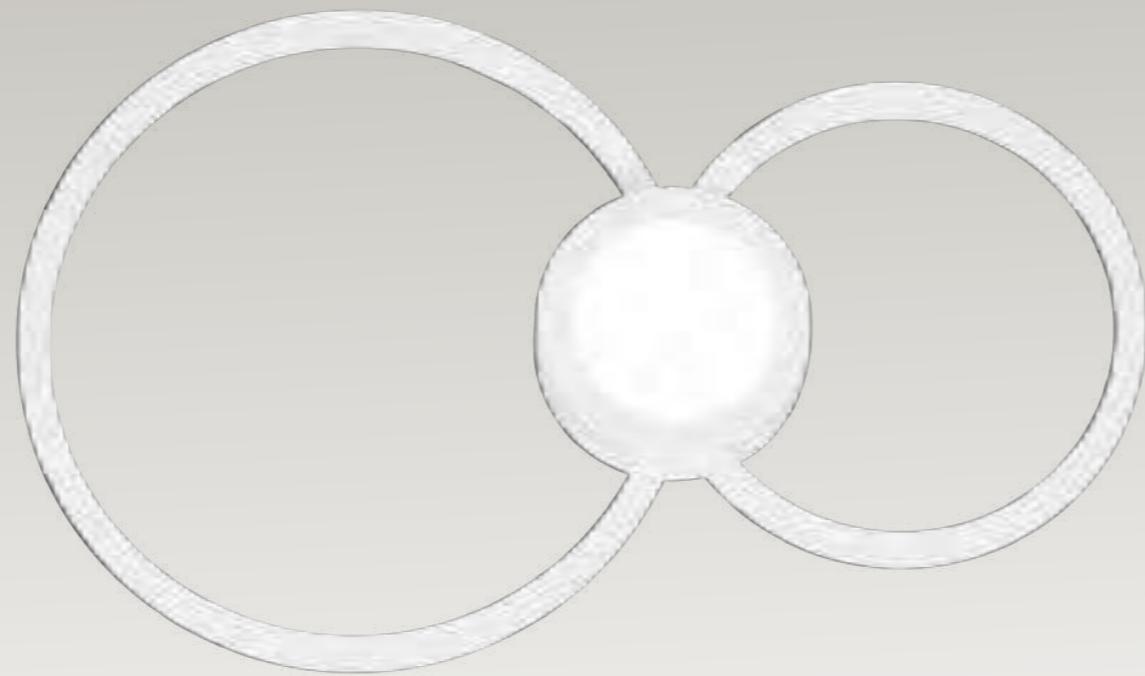

100-250V-50/60Hz CRI>80 Aluminio - Aluminium





# Mural

**Pie de Salón - Floor lamp**  
Blanco mate - White Matt

**6563**  
LED 48W 3000K 3800 lm  
Dimmable

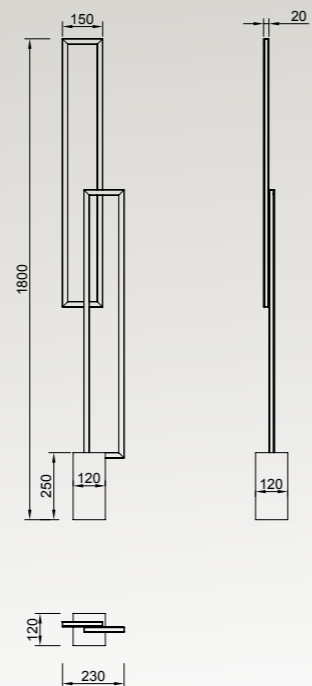

220-240V - 50/60Hz CRI >80 Aluminio / Hierro / Acrílico - Aluminium / Iron / Acrylic





**Sobremesa - Table lamp**  
Blanco mate - White Matt

**6562**  
LED 18W 3000K 1380 lm

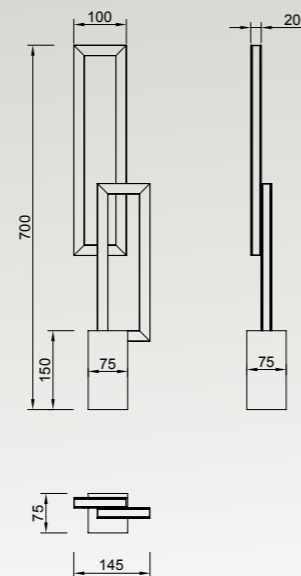
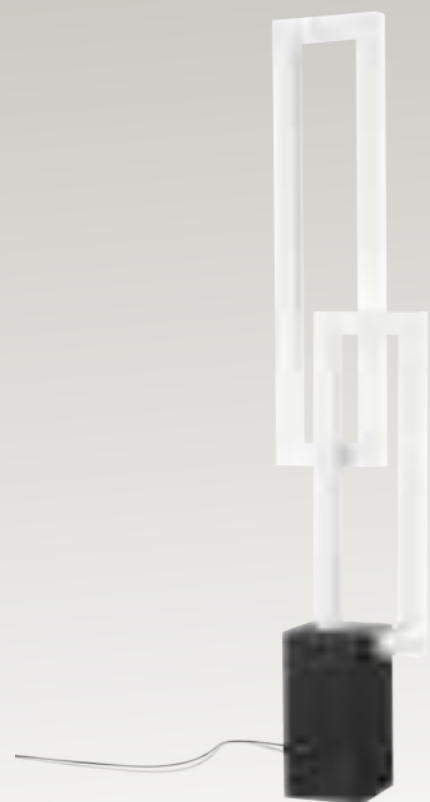

220-240V - 50/60Hz CRI >80 Aluminio / Hierro / Acrílico - Aluminium / Iron / Acrylic



# Olimpia

Olimpia parece flotar en el ambiente; casi sin apoyos, se inspira en la fuerza y voluntad de un atleta ejecutando una figura casi imposible. Nace de la admiración a la esencialidad de la forma, a la perfección, que en geometría viene representada por la circunferencia. La distribución equilibrada y uniforme de la luz genera una hipnosis visual que se acentúa cuando se encuentra en una composición lumínica múltiple.

*Olimpia seems to float in the environment; barely supported, it is inspired by the strength and will of an athlete executing an almost impossible figure. It is born from the admiration for the essence of form, the perfection, which in geometry is represented by the circumference. The balanced and uniform distribution of light generates a visual hypnosis that is accentuated when it is displayed in a multiple light composition.*

Santiago Sevillano

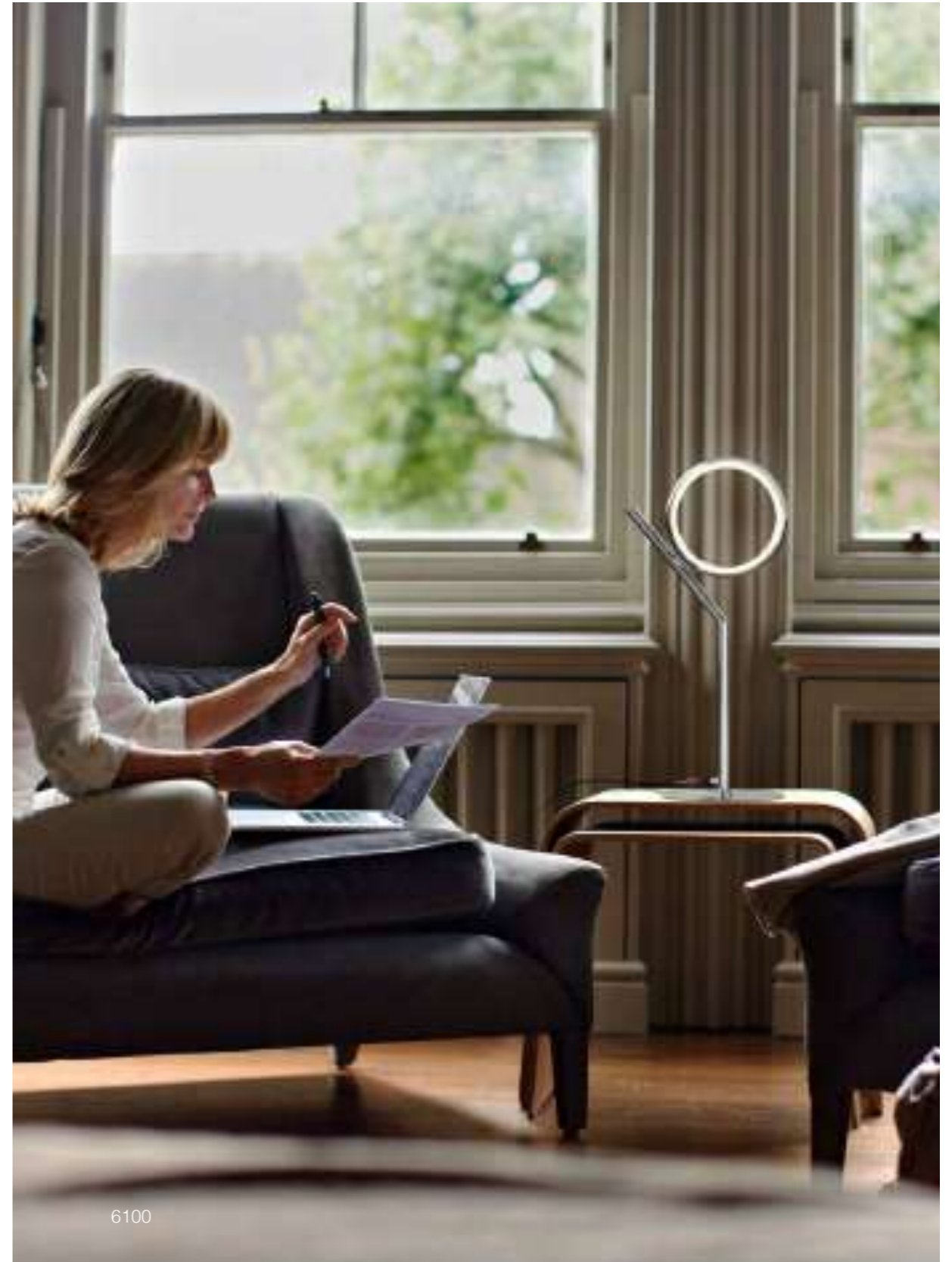

6100

OAMI-006317376-0005-0006-0007-0008



**Pie de Salón - Floor lamp**  
Cromo - Chrome

**6597**  
LED 12W 3000K 900 lm



**Pie de Salón - Floor lamp**  
Oro Satinado - Satin Gold

**6587**  
LED 12W 3000K 900 lm

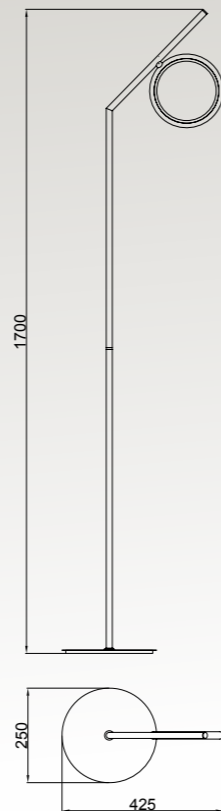

**Sobremesa - Table Lamp**  
Cromo - Chrome

**6596**  
LED 8W 3000K 600 lm



**Sobremesa - Table Lamp**  
Oro Satinado - Satin Gold

**6586**  
LED 8W 3000K 600 lm

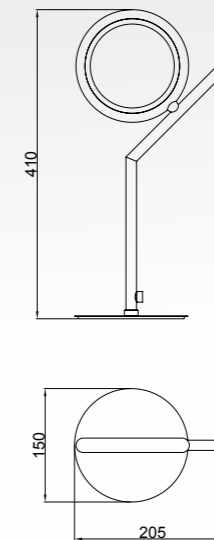

100-240V~50/60Hz CRI >80 Aluminio /silicona / acero- Aluminium /silicone /Steel



100-240V~50/60Hz CRI >80 Aluminio /silicona / acero- Aluminium /silicone /Steel

# Olimpia

Plafón - Ceiling Lamp  
Oro Satinado - Satin Gold

6580  
LED 42W 3000K 3150lm

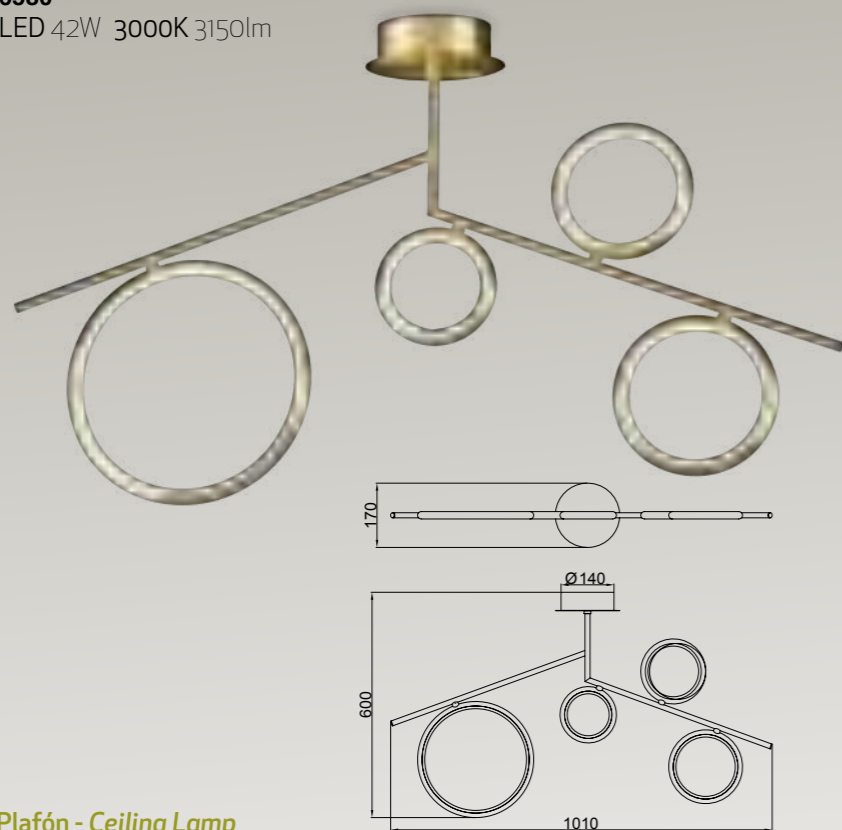

Plafón - Ceiling Lamp  
Cromo - Chrome

6590  
LED 42W 3000K 3150lm



100-240V~50/60Hz CRI>80 Aluminio / silicona / acero - Aluminium / silicone / Steel







Plafón - Ceiling Lamp  
Oro Satinado - Satin Gold

6581  
LED 36W 3000K 2700 lm

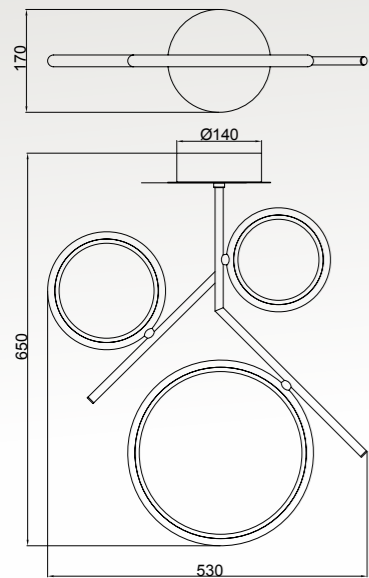

220-240V~50/60Hz CRI >80 Aluminio /silicona / acero- Aluminium /silicone / Steel



Plafón - Ceiling Lamp  
Cromo - Chrome

6591  
LED 36W 3000K 2700 lm

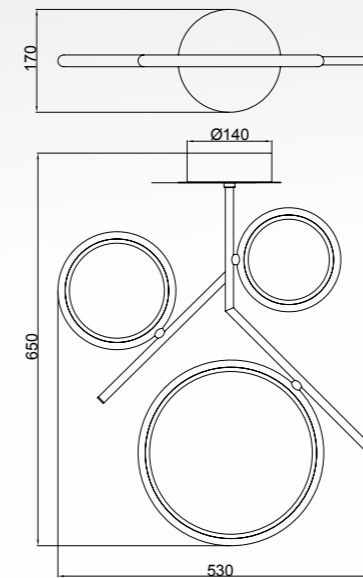

220-240V~50/60Hz CRI >80 Aluminio /silicona / acero- Aluminium /silicone / Steel





Plafón - Ceiling Lamp  
Oro Satinado - Satin Gold

6582  
LED 30W 3000K 2250 lm

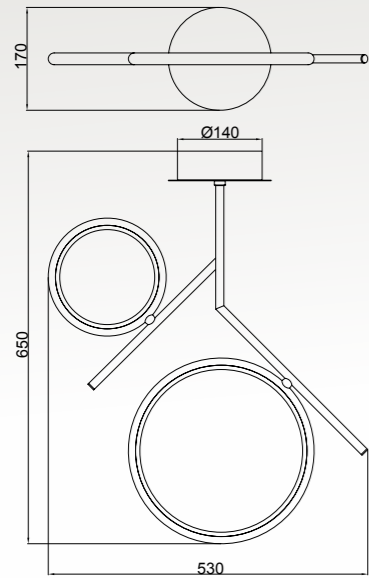

220-240V~ 50/60Hz CRI>80 Aluminio / silicona / acero- Aluminium / silicone / Steel



Plafón - Ceiling Lamp  
Cromo - Chrome

6592  
LED 30W 3000K 2250 lm

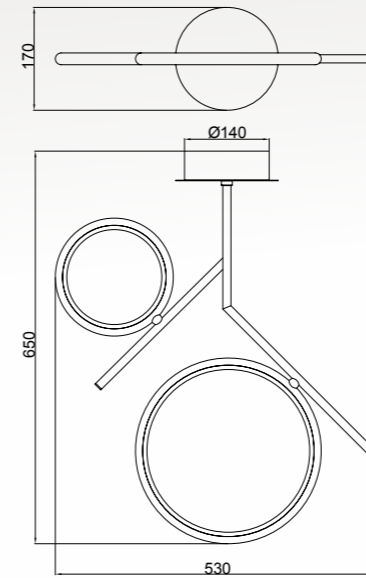

220-240V~ 50/60Hz CRI>80 Aluminio / silicona / acero- Aluminium / silicone / Steel





6595 - 6592



**Plafón - Ceiling Lamp**  
Oro Satinado - Satin Gold

**6584**  
LED 20W 3000K 1500 lm

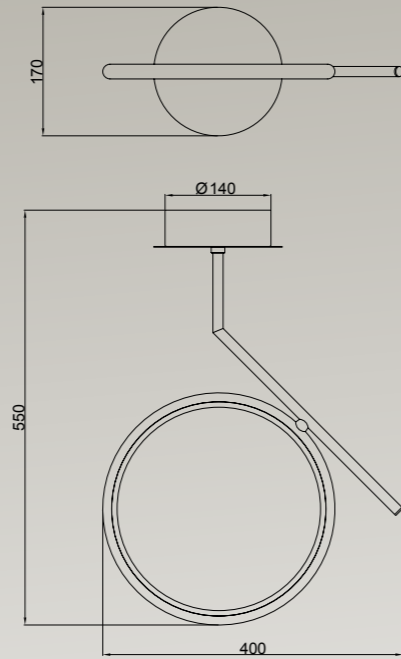

**Plafón - Ceiling Lamp**  
Oro Satinado - Satin Gold

**6583**  
LED 25W 3000K 1875 lm

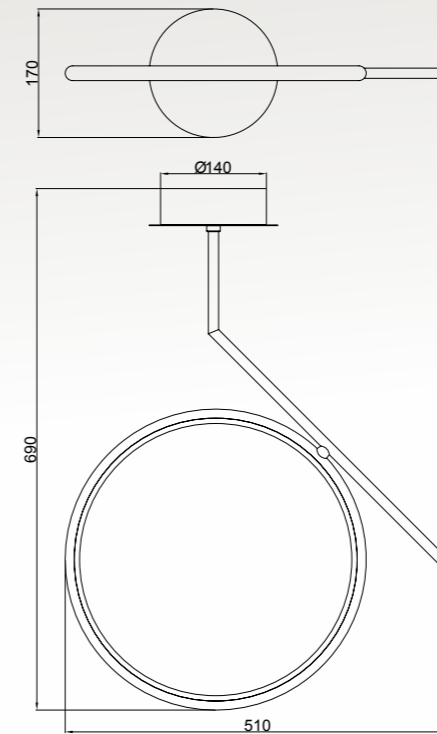

**Aplique - Wall Lamp**  
Oro Satinado - Satin Gold

**6585**  
LED 8W 3000K 600 lm

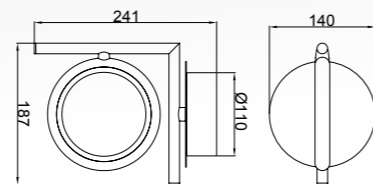
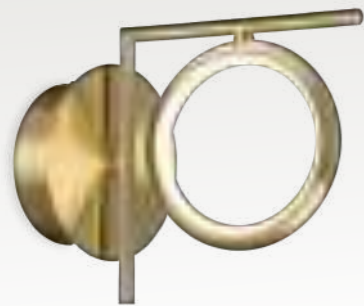

220-240V~ 50/60Hz CRI>80 Aluminio /silicona / acero- Aluminium /silicone / Steel



220-240V~ 50/60Hz CRI>80 Aluminio /silicona / acero- Aluminium /silicone / Steel



**Plafón - Ceiling Lamp**  
Cromo - Chrome

**6594**  
LED 20W 3000K 1500 lm

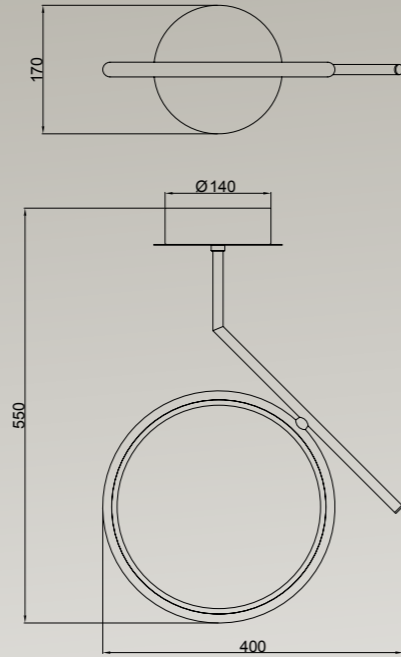

**Aplique - Wall Lamp**  
Cromo - Chrome

**6595**  
LED 8W 3000K 600 lm

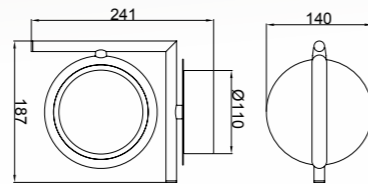

**Plafón - Ceiling Lamp**  
Cromo - Chrome

**6593**  
LED 25W 3000K 1875 lm

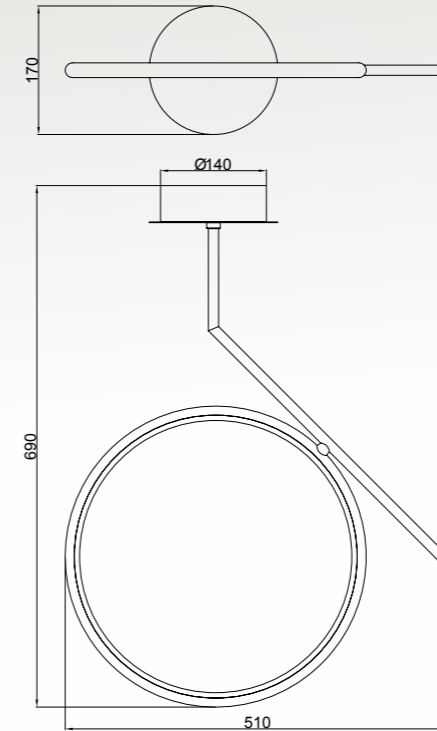

220-240V~ 50/60Hz CRI>80 Aluminio /silicona / acero- Aluminium/silicone/ Steel



220-240V~ 50/60Hz CRI>80 Aluminio /silicona / acero- Aluminium/silicone/ Steel





# Madagascar

La colección MADAGASCAR propone una manera distinta de vestir su fuente de luz LED. Pues mediante giros helicoidales (hasta ahora constructivamente imposibles) reparte equitativamente su luz al espacio, a la vez que plantea originales formas en sus estructuras. Con base acrílica, para recibir la tira led, presenta un difusor dúctil de neopreno traslúcido, que va adaptándose sobre ella y difunde la luz en figuras que van girando sobre su propio eje. De manera que la colección MADAGASCAR la componen colgantes circulares en tres formatos, una lámpara lineal, así como un sobremesa y un estilizado pie de salón para dar un toque distintivo a su espacio elegido.

*The MAGADASCAR collection proposes a novel way to embellish its LED lighting source, by using helicoidal twists (of imposible production so far), which equally spread the light into space, providing innovative shapes in its structures. With an acrylic base embracing the LED strip, it offers an adaptable ductile difusor of translucent neoprene, which grows adapting over it and diffuses the light in shapes that twist over its own axis. MAGADASCAR collection consists of three formats of circular pendant, linear lamp, table lamp and an stylish floor lamp to give a distinctive touch to any chosen space.*

Equipo Mantra

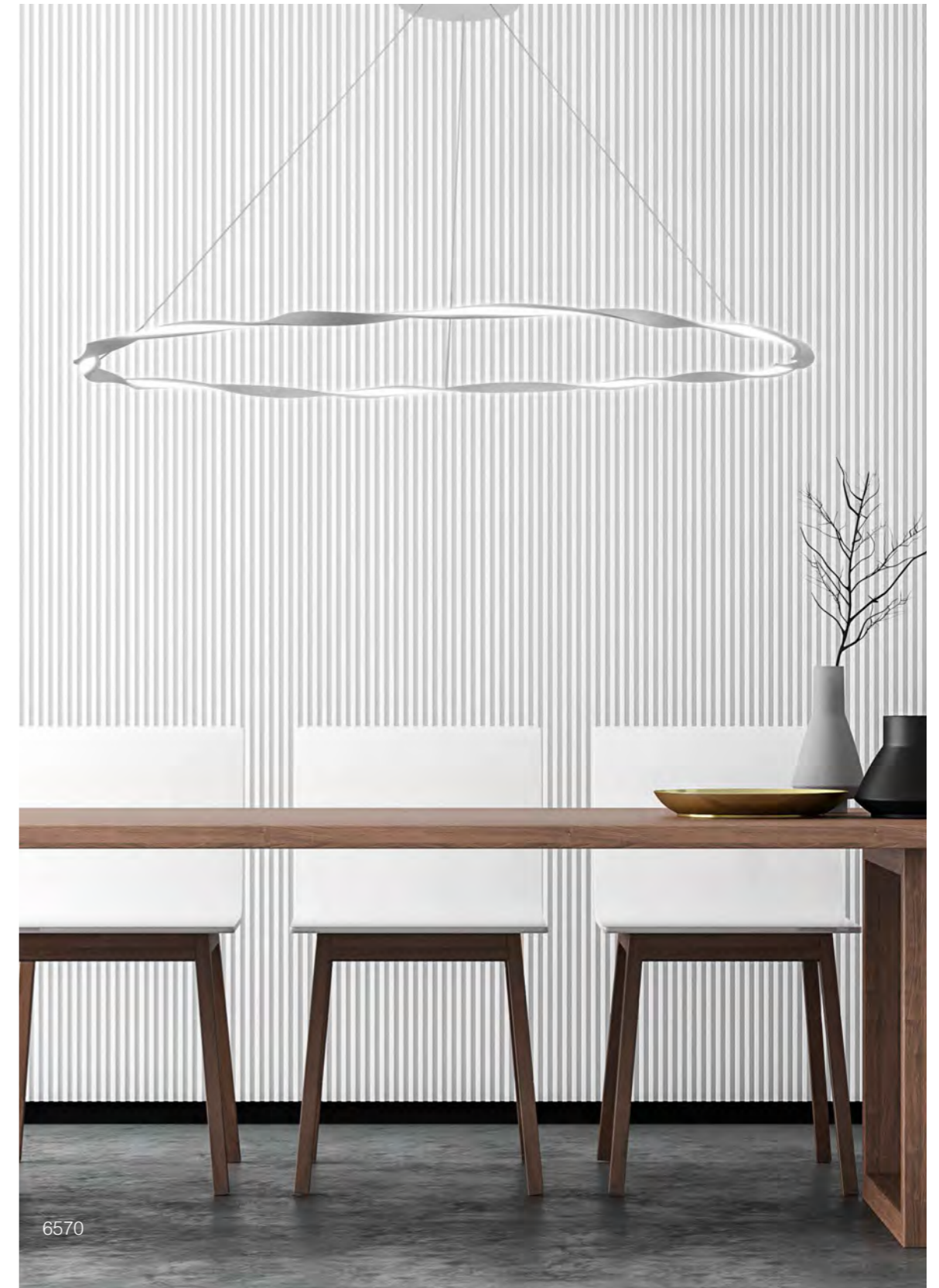

6570

OAMI 006317376-0001-0002-0003-0004

Lámpara - Pendant Lamp  
Blanco Arena - Sand White

6573  
LED 24W 3000K 1680 lm

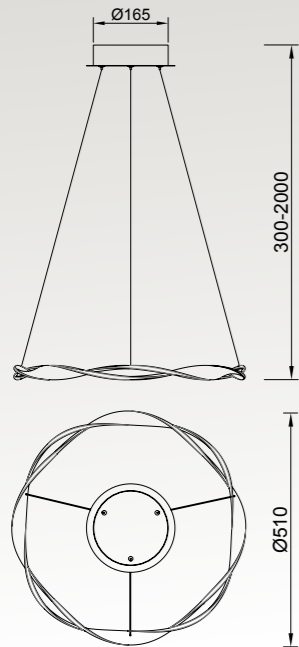
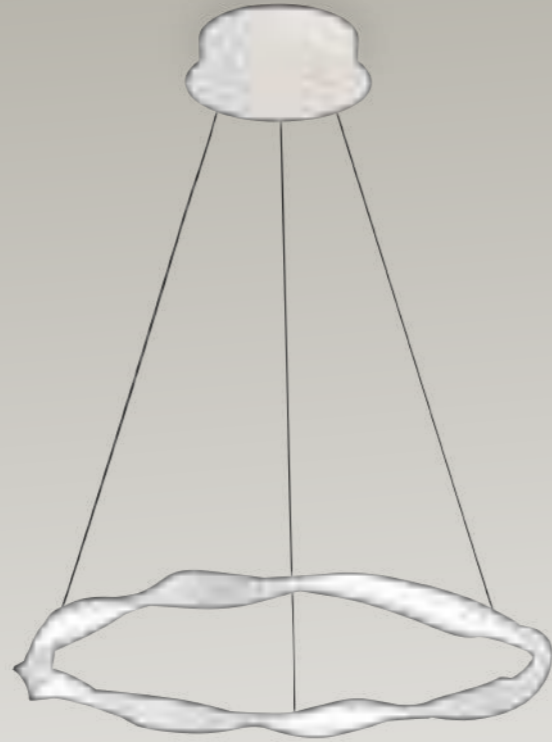

Lámpara - Pendant Lamp  
Blanco Arena - Sand White

6571  
LED 36W 3000K 2520 lm

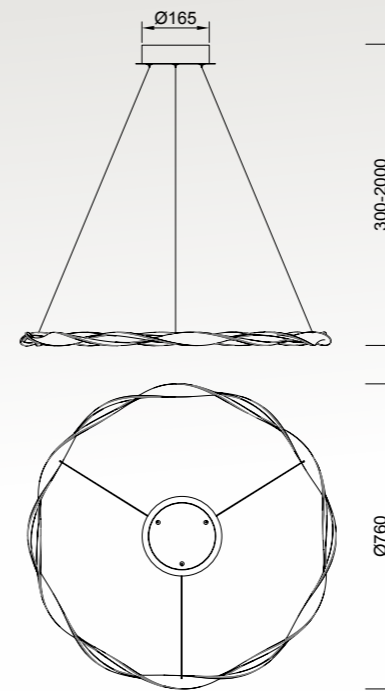

220-240V~50/60Hz CRI>80 Aluminio / Silicona - Aluminium / Silicone



220-240V~50/60Hz CRI>80 Aluminio / Silicona - Aluminium / Silicone





Lámpara - Pendant Lamp  
Blanco Arena - Sand White

6570  
LED 46W 3000K 3220 lm

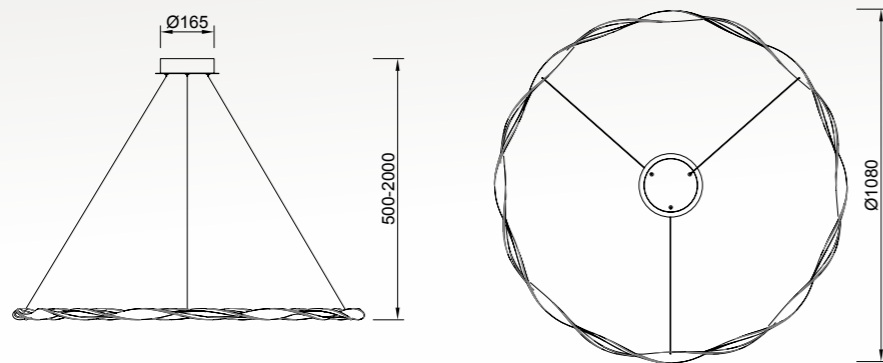

220-240V-50/60Hz CRI >80 Aluminio / Silicona - Aluminium / Silicone









**Lámpara - Pendant Lamp**  
Blanco Arena - Sand White

**6572**  
LED 33W 3000K 2310 lm

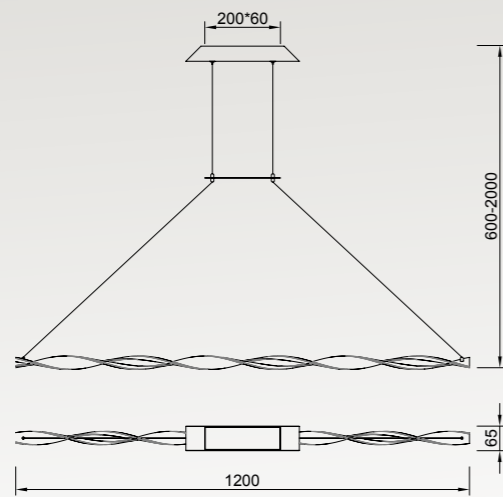
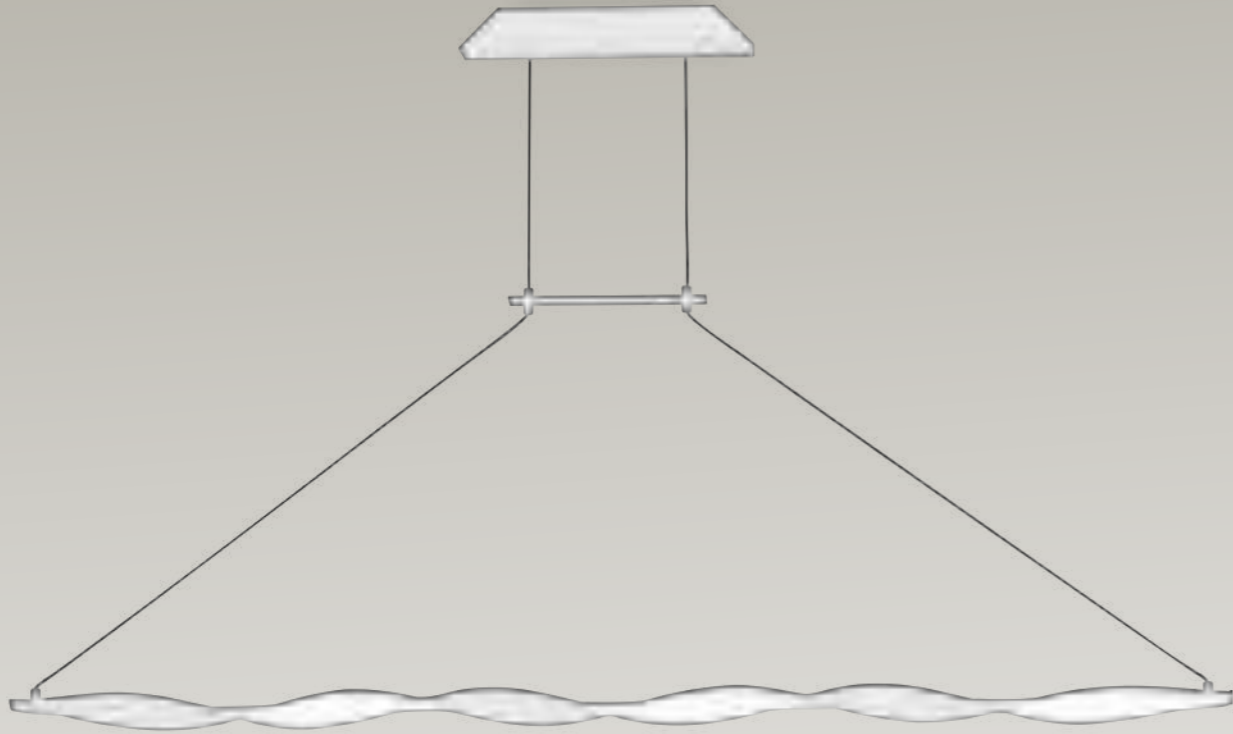

220-240V~ 50/60Hz CRI>80 Aluminio / Silicona - Aluminium / Silicone



**Sobremesa - Table Lamp**  
Blanco Arena - Sand White

**6574**  
LED 9W 3000K 630 lm

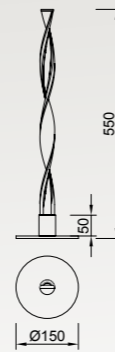

**Pie De Salón - Floor Lamp**  
Blanco Arena - Sand White

**6575**  
LED 24W 3000K 1680 lm



220-240V~ 50/60Hz CRI>80 Aluminio / Silicona - Aluminium / Silicone







# Tsunami

TSUNAMI es una original colección de iluminación led, donde su diseño nos plantea una presentación diferente de su fuente de luz; Mediante giros y movimientos sobre planos helicoidales definidos se consiguen armoniosas formas que van en combinación concretando cada uno de los elementos que la componen, en cuatro giros su lámpara lineal y plafón cuadrado, de tres en su estilizado pie de salón, y en dos y una para sus auxiliares de pared y sobremesa, cerrando una colección de potentes lúmens con temperatura de color cálida de 3000k.

*TSUNAMI is an original collection of led lights, whose design offers a new perspective in its light source; Creative twists and movements over helicoidal plans lead to armonious shapes which result in a perfect combination of its parts, ending up in a set of four twists for the lineal lamp and square plafonnier, , three twists for its stylish floor lamp and two or one in its auxiliary wall and table lamps, becoming a powerful lumens collection with warm colour light of 3000 k.*

Mantra Team

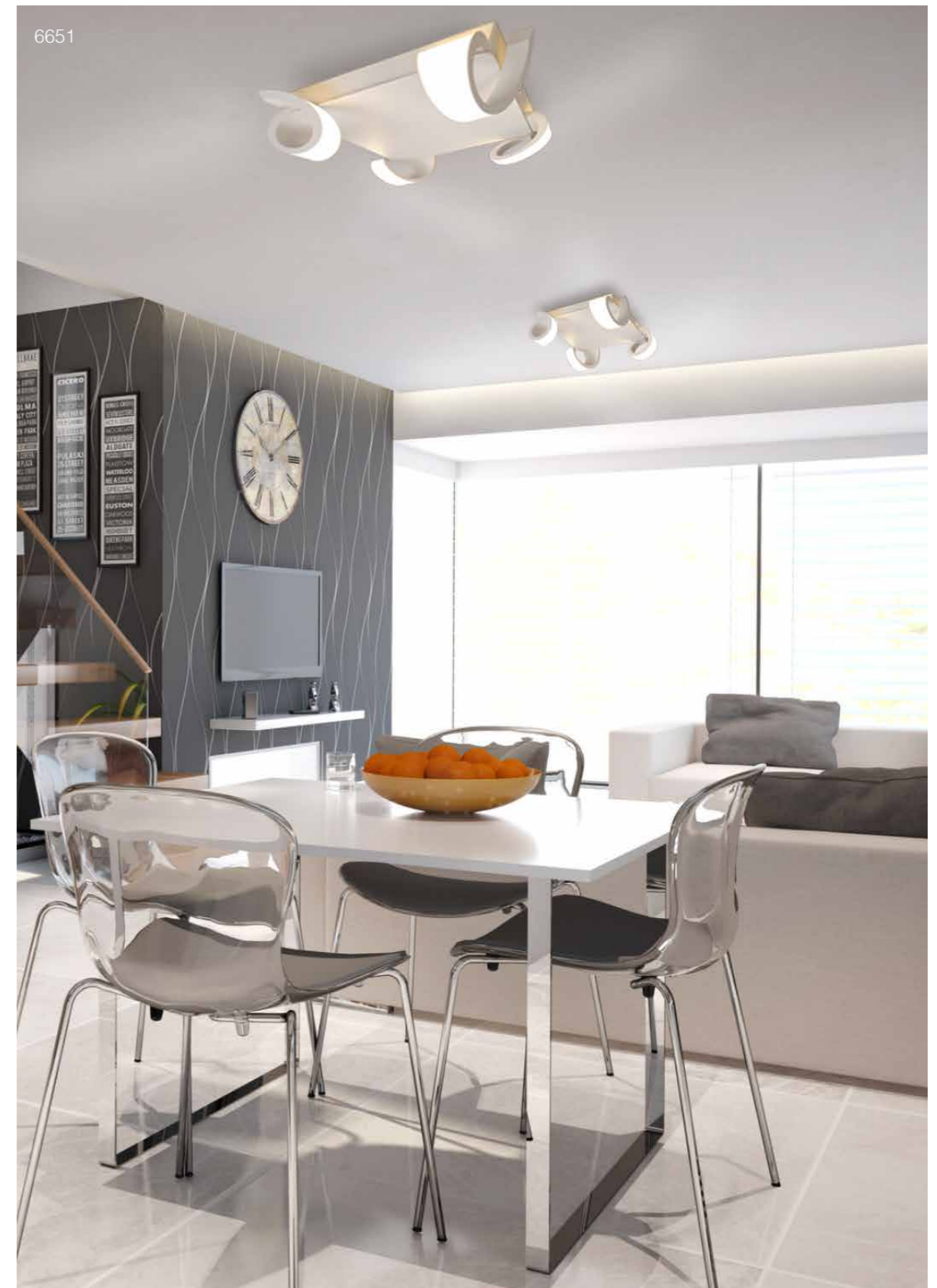

6651

**Aplique - Wall Lamp**  
Blanco Arena - Sand White

**6652**  
LED 24W 3000K 1800 lm

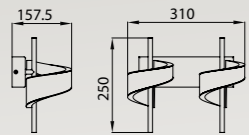
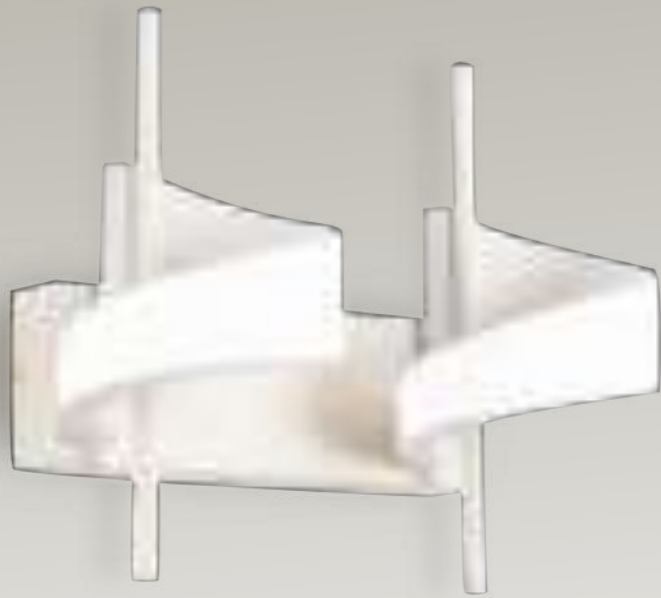

**Aplique - Wall Lamp**  
Blanco Arena - Sand White

**6653**  
LED 12W 3000K 900 lm

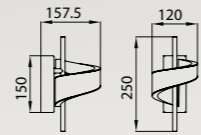

**Plafón - Ceiling Lamp**  
Blanco Arena - Sand White

**6651**  
LED 48W 3000K 3600 lm

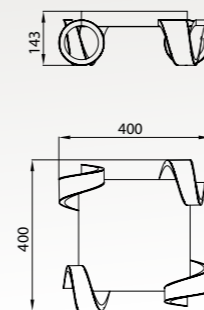

**Aplique - Wall Lamp**  
Blanco Arena - Sand White

**6654**  
LED 12W 3000K 900 lm

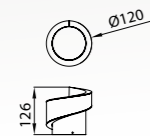





**Lámpara - Pendant Lamp**  
Blanco Arena - Sand White

**6650**  
LED 48W 3000K 3600 lm

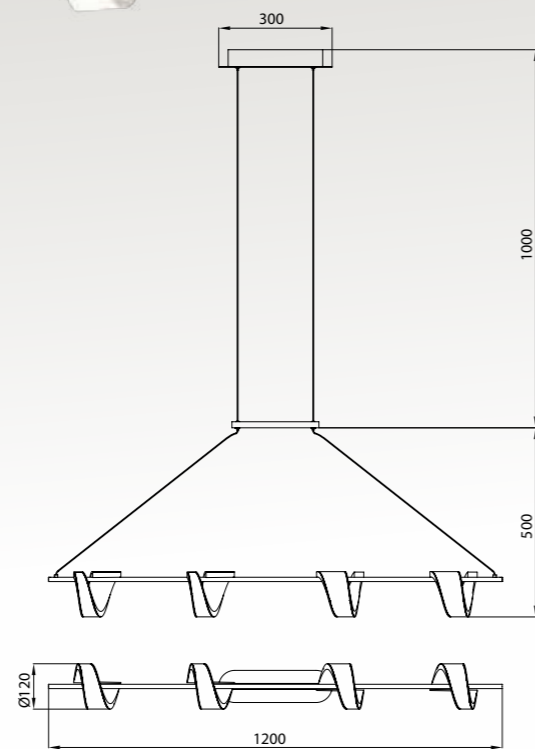
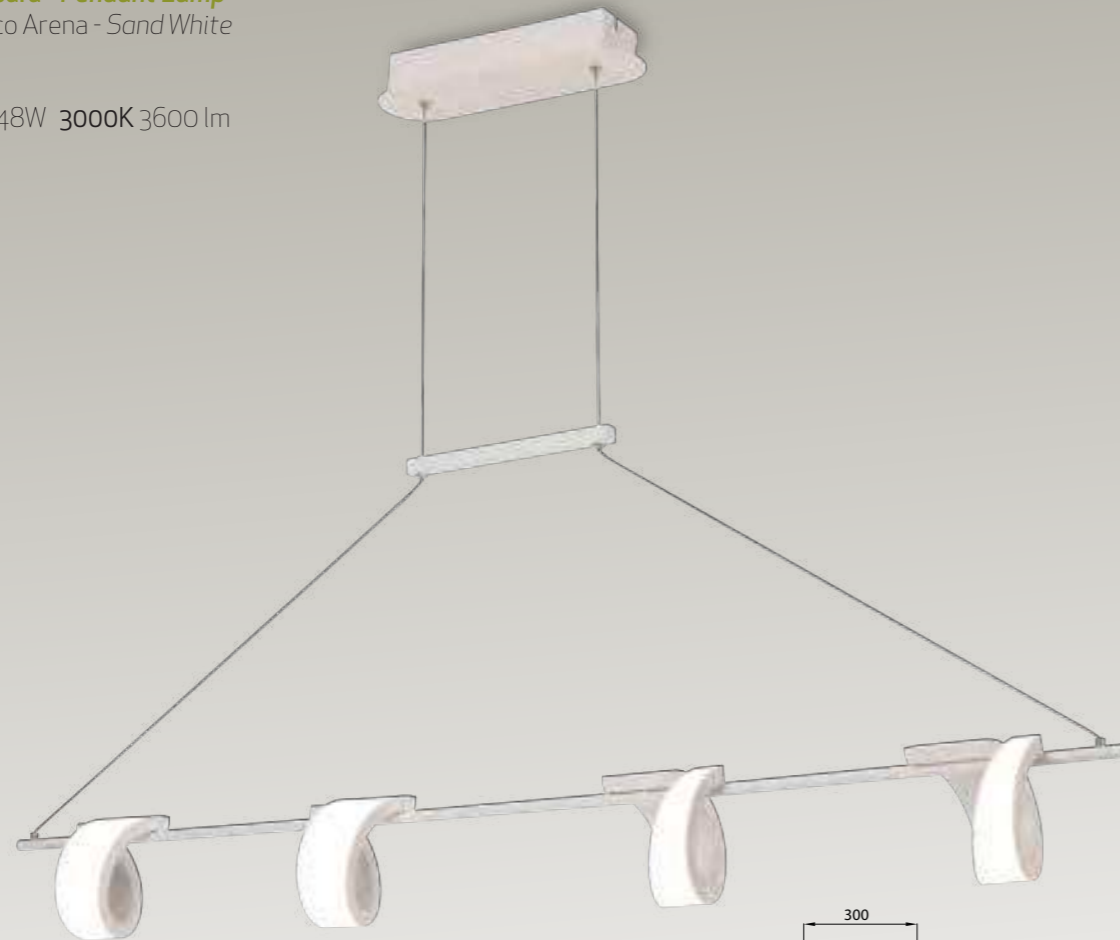

**Sobremesa - Table Lamp**  
Blanco Arena - Sand White

**6655**  
LED 6W 3000K 450 lm

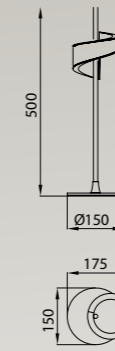

**Sobremesa - Table Lamp**  
Blanco Arena - Sand White

**6656**  
LED 12W 3000K 900 lm

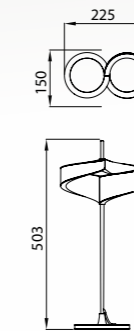

**Pie De Salón - Floor Lamp**  
Blanco Arena - Sand White

**6657**  
LED 36W 3000K 2700 lm

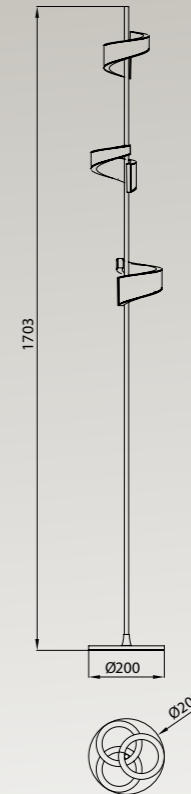

AC220-240V 50-60Hz CRI>80 Aluminio / Hierro / Acrílico - Aluminium / Iron / Acrylic



100-240V 50-60Hz CRI>80 Aluminio / Hierro / Acrílico - Aluminium / Iron / Acrylic



# Helix

Helix es un pie de salón concebido como una curva que da luz y aire a todo su entorno. Esta proyectada como un objeto escultórico para el hogar dentro de un estilo minimalista.

Helix es la metáfora de un a rama que se quiere retorcer hacia la luz formando una línea helicoidal.

*Helix is a floor lamp designed as a curve that gives off light and air to its surroundings. It is designed as a sculptural object for the home in a minimalistic style.*

*Helix is the metaphor of a branch that twists in search of light forming a helical line.*

Santiago Sevillano



OAMI 004721413-001

**Pie de Salón - Floor lamp**  
Plata Cromo - Silver Chrome  
Dimable - Dimmable

**6100**  
LED 42W 3000K 3360 lm



**Pie de Salón - Floor lamp**  
Blanco Crome - White Chrome  
Dimable - Dimmable

**6102**  
LED 42W 4000K 3360 lm



**Pie de Salón - Floor lamp**  
Cuero Satinado - Satin antique  
Dimable - Dimmable

**6101**  
LED 42W 3000K 3360 lm

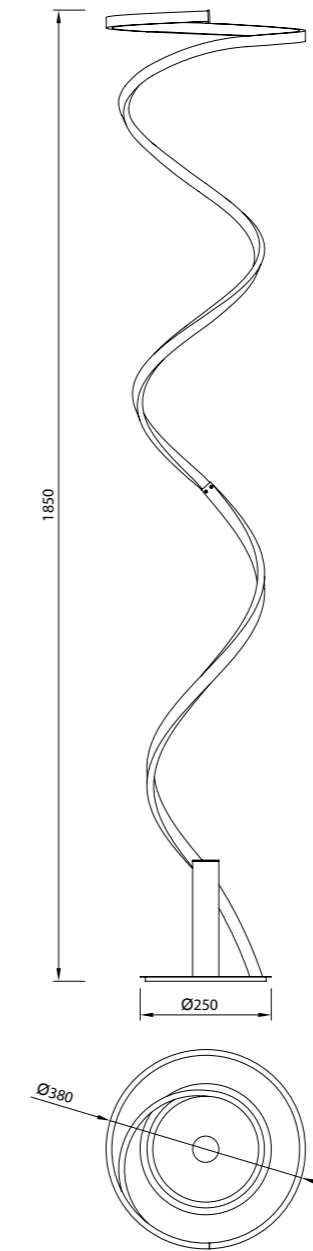

220-240V- 50/60Hz CRI>80 Aluminio / Acero / Acrílico - Aluminum / Steel / Acrylic



6106

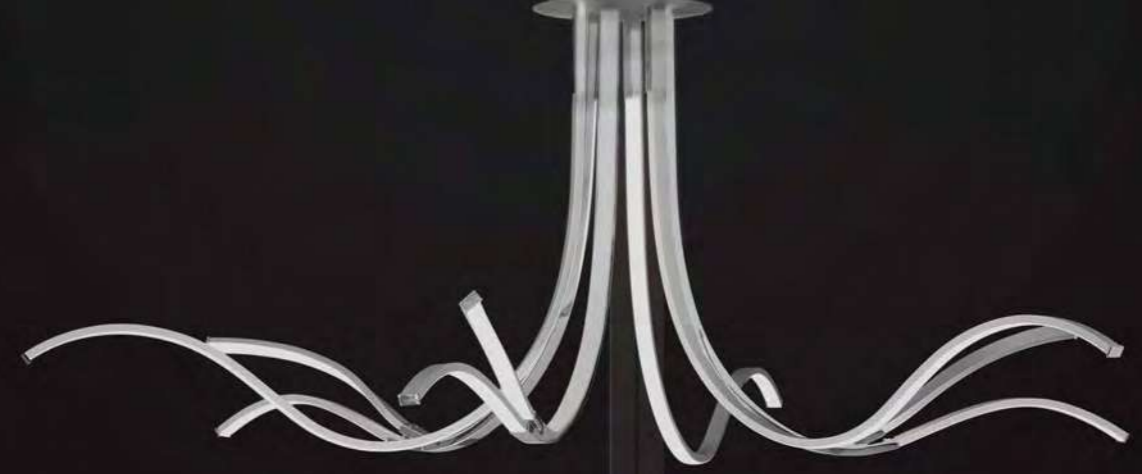

# Corinto

CORINTO, diseñada por José Ignacio Ballester es una familia que nos plantea elementos de trazos muy suaves y armoniosos, insinuando formas y siluetas de los primeros formas arquitectónicas simplificándolas al extremo. Elementos en distintos formatos que nos transmiten la potencia de la luz led domándola mediante sus reguladores de intensidad con los que interactuar, para proporcionarnos una delicada luz ambiental. Aliviando con su presencia ambientes sobrios y recargados, planteando nuevas alternativas, iluminando a la vez que vistiendo.  
CORINTO, tu nuevo clásico...

*CORINTO, designed by José Ignacio Ballester, is a collection that presents elements with smooth and harmonious strokes, insinuating forms and silhouettes based on the primary architectural shapes, simplifying them to the extreme. Elements in different formats that transmit the power of the ledcontrolled-light by means of its intensity regulators, which provide a delicate atmosphere. It may smooth sober and overdecorated spaces with its presence, as a perfect alternative which illuminates while decorating.  
CORINTO, your new classic ...*

OAMI 004721413-002 / 003 / 004

6108

José Ignacio Ballester





6108/6105

6106



**Plafón/ lámpara (convertible)**  
**Ceiling/ pendant Lamp (Convertible)**

Plata Cromo - Silver Chrome  
 Dimmable

**6105**  
 LED 60W 3000K 4800lm



**Plafón/ lámpara (convertible)**  
**Ceiling/ pendant Lamp (Convertible)**

Plata Cromo - Silver Chrome  
 Dimmable

**6106**  
 LED 80W 3000K 6400lm

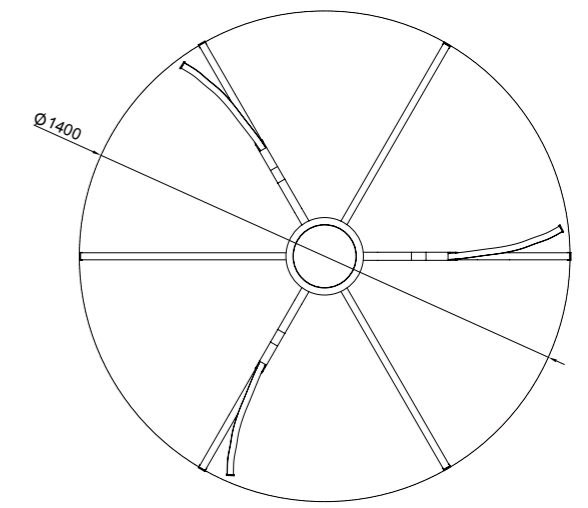
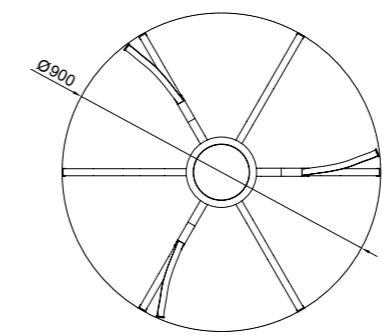
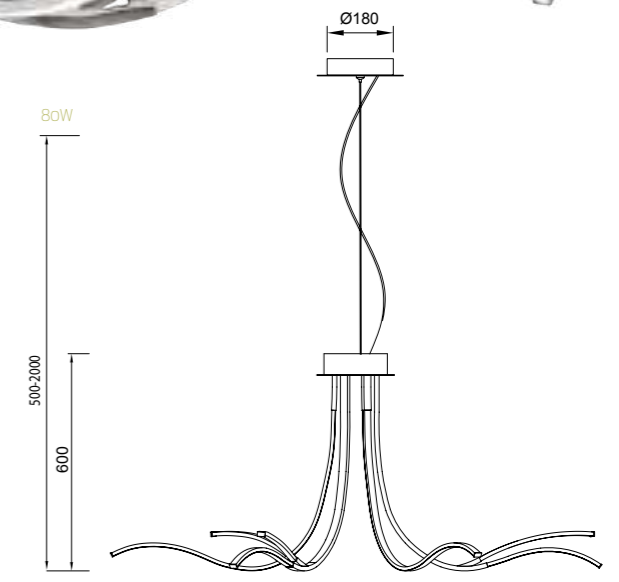
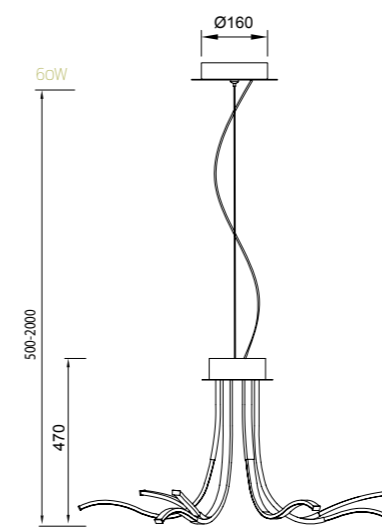

**Aplique - Wall Lamp**

Plata Cromo - Silver Chrome

**6107**  
LED 12W 3000K 960 lm

**Pie De Salón - Floor Lamp**

Plata Cromo - Silver Chrome  
Dimmable

**6108**  
LED 30W 3000K 2400 lm

**Sobremesa - Table Lamp**

Plata Cromo - Silver Chrome  
Dimmable

**6110**  
LED 18W 3000K 1440 lm

**Sobremesa - Table Lamp**

Plata Cromo - Silver Chrome  
Dimmable

**6109**  
LED 12W 3000K 960 lm

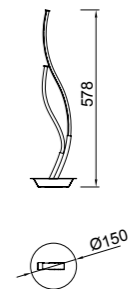
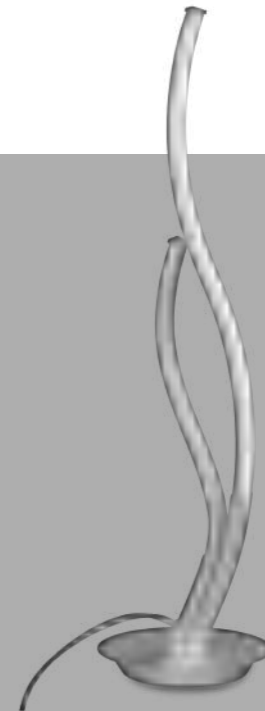
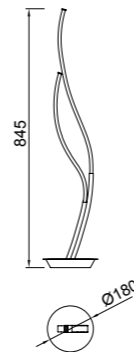
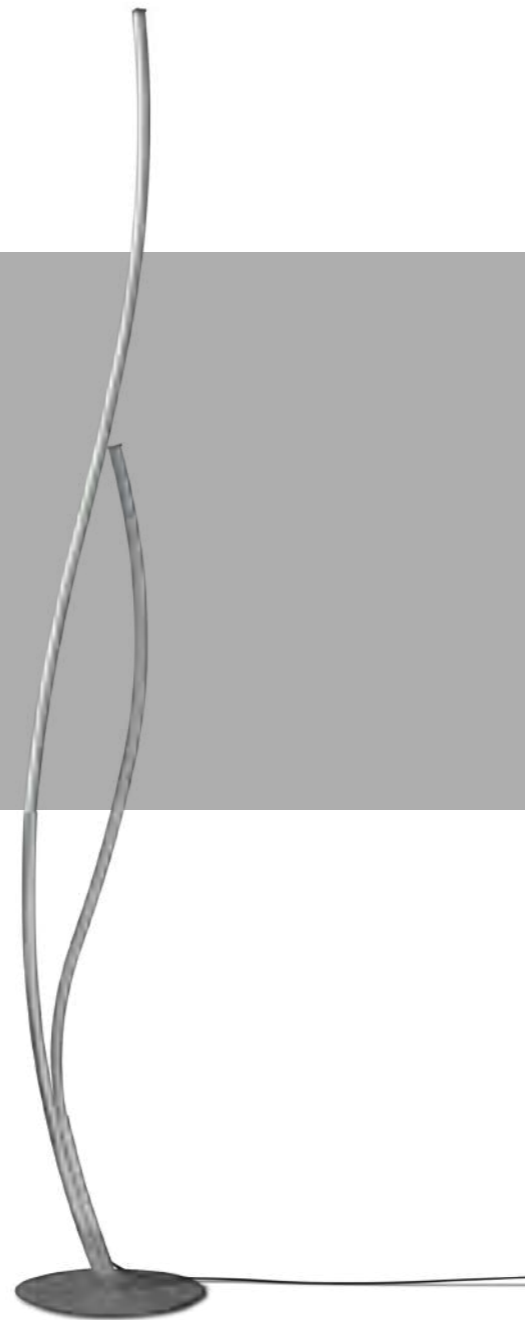
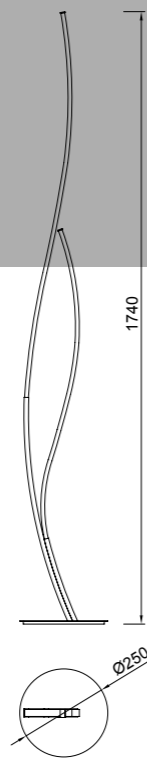
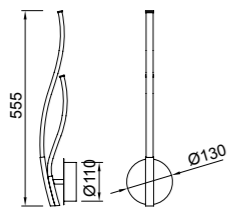
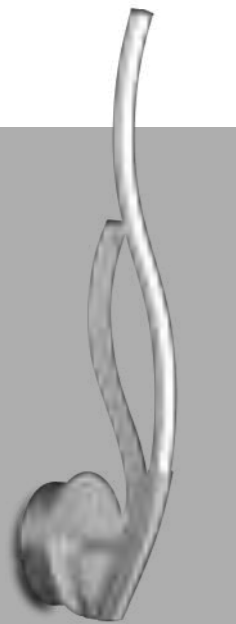



# Cinto

"Cinto" Diseñada por Santiago Sevillano para Mantra.  
Cinto es un juego de contrastes formales entre la linealidad de la luz y la curvatura de sus uniones metálicas que le otorgan un carácter elegante y atemporal ideal para decorar cualquier ambiente sin perder su funcionalidad como elemento de iluminación gracias a la cuidada disposición de las fuentes de luz led.

*"Cinto" has been designed by Santiago Sevillano for Mantra. Cinto is a set of contrasts between the linearity of light and its arch of metallic joints, which deliver an elegant and timeless character. It is ideal to decorate any atmosphere, without losing its functionality as a lighting fixture, thanks to the careful arrangement of LED illumination.*

Santiago Sevillano



6142

OAMI 004721413 - 005 / 006 / 007 / 008 / 009 / 010



Cinto

6122





Lámpara - Pendant Lamp  
Cuero Satinado - Satin antique

6122  
LED 24W 3000K 1950 lm

Lámpara - Pendant Lamp  
Cuero Satinado - Satin antique

6123  
LED 42W 3000K 3360 lm

Plafón - Ceiling Lamp  
Cuero Satinado - Satin antique

6127  
LED 20W 3000K 1600 lm

6128  
LED 28W 3000K 2250 lm

6129  
LED 42W 3000K 3360 lm

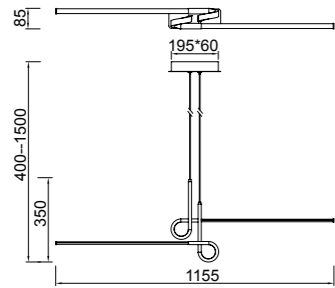
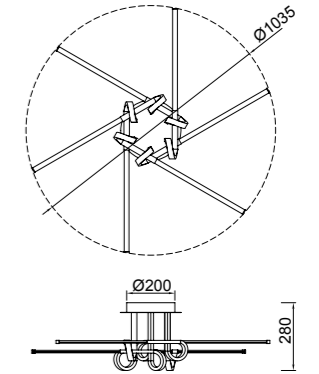
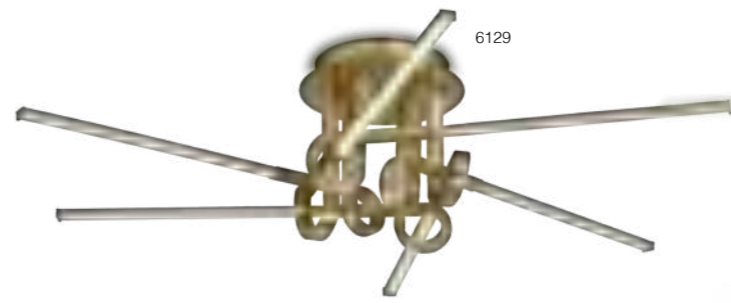
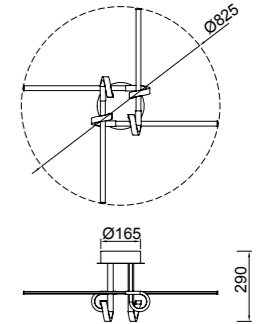
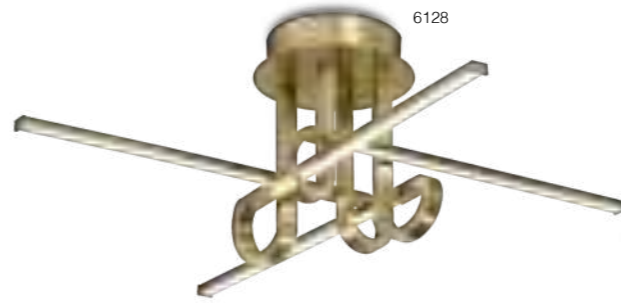
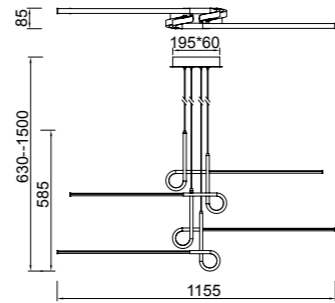
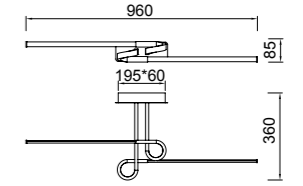
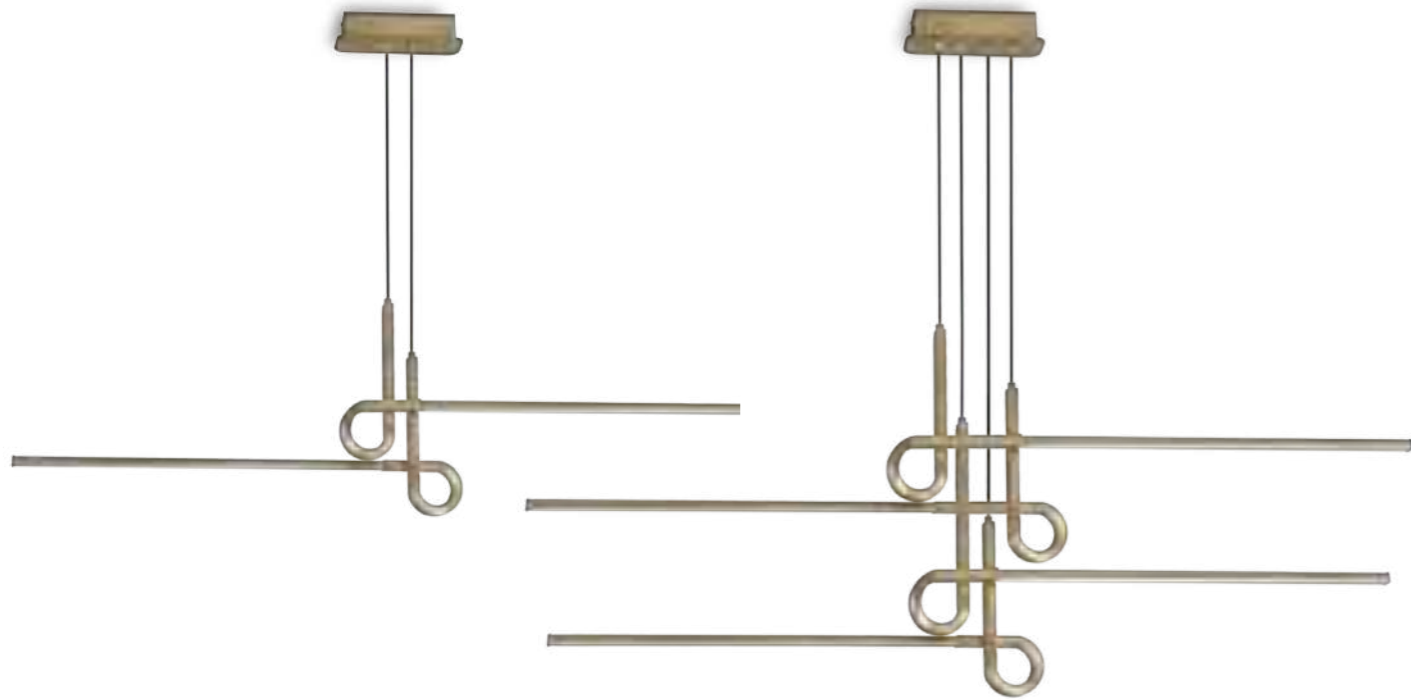



6123



**Lámpara - Pendant Lamp**  
Cromo - Chrome

**6120**  
LED 24W 3000K 1950 lm

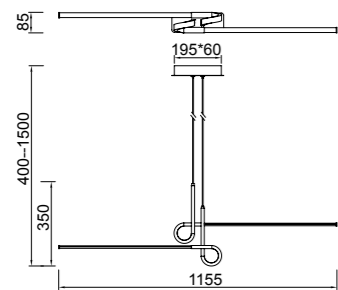
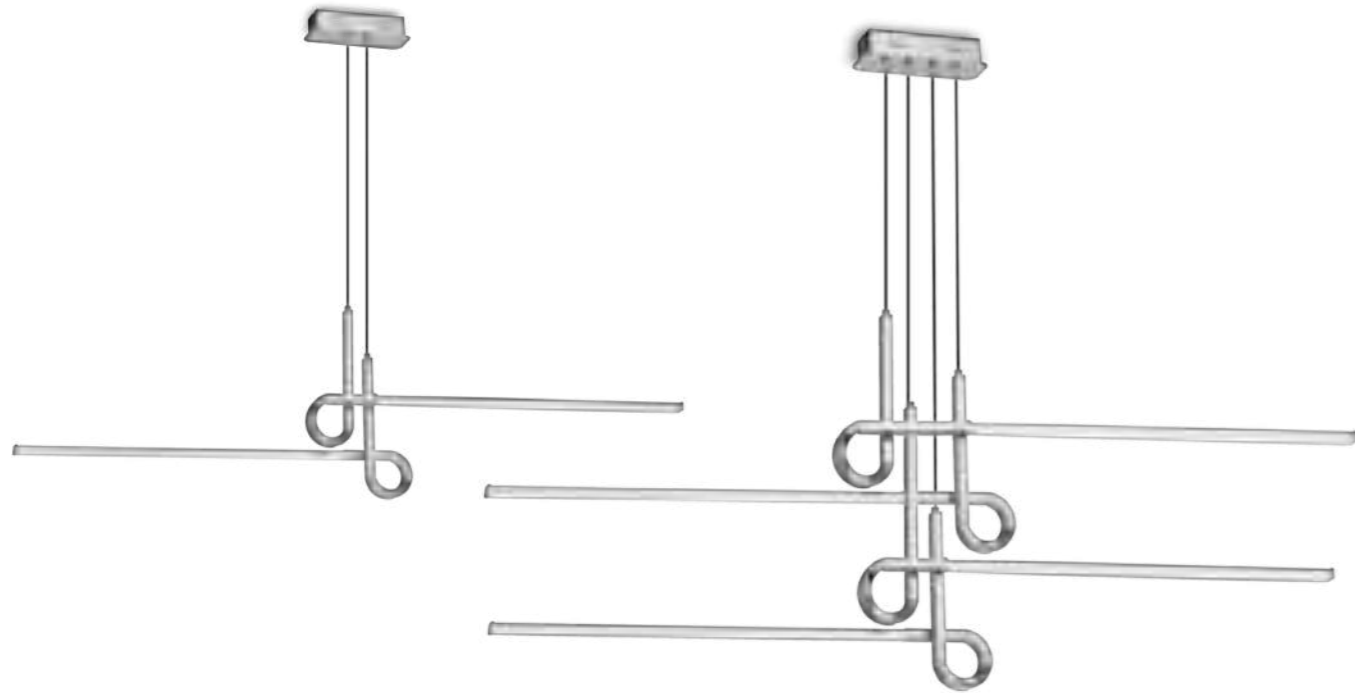

**Lámpara - Pendant Lamp**  
Cromo - Chrome

**6121**  
LED 42W 3000K 3360 lm

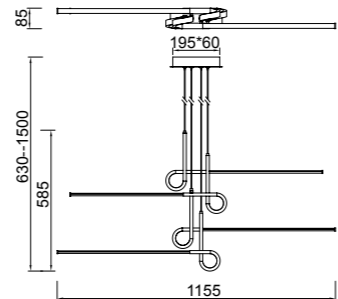
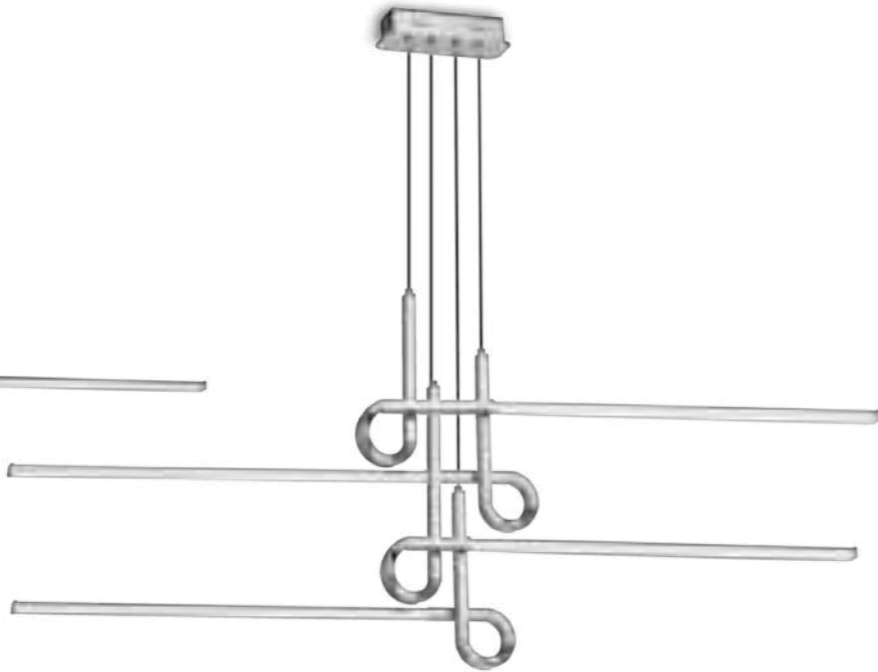

**Plafón - Ceiling Lamp**  
Cromo - Chrome

**6124**  
LED 20W 3000K 1600 lm

**6125**  
LED 28W 3000K 2250 lm

**6126**  
LED 42W 3000K 3360 lm

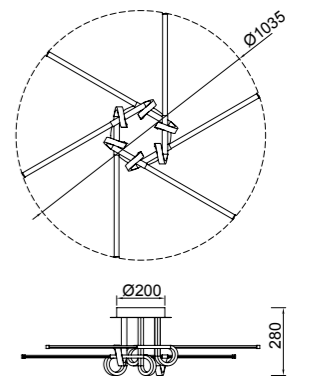
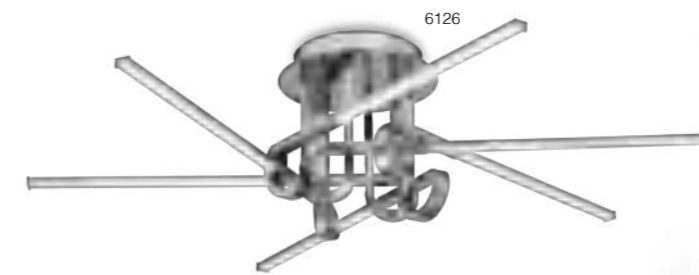
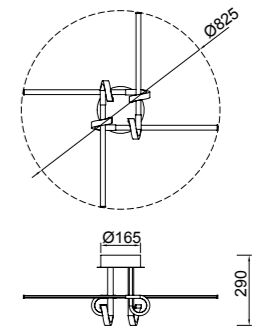
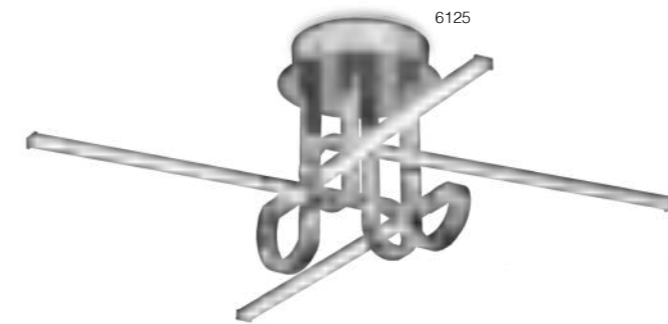
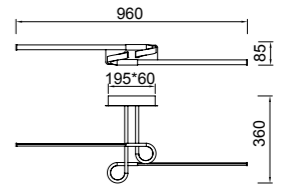

100-240V-50/60Hz CRI>80 Aluminio / Acero / Acrílico - Aluminum / Steel / Acrylic



100-240V-50/60Hz CRI>80 Aluminio / Acero / Acrílico - Aluminum / Steel / Acrylic

**Sobremesa - Table Lamp**  
Cuero Satinado - *Satin antique*

**6141**  
LED 6W 3000K 480 lm

**Sobremesa - Table Lamp**  
Cuero Satinado - *Satin antique*

**6142**  
LED 6W 3000K 480 lm

**Sobremesa - Table Lamp**  
Cromo- *Chrome*

**6135**  
LED 6W 3000K 480 lm

**Sobremesa - Table Lamp**  
Cromo- *Chrome*

**6136**  
LED 6W 3000K 480 lm

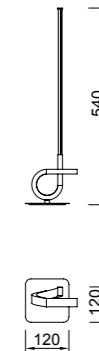
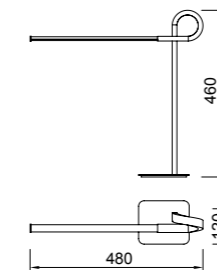
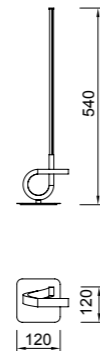
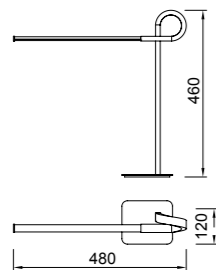



**Pie de Salón -Floor lamp**

Cuero Satinado - *Satin antique*  
Dimmable

**6145**  
LED 7W 3000K 540 lm

**6143**  
LED 20W 3000K 1600 lm

**Pie de Salón -Floor lamp**

Cromo- *Chrome*  
Dimmable

**6144**  
LED 7W 3000K 540 lm

**6137**  
LED 20W 3000K 1600 lm

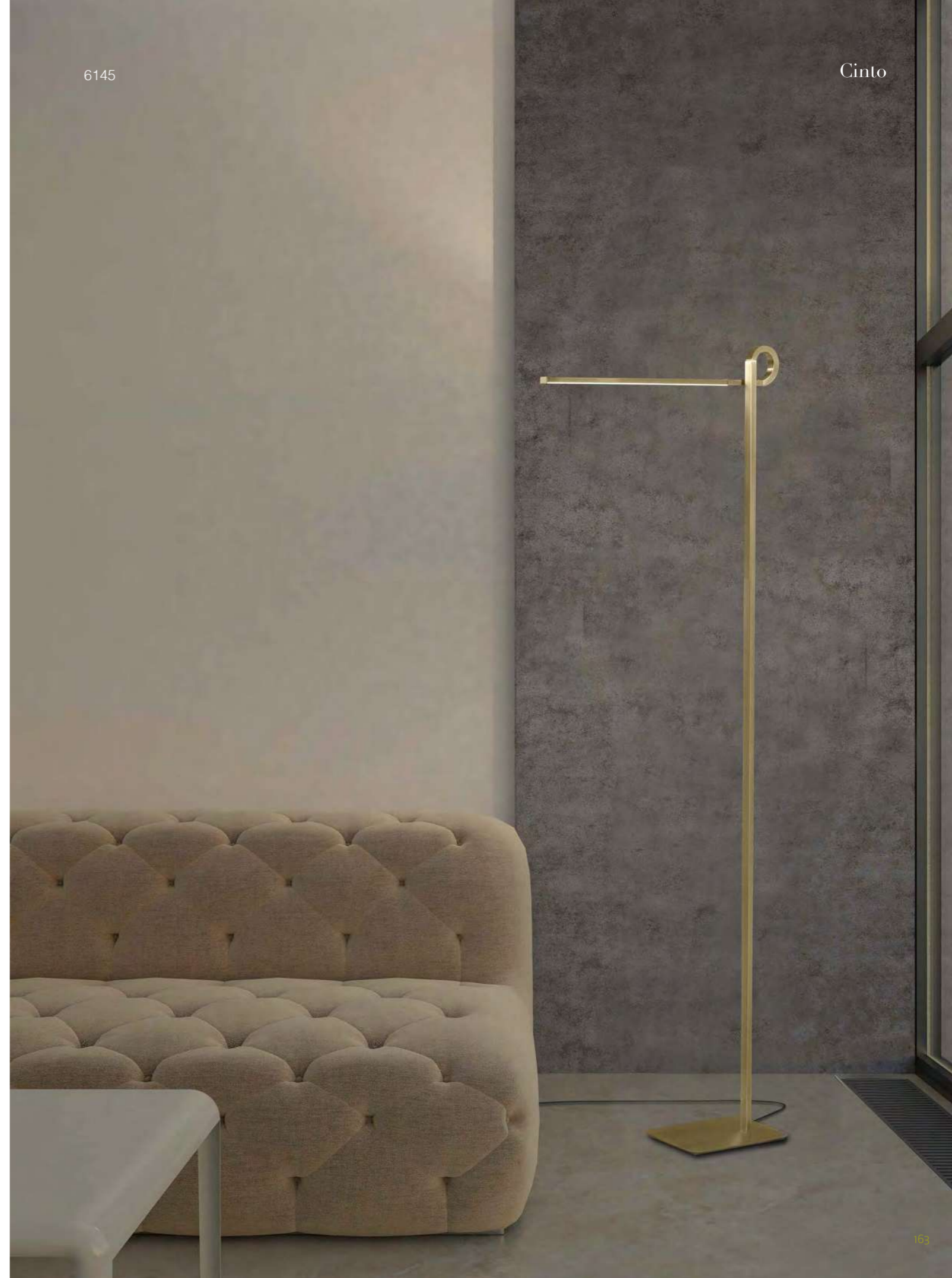

**Plafón - Ceiling lamp**  
Cuero Satinado - *Satin antique*

**6130**  
LED 24W 3000K 1950lm

**Plafón - Ceiling lamp**  
Cromo - *Chrome*

**6131**  
LED 24W 3000K 1950lm

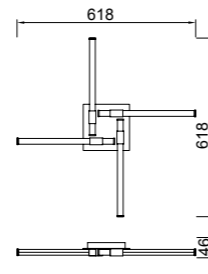
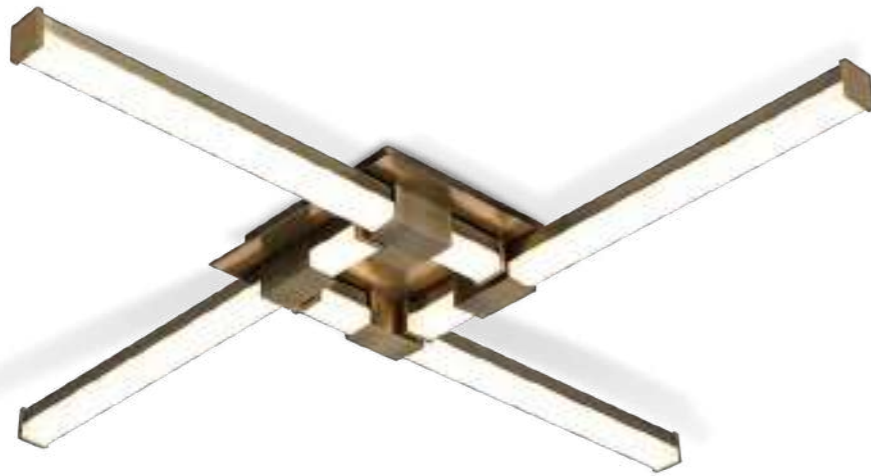
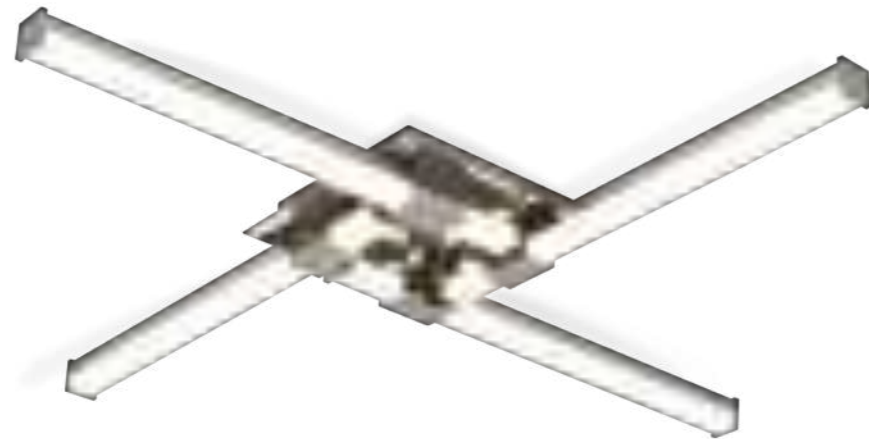

**Aplique - Wall lamp**  
Cuero Satinado - *Satin antique*

**6138**  
LED 6W 3000K 480 lm

**6139**  
LED 12W 3000K 960 lm

**6140**  
LED 20W 3000K 1600 lm

**Aplique - Wall lamp**  
Cromo - *Chrome*

**6132**  
LED 6W 3000K 480 lm

**6133**  
LED 12W 3000K 960 lm

**6134**  
LED 20W 3000K 1600 lm

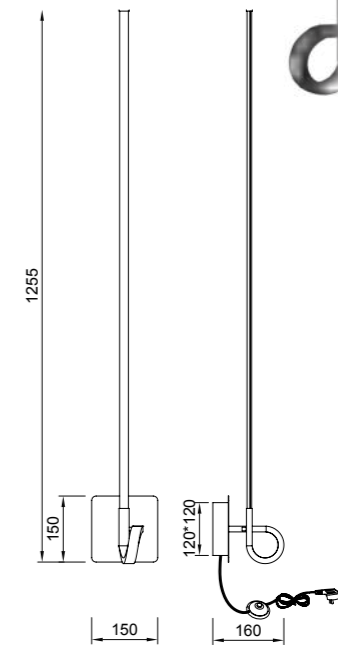
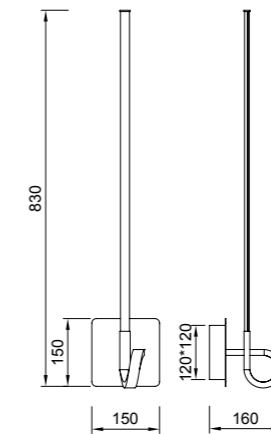
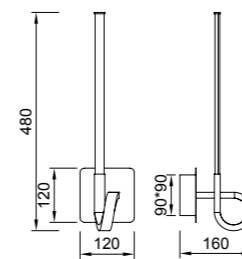



6120



“...contrastes entre la linealidad de la luz y la curvatura”

Santiago Sevillano

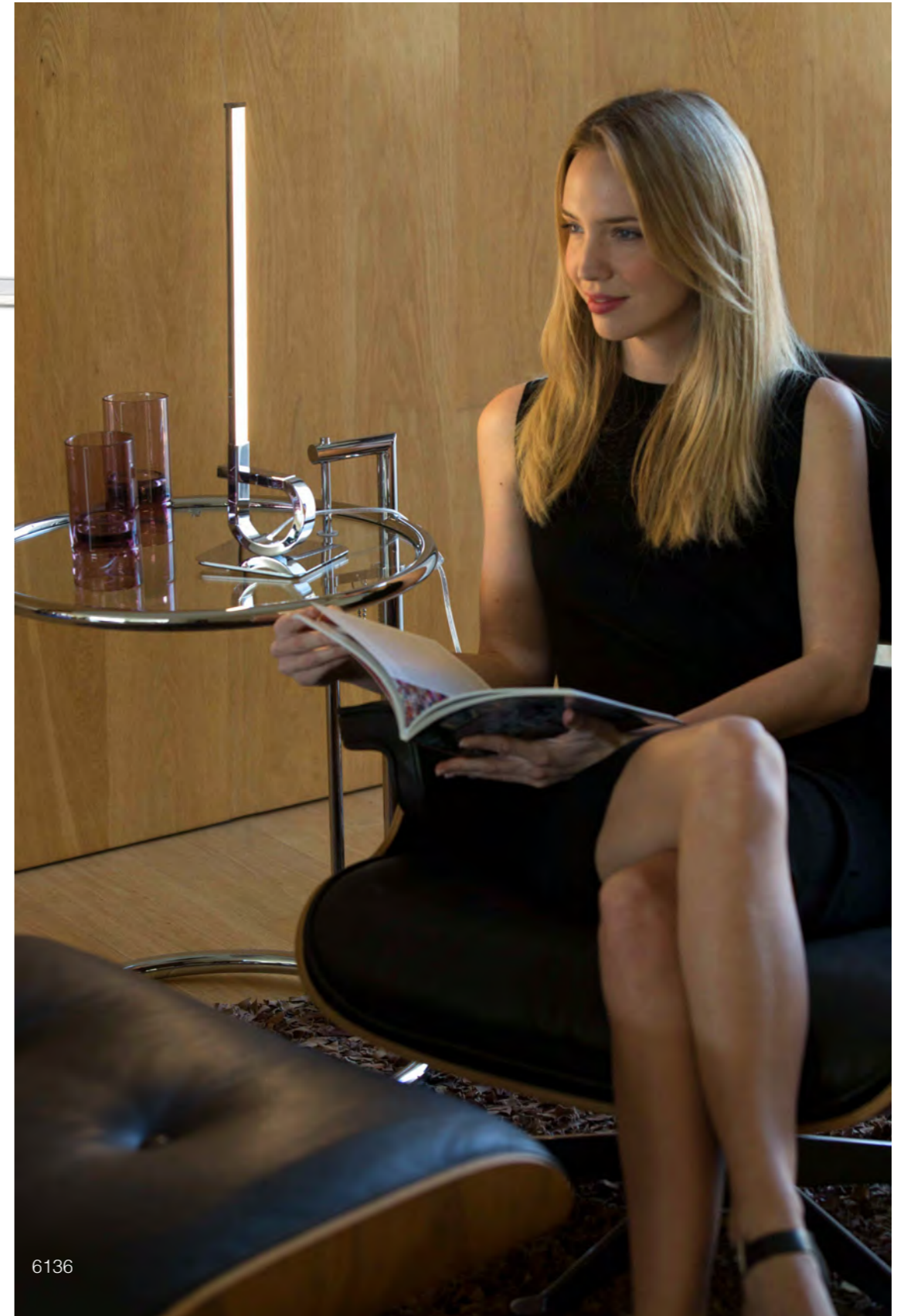

6136

# Ring

RING es un concepto limpio y sugerente que nace de la necesidad de iluminar el vacío, de crear un objeto de la mínima expresión, un producto bello y a la vez funcional. RING está inspirada en la filosofía Zen y su creencia en la espiritualidad del vacío. En RING hemos utilizado el vacío como forma, enmarcándolo dentro de un objeto minimalista, casi escultórico, para crear un aro donde nace la luz, direccionando esta fuente de luz para iluminar el espacio generado en el centro de su estructura. La lámpara está fabricada en inyección de aluminio, material que aporta rigidez y ligereza a la pieza, además, incorpora tecnología LED de alto rendimiento, ideal para ser integrado en su reducido espesor. RING nace para ser la protagonista, un objeto para ser contemplado, opción perfecta para generar ambientes íntimos sin perder eficiencia y funcionalidad.

*RING is a clean and surprising concept that arises from the need to illuminate the void, to create an object of minimal expression, a appealing and functional product. RING is inspired in Zen philosophy and its belief in the spirituality of emptiness. In RING we have used the void as a form, a minimalistic sculptural frame where light is born, directing it to the space generated at the center of its structure. The lamp is made of aluminum injection, material that provides rigidity and lightness to the item; It also incorporates high performance LED technology, perfect to be integrated in its reduced thickness. RING has been born to be the protagonist, an object to be contemplated, a perfect option to generate intimate environments without losing efficiency and functionality.*

Hugo Tejada



6170

OAMI 004721413-013



6171





Lámpara - Pendant Lamp

**6170**  
Blanco-White  
LED 18+5 (up) 23W 3000K 1600 lm

**6171**  
Bronce-Bronze  
LED 18+5 (up) 23W 3000K 1600 lm

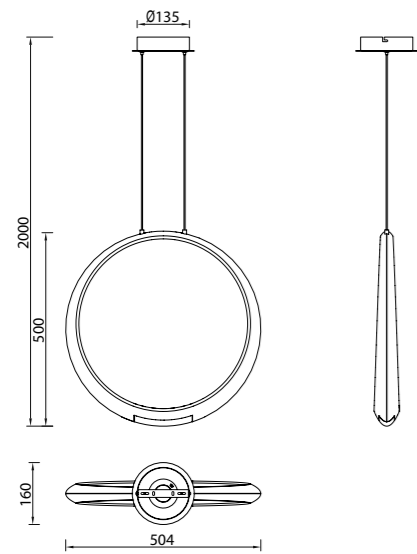

Lámpara - Pendant Lamp

**6172**  
Plata-Silver  
LED 18+5 (up) 23W 3000K 1600 lm

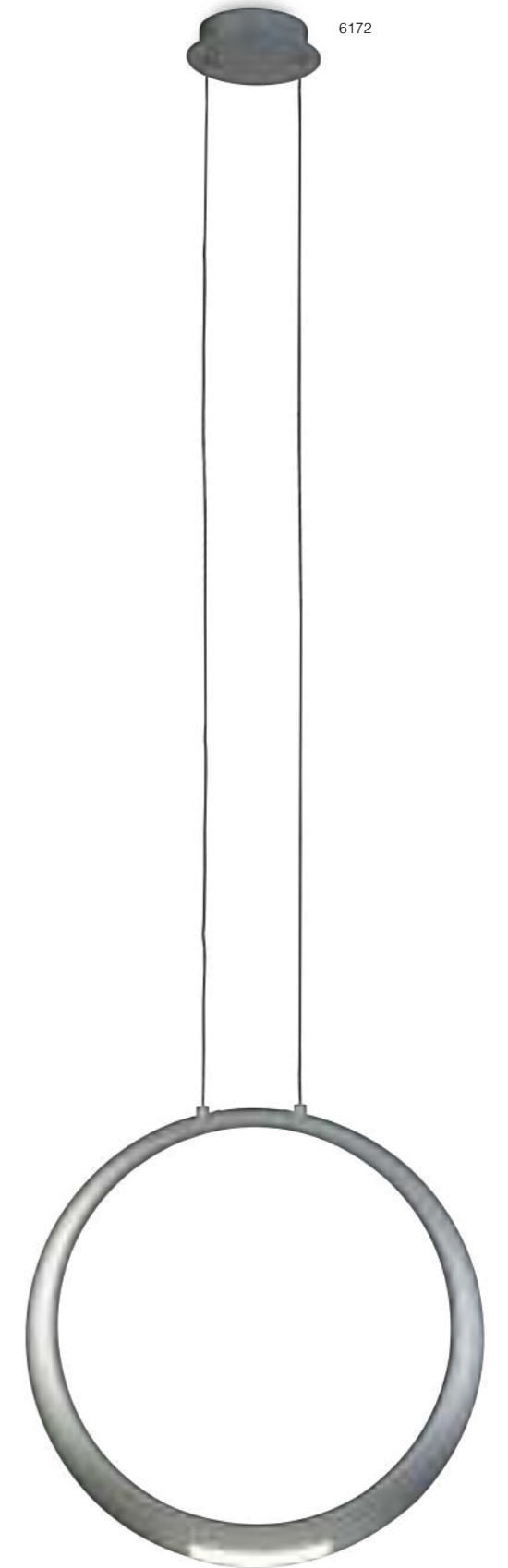
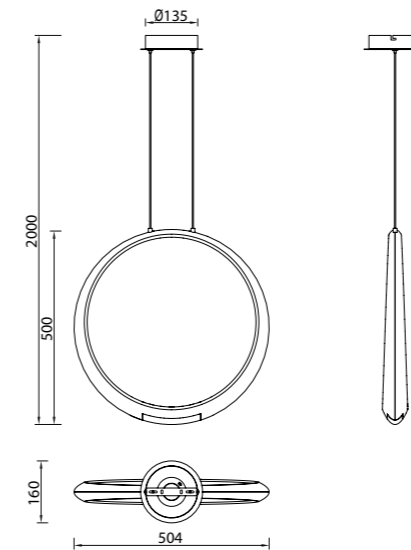



# Jarras

JARRAS es un ejemplo perfecto de iluminación colgante de vidrio vintage moderno. La forma reflectante crea una sensación de simetría y equilibrio, agregando belleza a cada entorno. Disponible en una variedad de opciones de volumen y colores. Jarras es una lujosa colección de iluminación que consigue mucho más brillo.

*JARRAS is a perfect example of trendy vintage glass pendant lighting. Its reflective shape create a sense of symmetry and balance, adding beauty to every environment. Besides, it is available in a variety of volume options and colors, which makes it a very versatile item.*

Santiago Sevillano



OAMI 004721413-019/020/021





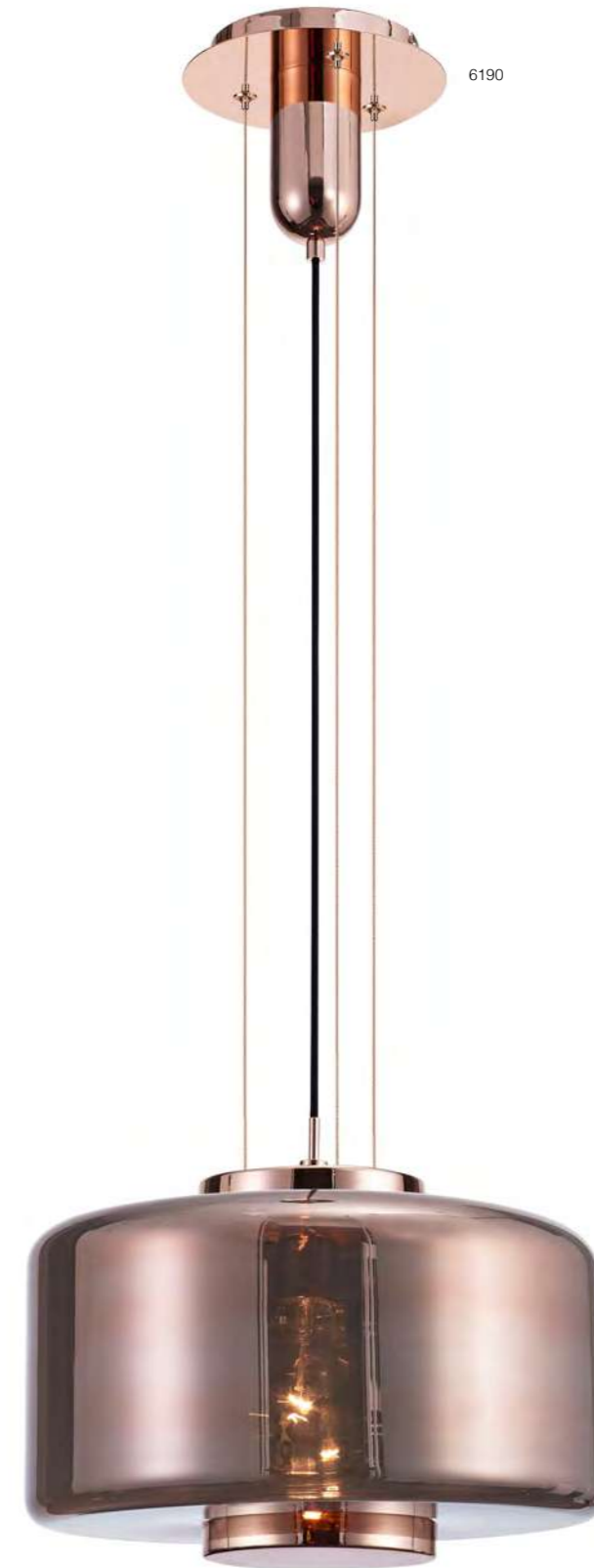
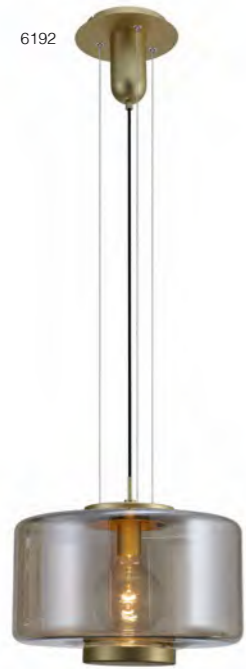

**Lámpara - Pendant Lamp**

**6190** Cobre - Copper  
1x E27 máx.40W/no incl

**6192** Bronce - Bronze  
1x E27 máx.40W/no incl

**6191** Cromo/ Grafito - Chrome/Graphite  
1x E27 máx.40W/no incl

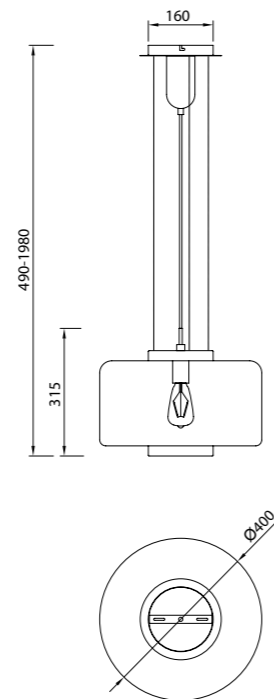

220-240V-50/60Hz Acero/Cristal - Steel/Glass





**Lámpara - Pendant Lamp**

**6193** Cobre - Copper  
1x E27 máx.40W/no incl

**6195** Bronce - Bronze  
1x E27 máx.40W/no incl

**6194** Cromo/Grafito - Chrome/Graphite  
1x E27 máx.40W/no incl

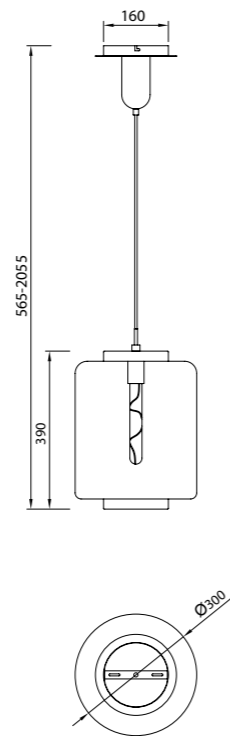

220-240V~50/60Hz Acero/Cristal - Steel/Glass







**Lámpara - Pendant Lamp**

**6196** Cobre - Copper  
1x E27 máx.40W/no incl

**6198** Bronce - Bronze  
1x E27 máx.40W/no incl

**6197** Cromo/Grafito - Chrome/Graphite  
1x E27 máx.40W/no incl

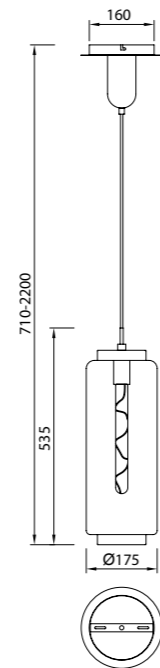

220-240V-50/60Hz Acero/Cristal - Steel/Glass





6200

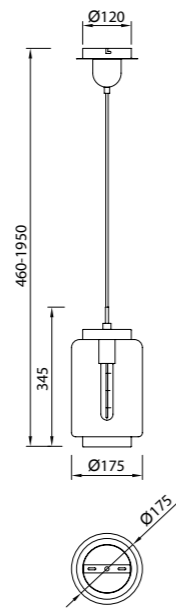

6201



6199

**Lámpara - Pendant Lamp**

**6199** Cobre - Copper  
1x E27 máx.40W/no incl

**6201** Bronce - Bronze  
1x E27 máx.40W/no incl

**6200** Cromo/Grafito - Chrome/Graphite  
1x E27 máx.40W/no incl

**Florón de techo - Ceiling cup**

**6501** Cromo - Chrome 3L

**6500** Cromo - Chrome 5L

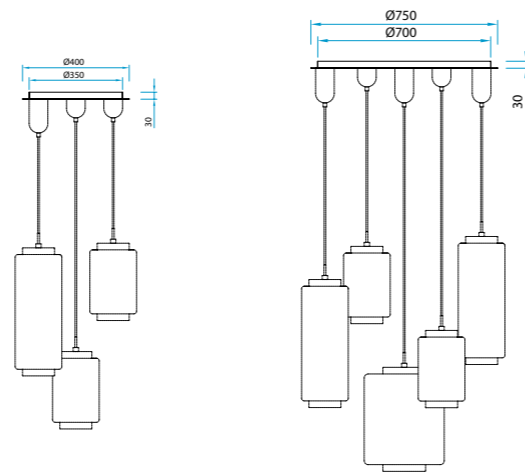

6501 Cromo - Chrome 3L



6500 Cromo - Chrome 5L



220-240V-50/60Hz Acero/Cristal - Steel/Glass







6200

6194

6191

6197

6195

6198

6201

6192

6190

6193

6196

6199





# Lens

Lámparas colgantes de vidrio soplado con bombilla y estilo vintage, bebe de valores tradicionales y del legado de tiempos pasados y los evoluciona de modo magistral aportando una gran ligereza y naturalidad. La luz que compone, inunda en el aire y creciendo en las paredes circundantes, dando una atmósfera interior adquiriendo vida propia, creando diversas composiciones en composición.

*Pendant lamps of blown-up glass with bulb and vintage style, with traditional values and the legacy of past times, evolving in a masterful way, providing a great lightness and simplicity. The light fills the air, growing in the surrounding walls, creating a private atmosphere in a peculiar and unique style.*

Santiago Sevillano

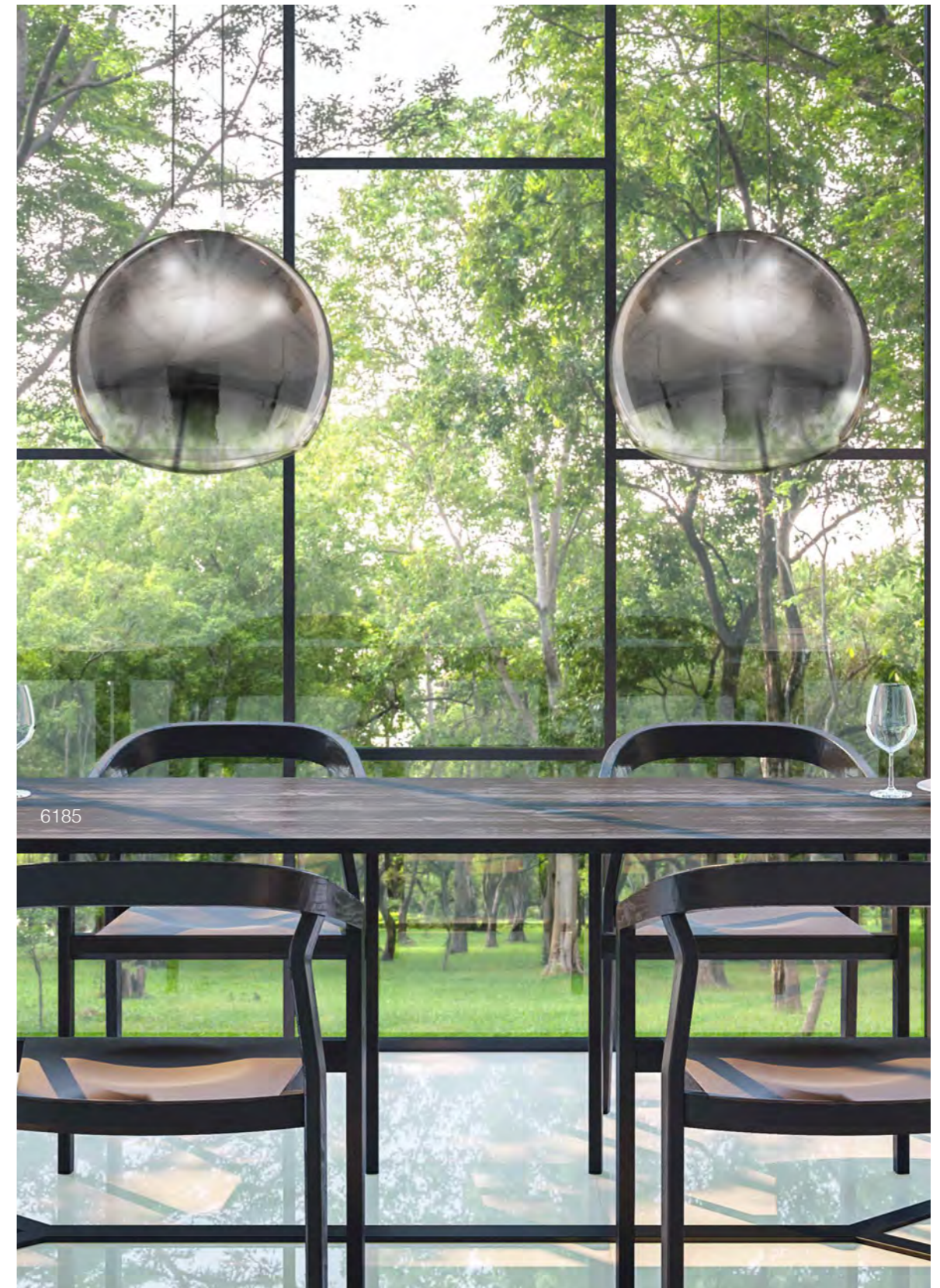

OAMI004721413-018



Lámpara - Pendant Lamp

**6187** Grafito-Graphite  
1 x G9 máx.8W/no incl

**6186** Grafito-Graphite  
1 x E14 máx.40W/no incl

**6185** Grafito-Graphite  
1 x E27 máx.40W/no incl

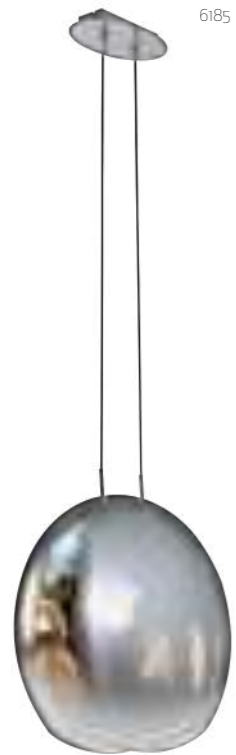

6185

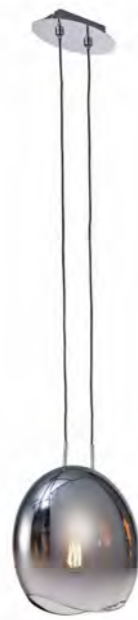

6186



6187

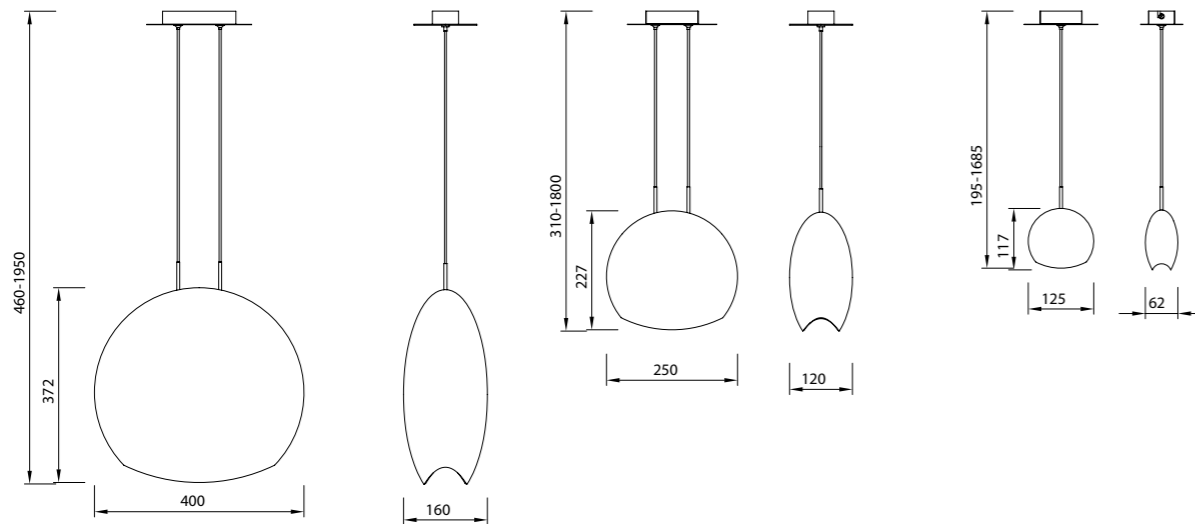

Lámpara - Pendant Lamp

**6189** Grafito-Graphite  
3x E14 máx.40W/no incl

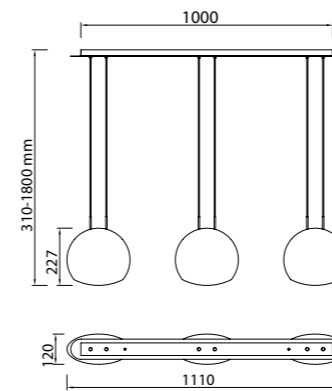

220-240V-50/60Hz Acero/Cristal - Steel/Glass



220-240V-50/60Hz Acero/Cristal - Steel/Glass

# JAZZ

Jazz es la destilación formal de elegancia y estilo en los años 50 como forma de ritmo constructivo. “..Cerrar los ojos. Imaginaros que estáis en Nueva York, callejeando y unas notas musicales salen de dentro de un club. Imaginaros un contrapunto de sensaciones paseando por el barrio de Akasaka de Tokio y, dentro de ese caos encuentras un oasis de paz con notas melódicas, rodeado de madera y fotos de grandes glorias.” Jazz se inspira formalmente en trompetas, saxos y trombones clásicos, con detalles únicos de este estilo de música. Juega con la estética vintage y se inspira en ella para darnos unas forma cálidas.

*Jazz is the formal distillation of elegance and style of the 50 's as a shape of constructive rhythm. Close your eyes. Imagine that you are in New York, hanging around and some musical notes come out of a club. Imagine a counterpoint of sensations, strolling along the Akasaka suburb in Tokyo, and within that chaos, you find an oasis of peace with melodic notes, surrounded by wood and pictures on ancient glories. "Jazz" is formally inspired on trumpets, saxophones and classical trombones, with unique details of this music style. It plays with the "Vintage" aesthetics and it is inspired on it to convey its warm shapes.*

Santiago Sevillano

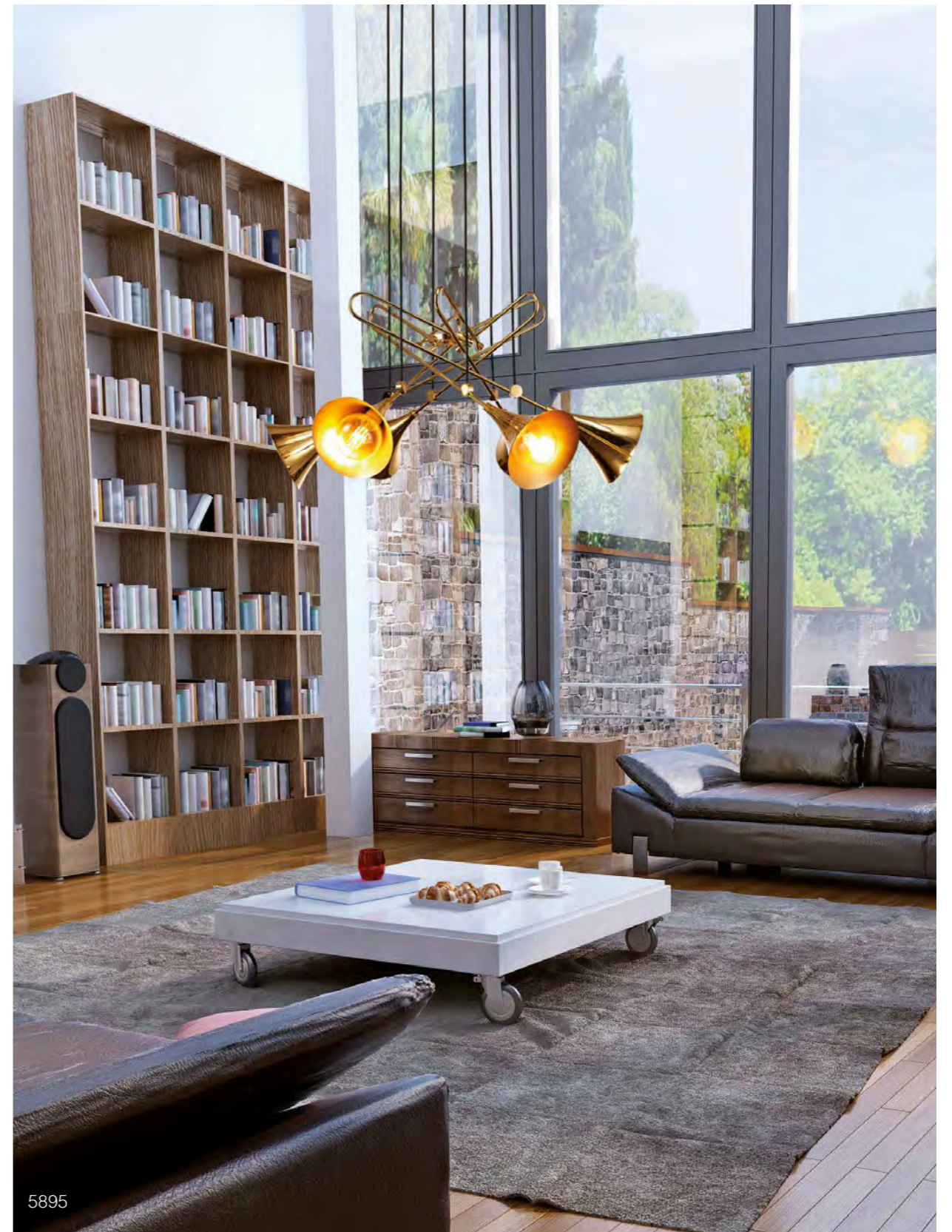

5895

OAMI 004022663-0002



**Semi Plafón - Semi Ceiling Lamp**  
Oro - Gold

**5897**  
5x E27 máx.20W/no incl

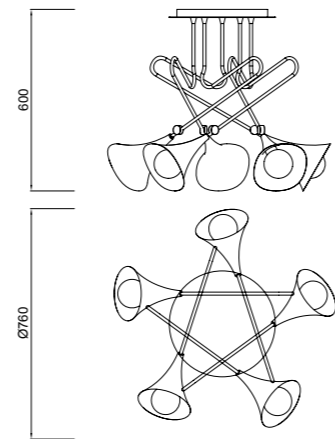

220-240V- 50/60Hz Hierro - Iron



**Lámpara - Pendant Lamp**  
Oro/Cable negro- Gold/Black wire

**5895**  
6x E27 máx.20W/no incl

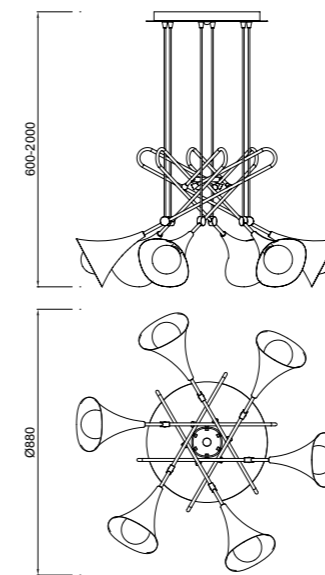
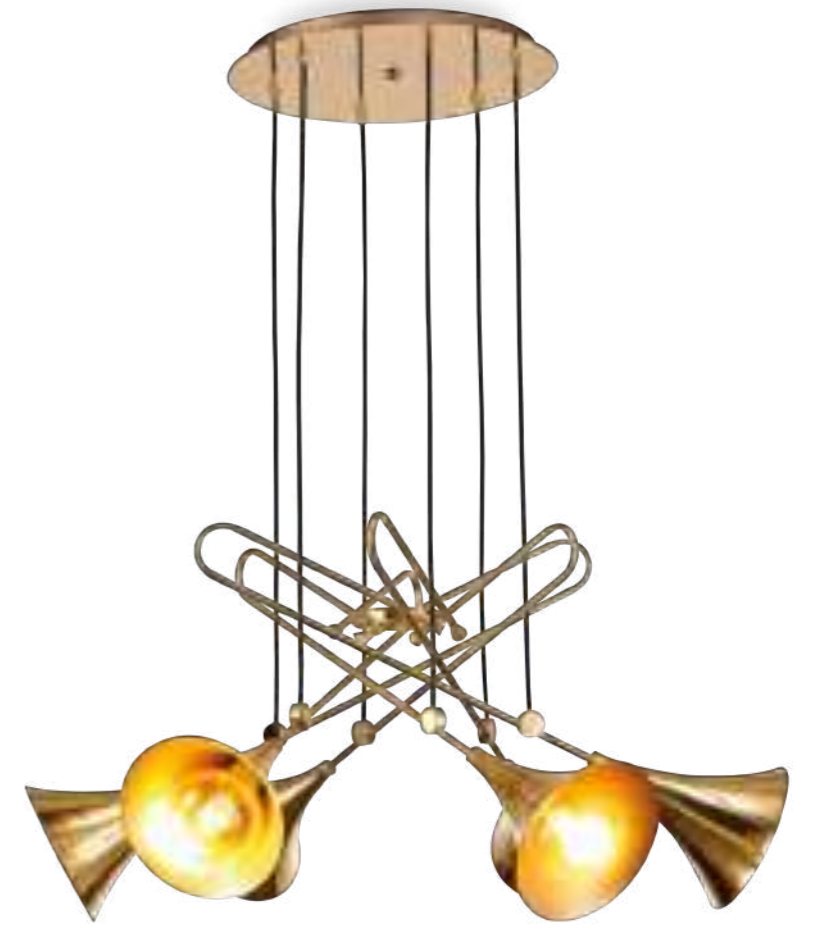

220-240V- 50/60Hz Hierro - Iron

**Colgante - Pendant Lamp**

Oro/Cable negro- Gold/Black wire

**5896**

3x E27 máx.20W/no incl

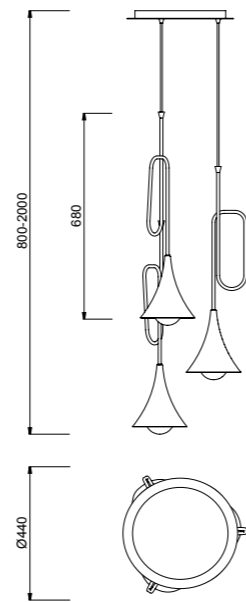

220-240V- 50/60Hz Hierro - Iron





**Colgante - Pendant Lamp**

Oro/Cable negro- Gold/Black wire

**5899**

1x E27 máx.20W/no incl

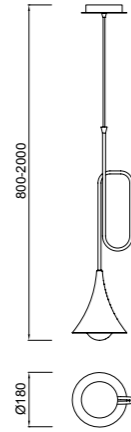

**Colgante - Pendant Lamp**

Oro/Cable negro- Gold/Black wire

**5908**

1x E27 máx.20W/no incl

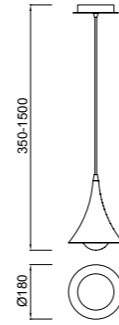

**Sobremesa - Table Lamp**

Oro - Gold

**5909**

1x E27 máx.20W/no incl  
Clase protección:II

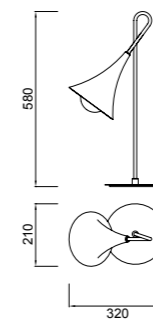

**Aplique - Wall Lamp**

Oro - Gold

**5898**

1x E27 máx.20W/no incl  
Clase protección:I

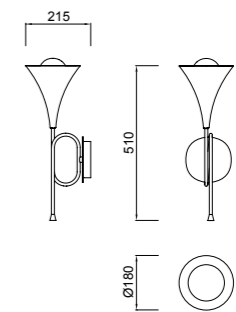

220-240V~ 50/60Hz Hierro - Iron



220-240V~ 50/60Hz Hierro - Iron

# ALBORÁN

Alborán sigue la línea del minimalismo que define el estilo del diseñador, otro concepto de líneas puras donde el efecto de luz prevalece frente a la forma. Una vez más, Hugo Tejada utiliza elementos naturales como fuente de inspiración. En esta ocasión el movimiento del mar y los reflejos creados por la proyección de la luz sirven como elemento inspirador para crear la lámpara Alborán. El efecto lumínico es el elemento clave, la composición en diversas alturas de sus pantallas metálicas permite que la luz fluya entre las mismas creando una degradación de intensidades con gran sutileza y elegancia, un objeto cálido y amigable que no pasará desapercibido.

*Alborán follows the line of minimalism that defines the style of the designer, another concept of pure lines where the effect of light prevails over form. Once again, Hugo Tejada uses natural elements as a source of inspiration. On this occasion the movement of the sea and the reflections created by the projection of light serve as an inspiring element to create the lamp Alborán. The light effect is the key element, the composition at different heights of its metallic screens allows light to flow between them creating a degradation of intensities with great subtlety and elegance, a warm and friendly object that will not go unnoticed.*

Hugo Tejada



OAMI 003854025-0005



**Colgante - Pendant Lamp**  
Blanco - White

**5860**  
3x E27 máx.40W/no incl

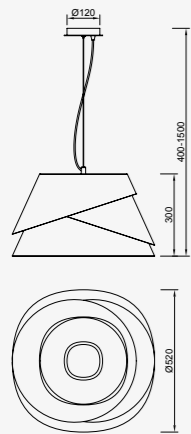

**Colgante - Pendant Lamp**  
Blanco - White

**5861**  
1x E27 máx.40W/no incl

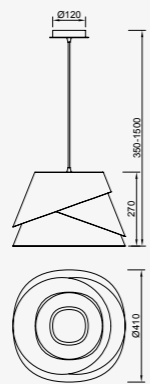

**Colgante - Pendant Lamp**  
Blanco - White

**5862**  
1x E27 máx.40W/no incl

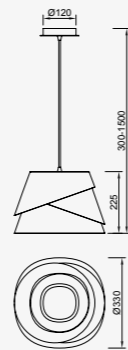

220-240V-50/60Hz Aluminio/Hierro - Aluminium/Iron

5861



**Sobremesa - Table Lamp**  
Blanco - White

**5863**  
1x E27 máx.40W/no incl

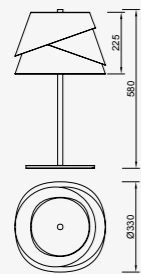

**Pie De Salón - Floor Lamp**  
Blanco - White

**5864**  
1x E27 máx.40W/no incl

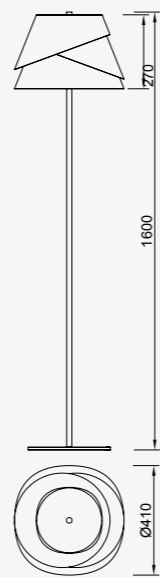

220-240V-50/60Hz Aluminio/Hierro - Aluminium/Iron



5863 - 5864





# MANTA

Tiene su origen en la investigación sobre superficies 4D, al mismo tiempo que hemos tomado como referencia la sinuosidad que define la cúpula del Oceanografic. Su característica radica en que con tan solo un emisor de luz, es capaz de repartir la iluminación de manera equitativa a casi los 360°. Gracias a sus formas onduladas debidamente unidas.

*It has his origin in the research on 4D surfaces, at the same time that we have taken as reference the sinuosity that defines the dome of the Iconic Oceanografic of Valencia, designed by Felix Candela. The characteristic is that: with only one light emitter, it is able to distribute the lighting equitably to almost 360°. Thanks to his undulating forms duly joined.*

Santiago Sevillano



OAMI 003854025-0007



Lámpara - *Pendant Lamp*  
Cromo-Blanco - *Chrome-White*

5876  
LED 20W 3000K 1600 lm

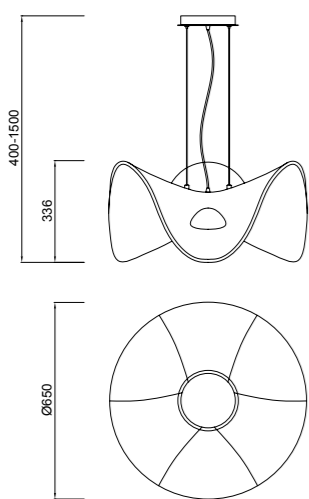



# NUR

Un trazo de luz sin principio ni fin conforma el diseño de esta original colección de iluminación, INFINITY. Diseñada por Jose Ignacio Ballester para Mantra y fundamentada sobre las bases de la anterior colección NUR; INFINITY es una colección de luz led efectiva, limpia y minimalista, como podremos comprobar es sus versiones de colgantes y lámparas, donde sus líneas quedan elegantemente suspendidas en el aire. La componen elementos en varios formatos como lámparas en distintas medidas, plafón a techo, así como también un sobremesa. Están construidas en un ligero perfil de aluminio, con difusor de policarbonato mate, el cual nos permite el realizar y adaptar sus giros y curvaturas de forma limpia. Con dos acabados diferenciadores, uno, el plata combinado con cromo, luz led 4000k. para ambientes más vanguardistas y modernos. Y otro el acabado en forja, con luz cálida de 3000k. para ambientes un tanto más clásicos o incluso rústicos.

*An illuminated line without beginning nor end, conforms this original lighting range. Designed by José Ignacio Ballester for mantra and based on the previous collection NUR; INFINITY is an effective lighting range, pure and minimalist, with its elegant lines in suspension. It is composed by several shapes and sizes, in ceiling, chandelier or table lamp. Constructed with a light and profiled in chrome, with polycarbonate mat diffuser, which allows to realize and adapt the curves, and turns. With two differentiating versions, one in silver combined with chrome, with led 3000k, for avant-garde and modern atmosphere. And the other, in brown oxide, with warm light 2800k, for classic or rustic ambient.*

Jose I.Ballester & Santiago Sevillano



OAMI Reg. 002621698-0007 / 002621698-0008 / 002621698-0009 / 002621698-0010 / 002621698-0011 / 002621698-0012



**Colgante - Pendant Lamp**  
Plata Cromo - Silver Chrome

**4980**  
LED 40W 3000K 3200 lm  
100/240V

**4995** Dimmable   
LED 40W 3000K 3200 lm  
220/240V

**Colgante - Pendant Lamp**  
Plata Cromo - Silver Chrome

**4987**  
LED 40W 3000K 3200 lm  
100/240V

**4997** Dimmable   
LED 40W 3000K 3200 lm  
220/240V

**Colgante - Pendant Lamp**  
Plata Cromo - Silver Chrome

**5002**  
LED 50W 3000K 3900lm  
100/240V

**5820** Dimmable   
LED 50W 3000K 3900lm  
220/240V

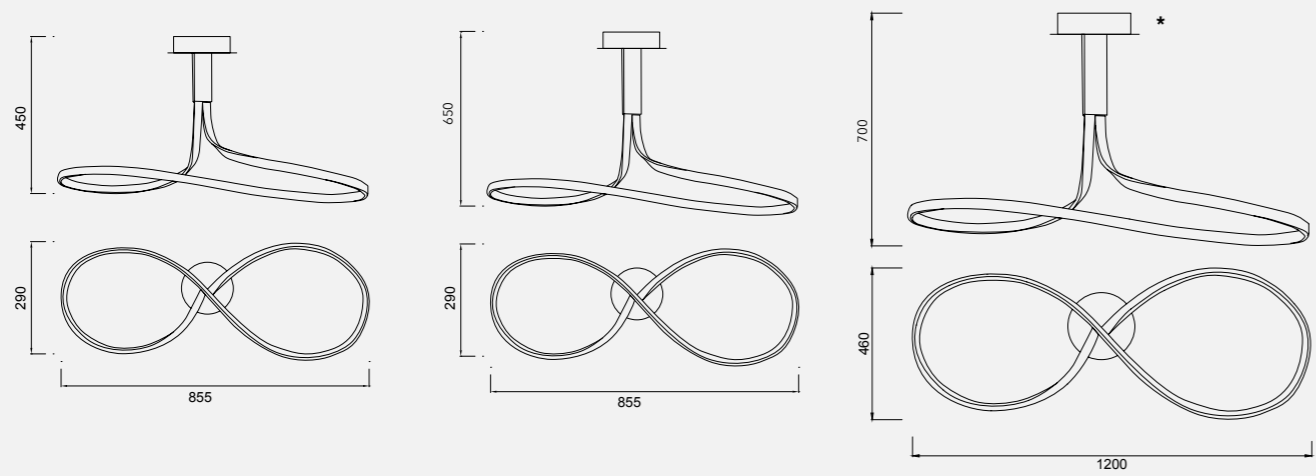









CRI >80    Aluminio / Acrílico / Acero - Aluminium / Acrylic / Steel







5002 - 5820



**Colgante - Pendant Lamp**  
Blanco - White

**6000** Dimmable   
LED 40W 2800K 3200 lm  
220/240V

**6000K**  
LED 40W 4000K 3200 lm  
100/240V

**Colgante - Pendant Lamp**  
Blanco - White

**6003** Dimmable   
LED 40W 2800K 3200 lm  
220/240V

**6003K**  
LED 40W 4000K 3200 lm  
100/240V

**Colgante - Pendant Lamp**  
Blanco - White

**6006** Dimmable   
LED 50W 2800K 3900lm  
220/240V

**6006K** Dimmable   
LED 50W 4000K 3900lm  
100/240V

**Colgante - Pendant Lamp**  
Forja - Brown oxide

**5360**  
LED 40W 2800K 3200 lm  
100/240V

**5826** Dimmable   
LED 40W 2800K 3200 lm  
220/240V

**Colgante - Pendant Lamp**  
Forja - Brown oxide

**5825**  
LED 40W 2800K 3200 lm  
100/240V

**5707** Dimmable   
LED 40W 2800K 3200 lm  
220/240V

**Colgante - Pendant Lamp**  
Forja - Brown oxide

**5806**  
LED 50W 2800K 3900lm  
100/240V

**5831** Dimmable   
LED 50W 2800K 3900lm  
220/240V

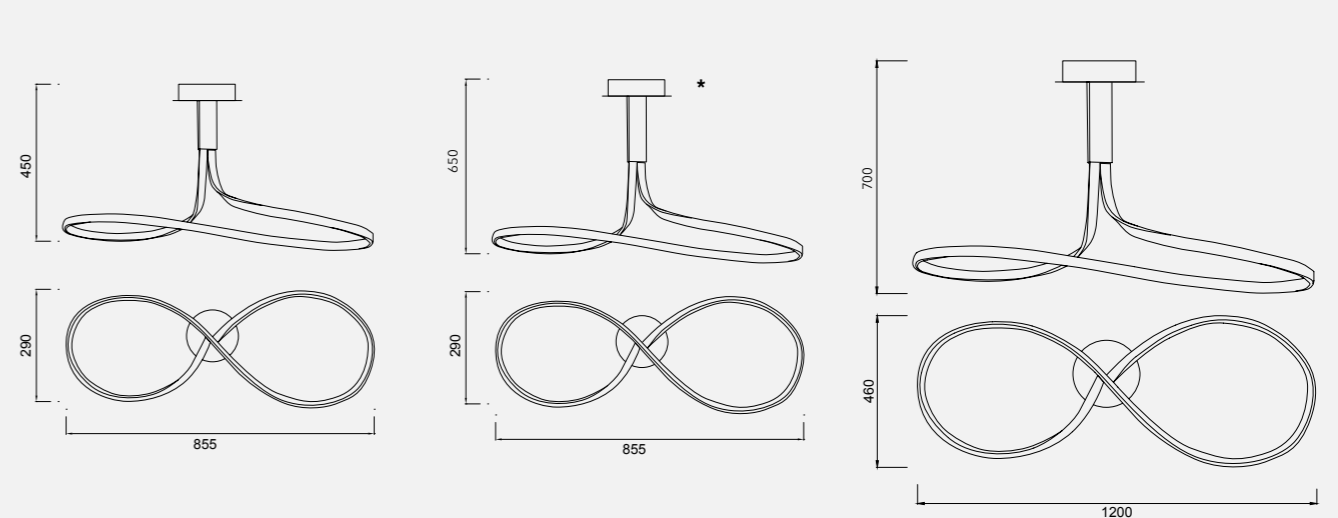
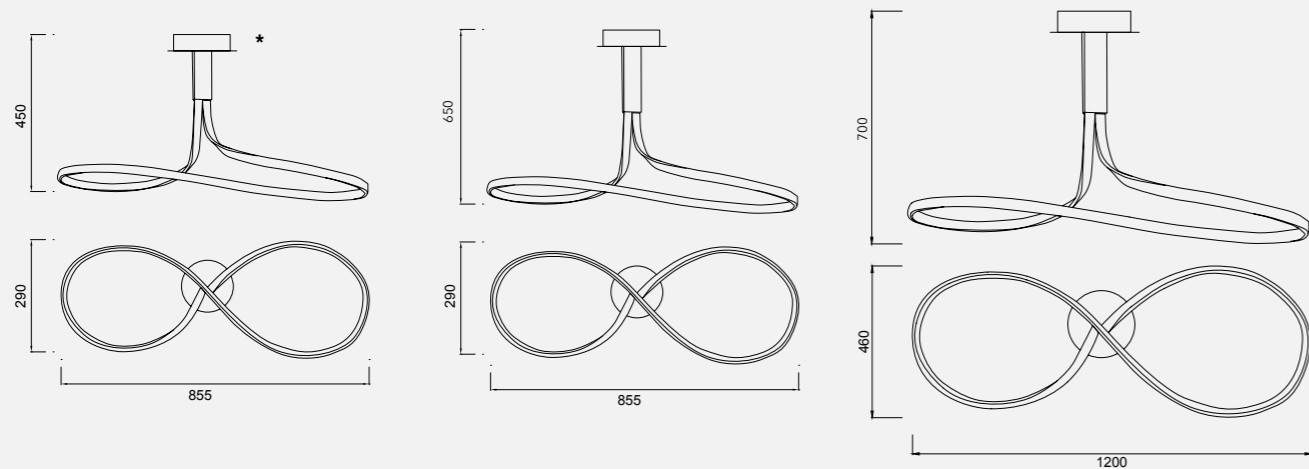

CRI >80 Aluminio / Acrílico / Acero - Aluminium / Acrylic / Steel



CRI >80 Aluminio / Acrílico / Acero - Aluminium / Acrylic / Steel

**Colgante - Pendant Lamp**  
Plata Cromo - Silver Chrome

**4982**  
LED 30W 3000K 2400 lm  
100/240V

**4996** Dimmable   
LED 30W 3000K 2400 lm  
220/240V



**Colgante - Pendant Lamp**  
Plata Cromo - Silver Chrome

**4981**  
LED 50W 3000K 4000 lm  
100/240V

**4998** Dimmable   
LED 50W 3000K 4000 lm  
220/240V



**Colgante - Pendant Lamp**  
Plata Cromo - Silver Chrome

**5003**  
LED 80W 3000K 6200 lm  
100/240V

**5821** Dimmable   
LED 80W 3000K 6200 lm  
220/240V

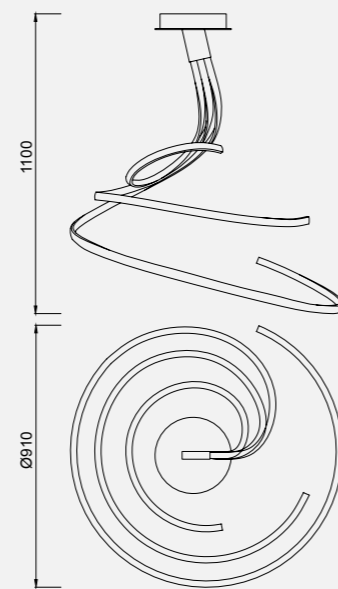
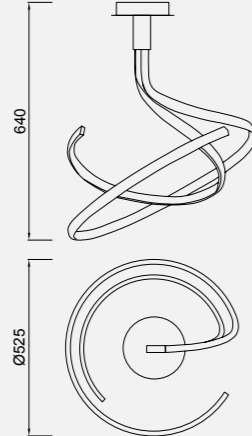
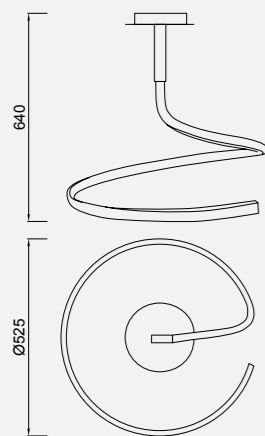

CRI >80 Aluminio / Acrílico / Acero - Aluminium / Acrylic / Steel



4882 - 4996





**Colgante - Pendant Lamp**  
Blanco - White

**6007** Dimmable   
LED 80W 2800K 6200 lm  
220/240V

**6007K** Dimmable   
LED 80W 4000K 6200 lm  
220/240V

**Colgante - Pendant Lamp**  
Blanco - White

**6001** Dimmable   
LED 50W 2800K 4000 lm  
220/240V

**6001K**  
LED 50W 4000K 4000 lm  
100/240V

**Colgante - Pendant Lamp**  
Blanco - White

**6002** Dimmable   
LED 30W 2800K 2400 lm  
220/240V

**6002K**  
LED 30W 4000K 2400 lm  
100/240V

**Colgante - Pendant Lamp**  
Forja - Brown oxide

**5362**  
LED 30W 2800K 2400 lm  
100/240V

**5829** Dimmable   
LED 30W 2800K 2400 lm  
220/240V

**Colgante - Pendant Lamp**  
Forja - Brown oxide

**5361**  
LED 50W 2800K 4000 lm  
100/240V

**5827** Dimmable   
LED 50W 2800K 4000 lm  
220/240V

**Colgante - Pendant Lamp**  
Forja - Brown oxide

**5807**  
LED 80W 2800K 6200 lm  
100/240V

**5832** Dimmable   
LED 80W 2800K 6200 lm  
220/240V

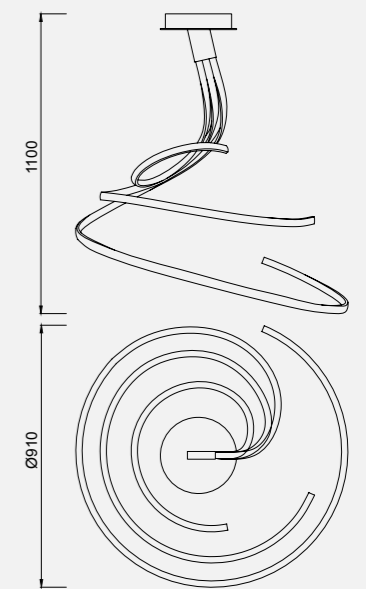
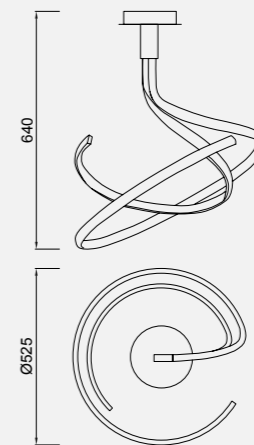
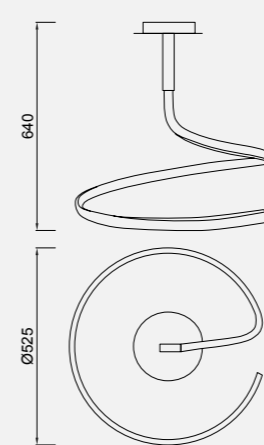
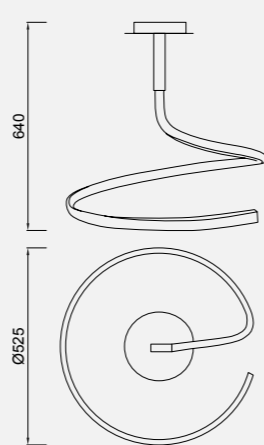
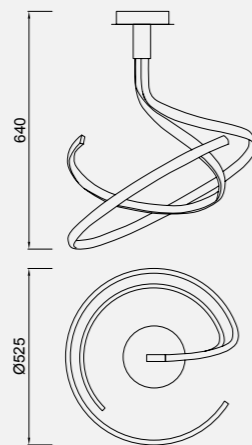
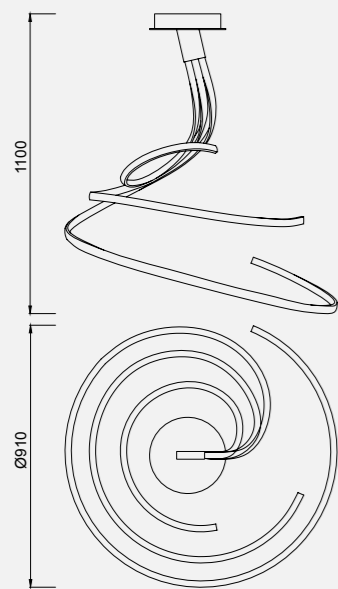

CRI >80 Aluminio / Acrílico / Acero - Aluminium / Acrylic / Steel



CRI >80 Aluminio / Acrílico / Acero - Aluminium / Acrylic / Steel







**Pie De Salón - Floor Lamp**  
Plata Cromo - Silver Chrome

**4983** Dimmable  
LED 20W 3000K 1800 lm

**Pie De Salón - Floor Lamp**  
Plata Cromo - Silver Chrome

**5001** Dimmable  
LED 20W 3000K 1800 lm

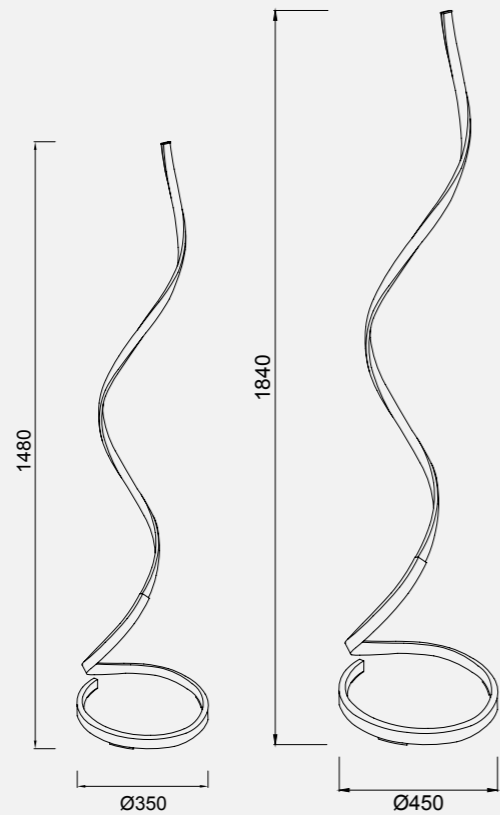

3000K ON/OFF DIMMER Dimmable LED 20W / LED 20W 30,000h ON / OFF 30,000h 5 years warranty LED IP20

220-240V~ 50/60Hz CRI >80 Aluminio / Acrílico / Acero - Aluminium / Acrylic / Steel

A++ A Energy Rating, No Flicker, CE Marking



**Pie De Salón - Floor Lamp**  
Blanco - White

**6009** Dimmable  
LED 20W 2800K 1800 lm

**6009K** Dimmable  
LED 20W 4000K 1800 lm

**Pie De Salón - Floor Lamp**  
Blanco - White

**6010** Dimmable  
LED 20W 2800K 1800 lm

**6010K** Dimmable  
LED 20W 4000K 1800 lm

**Pie De Salón - Floor Lamp**  
Forja - Brown oxide

**5363** Dimmable  
LED 20W 2800K 1800 lm

**Pie De Salón - Floor Lamp**  
Forja - Brown oxide

**5805** Dimmable  
LED 20W 2800K 1800 lm





**Aplique - Wall Lamp**

Plata Cromo - Silver Chrome

**4985**  
LED 10W 3000K 850lm  
220/240V Clase II

**5000** Touch Dimmer   
LED 10W 3000K 850lm  
120/240V Clase II

**Plafón - Ceiling Lamp**

Plata Cromo - Silver Chrome

**4984**  
LED 34W 3000K 2600lm  
100/240V Clase I

**4999** Dimmable   
LED 34W 3000K 2600lm  
220/240V Clase I

**Sobremesa - Table Lamp**

Plata Cromo - Silver Chrome

**4986**  
LED 15W 3000K 1200lm  
220/240V Clase II

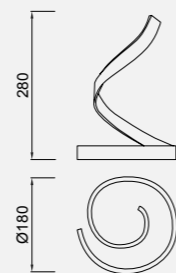
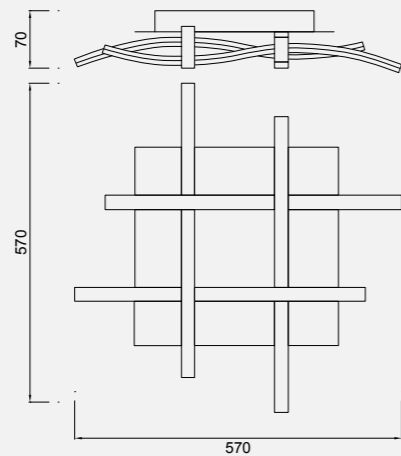
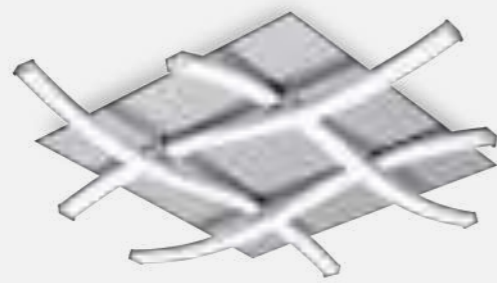
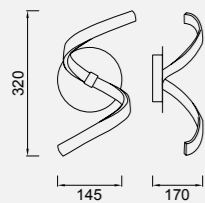

CRI >80 Aluminio / Acrílico / Acero - Aluminium / Acrylic / Steel



4986



**Aplique - Wall Lamp**  
Blanco - White

**6005** Touch Dimmer  
LED 10W 2800K 850lm  
120/240V Clase II

**6005K**  
LED 10W 4000K 850lm  
220/240V Clase II

**Plafón - Ceiling Lamp**  
Blanco - White

**6004** Dimmable  
LED 34W 2800K 2600lm  
220/240V Clase I

**6004K**  
LED 34W 4000K 2600lm  
220/240V Clase I

**Sobremesa - Table Lamp**  
Blanco - White

**6008**  
LED 15W 2800K 1200lm  
220/240V Clase II

**6008K**  
LED 15W 4000K 1200lm  
220/240V Clase II

**Aplique - Wall Lamp**  
Forja - Brown oxide

**5365**  
LED 10W 2800K 850lm  
220/240V Clase II

**5830** Touch Dimmer  
LED 10W 2800K 850lm  
120/240V Clase II

**Plafón - Ceiling Lamp**  
Forja - Brown oxide

**5364**  
LED 34W 2800K 2600lm  
100/240V Clase I

**5828** Dimmable  
LED 34W 2800K 2600lm  
220/240V Clase I

**Sobremesa - Table Lamp**  
Forja - Brown oxide

**5366**  
LED 15W 2800K 1200lm  
220/240V Clase II

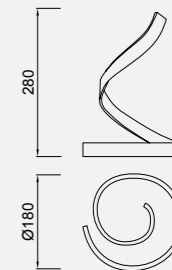
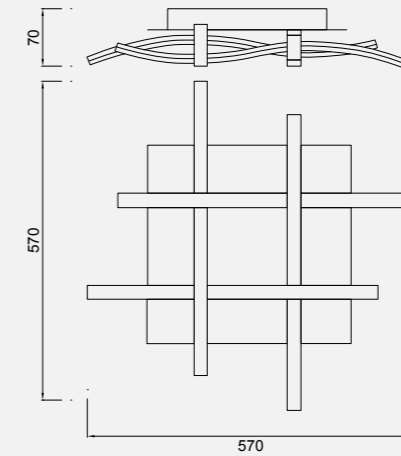
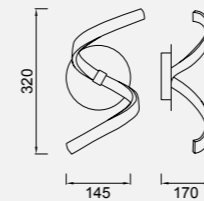
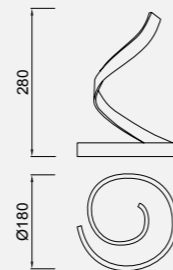
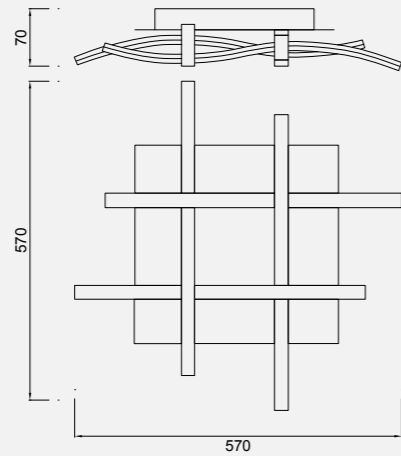
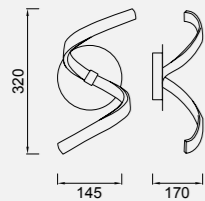
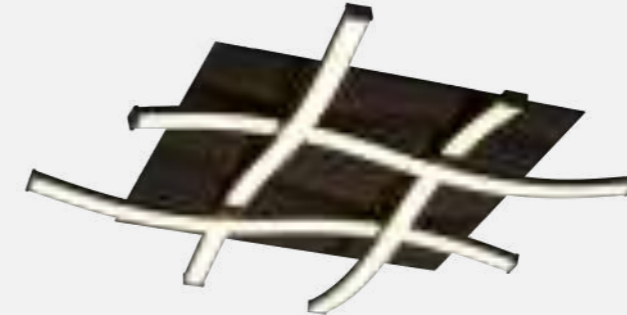
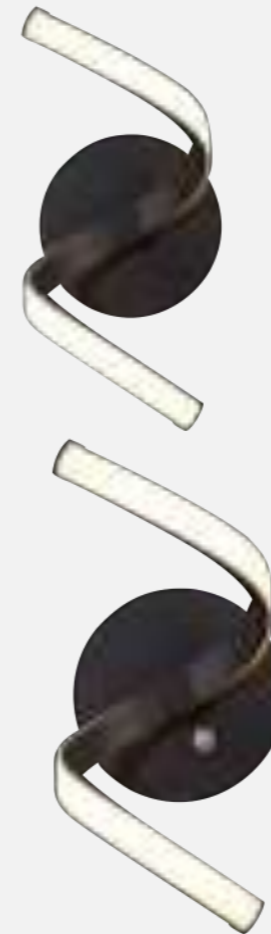
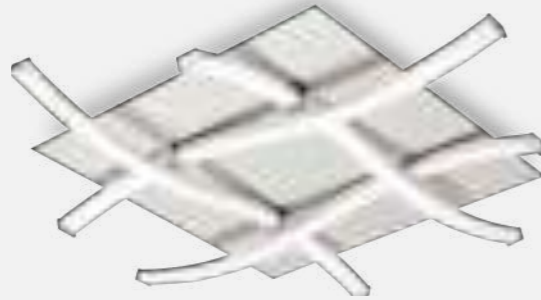
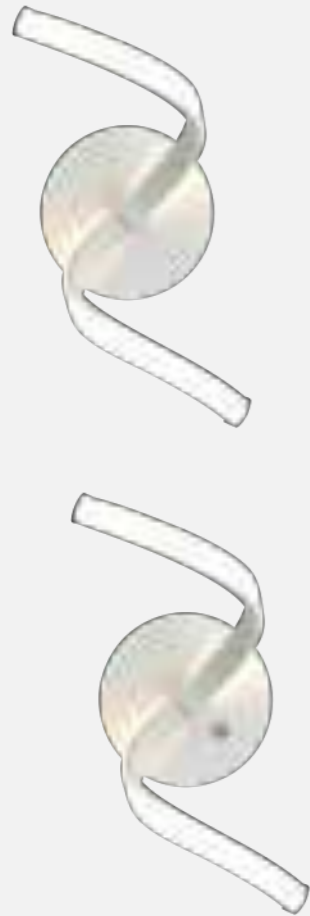

CRI >80 Aluminio / Acrílico / Acero - Aluminium / Acrylic / Steel



CRI >80 Aluminio / Acrílico / Acero - Aluminium / Acrylic / Steel



# INFINITY

Un trazo de luz sin principio ni fin conforma el diseño de esta original colección de iluminación, INFINITY. Diseñada por José Ignacio Ballester para Mantra y fundamentada sobre las bases de la anterior colección NUR; INFINITY es una colección de luz led efectiva, limpia y minimalista, como podremos comprobar es sus versiones de colgantes y lámparas, donde sus líneas quedan elegantemente suspendidas en el aire. La componen elementos en varios formatos como lámparas en distintas medidas, plafón a techo, así como también un sobremesa. Están construidas en un ligero perfil de aluminio, con difusor de policarbonato mate, el cual nos permite el realizar y adaptar sus giros y curvaturas de forma limpia. Con dos acabados diferenciadores, uno, el plata combinado con cromo, luz led 4000k. para ambientes más vanguardistas y modernos. Y otro el acabado en forja, con luz cálida de 3000k. para ambientes un tanto más clásicos o incluso rústicos.

*An illuminated line without beginning nor end, conforms this original lighting range. Designed by José Ignacio Ballester for mantra and based on the previous collection NUR; INFINITY is an effective lighting range, pure and minimalist, with its elegant lines in suspension. It is composed by several shapes and sizes, in ceiling, chandelier or table lamp. Constructed with a light and profiled in chrome, with polycarbonate mat diffuser, which allows to realize and adapt the curves, and turns. With two differentiating versions, one in silver combined with chrome, with led 3000k, for avant-garde and modern atmosphere. And the other, in brown oxide, with warm light 2800k, for classic or rustic ambient.*

José Ignacio Ballester



OAMI 003105923-0001

**Plafón - Ceiling Lamp**  
Plata Cromo - Silver Chrome

**5382**  
LED 30W 3000K 2500 lm

**5727** Dimmable  
LED 30W 3000K 2500 lm

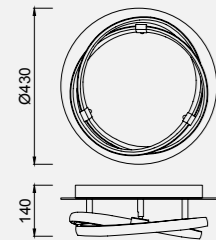

**Colgante - Pendant Lamp**  
Plata Cromo - Silver Chrome

**5384**  
LED 30W 3000K 2500 lm

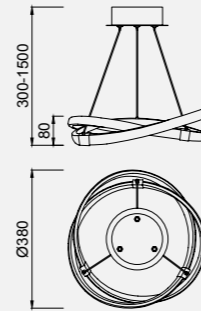

**Colgante - Pendant Lamp**  
Plata Cromo - Silver Chrome

**5380**  
LED 42W 3000K 3400 lm

**5725** Dimmable  
LED 42W 3000K 3400 lm



**Colgante - Pendant Lamp**  
Plata Cromo - Silver Chrome

**5381**  
LED 60W 3000K 4500 lm

**5726** Dimmable  
LED 60W 3000K 4500 lm



**Sobremesa - Table Lamp**  
Plata Cromo - Silver Chrome

**5383**  
LED 12W 3000K 1000 lm  
Clase; II

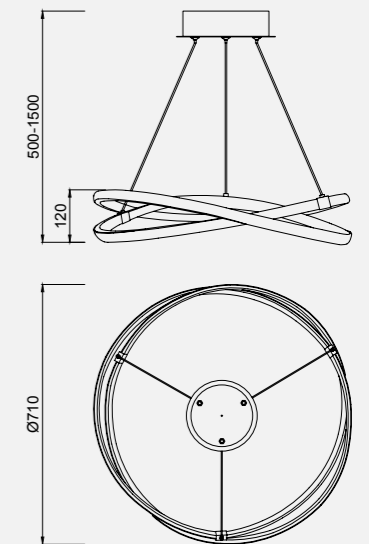
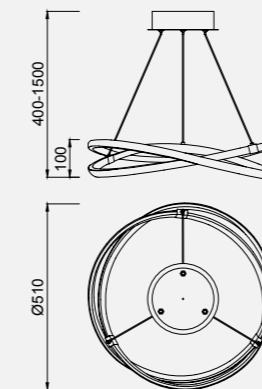
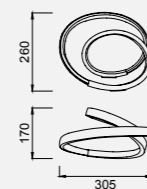

CRI >80 Aluminio / Acrílico / Acero - Aluminium / Acrylic / Steel



CRI >80 Aluminio / Acrílico / Acero - Aluminium / Acrylic / Steel







**Plafón - Ceiling Lamp**  
Forja - Brown oxide

**5392**  
LED 30W 2800K 2500 lm

**5812** Dimmable  
LED 30W 2800K 2500 lm

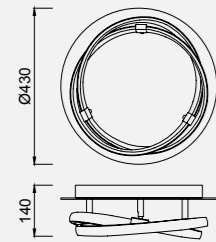

**Colgante - Pendant Lamp**  
Forja - Brown oxide

**5394**  
LED 30W 2800K 2500 lm

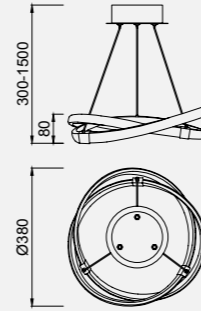
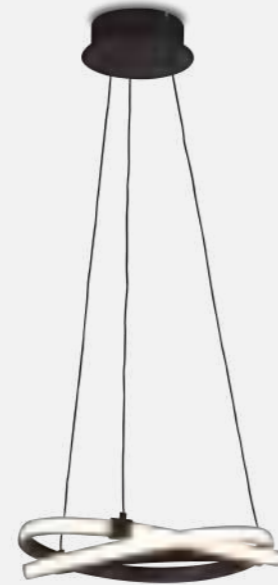

**Colgante - Pendant Lamp**  
Forja - Brown oxide

**5390**  
LED 42W 2800K 3400 lm

**5810** Dimmable  
LED 42W 2800K 3400 lm



**Colgante - Pendant Lamp**  
Forja - Brown oxide

**5391**  
LED 60W 2800K 4500 lm

**5811** Dimmable  
LED 60W 2800K 4500 lm



**Sobremesa - Table Lamp**  
Forja - Brown oxide

**5393**  
LED 12W 2800K 1000 lm  
Clase; II

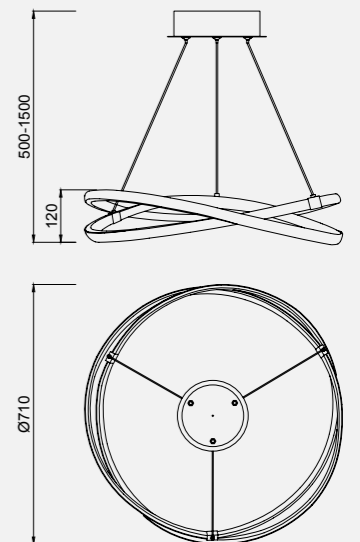
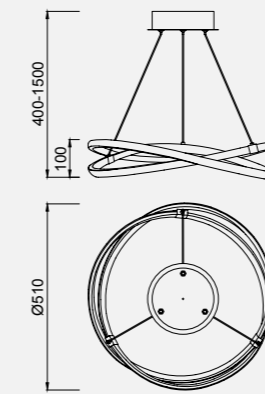
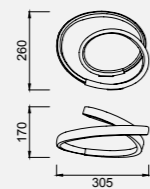

CRI >80 Aluminio / Acrílico / Acero - Aluminium / Acrylic / Steel



CRI >80 Aluminio / Acrílico / Acero - Aluminium / Acrylic / Steel



**Plafón - Ceiling Lamp**  
Blanco - White

**5992**  
LED 30W 2800K 2500 lm

**5992K**  
LED 30W 4000K 2500 lm



**Lámpara - Pendant Lamp**  
Blanco - White

**5993**  
LED 30W 2800K 2500 lm

**5993K**  
LED 30W 4000K 2500 lm

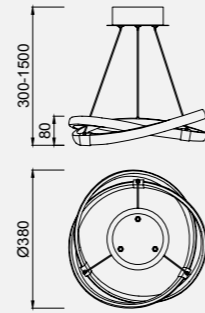
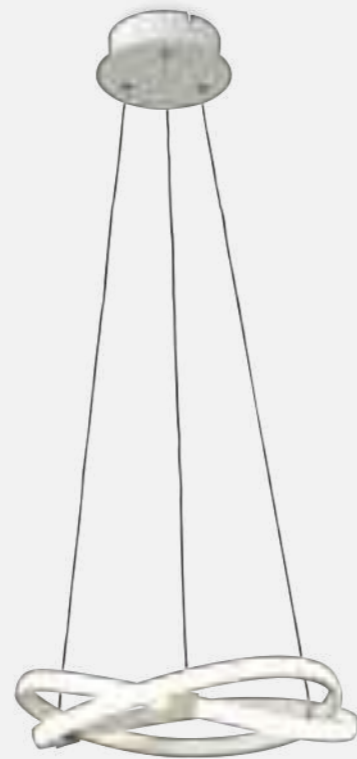

**Lámpara - Pendant Lamp**  
Blanco - White

**5990** Dimmable  
LED 42W 2800K 3400 lm



**5990K**  
LED 42W 4000K 3400 lm

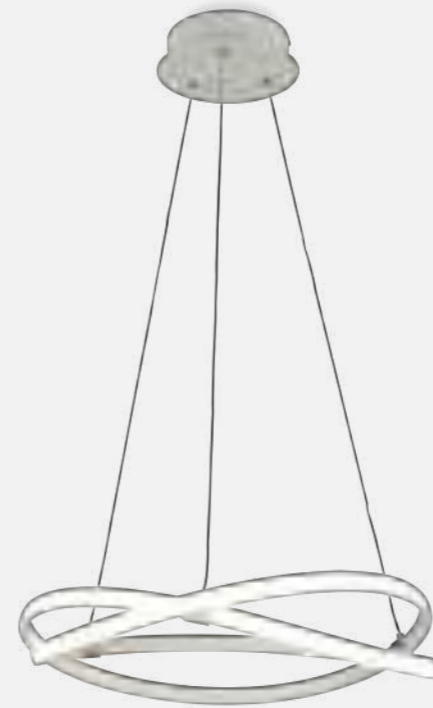

**Lámpara - Pendant Lamp**  
Blanco - White

**5991** Dimmable  
LED 60W 2800K 4500 lm



**5991K** Dimmable  
LED 60W 4000K 4500 lm



**Sobremesa - Table Lamp**  
Blanco - White

**5994**  
LED 12W 2800K 1000 lm

**5994K**  
LED 12W 4000K 1000 lm  
Clase II

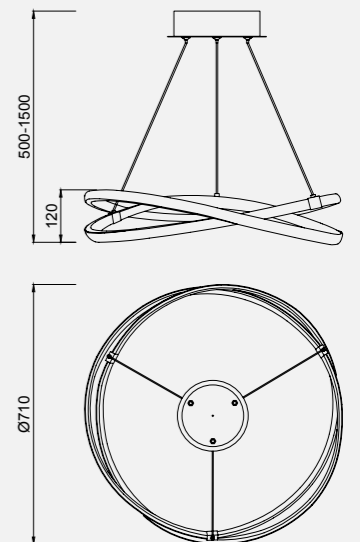
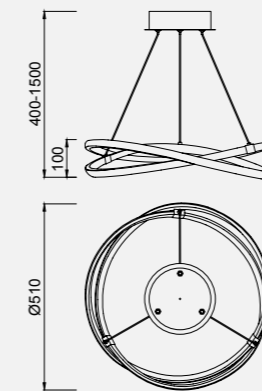
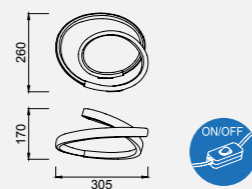

CRI >80 Aluminio / Acrílico / Acero - Aluminium / Acrylic / Steel



CRI >80 Aluminio / Acrílico / Acero - Aluminium / Acrylic / Steel

## KNOT LED

Mantra vuelve a beber de sus colecciones tipológicas, el giro y el movimiento alrededor del eje, en este caso dando pie a un juego minimalista y esencia donde solo la luz es el discurso de la estructura. KNOT LED es una lámpara de araña ligera, compuesta por curvas con un estilo particular y característico. Su tecnología LED permite a esta lámpara iluminar y embellecer cualquier ambiente. Atractiva y geométrica, al mismo tiempo matemática, así, en la disposición de sus brazos, da como resultado un producto arquitectónico en suspensión que permite el flujo de luz en la habitación.

*Mantra drinks again from their typological ranges, rotation and movement around an axis, in this case giving rise to a minimalist essence game where only light the address of the structure is. KNOT LED is a very light chandelier, marked by the curves chosen as a particular and characteristic style. Its LED technology allows this lamp to illuminate and embellish any environment. The attractive and geometrical, almost mathematical, way in which their arms are arranged, results in a symmetrical flying architectural product that lets light flow into the room.*

Santiago Sevillano

5916



OAMI 2745562/017 / 2745562/018 / 2745562/019 / 2745562/020  
ZL 201530163854.7 / 201530164011.9 / 201530163853.2 / 201530163895.6



# Knot led

**Plafón - Ceiling Lamp**  
Plata Cromo - Silver Chrome

**4989**  
LED 36W 3000K 2520 lm  
100-240V

**Plafón - Ceiling Lamp**  
Plata Cromo - Silver Chrome

**4994** Dimmable  
LED 36W 3000K 2520 lm  
220-240V

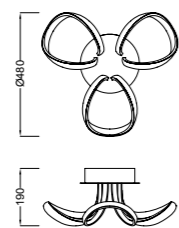

CRI >80 Aluminio / Acrílico / Acero - Aluminium / Acrylic / Steel



4989 -4994 -4988



**Plafón - Ceiling Lamp**  
Plata Cromo - Silver Chrome

**5916** Dimmable  
LED 60W 3000K 4800 lm

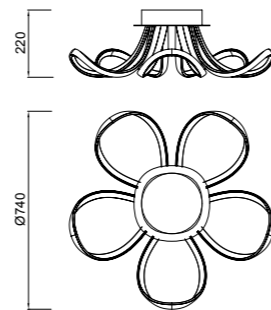

**Plafón - Ceiling Lamp**  
Plata Cromo - Silver Chrome

**4990**  
LED 40W 3000K 2800 lm  
100-240V~50/60Hz

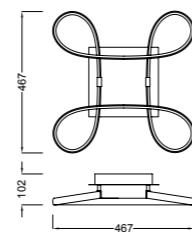

**Aplique - Wall Lamp**  
Plata Cromo - Silver Chrome

**4988**  
LED 12W 3000K 840 lm



**Aplique - Wall Lamp**  
Plata Cromo - Silver Chrome

**4993** Touch Dimmer  
LED 12W 3000K 840 lm

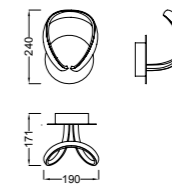



**Plafón - Ceiling Lamp**  
Blanco - White

**6035**  
LED 36W 2800K 2520 lm

**6035K**  
LED 36W 4000K 2520 lm

**Plafón - Ceiling Lamp**  
Blanco - White

**6036** Dimmable  
LED 36W 2800K 2520 lm

**6036K** Dimmable  
LED 36W 4000K 2520 lm

**Plafón - Ceiling Lamp**  
Blanco - White

**6037** Dimmable  
LED 60W 2800K 4800 lm

**Plafón - Ceiling Lamp**  
Blanco - White

**6037K** Dimmable  
LED 60W 4000K 4800 lm



220-240V~50/60Hz CRI >80 Aluminio / Acrílico / Acero - Aluminium / Acrylic / Steel



220-240V~50/60Hz CRI >80 Aluminio / Acrílico / Acero - Aluminium / Acrylic / Steel

# SÁHARA

SÁHARA XL, nueva opción propuesta para ampliar la colección con nuevas medidas que se adapten a distintas necesidades con el objetivo de abarcar mayor número de posibilidades aportando versatilidad a la colección. En este restyling se ha optado por ampliar las medidas de dos de las aplicaciones más importantes de la colección, la lámpara colgante y el pie de salón, al aumentar su tamaño también se ha mejorado su rendimiento, adquiriendo mayor potencia lumínica y mejor rendimiento con un mínimo consumo, la opción idónea para clientes que necesiten objetos de mayor tamaño y mejor rendimiento. Por otro lado se ha incorporado un nuevo acabado para abarcar otro tipo de ambientes decorativos, el acabado forja, opción que combina a la perfección con espacios decorativos más tradicionales, en los cuales predominen los tonos cálidos y los acabados naturales, una alternativa para ambientes de estilo rústico o contemporáneo, sin abandonar sus líneas modernas y vanguardistas que definen a la colección SÁHARA.

*SAHARA XL, new option to expand the collection with new measures that suit different needs in order to cover as many possibilities providing versatility to the collection. In this restyling has chosen to extend the measures of two of the most important applications of the collection, the pendant lamp and floor lamp, increasing its size also has improved the efficiency, gaining light and more power with minimum consume, the ideal choice for customers who need larger objects and better performance. On the other site it has a new finish to supply other types of decorative environments, "forja" finishing, it is a option that combines seamlessly with more traditional decorative spaces in which predominate warm tones and natural finishes, an alternative for rustic environments or contemporary style, without abandoning the modern and avant-garde lines that define the SAHARA collection.*

Hugo Tejada



4861



**Lámpara - Pendant Lamp**  
Plata Cromo - Silver Chrome

**4860**  
LED 36W 3000K 2520 lm

**4864** Dimmable  
LED 36W 3000K 2520 lm



**Lámpara - Pendant Lamp**  
Plata Cromo - Silver Chrome

**4865**  
LED 42W 3000K 3400 lm

**5815** Dimmable  
LED 42W 3000K 3400 lm

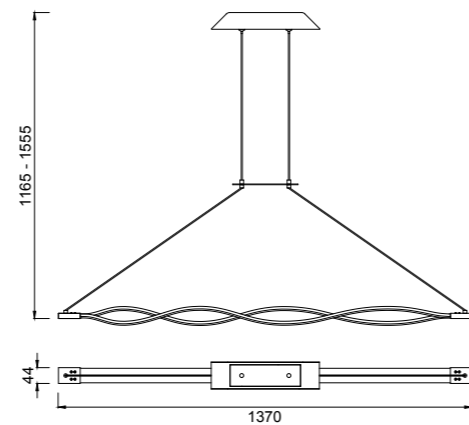
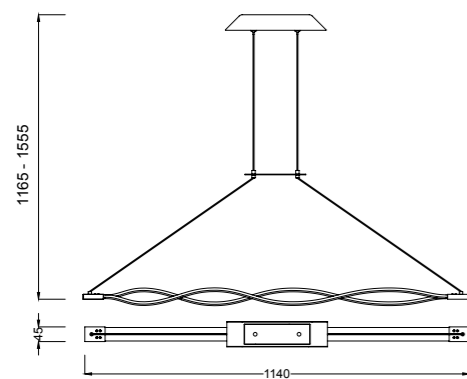
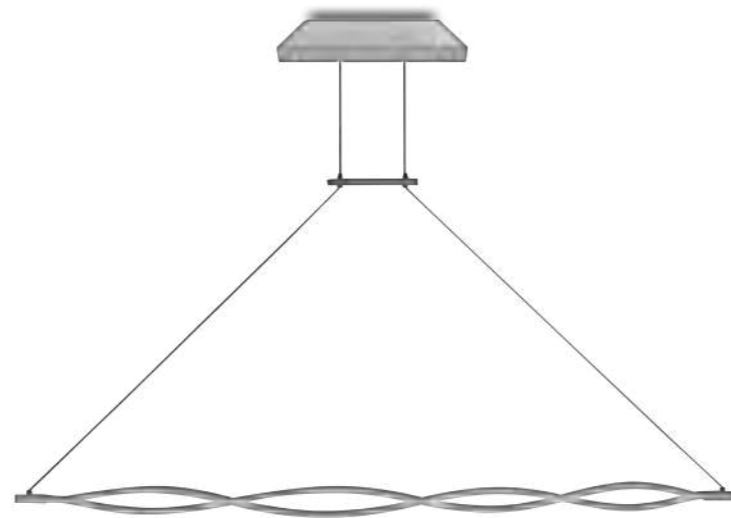

4865-5815

**Lámpara - Pendant Lamp**  
Forja - Brown oxide

**5400**  
LED 36W 3000K 2520 lm

**5817** Dimmable  
LED 36W 3000K 2520 lm 

**Lámpara - Pendant Lamp**  
Forja - Brown oxide

**5801**  
LED 42W 2800K 3400 lm

**5818** Dimmable  
LED 42W 2800K 3400 lm 

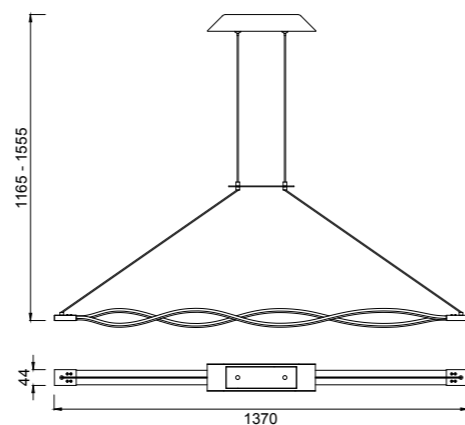
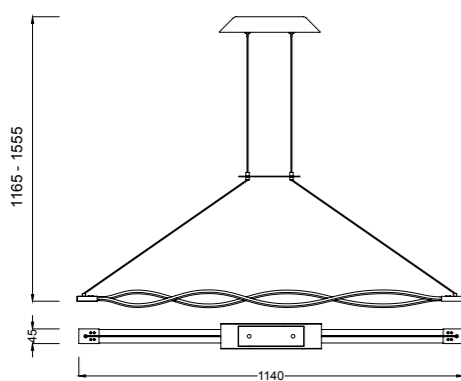



# Sáhara

**Pie De Salón - Floor Lamp**  
Plata Cromo - Silver Chrome

**4866** Dimmable  
LED 28W 3000K 2200 lm

**Pie De Salón - Floor Lamp**  
Forja - Brown oxide

**5802** Dimmable  
LED 28W 2800K 2200 lm

**Pie De Salón - Floor Lamp**  
Plata Cromo - Silver Chrome

**4861** Dimmable  
LED 20W 3000K 1470 lm

**Pie De Salón - Floor Lamp**  
Forja - Brown oxide

**5401** Dimmable  
LED 20W 2800K 1470 lm

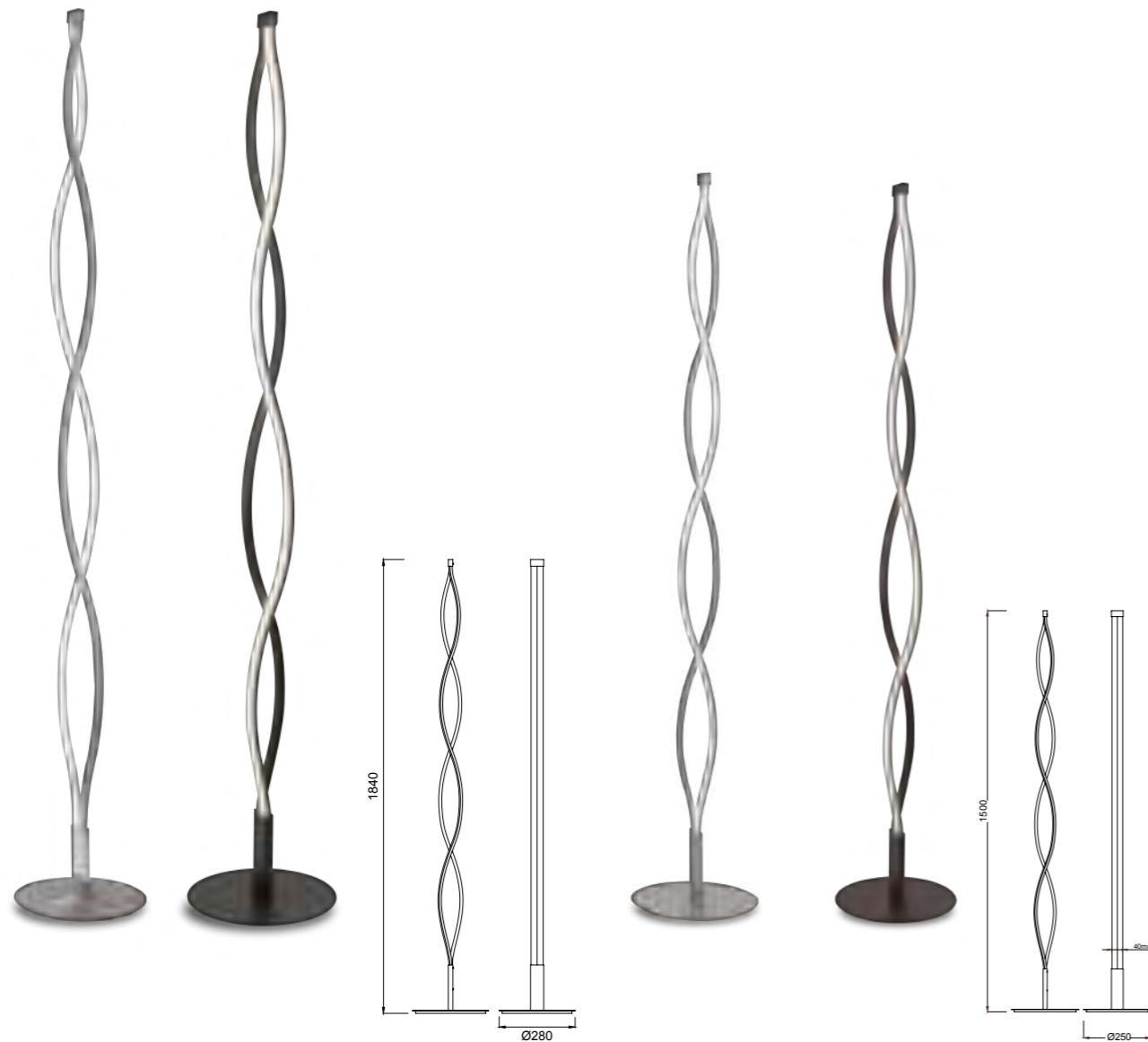

4866



**Aplique - Wall Lamp**  
Plata Cromo - Silver Chrome

**4863**  
LED 6W 3000K 420 lm  
100-240V

**4867 Touch Dimmer**  
LED 6W 3000K 420 lm  
120-240V

**Sobremesa - Table Lamp**  
Plata Cromo - Silver Chrome

**4862**  
LED 6W 3000K 420 lm  
220-240V~50/60Hz

**Sobremesa - Table Lamp**  
Plata Cromo - Brown oxide

**5402**  
LED 6W 2800K 420 lm  
220-240V

**Aplique - Wall Lamp**  
Plata Cromo - Brown oxide

**5403**  
LED 6W 2800K 420 lm  
100-240V

**5816 Touch Dimmer**  
LED 6W 2800K 420 lm  
120-240V

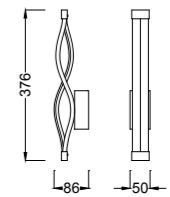
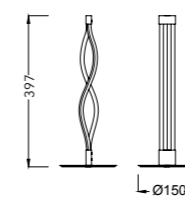
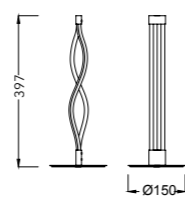
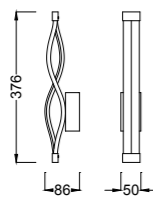

CRI >80 Aluminio / Acrílico / Acero - Aluminium / Acrylic / Steel



CRI >80 Aluminio / Acrílico / Acero - Aluminium / Acrylic / Steel



## AIRE&STAR LED

El perfil formal de Aire&Star está basado en la clásica manufactura del trenzado de cestos y la estructura que dibuja el perfil de los molinos de viento. Aspectos que aunados otorgan a Aire su característica estética quijotesca, sencilla a la par que espléndida. Líneas de inspiración arquitectónica, entrelazadas en el espacio de manera libre y abierta, alrededor de un eje central. Un conjunto de líneas aleatorias que aportan a la Aire&Star su característico dinamismo y ligereza visual.

*The formal profile of "Aire&Star" is based on the basic manufacturing of baskets' braiding with an structure that draws the profile of windmills. Aspects which united, contribute to Aire's characteristic Quixotesque aesthetics, simple as well as splendid. Architecture-inspired lines, openly intertwined in space, evolving into a central axis. A complex of random lines that provide its characteristic dynamism and visual lightness.*

Santiago Sevillano



5910

OAMI 002987966-0006 - 0007

**Lámpara - Pendant Lamp**  
Plata Cromo - Silver Chrome

**5910**  
LED 60W 3000K 4800 lm  
Dimmable

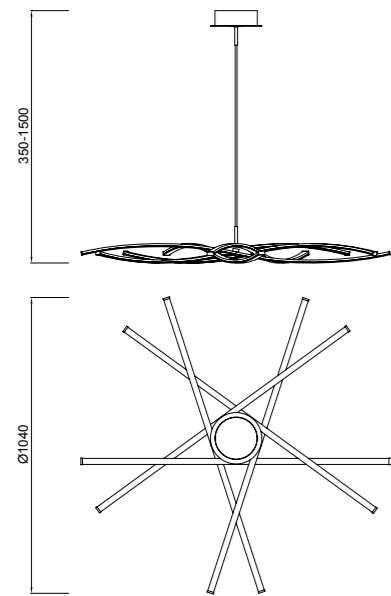

220-240V- 50/60Hz CRI >80 Aluminio / Acero / Acrílico - Aluminium / Steel / Acrylic





**Lámpara - Pendant Lamp**  
Plata Cromo - Silver Chrome

**5912**  
LED 42W 3000K 3700 lm  
Dimmable



**Lámpara - Pendant Lamp**  
Plata Cromo - Silver Chrome

**5914**  
LED 42W 3000K 3700 lm

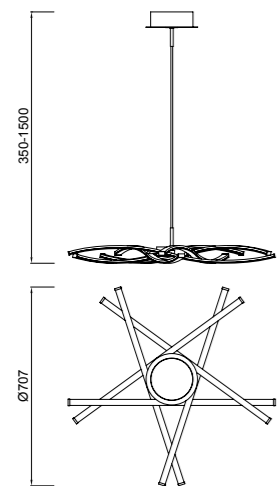

**Plafón - Ceiling Lamp**  
Plata Cromo - Silver Chrome

**5917**  
LED 42W 3000K 3700 lm  
Dimmable



**Plafón - Ceiling Lamp**  
Plata Cromo - Silver Chrome

**6030**  
LED 42W 3000K 3700 lm

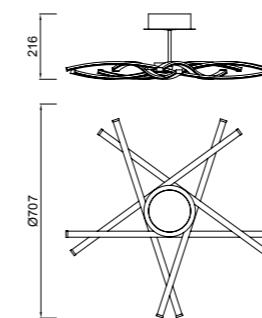

220-240V~50/60Hz CRI>80 Aluminio / Acero / Acrílico - Aluminium / Steel / Acrylic



220-240V~50/60Hz CRI>80 Aluminio / Acero / Acrílico - Aluminium / Steel / Acrylic



# Star Led

Lámpara - Pendant Lamp  
Plata Cromo - Silver Chrome

5911  
LED 60W 3000K 4800 lm  
Dimmable

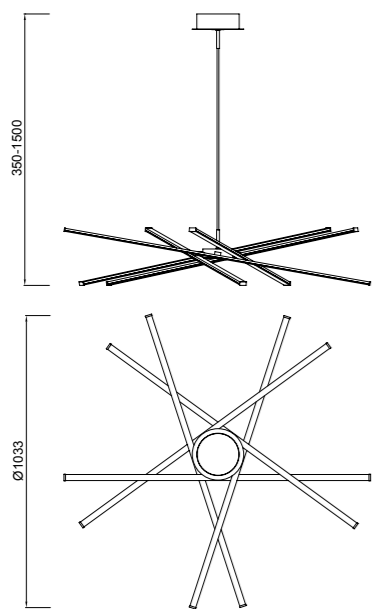

220-240V~50/60Hz CRI >80 Aluminio / Acero / Acrílico - Aluminium / Steel / Acrylic





**Lámpara - Pendant Lamp**  
Plata Cromo - Silver Chrome

**5913**  
LED 42W 3000K 3700 lm  
Dimmable

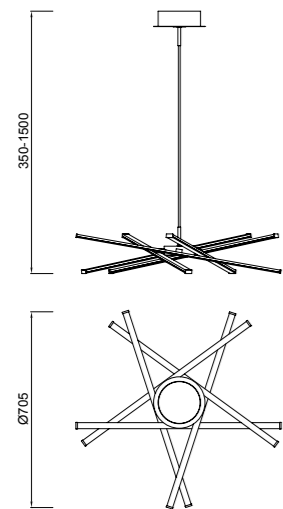

**Lámpara - Pendant Lamp**  
Plata Cromo - Silver Chrome

**5915**  
LED 42W 3000K 3700 lm

**Plafón - Ceiling Lamp**  
Plata Cromo - Silver Chrome

**5918**  
LED 42W 3000K 3700 lm  
Dimmable

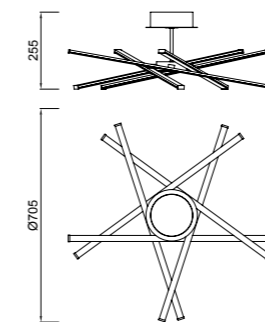

**Plafón - Ceiling Lamp**  
Plata Cromo - Silver Chrome

**6031**  
LED 42W 3000K 3700 lm



220-240V~50/60Hz CRI >80 Aluminio / Acero / Acrílico - Aluminium / Steel / Acrylic



220-240V~50/60Hz CRI >80 Aluminio / Acero / Acrílico - Aluminium / Steel / Acrylic



# BUCLE

La mínima expresión materializada en un objeto de decoración, esta sería la definición más concisa que definiría la colección *Bucle*. El concepto se basa en la continuidad de la luz, en crear una sensación de luz continua a lo largo de un volumen lineal, limpio y puro, un objeto aparentemente sencillo pero a la vez complejo. La colección incorpora luz Led de alto rendimiento que permite una difusión de luz mágica y amigable. *Bucle* está compuesta por diferentes aplicaciones que permiten decorar la estancia con el mismo estilo, una colección polivalente de carácter decorativo, el efecto de luz como protagonista sin elementos superfluos, una línea de luz continua que iluminará la estancia con la mínima expresión.

*The minimal expression materialized in an object of decoration, this would be the more concise definition that would define the collection BUCLE. The concept is based on the continuity of light, creating a sense of continuous light along a linear, clean and pure volume, an object apparently simple but at the same time complex. The collection incorporates high performance LED light that allows a magical and friendly light diffusion. BUCLE is composed by different applications that allow to decorate the stay with the same style, a multipurpose collection of decorative character, the effect of light as protagonist without superfluous elements, a continuous line of light that will illuminate the stay with the least expression.*

Hugo Tejada



5987

OAMI 004022663-0001



**Colgante - Pendant Lamp**  
Plata Cromo - Silver Chrome

**5870**  
LED 42W 3000K 3650 lm

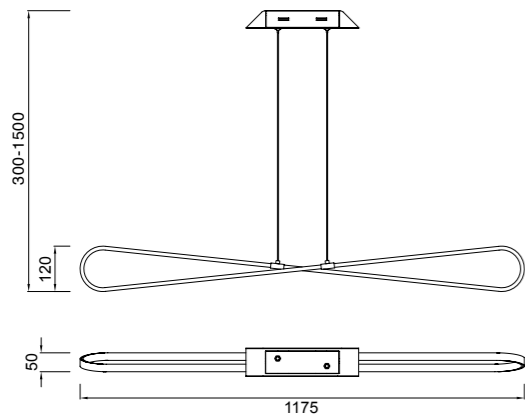

**Aplique - Wall Lamp**

Plata Cromo - Silver Chrome

**5983**

LED 20W 3000K 1750 lm

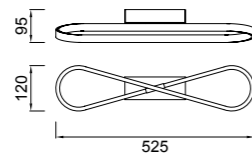

100-240V~50/60Hz CRI>80 Acero / Acrílico - Steel / Acrylic



**Plafón - Ceiling lamp**

Plata Cromo - Silver Chrome

**5981**

LED 36W 3000K 3150 lm

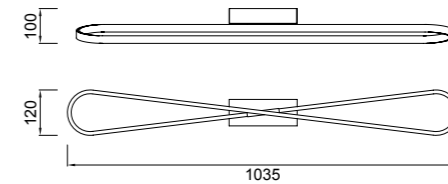

220-240V~50/60Hz CRI>80 Acero / Acrílico - Steel / Acrylic





Bucle

Plafón - Ceiling Lamp  
Plata Cromo - Silver Chrome

5982  
LED 40W 3000K 3500 lm

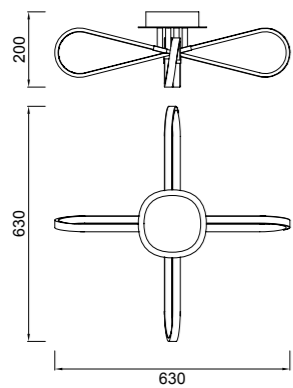

100-240V~50/60Hz CRI>80 Acero / Acrílico - Steel / Acrylic



Bucle



5987



**Pie De Sal3n - Floor Lamp**  
Plata Cromo - Silver Chrome

**5987**  
LED 50W 3000K 4300 lm  
Dimmable

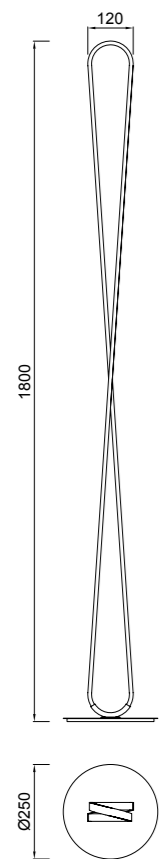

**Sobremesa - Table Lamp**  
Plata Cromo - Silver Chrome

**5984**  
LED 18W 3000K 1550 lm

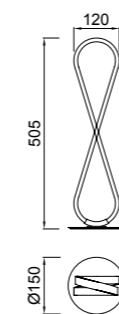

220-240V~50/60Hz CRI>80 Acero/Acrilico - Steel/Acrylic



100-240V~50/60Hz CRI>80 Aluminio/Acero/Acrilico - Aluminium/Steel/Acrylic



## HEMISFÈRIC

Colección de estilo minimalista, un efecto de luz lineal aplicado a un objeto iluminado. Hemisfèric es un atrevimiento técnico, una escultura luminosa con forma de arco, un objeto en suspensión que genera una sensación mágica. Está fabricada en aluminio anodizado y acrílico de alta calidad. La colección está compuesta por diferentes aplicaciones, diseñada para ambientes vanguardistas e instalaciones, se trata de un producto versátil desarrollado para perdurar en el tiempo y disfrutar de su efecto lumínico que es capaz de transformar cualquier tipo de espacio en un ambiente íntimo y acogedor.

*Minimalist collection of lamps, linear light effect applied to an object illuminated. Hemisfèric is a technical audacity, a bright arc-shaped sculpture, suspending object that generates a feeling magic. It is made of anodized aluminum and high quality acrylic. The collection consists of different applications, designed for modern environments and premises, it is a versatile product developed to endure over time and enjoy their lighting effect that can transform any space in an intimate setting and friendly space.*

Hugo Tejada



OAMI 002381905-0006/0007/ZL20133058664.0



# Hemisfèric

## Lámpara - Pendant Lamp Aluminio - Aluminium

**4080**  
LED 28W 3000K 2520 lm  
220-240V~50Hz

## Lámpara - Pendant Lamp Aluminio - Aluminium

**4081**  
LED 20W 3000K 1800 lm  
100-240V~50/60Hz

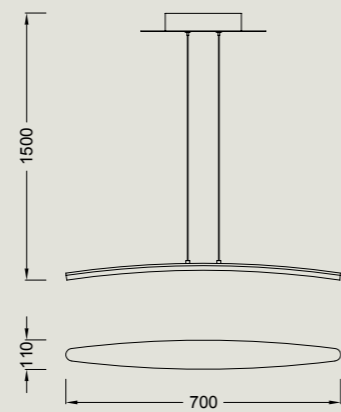
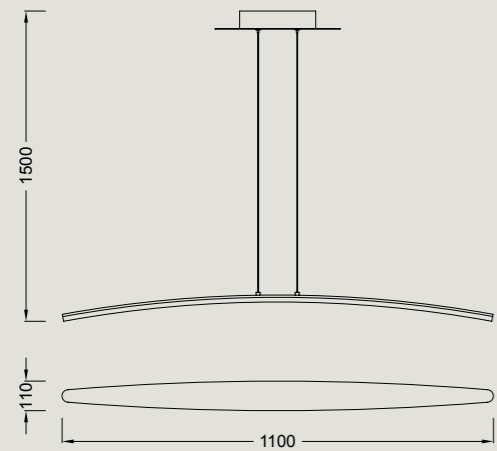
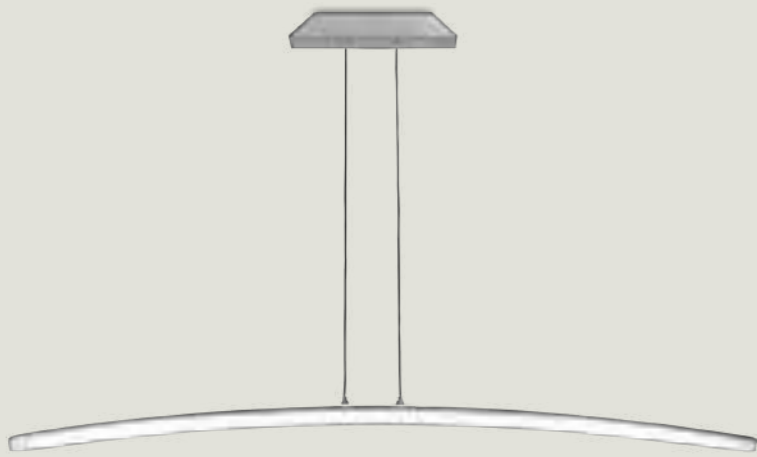

CRI >80 Aluminio / Acrílico - Aluminium / Acrylic





**Plafón - Ceiling Lamp**  
Aluminio - Aluminium

**4083**  
LED 20W3000K 1800 lm

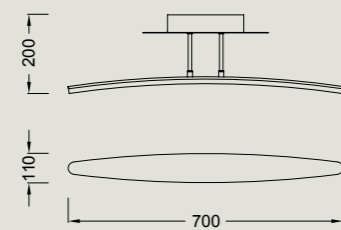

**Aplique - Wall Lamp**  
Aluminio - Aluminium

**4084**  
LED 6W3000K 540 lm  
100-240V~ 50/60Hz

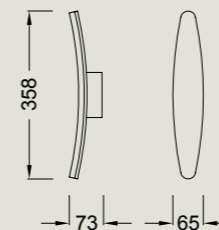

**Sobremesa - Table Lamp**  
Aluminio - Aluminium

**4085**  
LED 6W3000K 540 lm

**Pie De Salón - Floor Lamp**  
Aluminio - Aluminium

**4086** Dimmable  
LED 20W3000K 1800 lm

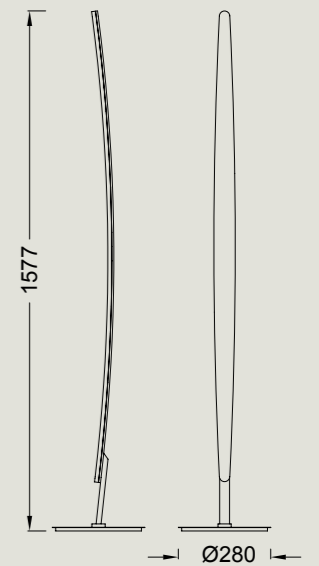
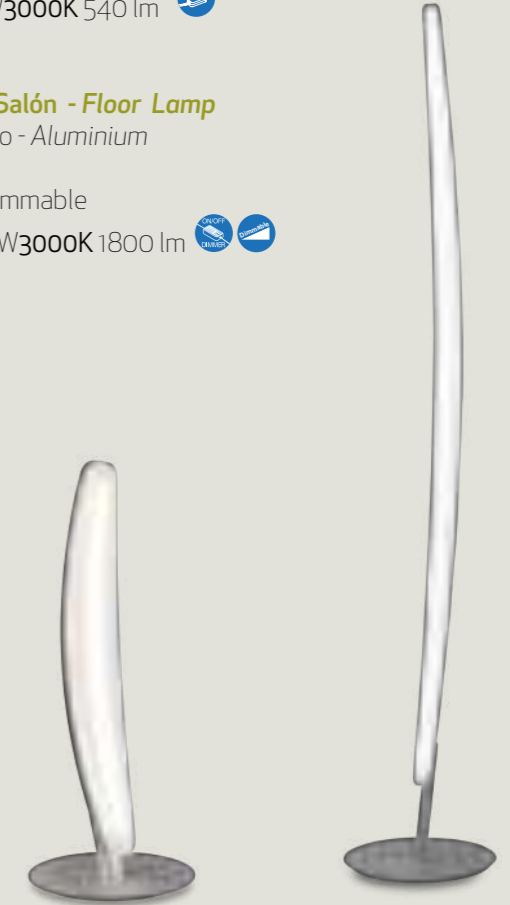

100-240V~ 50/60Hz CRI>80 Aluminio / Acrílico - Aluminium / Acrylic



220-240V~ 50/60Hz CRI>80 Aluminio / Acrílico - Aluminium / Acrylic



# Adn

Una distribución anárquica de puntos de luz conforman las estructuras de ADN, con equilibrio estético y visual. La colección de led ilumina de forma potente y presenta una gran variedad de elementos en diversos formatos.

Como característica principal sus armazones, decorados en blanco epoxi, aporta la posibilidad de reemplazar sus puntos de led, si ocasionalmente fuera necesario. "ADN" distinta, diferente y original, destinada a vestir e iluminar tu espacio favorito.

*An anarchic distribution of lighting points conform the structures of DNA, with an artistic and visual balance. This LED collection illuminates in a powerful way and presents a wide variety of elements in different formats. As a main characteristic, its frames, decorated in white epoxy, provide the possibility of replacing its LED points, if necessary. "ADN" is a different and original piece, destined to dress and illuminate your favorite space.*

Mantra Team



6260

OAMI004721413-028



**Lámpara - Pendant Lamp**  
Blanco mate - Matte white

**6262**  
LED 36W 3000K -1980 lm

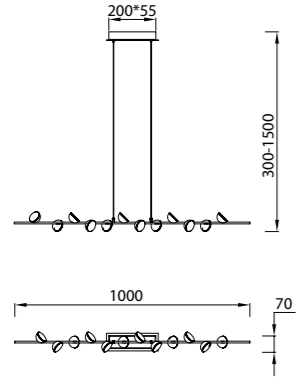

**6260**  
LED 100W 3000K -5500 lm

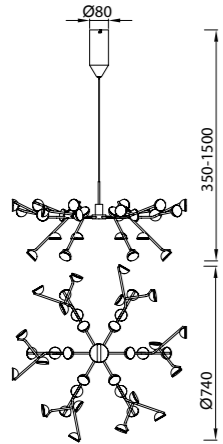

**6261**  
LED 72W 3000K -3960 lm

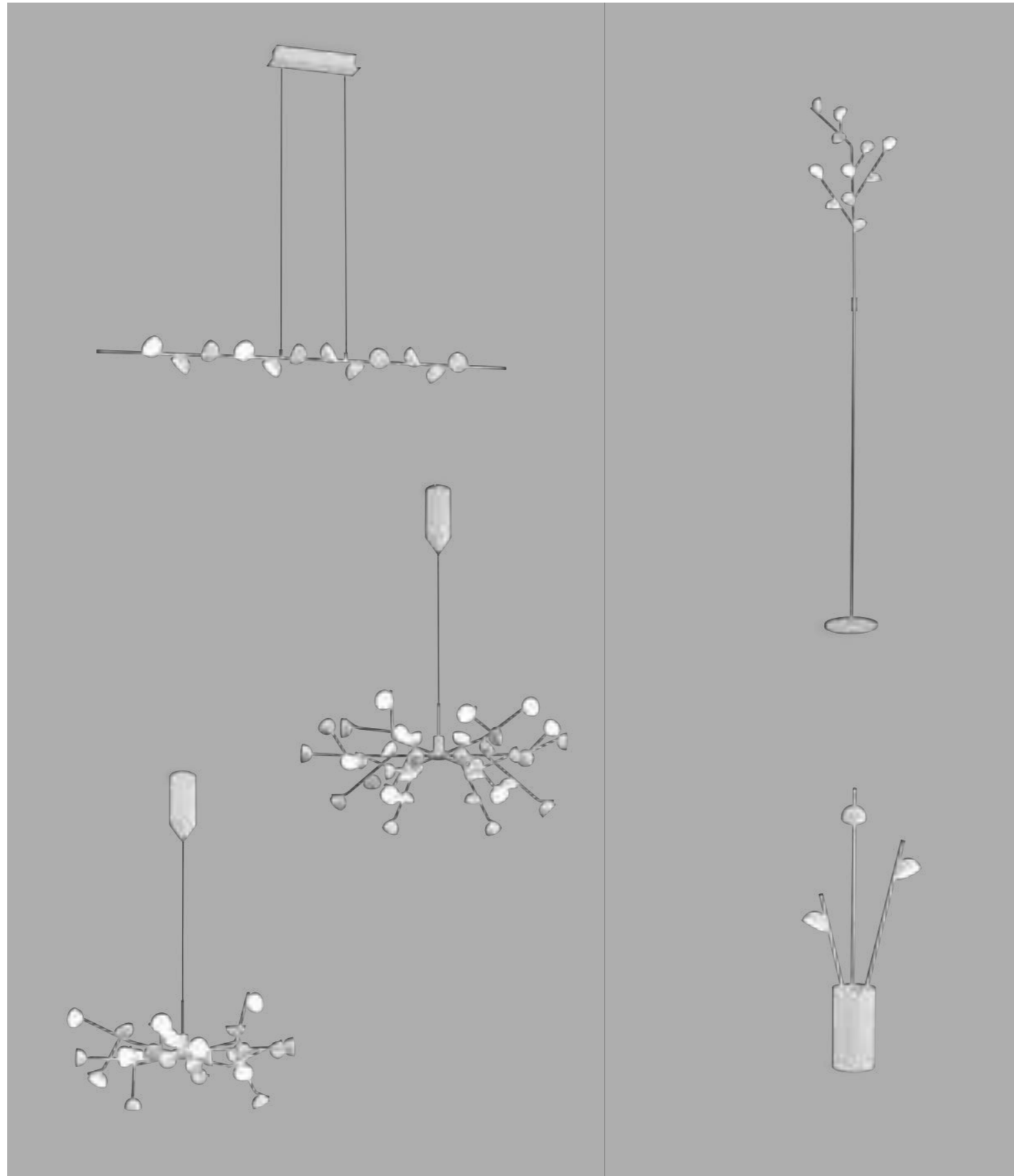
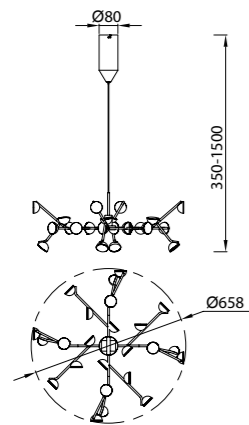

**Pie De Salón - Floor Lamp**  
Blanco mate - Matte white

**6268**  
LED 30W 3000K -1650 lm

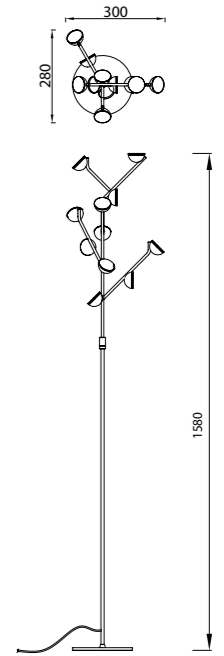

**Sobremesa - Table Lamp**  
Blanco mate - Matte white

**6267**  
LED 9W 3000K -495 lm

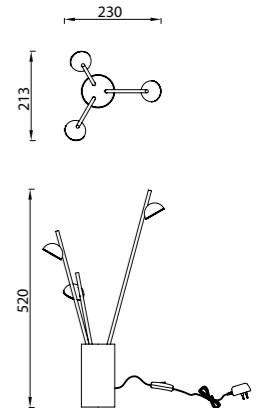

220-240V-50/60Hz CRI>80 Aluminio - Aluminium



220-240V-50/60Hz CRI>80 Aluminio - Aluminium



**Aplique - Wall Lamp**  
Blanco mate - Matte white

**6263**  
LED 48W 3000K -2640 lm

**Aplique - Wall Lamp**  
Blanco mate - Matte white

**6264**  
LED 24W 3000K -1320 lm

**Aplique - Wall Lamp**  
Blanco mate - Matte white

**6265**  
LED 6W 3000K -330 lm

**Aplique - Wall Lamp**  
Blanco mate - Matte white

**6266**  
LED 3W 3000K -165 lm

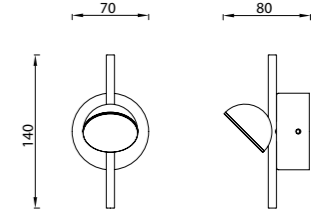
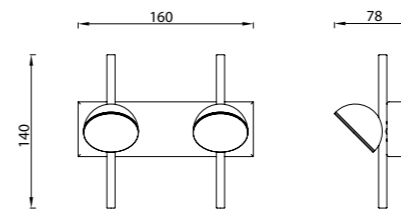
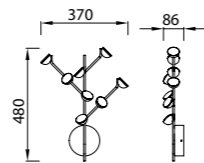
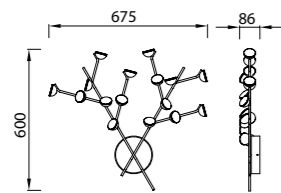
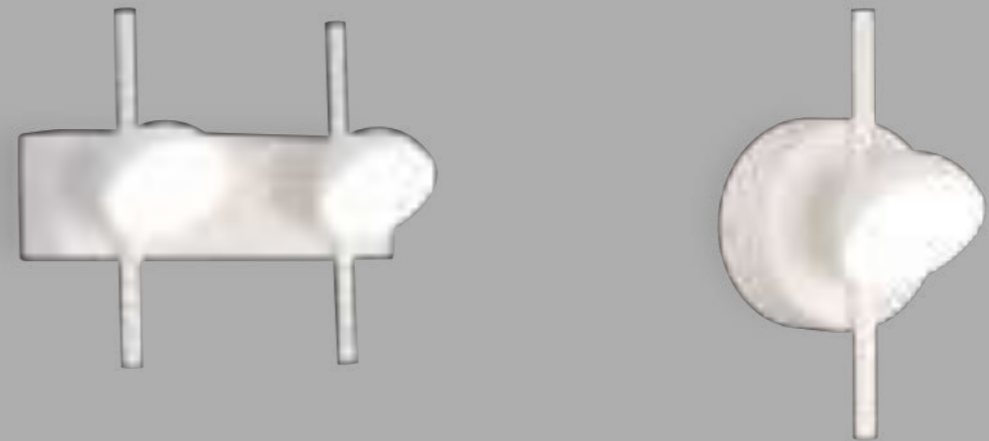
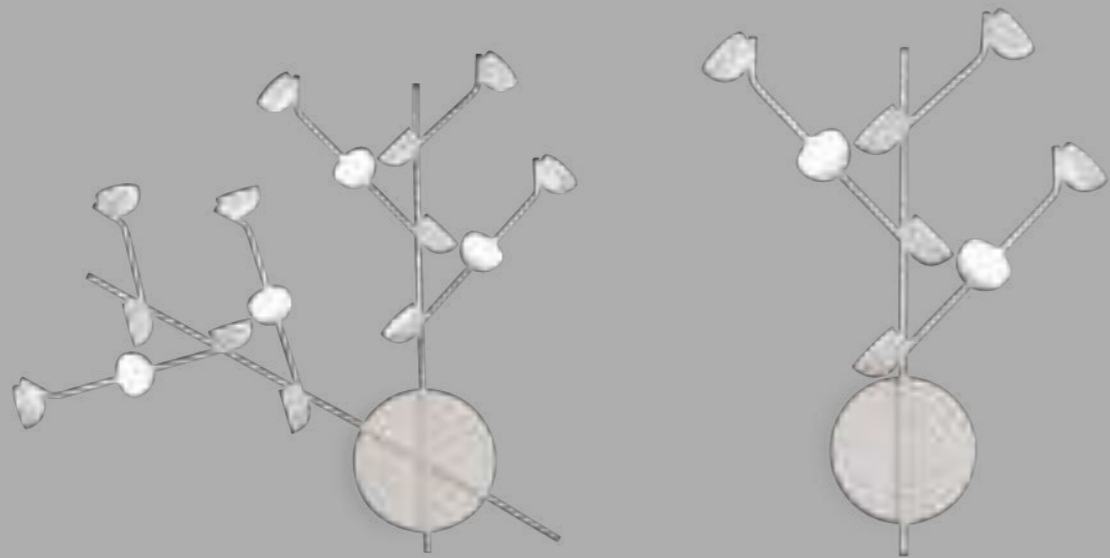

220-240V-50/60Hz CRI>80 Aluminio - Aluminium



100-250V-50/60Hz CRI>80 Aluminio - Aluminium



**Plafón - Ceiling Lamp**  
Blanco mate - Matte white

**6415**  
LED 100W 3000K -5500 lm

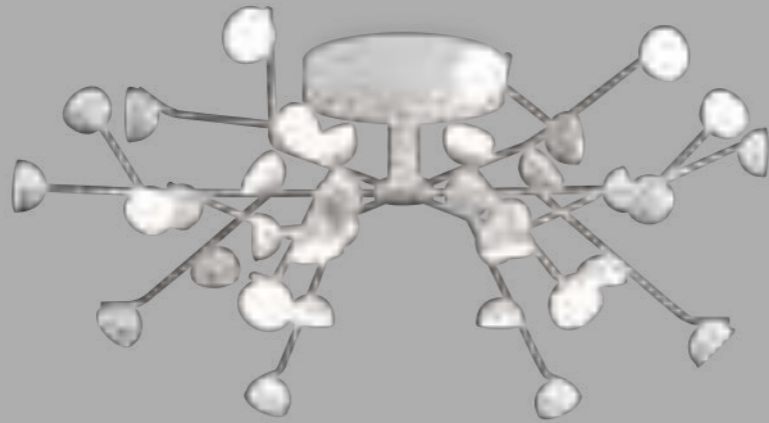

**Plafón - Ceiling Lamp**  
Blanco mate - Matte white

**6416**  
LED 72W 3000K -3960 lm

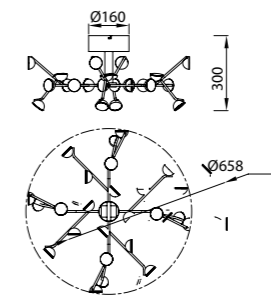
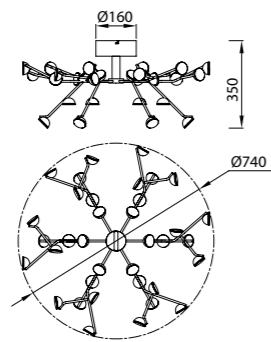
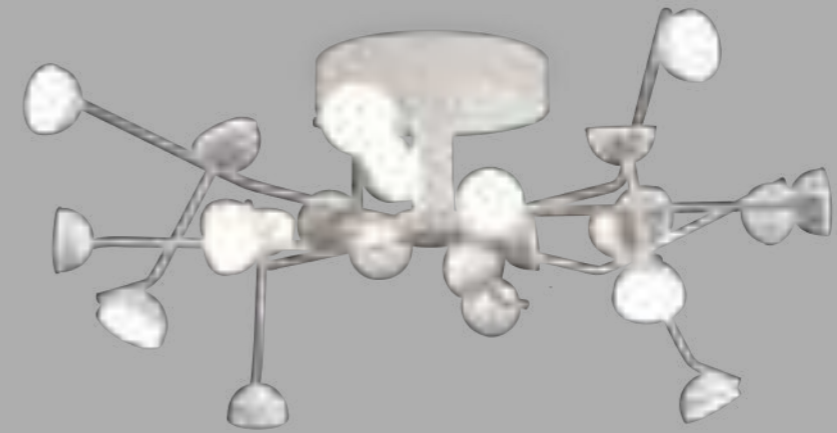

220-240V-50/60Hz CRI>80 Aluminio - Aluminium



100-250V-50/60Hz CRI>80 Aluminio - Aluminium



Orbital

**Colgante - Pendant Lamp**  
Blanco - White

**5740**  
LED 130W 3000K 4250 lm  
Dimmable



**Colgante - Pendant Lamp**  
Blanco - White

**5741**  
LED 90W 3000K 3250 lm  
Dimmable



**Colgante - Pendant Lamp**  
Blanco - White

**5742**  
LED 54W 3000K 2000 lm  
Dimmable

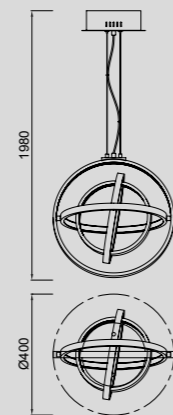
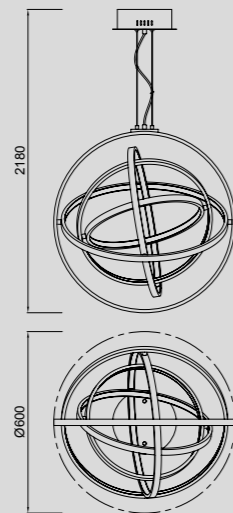
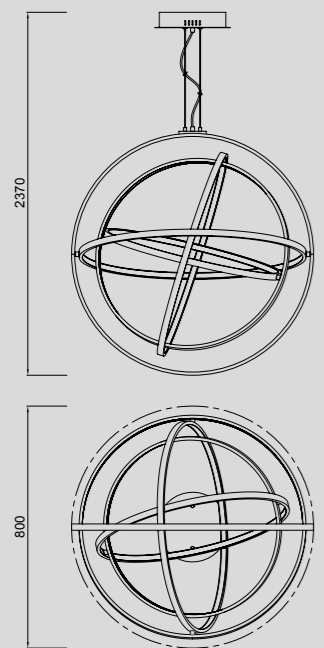
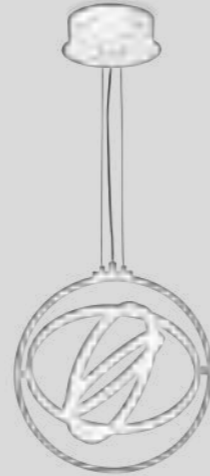

220-240V-50/60Hz CRI >80 Aluminio / Acrílico / Acero - Aluminium / Acrylic / Steel OAMI 003854025-0001

5740

ORBITAL



OAMI 003854025-0001



Orbital

**Plafón - Ceiling Lamp**  
Blanco - White

**5746**  
LED 40W 3000K 1510 lm



**Sobremesa - Table Lamp**  
Blanco - White

**5747**  
LED 12W 3000K 660 lm  
Clase: II

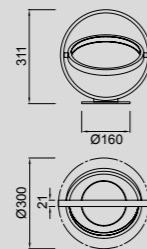
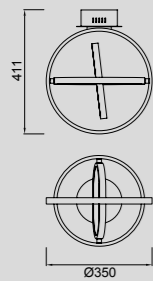
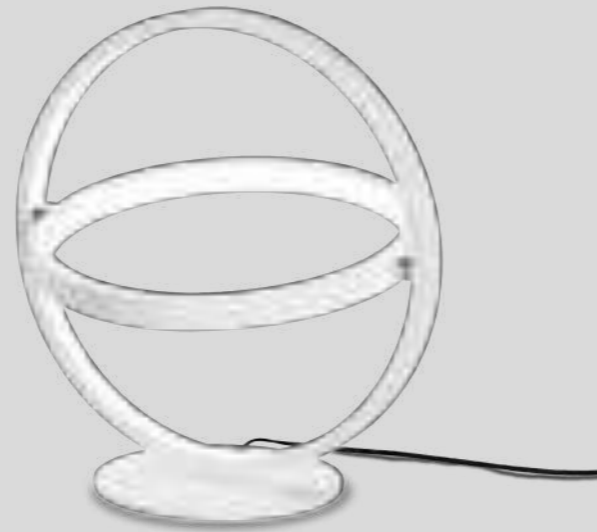

220-240V- 50/60Hz CRI >80 Aluminio / Acrílico / Acero - Aluminium / Acrylic / Steel OAMI 003854025-0001

5740



OAMI 003854025-0001



**Colgante - Pendant Lamp**  
Blanco mate - Matte White

**5760**  
LED 76W 3000K 3700 lm  
Dimmable



**Colgante - Pendant Lamp**  
Blanco mate - Matte White

**5761**  
LED 54W 3000K 2830 lm  
Dimmable



**Colgante - Pendant Lamp**  
Blanco mate - Matte White

**5762**  
LED 43W 3000K 2120 lm  
Dimmable

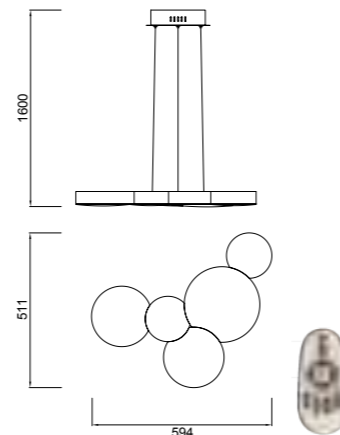
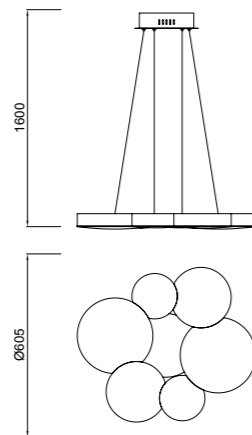
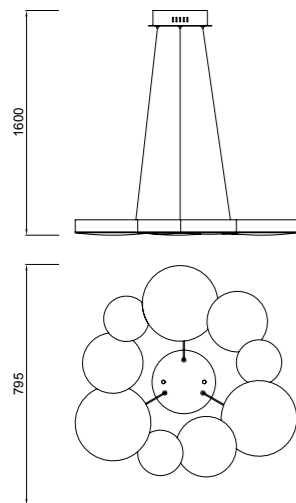

220-240V-50/60Hz CRI>80 ABS / Acero - ABS/Steel OAMI 003854025-0003

5760

LUNAS



OAMI 003854025-0003



Plafón - Ceiling Lamp  
Blanco mate - Matte White

5764  
LED 54W 3000K 2830lm  
Dimmable

Plafón - Ceiling Lamp  
Blanco mate - Matte White

5768  
LED 43W 3000K 2120lm  
Dimmable

Plafón - Ceiling Lamp  
Blanco mate - Matte White

5766  
LED 27W 3000K 1430lm

Plafón - Ceiling Lamp  
Blanco mate - Matte White

5767  
LED 14W 3000K 720lm

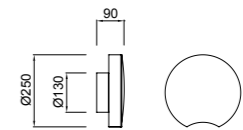
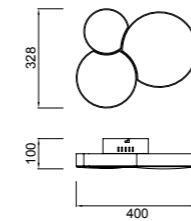
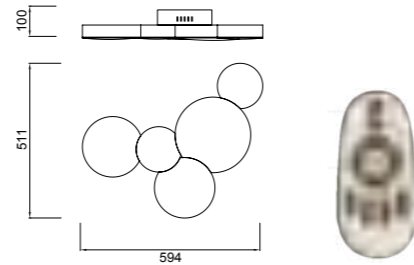
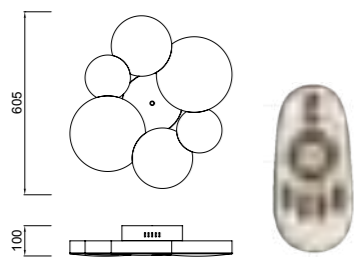

220-240V~50/60Hz CRI>80 ABS / Acero - ABS / Steel OAMI 003854025-0003



220-240V~50/60Hz CRI>80 ABS / Acero - ABS / Steel OAMI 003854025-0003

## INDUSTRIAL

Revisando la estética industrial, se recuperan materiales y formas de construcción propias de otra época, que junto a acabados envejecidos dan como resultado diseños atemporales con aire retro. Se produce un *Déjà vu* donde el inconsciente del pasado enriquece nuestro presente. Las cinchas de tela que sirven para colgar las lámparas proporcionan un toque cálido, que dulcifica el elemento industrial y da la idea de terminado a mano, de manufactura, casi de producto de recuperación, como si fuese reciclado. En estos momentos, superado el minimalismo, nos rodeamos de objetos que nos cuenten una historia, que nos aporten experiencia y nos acompañen en el futuro.

*Reviewing the industrial aesthetic, recovering materials and ways of another era, combined with aging finishes, result in timeless designs with retro flavour. It produces a "déjà vu" where the unconscious of the past enriches our present. Fabric straps used to hang the lamps, provide a warm touch that softens the industrial component and gives the idea of hand made, recovery product, almost as if it were recycled. Right now surpassed minimalism, we surround ourselves with objects that tell us a story, that bring us experience and join us in the future.*

Santolaria&Llusà

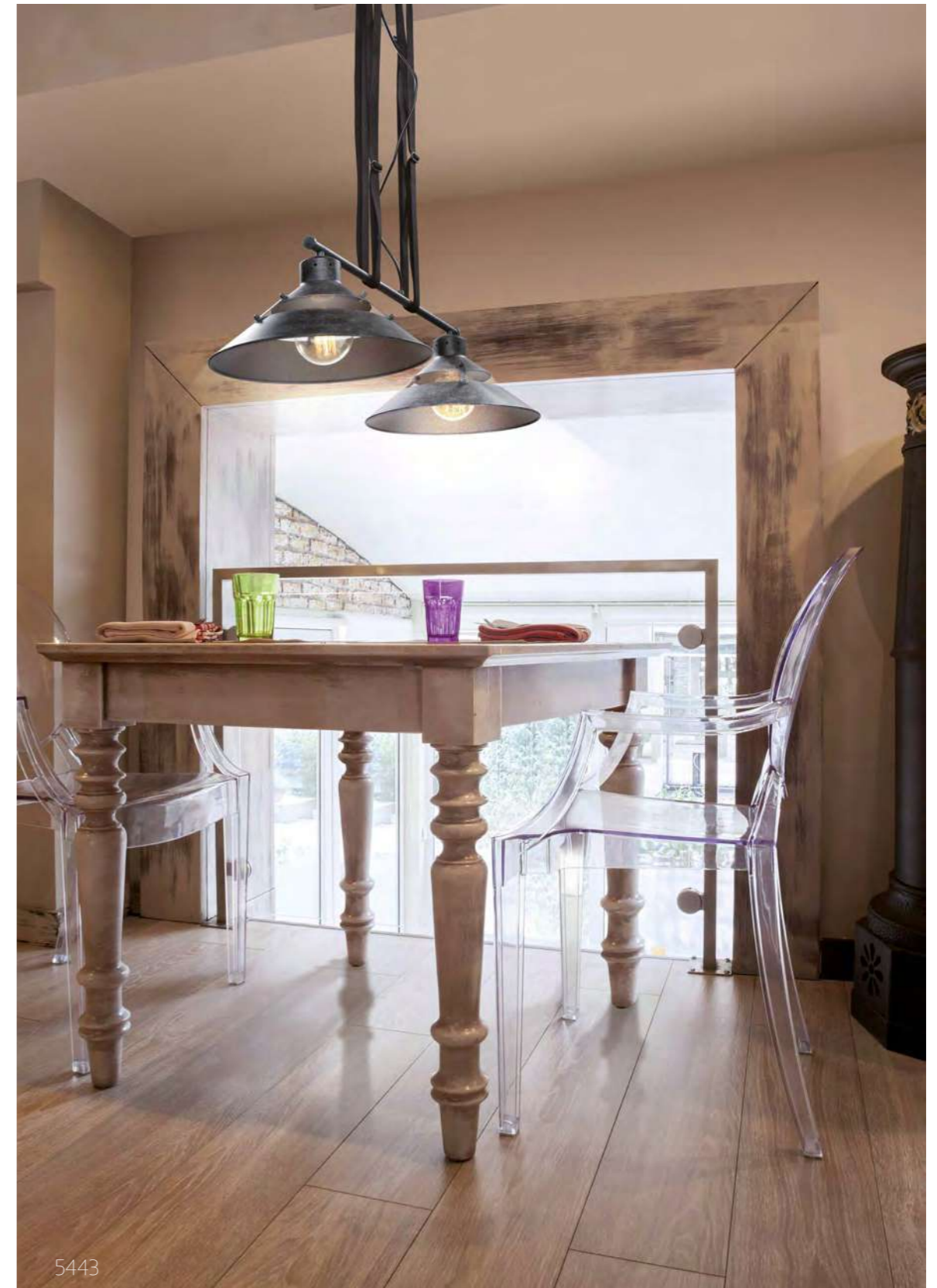

5443



Lámpara - Pendant Lamp  
Blanco - Sand Metal

5433  
2x E27 máx.40W/no incl

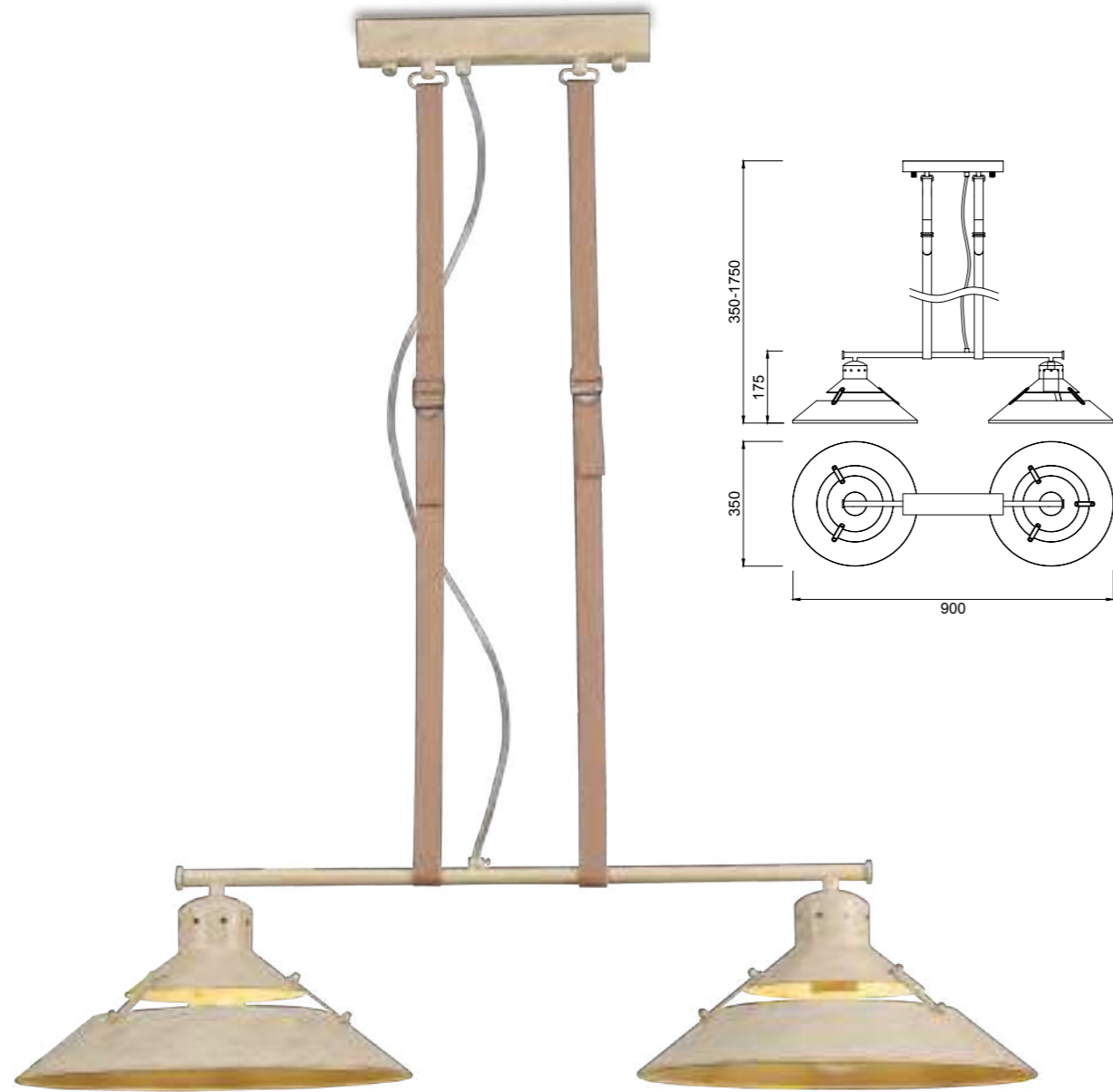

Lámpara - Pendant Lamp  
Metal óxido - Oxide Metal

5443  
2x E27 máx.40W/no incl



220-240V- 50/60Hz Tela / Acero - Fabric / Steel



220-240V- 50/60Hz Tela / Acero - Fabric / Steel



**Colgante - Pendant Lamp**

Metal Grafito - Graphite Metal  
**5440**  
 1x E27 máx.40W/no incl

Metal Arena - Sand Metal  
**5430**  
 1x E27 máx.40W/no incl

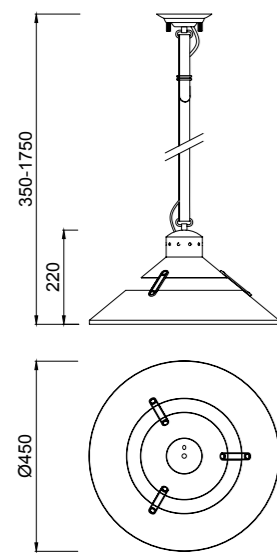

**Colgante - Pendant Lamp**

Metal Grafito - Graphite Metal  
**5441**  
 1x E27 máx.40W/no incl

Metal Arena - Sand Metal  
**5431**  
 1x E27 máx.40W/no incl

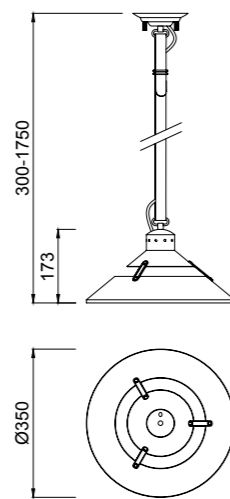

**Colgante - Pendant Lamp**

Metal Grafito - Graphite Metal  
**5442**  
 1x E27 máx.40W/no incl

Metal Arena - Sand Metal  
**5432**  
 1x E27 máx.40W/no incl

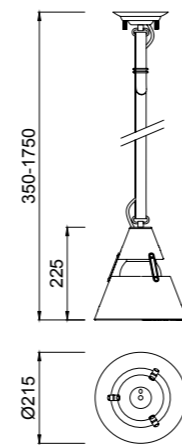

220-240V- 50/60Hz Tela / Acero - Fabric / Steel





**Aplique - Wall Lamp**  
Metal Arena - Sand Metal

**5434**  
1x E27 máx.40W/no incl

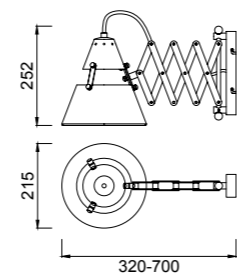

220-240V- 50/60Hz Acero - Steel



**Aplique - Wall Lamp**  
Metal Grafito - Graphite Metal

**5444**  
1x E27 máx.40W/no incl

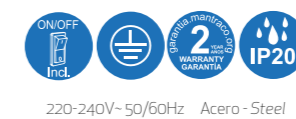
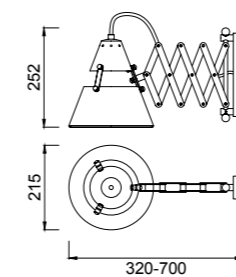
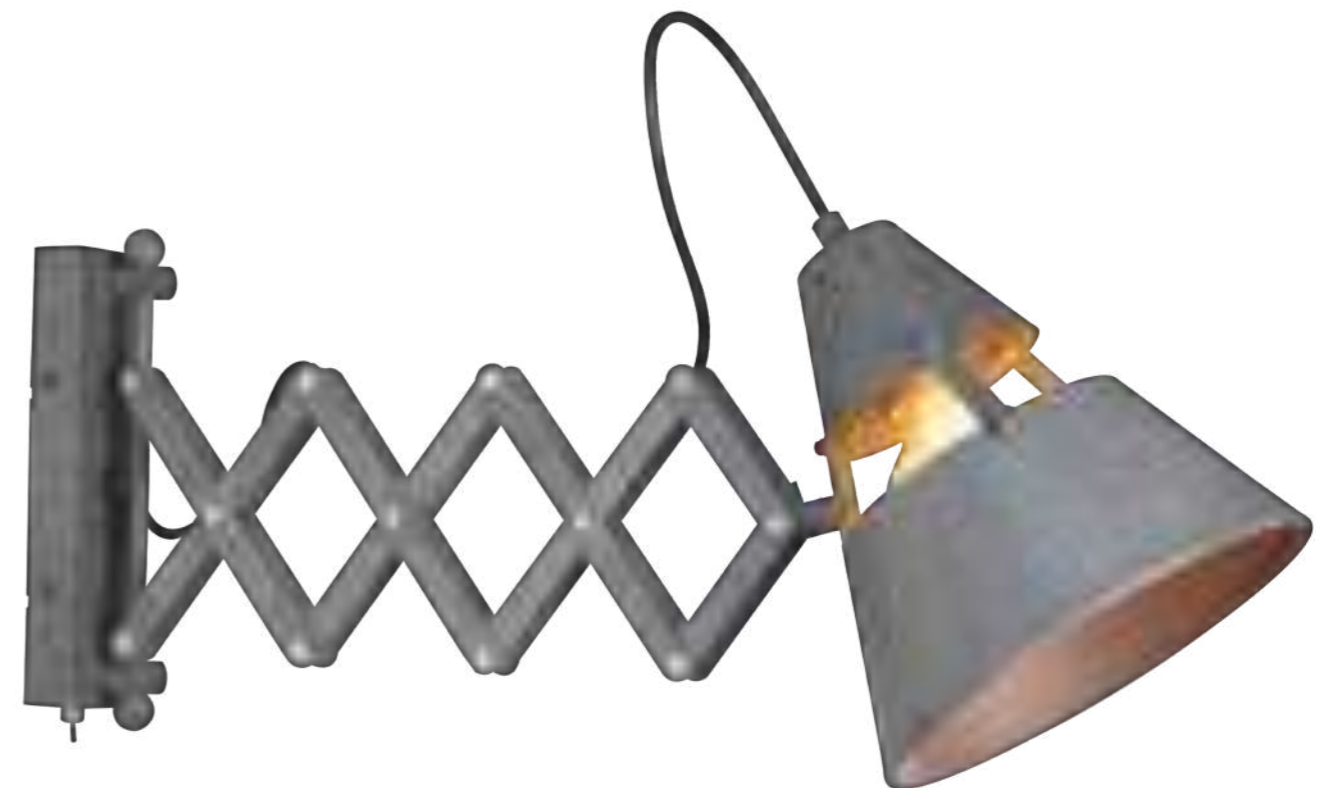

220-240V- 50/60Hz Acero - Steel

## MAUI

MAUI, es una serie de lámparas colgantes que dependiendo de la materia prima utilizada para su producción, puede ofrecer diversas personalidades: desde el frío cemento de carácter industrial y urbano, al blanco roto y la calidez de la madera. En cualquiera de estas versiones, la delicada línea que dibuja el perfil de MAUI emana sensaciones de frescura y tranquilidad que nos transportan a paisajes lejanos. Una lámpara adaptable a diversos tipos de proyectos, gracias a sus formas esenciales y orgánicas. MAUI transmite luz tanto por su parte inferior como superior, permitiendo iluminar la mesa y el techo a la vez, funcionando así, como un característico y original elemento de apoyo ornamental.

*MAUI, is a set of pendant lamps which depending on the raw material used for its production, can offer various personalities from the cold cement industrial and urban character, to the broken white and the Warmness of the wood. In any of these versions, the delicate line that draws the MAUI 's profile, emanates feelings of freshness and tranquility that transport us to distant landscapes. A lamp adaptable to various types of projects, due to its essential and organic forms. MAUI transmits light in two directions, upward and downward, allowing illuminate the table and ceiling at the same time, functioning as decorative and sculptural element support.*

Santiago Sevillano



OAMI 002562439-0003/Reg. ZL 201430440914.0



Maui

**Lámpara - Pendant Lamp**

Lacado Blanco - White Lacquer Chrome

**4813**

3x E27 máx.20W/no incl

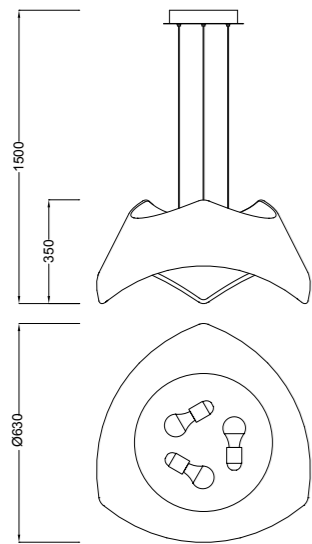
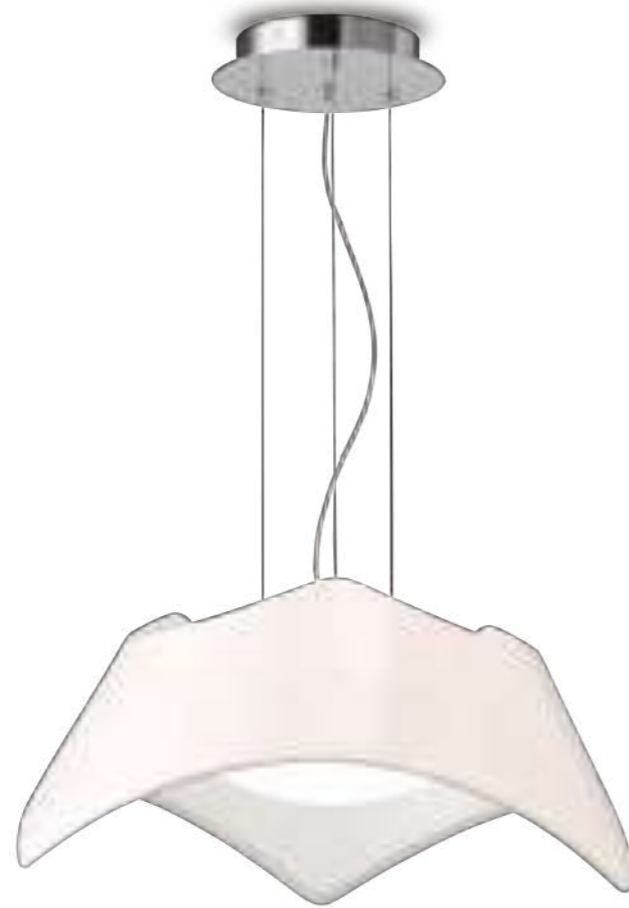

220-240V-50/60Hz PU/Acero/Acrílico - PU/Steel/Acrylic



4813





## ORGÁNICA

ORGÁNICA, Sorprendente y mágica, diseñada para ser un objeto clave dentro del espacio decorativo, funcional y a la vez estética, elegante pero transgresora, un objeto atemporal que pueda perdurar en el tiempo. Una vez más, el diseñador vuelve a inspirarse en la naturaleza para concebir la colección ORGÁNICA. Sus formas fluidas e irregulares están inspiradas en elementos marinos, corales, esponjas naturales, zonas rocosas marinas... estructuras aparentemente complejas, con multitud de cavidades y superficies porosas, trasladadas a un objeto funcional y cotidiano.

*ORGÁNICA, Surprising and magical, designed to be a key subject within the decorative space, functional and aesthetic, elegant and transgressive, a timeless object that can last over time. One more time, the designer is inspired in the nature for conceiving the collection ORGÁNICA. Its fluid and irregular shapes are inspired by marine elements, coral and natural sponges, sea rocky areas... apparently complex structures, with many cavities and porous surfaces, transferred to a functional and daily object.*

Hugo Tejada



OAMI 002987966-0018 / 002987966-0019



Orgánica

Lámpara - *Pendant Lamp*  
Cromo Blanco - *Chrome White*

**5140**  
3x E27 máx.20W/no incl

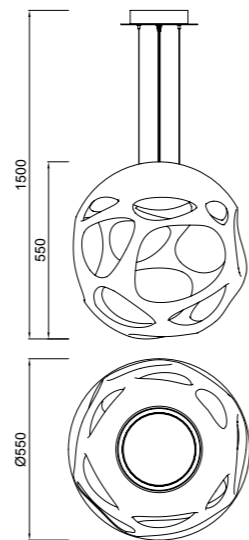

5140



220-240V~50/60Hz PU/Acero/Acrílico-PU/Steel/Acrylic



**Lámpara - Pendant Lamp**  
Cromo Blanco - Chrome White

**5145**  
3x E27 máx.20W/no incl

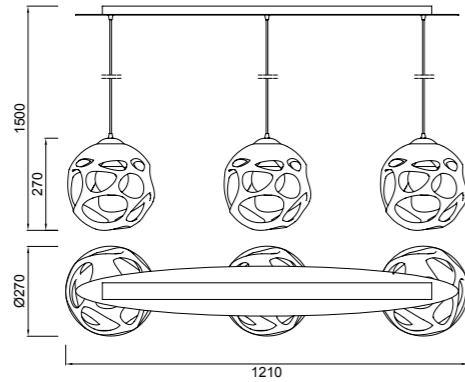

220-240V~50/60Hz PU / Acero / Acrílico - PU/Steel / Acrylic



**Lámpara - Pendant Lamp**  
Cromo Blanco - Chrome White

**5144**  
1x E27 máx.20W/no incl

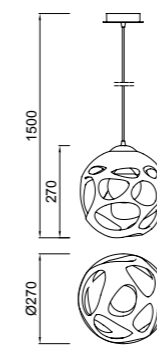

**Lámpara - Pendant Lamp**  
Cromo Blanco - Chrome White

**5141**  
3x E27 máx.20W/no incl

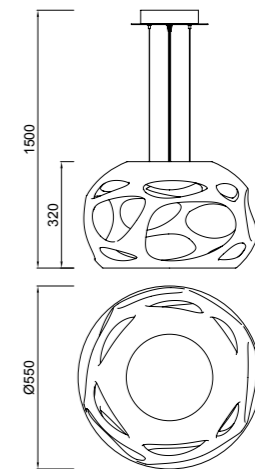

220-240V~50/60Hz PU / Acero / Acrílico - PU/Steel / Acrylic



Orgánica

**Plafón - Ceiling Lamp**  
Blanco - White

**5142**  
3x E27 máx.20W/no incl

**Plafón - Ceiling Lamp**  
Cromo Blanco - Chrome White

**5143**  
1x E27 máx.20W/no incl

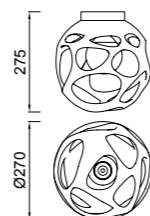
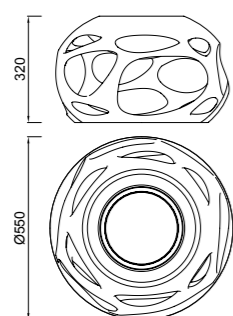

5142



220-240V-50/60Hz PU / Acero / Acrílico - PU/Steel / Acrylic



**Pie de Salón - Floor Lamp**

Blanco - White

**5146**

3x E27 máx.20W/no incl

**Sobremesa - Ceiling Lamp**

Cromo Blanco - Chrome White

**5147**

1x E27 máx.20W/no incl

Clase II

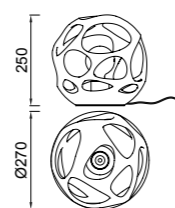
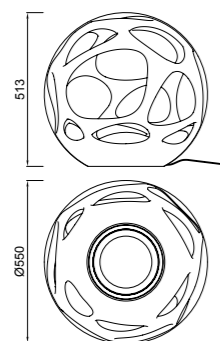



## NÓRDICA II

La exitosa colección Nórdica, crece con nuevas lámparas ampliando sus posibilidades de uso. Por un lado están los colgantes de 3 y 5 pantallas que completan la oferta de techo aportando un mayor volumen, pudiendo ser utilizadas tanto para dar luz general, como para situarlas sobre una mesa de comedor y un aplique con doble brazo de madera muy práctico y elegante. El resto de novedades; sobremesa, pie de lectura con mesa, y apliques con mesilla, incorporan una toma USB. Estos diseños nacen como respuesta a una necesidad de la gente, de poder recargar dispositivos electrónicos como teléfonos móviles de una forma cómoda y sencilla, manteniéndolos siempre al alcance de la mano para poder seguir utilizándolos. Tecnología y funcionalidad se funden con las pantallas y la madera en un diseño más dulce y humano.

*The successful Nordic collection grows with new lamps expanding its usability . On one side are the pendants of 3 and 5 shades, complete the offer of ceiling providing a greater volume, and can be used both to provide general light as to place them on a dining table, and a wall lamp with a wooden double arm very practical and elegant. The rest of novelties ; table, floor reading with table and wall lamps with bedside table, all incorporate a USB port. These designs are born in response to a need for people able to recharge electronic devices such as mobile phones in a convenient and easy way , always keeping them close at hand to continue using them. Technology and functionality merge with shades and wood in a sweeter and human design.*

Santolaria&Llusà



OAMI 003390038-0001 / 003390038-0002 / 003390038-0003 / 003390038-0004

**Pie de Salón - Floor Lamp USB**  
Blanco / Madera / Pantalla Blanca  
White / Wood / White Shade

**5465**  
1x E27 máx. 23W/no incl

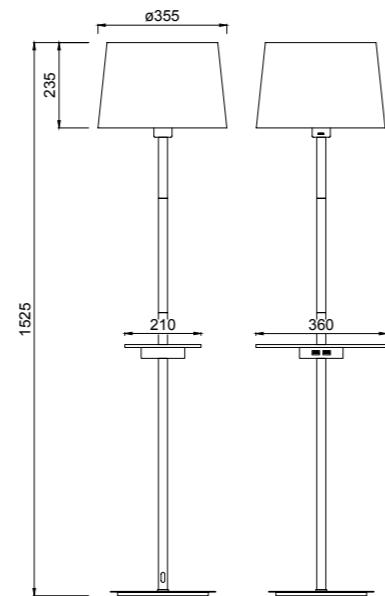

220-240V- 50/60Hz Acero / Madera / Plástico - Steel / Wood / Plastic





**Lámpara - Pendant Lamp**  
 Blanco/Madera/Pantalla Blanca  
 White/Wood/White Shade

**5460**  
 5x E27 máx.23W/no incl

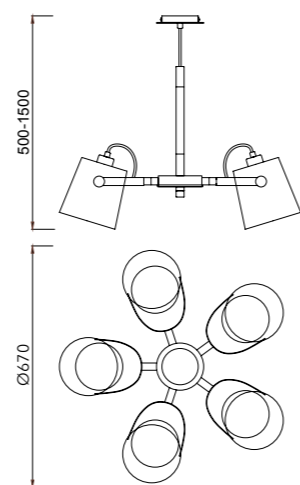

**Lámpara - Pendant Lamp**  
 Blanco/Madera/Pantalla Blanca  
 White/Wood/White Shade

**5461**  
 3x E27 máx.23W/no incl

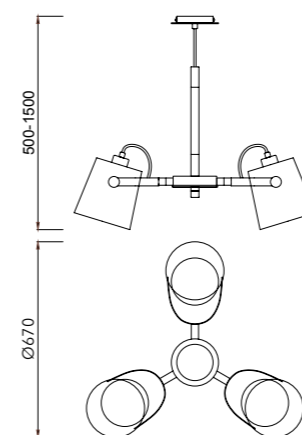

**Aplique - Wall Lamp USB**

Blanco/Madera/Pantalla Blanca  
White/Wood/White Shade

**5463**  
LED 3W 3000K 180 lm & USB Output

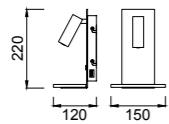

**Sobremesa - Table Lamp USB**

Blanco/Madera/Pantalla Blanca  
White/Wood/White Shade

**5464**  
1x E27 máx.23W/no incl & USB Output  
220-240V~ 50/60Hz

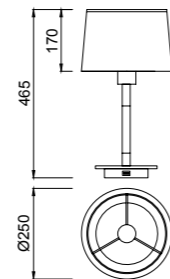

**Aplique - Wall Lamp USB**

Blanco/Madera/Pantalla Blanca  
White/Wood/White Shade

**5462**  
1x E27 máx.23W/no incl  
USB Output

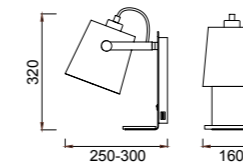

**Aplique - Wall Lamp**

Blanco/Madera/Pantalla Blanca  
White/Wood/White Shade

**5466**  
1x E27 máx.23W/no incl

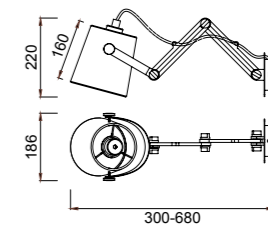

220-240V~ 50/60Hz Acero/Madera/Plástico - Steel/Wood/Plastic



220-240V~ 50/60Hz Acero/Madera/Plástico - Steel/Wood/Plastic



## NÓRDICA

Colección de lámparas que combinan pantallas traslúcidas que nos permite intuir el interior, con estructuras articuladas que combinan metal en acabado blanco o negro con madera natural, combinaciones modernas y atemporales que encajan con cualquier estilo. Calidez y funcionalidad van de la mano fundiendo el espíritu nórdico con el mediterráneo. NORDICA está diseñada para ambientes serenos donde se respira la tranquilidad del hogar, espacios íntimos que transmitan bienestar y pureza.

*This collection combines translucent shades that allows us to sense the interior, with articulated structures that combine metal in white or black with natural wood finish, modern and timeless combinations that fit with any style. Warmth and functionality walks hand in hand and makes fusion between Nordic Mediterranean style. NORDICA is designed for sober space, where you can enjoy comfort and pureness.*

Santolaria&Llusà



4920

OAMI 002987966-0015 OAMI 002621698/002 / 002621698/003 / 002621698/004 / 002621698/005 / 002621698/006 / 002987966-0015

Nórdica

Lámpara - Pendant Lamp

Blanco/Madera/Pantalla Blanca  
White/Wood/White Shade

4926

1x E27 máx.23W/no incl



Lámpara - Pendant Lamp

Negro/Madera/Pantalla Negra  
Black/Wood/Black Shade

4927

1x E27 máx.23W/no incl

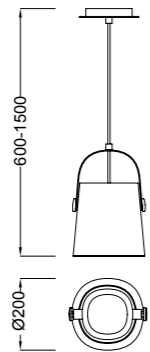

220-240V-50/60Hz Tela/Madera/Acero - Fabric/Wood/Steel



4926





Nórdica

**Lámpara - Pendant Lamp**  
Blanco/Madera/Pantalla Blanca  
White/Wood/White Shade

**4930**  
2x E27 máx.23W/no incl

**4928**  
1x E27 máx.23W/no incl



4930

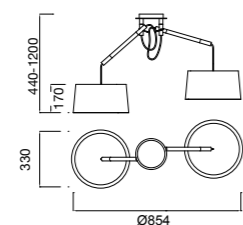

**Lámpara - Pendant Lamp**  
Negro/Madera/Pantalla Negra  
Black/Wood/Black Shade

**4931**  
2x E27 máx.23W/no incl

**4929**  
1x E27 máx.23W/no incl



4931



4928

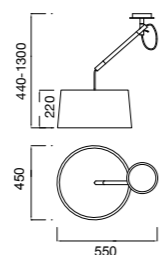

4929

4922 - 4930



220-240V-50/60Hz Tela/Madera/Acero - Fabric/Wood/Steel









**Aplique - Wall Lamp**

Blanco/Madera/Pantalla Blanca  
White/Wood/White Shade

**4924**  
1x E27 máx.23W/no incl

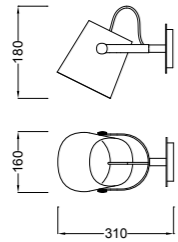

**Aplique - Wall Lamp**

Negro/Madera/Pantalla Negra  
Black/Wood/Black Shade

**4925**  
1x E27 máx.23W/no incl



220-240V-50/60Hz Tela/Madera/Acero - Fabric/Wood/Steel



**Pie De Salón - Floor Lamp**

Blanco/Madera/Pantalla Blanca  
White/Wood/White Shade

**4920**  
1x E27 máx.23W/no incl

Negro/Madera/Pantalla Negra  
Black/Wood/Black Shade

**4921**  
1x E27 máx.23W/no incl



220-240V-50/60Hz Tela/Madera/Acero - Fabric/Wood/Steel

**Sobremesa - Table Lamp**

Blanco/Madera/Pantalla Blanca  
White/Wood/White Shade

**4922**  
1x E27 máx.23W/no incl

Negro/Madera/Pantalla Negra  
Black/Wood/Black Shade

**4923**  
1x E27 máx.23W/no incl









**Kit Colgante - Pendant Kit**

**5033** Cromo - Chrome  
(4963E-4967E)



**5033 Kit**



**5033 Kit + 4963**

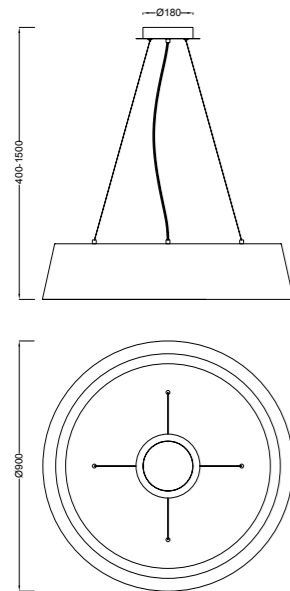

**Kit Colgante - Pendant Kit**

**5032** Cromo - Chrome  
(4962E-4966E)



**5032 Kit**



**5032 Kit + 4962**

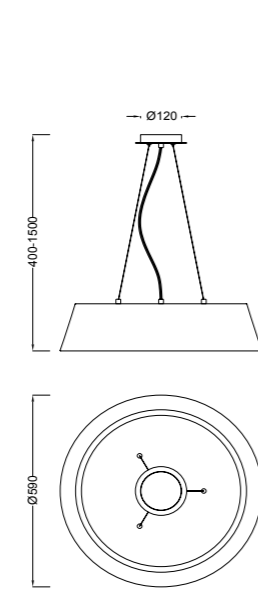

**Kit Colgante - Pendant Kit**

**5031** Cromo - Chrome  
(4961E-4965E)



**5031 Kit**



**5031 Kit + 4961**

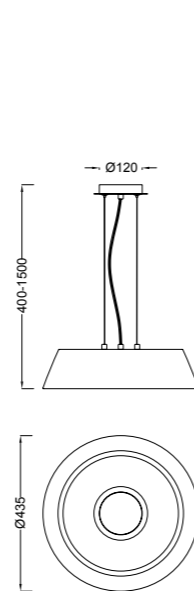

**Plafón - Ceiling Lamp**

Pantalla Blanca - White Shade

**4963E**  
9x E27 máx.20W/no incl



4963

**4962E**  
5x E27 máx.20W/no incl



4962

**4961E**  
3x E27 máx.20W/no incl



4961

**4960E**  
2x E27 máx.20W/no incl



4960

Pantalla Negra - Black Shade



4967

**4967E**  
9x E27 máx.20W/no incl



4966

**4966E**  
5x E27 máx.20W/no incl



4965

**4965E**  
3x E27 máx.20W/no incl



4964

**4964E**  
2x E27 máx.20W/no incl

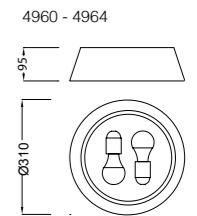
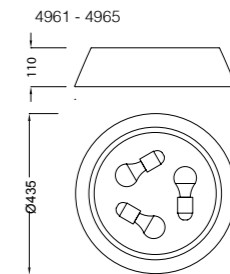
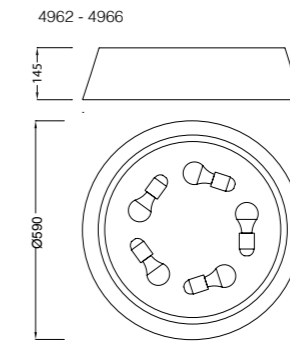
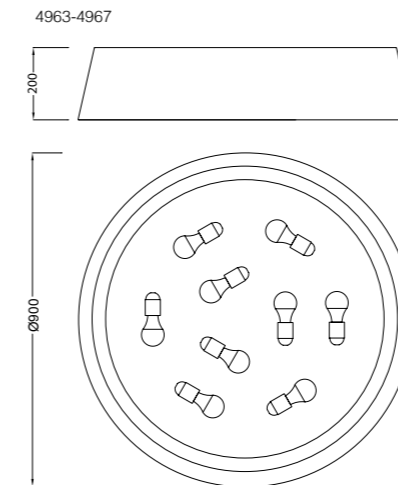

Acrílico / Acero - Acrylic / Steel



220-240V- 50/60Hz Tela / Acrílico / Acero - Fabric / Acrylic / Steel

**Pie De Salón- Floor Lamp**

(Solo Cuerpo) - (Only Body)  
Metal Negro - Black Metal

**4968**

1x E27 máx40W/no incl  
Color/Longitud cable: Negro/3m  
Color/Length wire: Black/3m

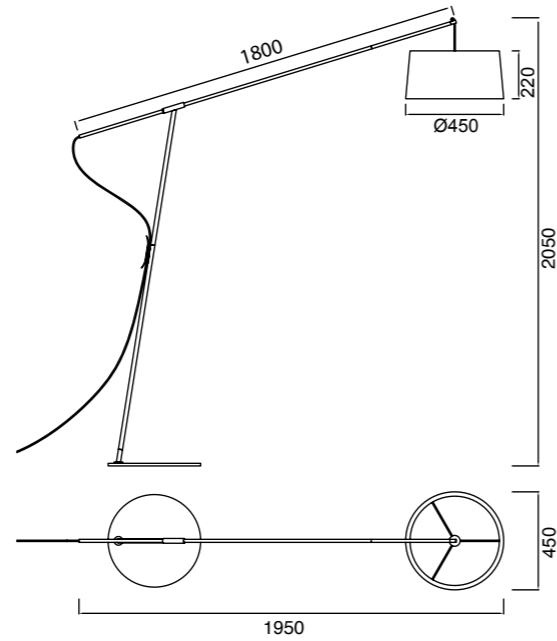

**Pantalla Redonda - Round Shade**

Opciones Pantallas - Lamp Shade Options

**5034**

Negro - Black  
Tela de fibra - Fiber cloth



**5035**

Blanco - White  
Tela de fibra - Fiber cloth

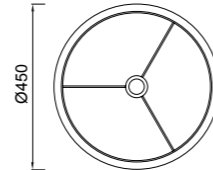

4968-5034



4968-5035



220-240V- 50/60Hz Acero - Steel





## LOOKER

LOOKER es una singular lámpara de estudio, con la que interactuar para que adopte esa posición que más te agrada. Diseñada por Santiago Sevillano, para que además de su luz nos aporte compañía, pues su simpática presencia seguro pasa a formar parte de ese especial lugar de tu hogar. Juvenil y fresca en su combinación de metal con apuntes de color, ... de aires nórdicos en su acabado de madera es perfectamente adaptable a zonas de estudio o aportar presencia como punto decorativo. Alberga luz de bajo consumo (E27). Sus acabados en versión de metal combinan el blanco con remates en pistacho o fresa. Y en la versión de madera natural con remates en blanco, no te serán indiferentes. Haz un sitio en tu espacio favorito... llega LOOKER.

*LOOKER is an exceptional study lamp; it can be easily adjusted in the position which pleases you most. Designed by Santiago Sevillano, it provides a light that accompanies us; its cosy safe presence will make your home a special place. Refreshingly young with a design that combines metal with touches of colour, it evokes a Nordic setting with its wood finish, perfectly adapted for study areas or to provide a bright presence as a decorative point. It houses low energy light (E27). Its finishes in the metal version combine the white colour with pistachio or strawberry finishes. The natural wood version with lovely white finishes will also impress you. Make room for a new light in your favourite space... LOOKER has arrived.*

Santiago Sevillano

3615



OAMI 002562439-0006 / 002562439-0007 / 002562439-0008 / Reg. ZL 201230533120.X / ZL 201330237194.3 / ZL 201330237195.8 / ZL 201330237193.9

**Lámpara - Pendant Lamp**  
Blanco/Madera - White/Wood

**3770**  
5x E27 máx.15W/no incl

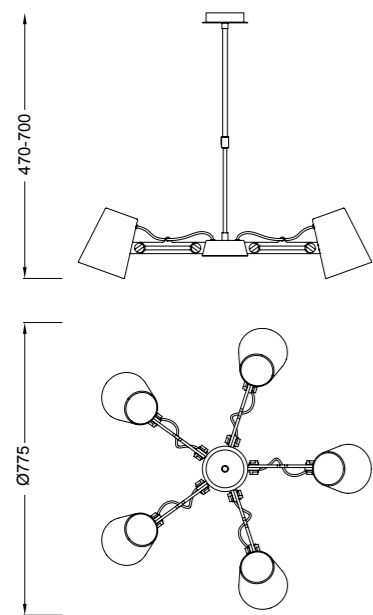

220-240V-50/60Hz Acero / Madera - Steel/Wood



**Lámpara - Pendant Lamp**  
Blanco/Madera - White/Wood

**3771**  
3x E27 máx.15W/no incl

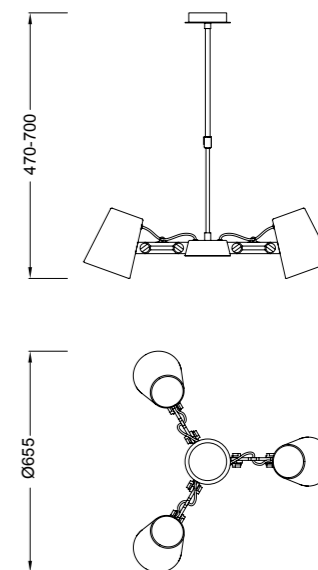

220-240V-50/60Hz Acero / Madera - Steel/Wood





**Sobremesa - Table Lamp**  
Blanco/Madera - White/Wood

**3615**  
1x E27 máx.15W/no incl

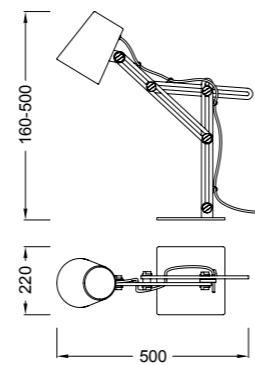

220-240V~50/60Hz Acero / Madera - Steel / Wood



**Aplique - Wall Lamp**  
Blanco/Madera - White/Wood

**3772**  
1x E27 máx.15W/no incl

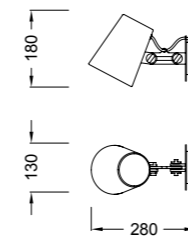

**Aplique - Wall Lamp**  
Blanco/Madera - White/Wood

**3773**  
1x E27 máx.15W/no incl

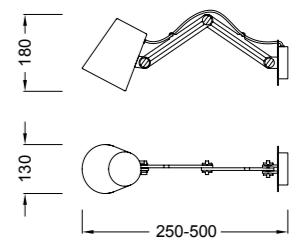

220-240V~50/60Hz Acero / Madera - Steel / Wood

## MEDITERRÁNEO

El efecto lumínico como protagonista, el valor de la sombras y las luces proyectadas por un objeto luminoso, Mediterráneo está diseñada para ser un concepto imperecedero, no es un objeto de tendencia, está destinado a perdurar en el tiempo. Mediterráneo se inspira en el movimiento de las olas, sus líneas orgánicas acentúan el carácter amigable de su pantalla, creando una sensación mágica a lo largo de su superficie de cristal. Gracias a la utilización de cristal de alta calidad la luz se difumina homogéneamente generando una iluminación dulce e íntima. La colección está compuesta por una gran variedad de aplicaciones y acabados metálicos, perfecta para ser utilizada en ambientes íntimos y acogedores o en grandes instalaciones.

*The lighting effect as protagonist, the value of shade and light projected in a luminous object, Mediterráneo is designed to be an enduring concept, It is not a trend object, It is destined to last over time. Mediterráneo is inspired by the movement of the waves, organic lines accentuate the kind of their screen, creating a magical effect along their glass surface. By using high quality glass, the light is sweet and intimate. The collection consists of a variety of applications and metallic finishes, this is perfect for use in intimate and cozy places or large premises.*

Hugo Tejada

3620 - 3621 - 3622



OAMI Reg. OAMI 002562439-0006 / 002562439-0007 / 002562439-0008 / Reg. ZL 201230531262.2 / ZL 201230531286.8



**Lámpara - Pendant Lamp**  
Cromo/Blanco - Chrome/ White

**3620**  
4x E27 máx.20W/no incl

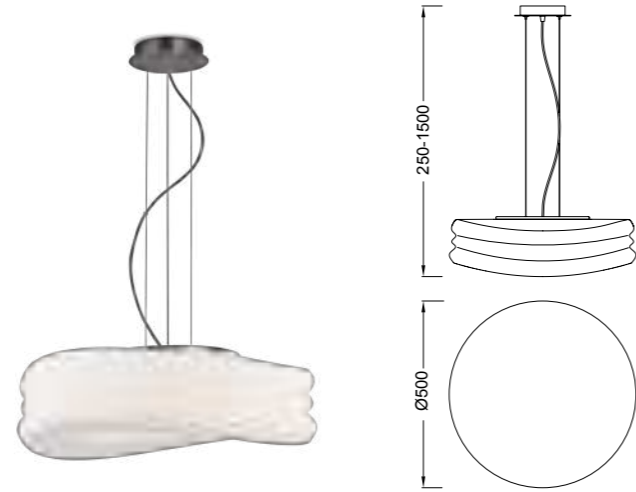

**Lámpara - Pendant Lamp**  
Cromo/Blanco - Chrome/ White

**3621**  
2x E27 máx.40W/no incl

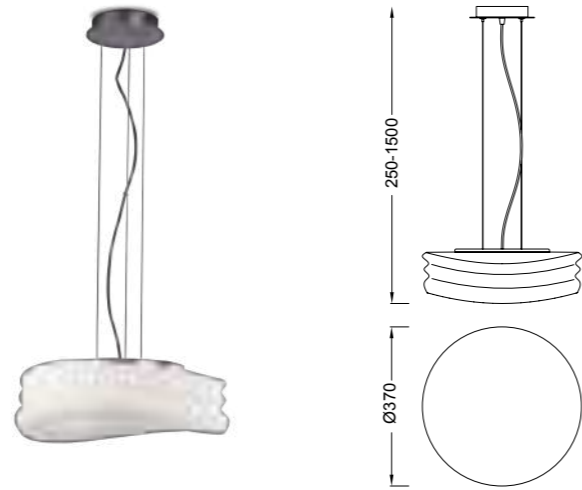

**Lámpara - Pendant Lamp**  
Cromo/Blanco - Chrome/ White

**3622**  
2x G9 máx.8W/no incl

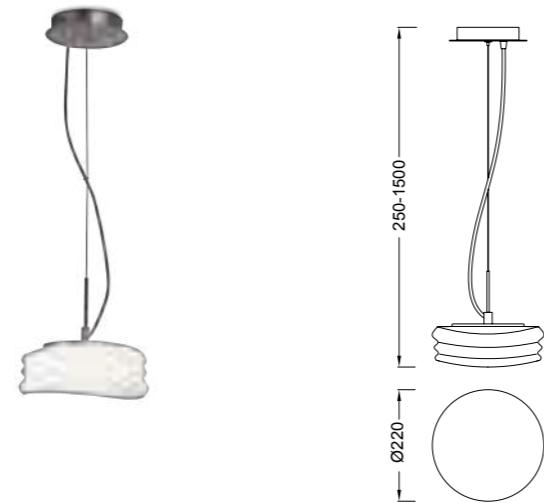

220-240V~ 50/60Hz Aluminio / Hierro - Steel / Glass





## Mediterráneo

### Plafón - Ceiling Lamp Blanco - White

**3623**  
4x E27 máx.20W/no incl

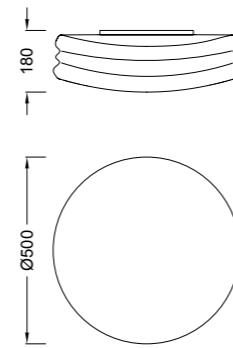

### Plafón - Ceiling Lamp Blanco - White

**3624**  
2x E27 máx.20W/no incl

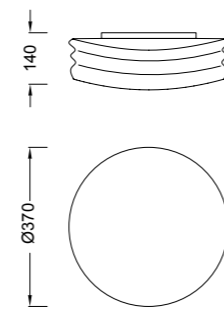

### Plafón - Ceiling Lamp Blanco - White

**3625**  
2x G9 máx.8W/no incl

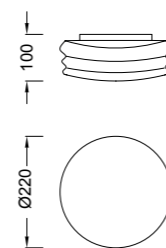

220-240V-50/60Hz Aluminio / Hierro - Aluminium / Iron





**Sobremesa - Table Lamp**  
Cromo/Blanco - Chrome/ White

**3626**  
2x E27 máx.20W/no incl

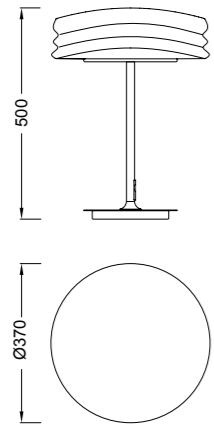

**Sobremesa - Table Lamp**  
Cromo/Blanco - Chrome/ White

**3627**  
2x G9 máx.8W/no incl

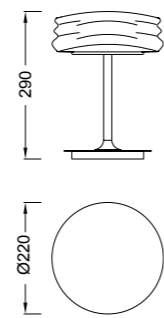

**Pie De Salón - Floor Lamp**  
Cromo/Blanco - Chrome/ White

**3628**  
2x E27 máx.20W/no incl

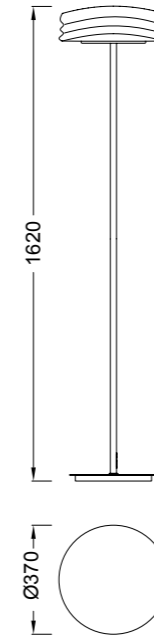

220-240V-50/60Hz Acero/Cristal - Steel/Glass



220-240V-50/60Hz Acero/Cristal - Steel/Glass

## KHALIFA

KHALIFA, juega con el brillo. KHALIFA es un sueño de las mil y una noches hecha luz. Esta lámpara se inspira en el mundo oriental del lujo y la geometría, aportándole una nueva dimensión mediante la luz y añadiendo un juego de fractales gracias a su cristal, que emite y expande multitud de reflejos. Dentro del más alto refinamiento, produce un increíble e interesante juego lumínico, creando un ambiente distinguido a la vez que proporciona un nivel decorativo inigualable.

Es un objeto que bebe del entorno y devuelve elegancia al espacio donde reside.

*KHALIFA, plays with brightness. KHALIFA is a arabic tale made light. This lamp is inspired by traditional luxury arabian world, bringing a new dimension by adding light and a set of fractals thanks to its crystal, which emits and expands many reflections. Within the highest refinement, it produces an amazing and interesting play of light, creating a distinguished ambient while providing an unmatched ornamental level. It is an object that drinks from the environment and returns elegance to the space it is placed in.*

Santiago Sevillano



OAMI 002987966-0016



**Lámpara - Pendant Lamp**  
Cromo - Chrome

**5161**  
3x GU10 máx.8W/no incl

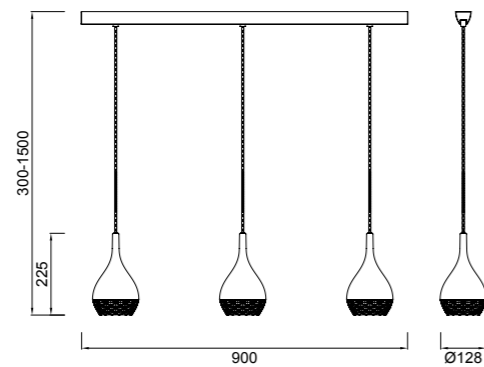

220-240V-50/60Hz Cristal / Acero - Glass / Steel

**Lámpara - Pendant Lamp**  
Cromo - Chrome

**5164**  
5x GU10 máx.8W/no incl

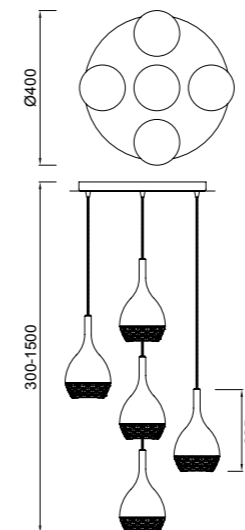
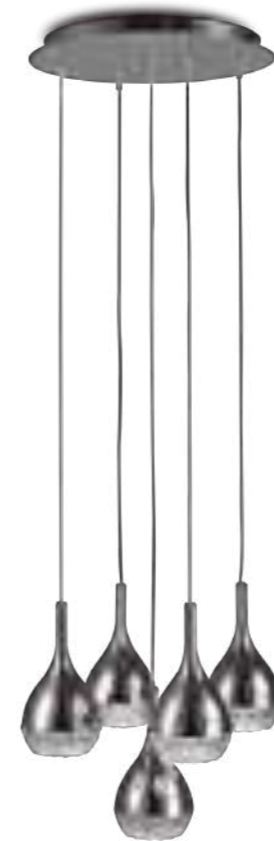

220-240V-50/60Hz Cristal / Acero - Glass / Steel

**Colgante - Pendant Lamp**  
Cromo - Chrome

**5160**  
1x GU10 máx.8W/no incl

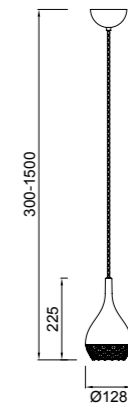

220-240V-50/60Hz Cristal / Acero - Glass / Steel

Lámpara - Pendant Lamp

Cobre - Chrome

5166

3x GU10 máx.8W/no incl

Colgante - Pendant Lamp

Cobre - Chrome

5165

1x GU10 máx.8W/no incl

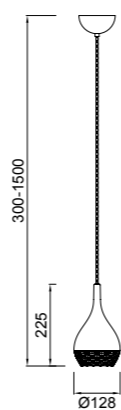
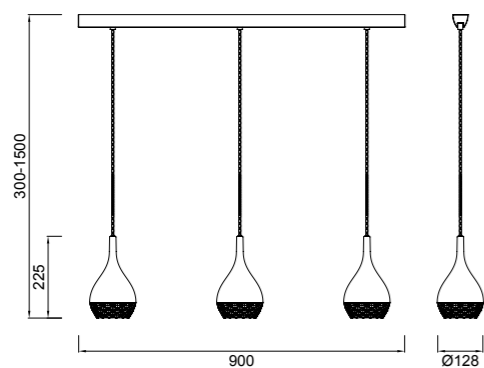

220-240V-50/60Hz Cristal/Acero - Glass/Steel





## ZACK

Es una colección de iluminación basada en una tulipa de cristal opal de gran formato de diseño romántico, por sus formas, pero de adaptación total a cualquier ambientación bien sea moderna, clásica e incluso de entorno vanguardista. Por su volumetría esta pensada para albergar vistiendo, la iluminación de bajo consumo. La colección la componen colgantes en racimo...lineales, y colgantes simples, ajustables todos ellos en altura. Así como pie de salón sobremesa y aplique de pared. La tulipa esta realizada en cristal opal soplado, trabajado y rematado manualmente. Sus elementos metálicos de complemento están en el acabado níquel mate.

*his lighting collection is based on an opal glass lampshade in a large format whose shapes have a romantic design, completely adapted to all environments, regardless if they are modern, classic or even avant-garde. Its volumetric design has been created to house decorative low-consumption light. The collection is comprised by hanging lamps in a grape bunch design, linear models, and simple hanging lamps, all height-adjustable. It also includes floor lamp, table lamp and wall lamp. The lampshade is executed in blown opal glass, manually handcrafted and finished. Its accessory metal elements have a dull nickel finish.*

José Ignacio Ballester



OAMI 1640509/0020 - Reg. ZL 200930286482.1

Zack

**Lámpara - Pendant Lamp**

Cristal Opal - *Opal Glass*

Níquel Satinado - *Satin Nickel*

**0771**

3x E27 máx 20W/no incl

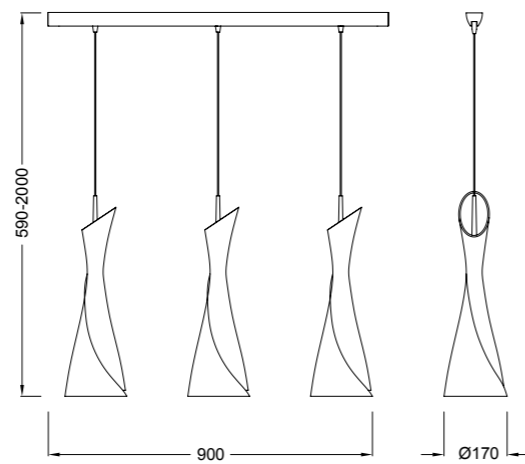

220-240V- 50/60Hz Acero / Cristal - Steel / Glass





**Lámpara - Pendant Lamp**

Cristal Opal - *Opal Glass*  
 Níquel Satinado - *Satin Nickel*

**0772**

1x E27 máx. 20W/no incl

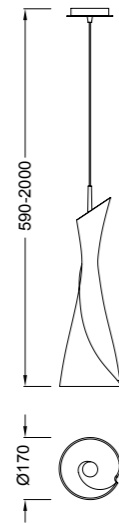

**Lámpara - Pendant Lamp**

Cristal Opal - *Opal Glass*  
 Níquel Satinado - *Satin Nickel*

**0770**

3x E27 máx20W/no incl

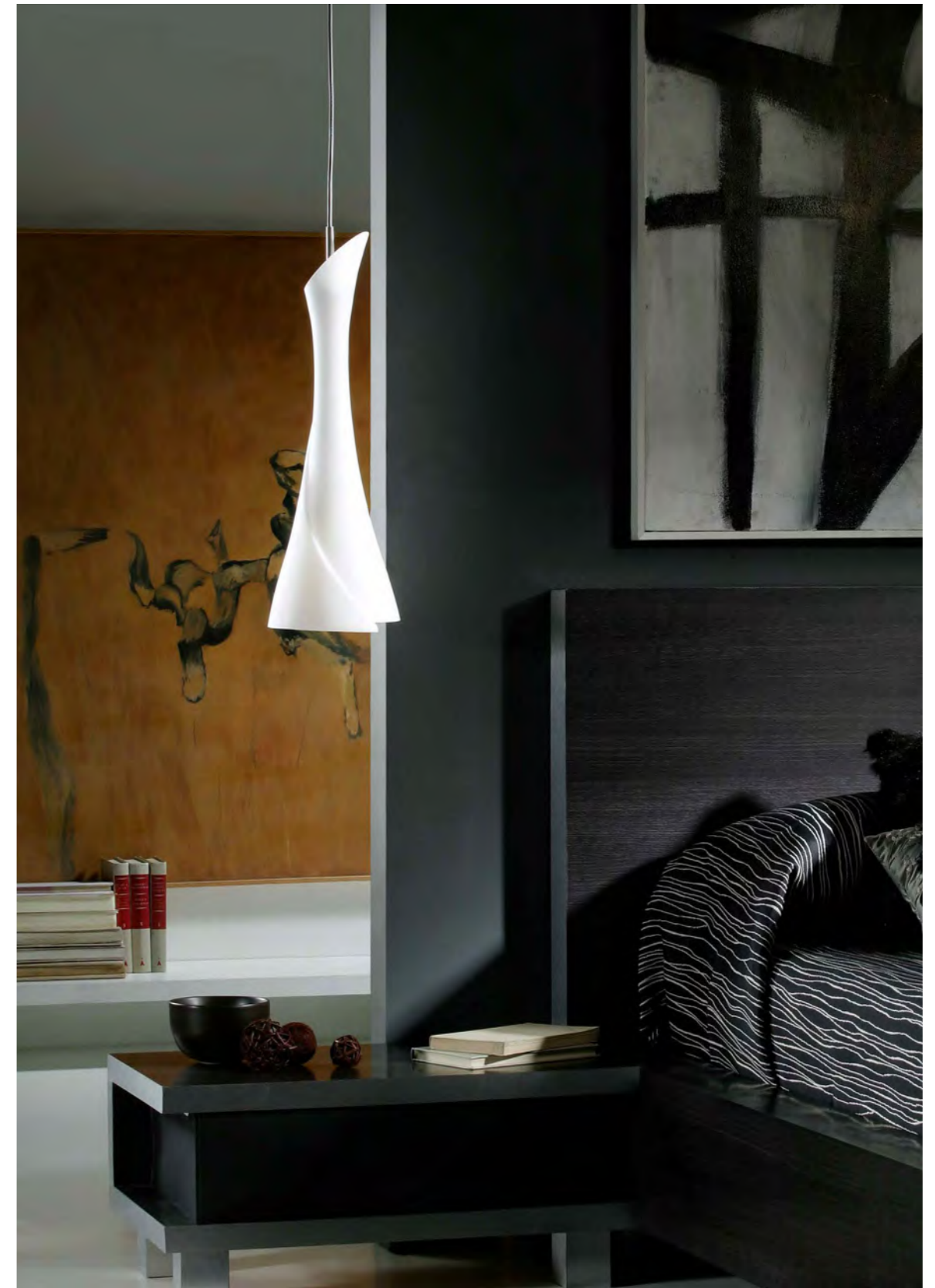
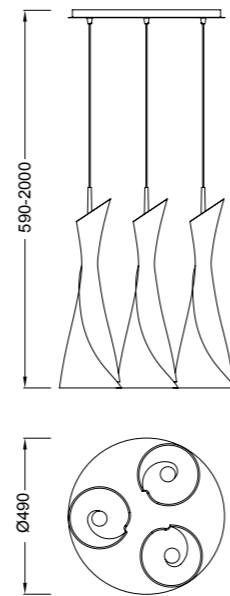

220-240V-50/60Hz Acero/Cristal - Steel/Glass



Zack

**Aplique - Wall Lamp**

Cristal Opal - *Opal Glass*  
Níquel Satinado - *Satin Nickel*

**0773**

1x E14 máx.20W/no incl

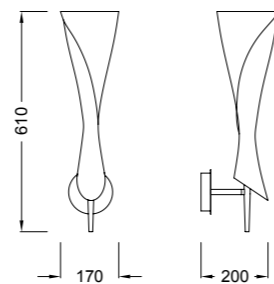

220-240V-50/60Hz Acero/Cristal - Steel/Glass





Zack

**Pie De Salón - Pendant Lamp**

Cristal Opal - *Opal Glass*  
Níquel Satinado - *Satin Nickel*

**0775**

1x E14 máx.20W/no incl

**Sobremesa - Table Lamp**

Cristal Opal - *Opal Glass*  
Níquel Satinado - *Satin Nickel*

**0774**

1x E14 máx.20W/no incl

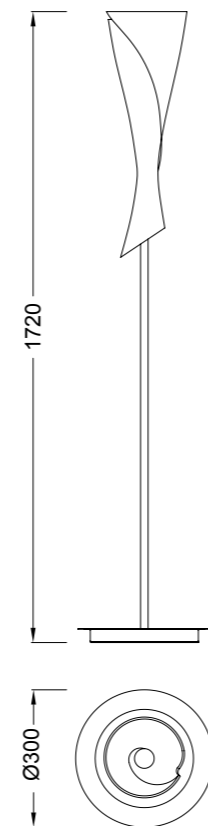
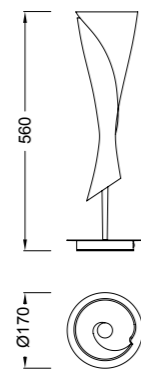

220-240V-50/60Hz Acero/Cristal - Steel/Glass



## QUATRO II

Esta luminaria LED está diseñada para complementar la colección QUATRO, esta vez el diseño se basa en la forma cuadrada de su volumen general. Diseñada por el equipo Mantra con la intención de complementar el sector de la iluminación de cocinas.

La colección combina tecnología y simplicidad para crear un objeto funcional y a la vez decorativo. QUATRO está fabricado en acrílico opal e incorpora fuente de luz led de alto rendimiento, su rendimiento lumínico es espectacular, ideal para cocinas contemporáneas que necesiten ser iluminadas de una manera eficiente y a su vez eficaz.

*This LED lighting is designed to match the QUATRO COLLECTION, This time the design is based on the square form of its common volume. It is designed by Mantra team with intention to complement the kitchen lighting section. The collection combines technology and simplicity to create a decorative, yet functional object. QUATRO is made of acrylic shade incorporated high-performance LED light source of which is spectacular light output, ideal for contemporary kitchens that needed to be illuminated efficiently and effectively.*

José Ignacio Ballester

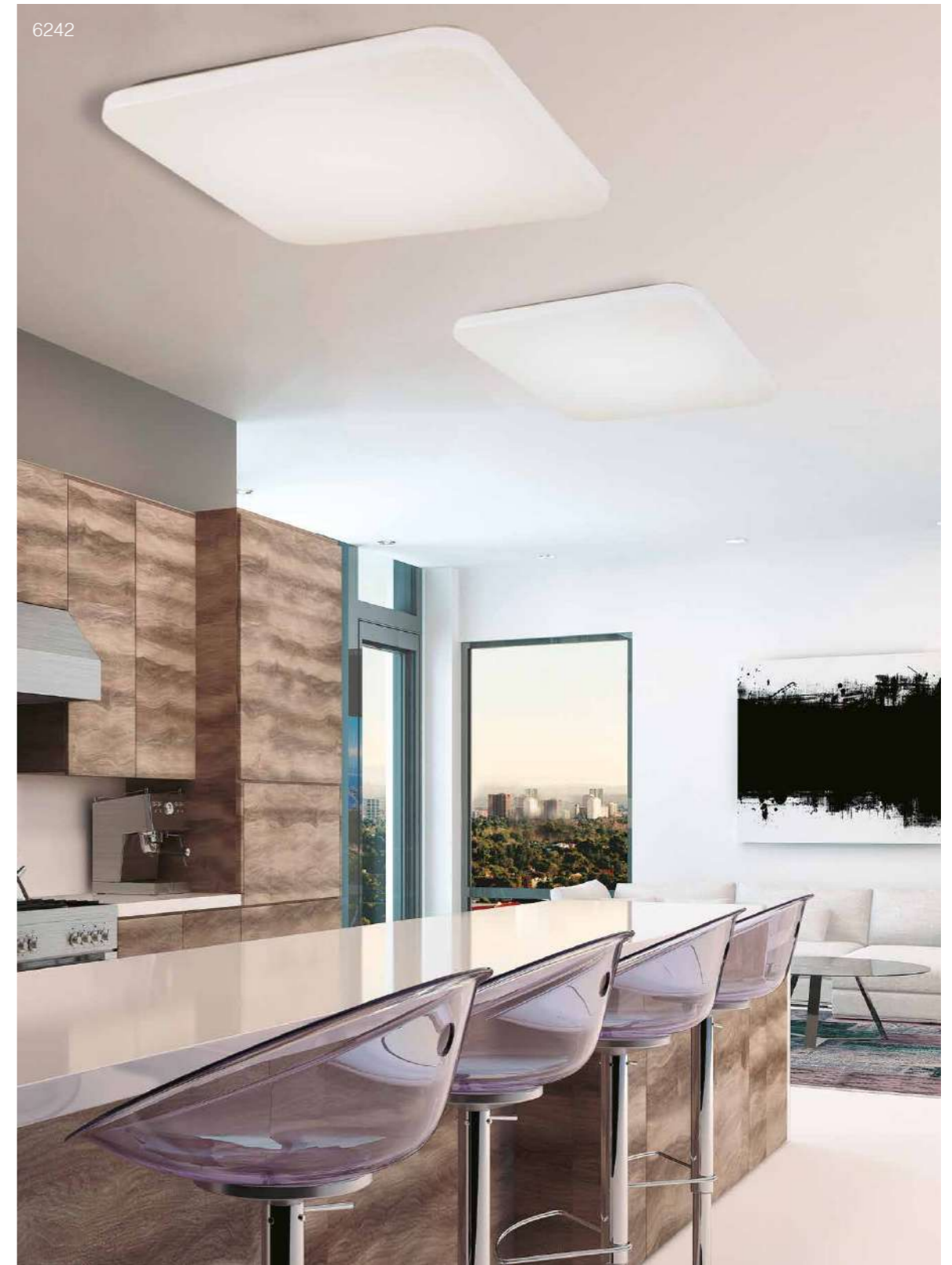

OAMI 002237214-0007



**Plafón - Ceiling Lamp**  
Blanco - White

**6240**  
LED 30W 3000K 1800lm

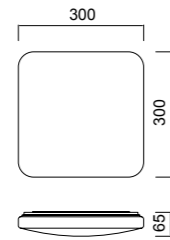

**Plafón - Ceiling Lamp**  
Blanco - White

**6243**  
LED 30W 5000K 2000lm



**Plafón - Ceiling Lamp**  
Blanco - White

**6241**  
LED 45W 3000K 2800lm



**Plafón - Ceiling Lamp**  
Blanco - White

**6244**  
LED 45W 5000K 3000lm



**Plafón - Ceiling Lamp**  
Blanco - White

**4870**  
LED 60W 3000K-6500K 3800lm  
Control Remoto - Remote Control  
Luz Noche - Night Light  
Dimable (frio-calor) - Regulable (cool-warm)

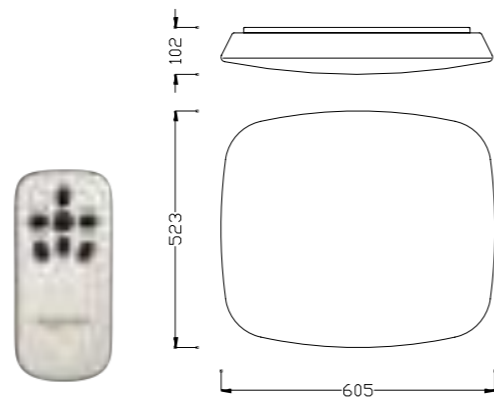

**Plafón - Ceiling Lamp**  
Blanco - White

**6242**  
LED 60W 3000K 3800lm



**Plafón - Ceiling Lamp**  
Blanco - White

**6245**  
LED 60W 5000K 4000lm



## EGG

EGgg es una colección de plafones, diseñada por José Ignacio Ballester, de líneas informales y amorfas. Su luz interior proyectada sobre sus suaves formas orgánicas se distribuye de manera agradable y difusa, sin proyectar sombra alguna. Realizada en inyección plástica de polietileno, alberga en su interior portalámparas de E27 para poder colocar luz led o bajo consumo. Estando homologada para poder ser instalada en lugares cubiertos al exterior, ya que goza de IP44. Como detalles complementarios presentan una placa central de acero inox, dándole un toque personal y especial.

*Egg is a collection of panels, designed by Jose Ignacio Ballester, informal and amorphous lines. The interior light projected onto her soft organic shapes nice and is distributed diffusely, casting no shadow. Made of polyethylene plastic injection, contains in its interior lamp to put E27 or low energy LED light. Being eligible to be installed in locations covered outside, and enjoying IP44. As additional details have a central plate stainless steel, giving a personal and special touch.*

José Ignacio Ballester



OAMI 001793845-0004 / 001793845-0005 / ZL 201030595261.5 / ZL 201030595265.3



**Plafón - Ceiling Lamp**

Cromo - Chrome

Difusor polietileno - Polyethylene Diffuser

**1335**

6x E27máx.13W/no incl

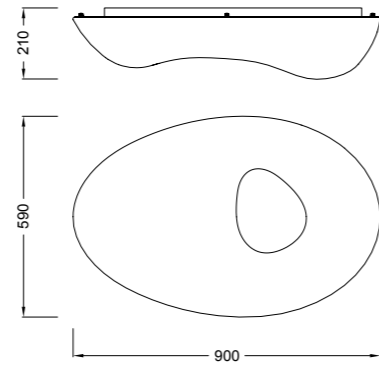
**Plafón - Ceiling Lamp**

Cromo - Chrome

Difusor polietileno - Polyethylene Diffuser

**1334**

5x E27máx.13W/no incl

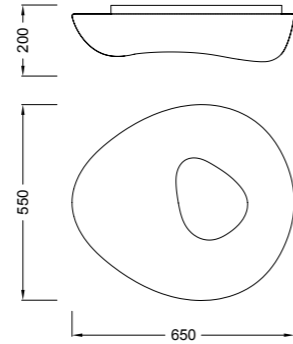
**Plafón - Ceiling Lamp**

Cromo - Chrome

Difusor polietileno - Polyethylene Diffuser

**1336**

4x E27máx.13W/no incl

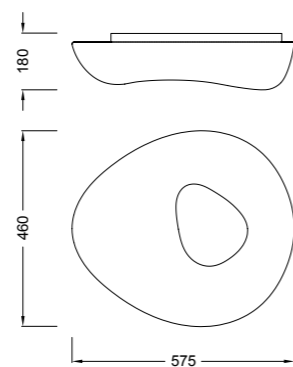

220-240V- 50/60Hz Acero / PE - Steel / PE



# EOS MUSIC

Desde que años atrás José Ignacio Ballester las creara para MANTRA, las nubes de la colección *Eos* han pasado a ser parte de muchos hogares. Dada su versatilidad y exitosa aceptación, MANTRA ha querido distinguir al dotar de equipación de sonido bluetooth a este, el modelo intermedio de "nube", que por tamaño y diseño se ha convertido en el más popular de la colección. *Eos* pues, a partir de ahora, será también acompañamiento de luz y sonido ambiental en tu hogar.

*Some years ago, Jose Ignacio Ballester created for MANTRA; EOS the clouds' collection has been renewed to accompany many households. Given its versatility and successful acceptance, Mantra required distinguishing it with Bluetooth sound equipment to the intermediate "cloud" which is the most popular size and design among its collection. EOS, so from now on, accompany your home with light and sound.*

José Ignacio Ballester

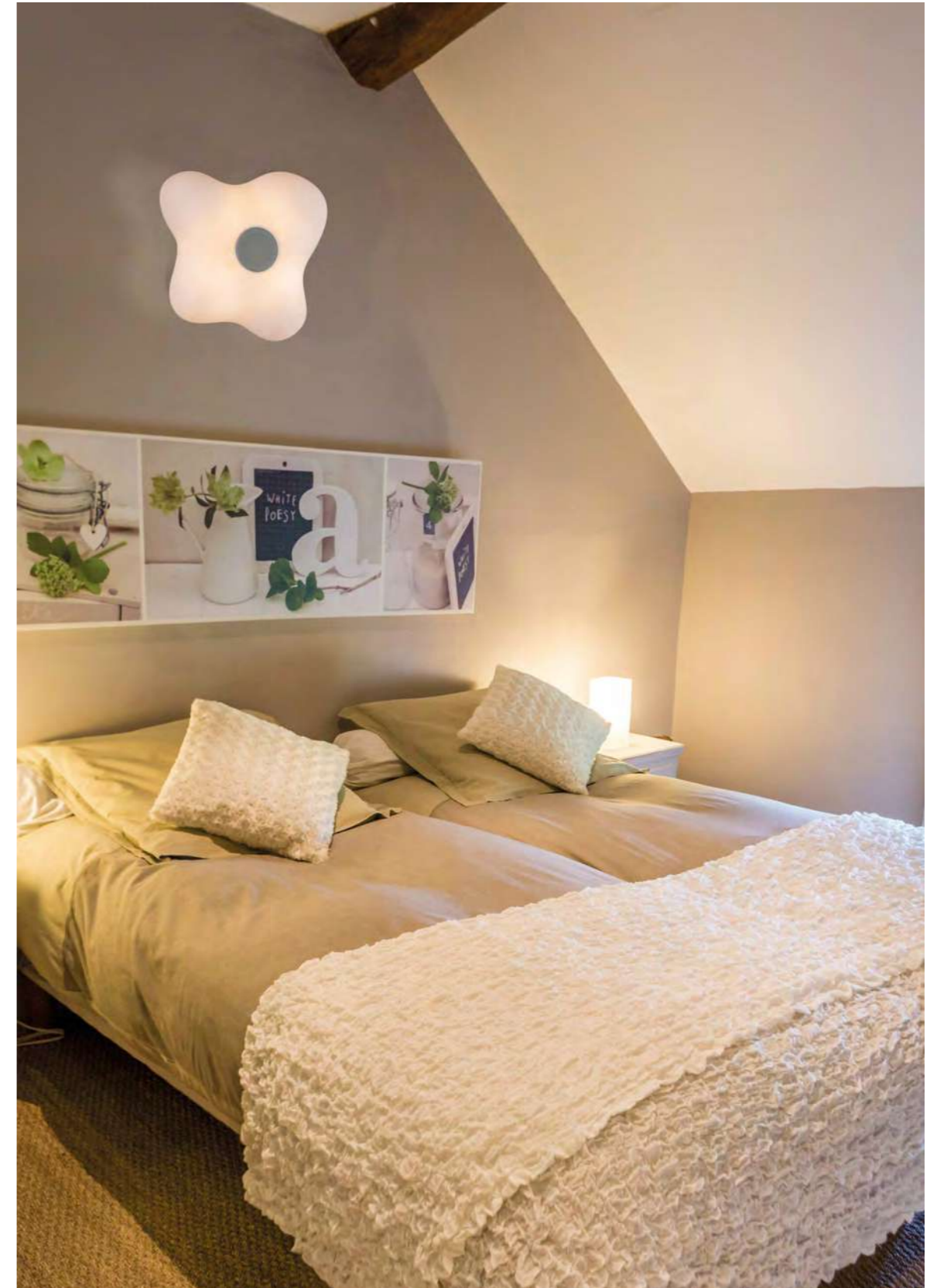

OAMI 003854025-0006



**Plafón & Altavoz - Ceiling Lamp & Speaker**  
Blanco - White

**5874**  
4x E27 máx.20W/no incl

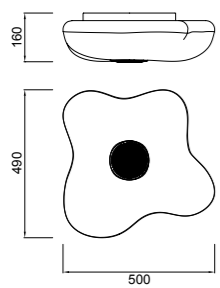

220-240V- 50/60Hz Acero / PE - Steel / PE



## EOS

EOS, replica las formas de las nubes y alberga una instalación alimentada por bombillas de bajo consumo, cuya luz es repartida de forma difusa y eficaz. Cuentan con el IP44 que las posibilita tanto para su instalación en interior como en el exterior bajo techado, también con una pieza convertible en lámpara de salón, suspendida con sistema de cable de acero.

*EOS recreates the shapes of clouds and houses an installation supplied by low-consumption light bulbs whose light is distributed in an efficient glow. It is equipped with IP44 which facilitates its installation in an indoor or outdoor sheltered location, It is also equipped with a piece which can be converted into a living room lamp, hung with a steel cable system.*

José Ignacio Ballester



OAMI 002054213-0001 / Reg. ZL 201330237148.3



**Colgante - Pendant Lamp**  
Blanco+Cromo - White+Chrome

**1883**  
4x E27 máx.13W/no incl

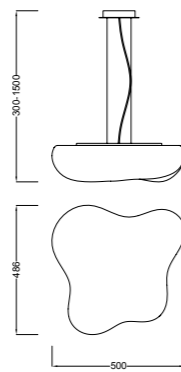
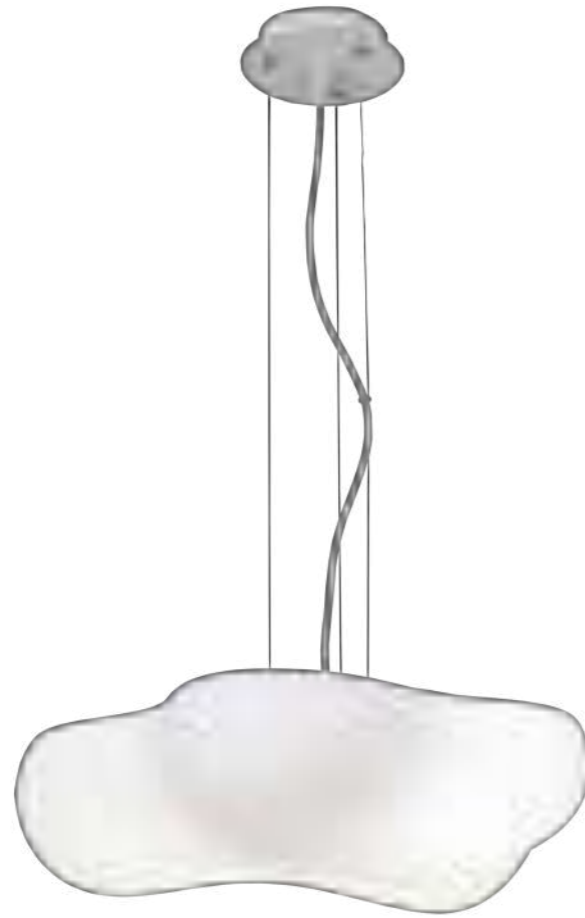

220-240V~50/60Hz Acero/Cristal - Steel/Glass

**Colgante - Pendant Lamp**  
Blanco+Cromo - White+Chrome

**1880**  
6x E27 máx.13W/no incl

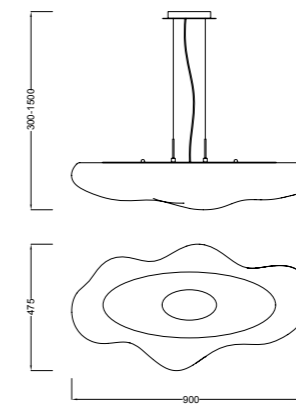

220-240V~50/60Hz Acero/Cristal - Steel/Glass



**Aplique/Plafón - Wall/Ceiling Lamp**  
Blanco - White

**1885**  
LED 3W 3000K 280lm

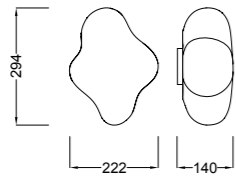

**Plafón - Ceiling Lamp**  
Blanco+Cromo - White+Chrome

**1881**  
6x E27 máx.13W/no incl

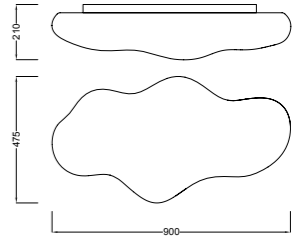

**Plafón - Ceiling Lamp**  
Blanco+Cromo - White+Chrome

**1882**  
4x E27 máx.13W/no incl

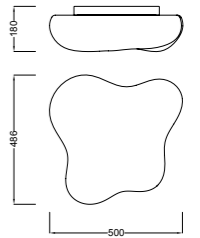

220-240V-50/60Hz Acero / Cristal - Steel / Glass



## SABINA

La tendencia creciente del "Brutalismo" en el interiorismo, ha sido interpretada por José Ignacio Ballester con la colección SABINA. Sabina, de suaves trazos rústicos, emula las texturas y colores de la madera con sus construcciones metálicas decoradas al efecto. Elementos que combinan pantallas de arpillera en distintos tamaños y cables electrificados con revestimiento textil, emulando la cuerda, que sustentan los elementos en el aire formando composiciones de distintos formatos, enlazándolas con simples nudos. Ambientes rústicos de montaña o rincones junto al mar al más estilo ibicenco, son perfecto lugar para presentar cualquiera de sus propuestas de techo y sus auxiliares, vistiendo estéticamente y de manera diferente su lugar elegido.

*The growing trend of "Brutalism" in interior design has been interpreted by José Ignacio Ballester with the SABINA collection. SABINA, with soft rustic strokes, emulates the textures and colors of the wood with its metal constructions decorated to such effect. Elements that combine burlap shades in different sizes and electrified cables with textile covering, emulating the rope, which support the elements in the air forming compositions of different formats, lacing up with simple knots. Rustic mountain ambiances or seaside Ibiza style corners are the perfect place to display these ceiling proposals, dressing aesthetically and in a unique way your favourite place.*

José Ignacio Ballester

6179



OAMI 004721413 - 014 / 015 / 016 / 017











**Colgante - Pendant Lamp**

Decorado madera - *Decorated wood*  
Cable revestimiento textil - *Fabric coated cable*

**6177**

2 x E27 máx.40W/no incl

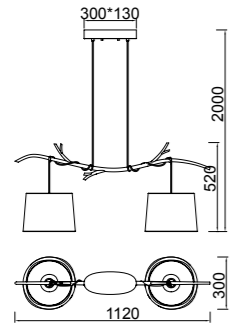

220-240V- 50/60Hz Hierro / Tela - Iron / Fabric





**Colgante - Pendant Lamp**

Decorado madera - *Decorated wood*  
 Cable revestimiento textil - *Fabric coated cable*

**6175**

5 x E27 máx.40W/no incl

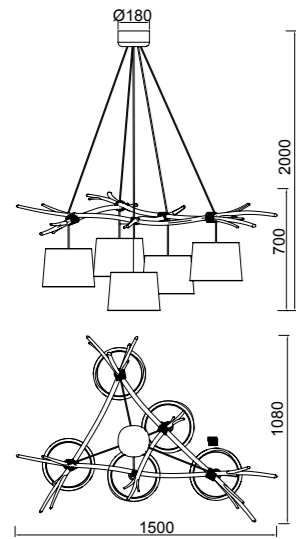

**Colgante - Pendant Lamp**

Decorado madera - *Decorated wood*  
 Cable revestimiento textil - *Fabric coated cable*

**6176**

3 x E27 máx.40W/no incl

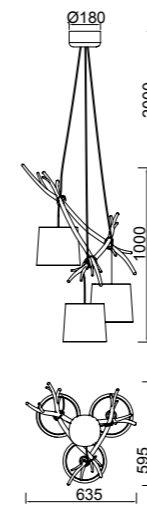

220-240V- 50/60Hz Hierro /Tela - Iron/Fabric



220-240V- 50/60Hz Hierro /Tela - Iron/Fabric

**Colgante - Pendant Lamp**

Decorado madera - *Decorated wood*  
Cable revestimiento textil - *Fabric covert cable*

**6178**  
1 x E27 máx.40W/no incl

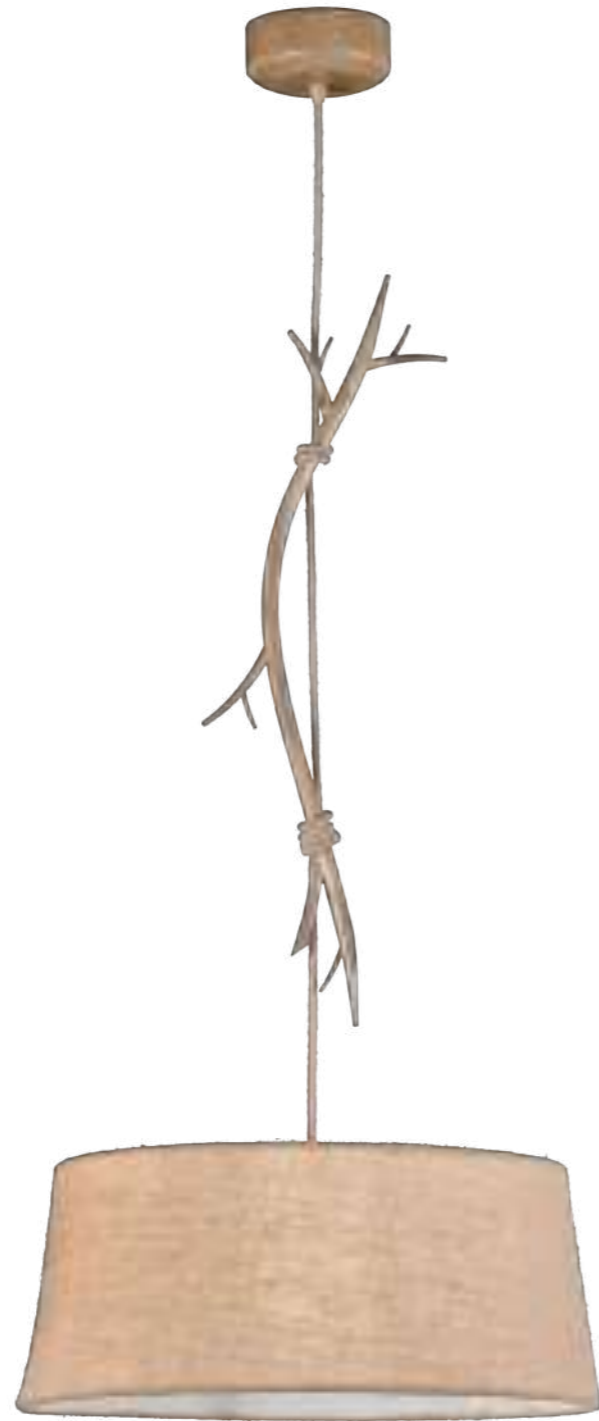
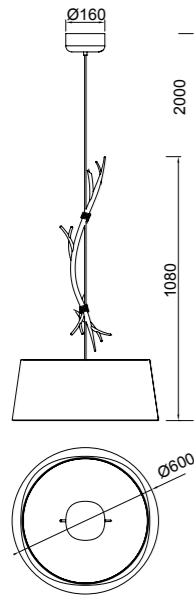

**Colgante - Pendant Lamp**

Decorado madera - *Decorated wood*  
Cable revestimiento textil - *Fabric covert cable*

**6179**  
1 x E27 máx.40W/no incl

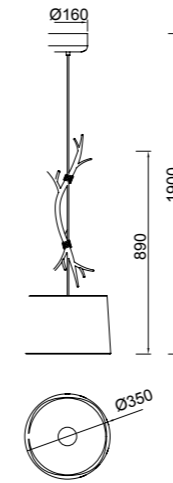

**Colgante - Pendant Lamp**

Decorado madera - *Decorated wood*  
Cable revestimiento textil - *Fabric covert cable*

**6410**  
1 x E27 máx.40W/no incl

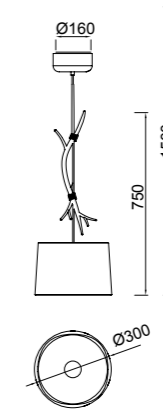

220-240V- 50/60Hz Hierro /Tela - Iron /Fabric



220-240V- 50/60Hz Hierro /Tela - Iron /Fabric



**Pie De Salón - Floor lamp**

Decorado madera - *Decorated wood*  
 Cable revestimento textil - *Fabric covert cable*

**6182**  
 1 x E27 máx.40W/no incl

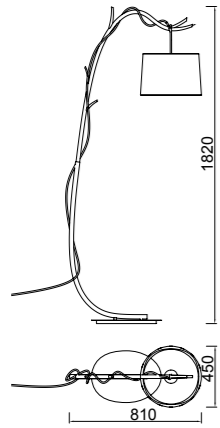

**Sobremesa - Table Lamp**

Decorado madera - *Decorated wood*  
 Cable revestimento textil - *Fabric covert cable*

**6181**  
 1 x E27 máx.40W/no incl  
 Clase:II

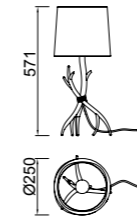

**Aplique - Wall Lamp**

Decorado madera - *Decorated wood*  
 Cable revestimento textil - *Fabric covert cable*

**6180**  
 1 x E27 máx.40W/no incl  
 Clase:I

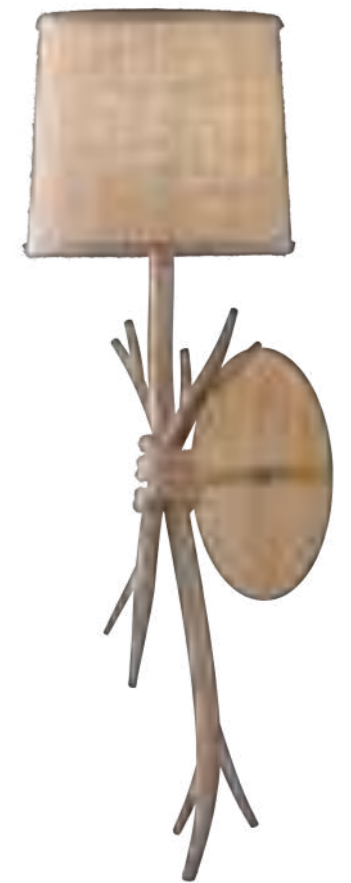
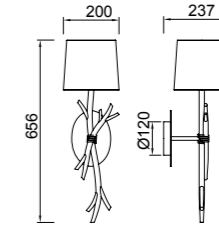

220-240V- 50/60Hz Hierro / Tela - Iron / Fabric



220-240V- 50/60Hz Hierro / Tela - Iron / Fabric

**Plafón - Ceiling Lamp**  
Pantalla Arpillera - Burlap shade

**6411**  
9x E27 máx.20W/no incl

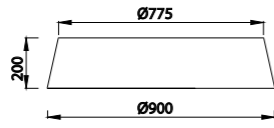

**6412**  
5x E27 máx.20W/no incl

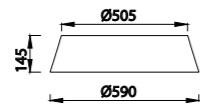
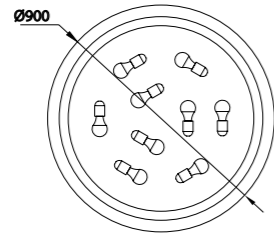

**6413**  
3x E27 máx.20W/no incl

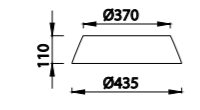
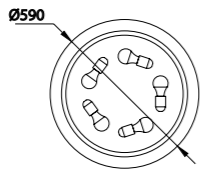

**6414**  
2x E27 máx.20W/no incl

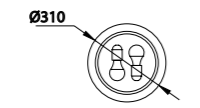
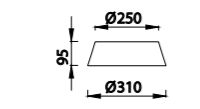
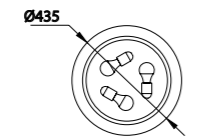

**Kit Colgante - Pendant Kit**  
Cromo - Chrome

kit 5033 + 6411

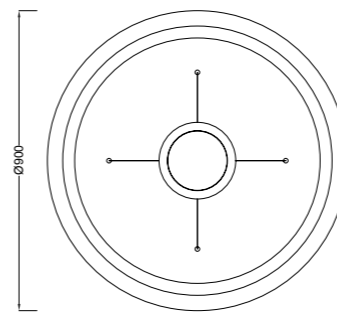
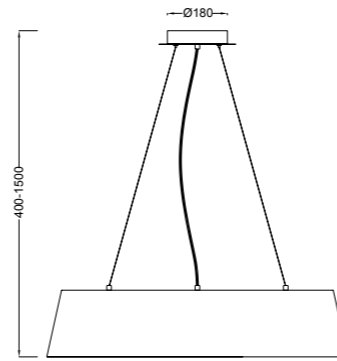

kit 5032 + 6412

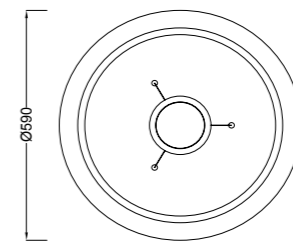
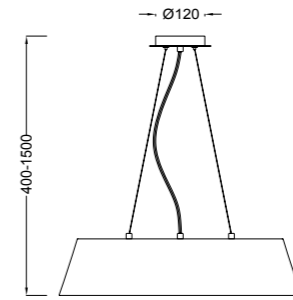
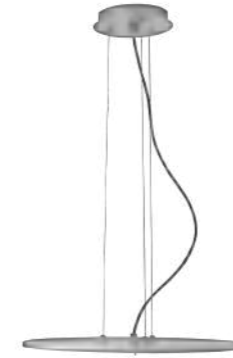

kit 5031 + 6413

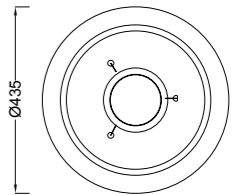
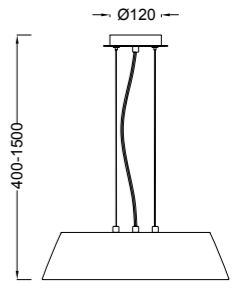
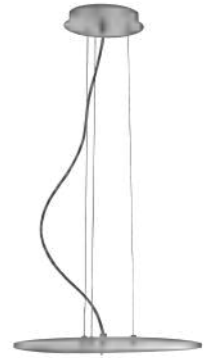

6213



6211



220-240V- 50/60Hz Hierro /Tela - Iron/Fabric



Acabado: Acrílico /Acero - Acrylic /Steel



# Andrea

Colección de iluminación pensada como propuesta de actualización de los "clásicos". De líneas agradables y frescas, realizando un guiño a las composiciones de antaño. Combinando materiales y acabados atrevidos, como sus pantallas de textura piel en blanco (que una vez iluminadas nos transmiten luz cálida ambiental), con copens que matizan en las composiciones un contrapunto por contraste (en color blanco para el acabado cuero y negro para los cromos) en las suaves y sinuosas líneas de sus estructuras. ANDREA es un nuevo clásico para vestir de manera elegante los más sofisticados ambientes, sin perder el carisma de la iluminación de siempre.

*A series of lighting designed as a proposal to update the "classics". Of pleasant and fresh lines, giving a wink to yesteryear compositions. Combining daring materials and finishings, such as white skin textured shades (which produce a warm atmosphere), with crystals that tint in the compositions a contrasting counterpoint (transparent crystal for the antique brass and black crystal for the chromes) in the soft and sinuous lines of their structures. ANDREA is a new classic to dress stylishly the most sophisticated places, without losing the charisma of conventional lighting.*





6317



6319/6311



**Colgante - Pendant Lamp**  
Cromo - Chrome

**6310**  
8+4 Luces  
12 x E14 máx.20W/no incl

**6311**  
6+3 Luces  
9 x E14 máx.20W/no incl

**6312**  
8 Luces  
8 x E14 máx.20W/no incl

**6314**  
5 Luces  
5 x E14 máx.20W/no incl

**6315**  
3 Luces  
3 x E14 máx.20W/no incl

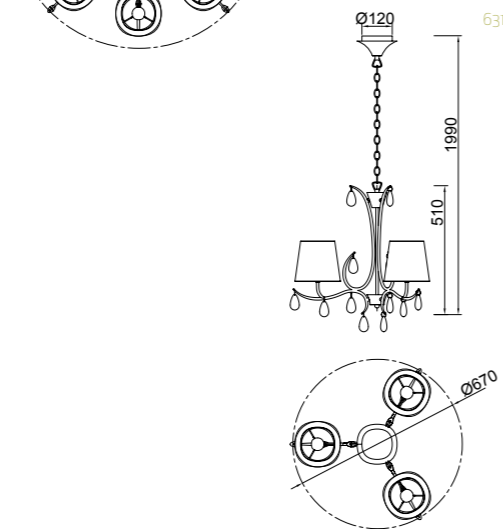
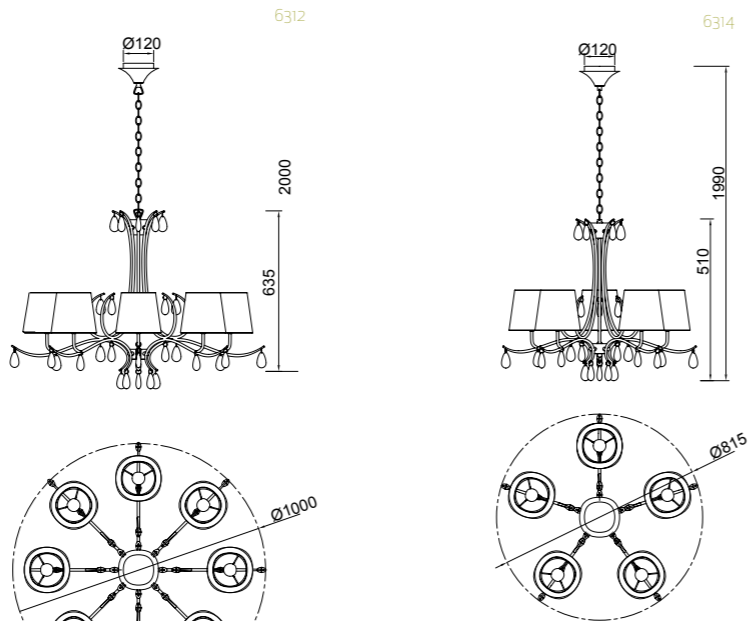
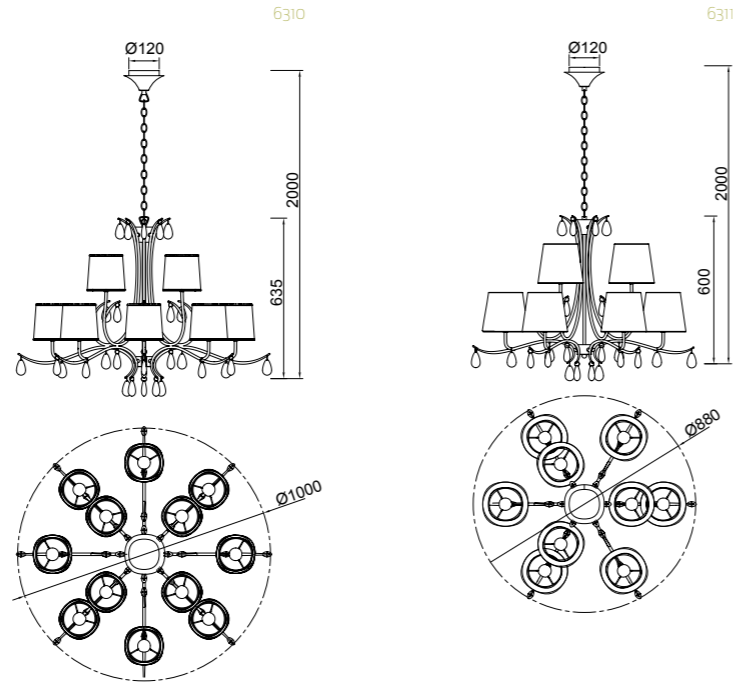

**Colgante - Pendant Lamp**  
Cuero satinado - Antique brass

**6330**  
8+4 Luces  
12 x E14 máx.20W/no incl

**6331**  
6+3 Luces  
9 x E14 máx.20W/no incl

**6332**  
8 Luces  
8 x E14 máx.20W/no incl

**6334**  
5 Luces  
5 x E14 máx.20W/no incl

**6335**  
3 Luces  
3 x E14 máx.20W/no incl

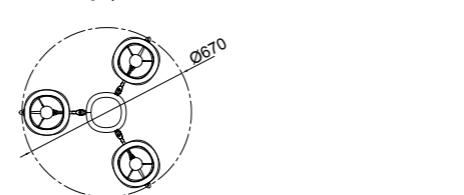
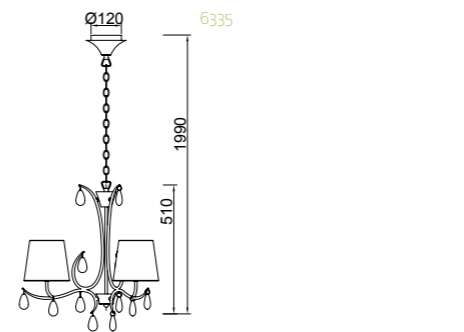
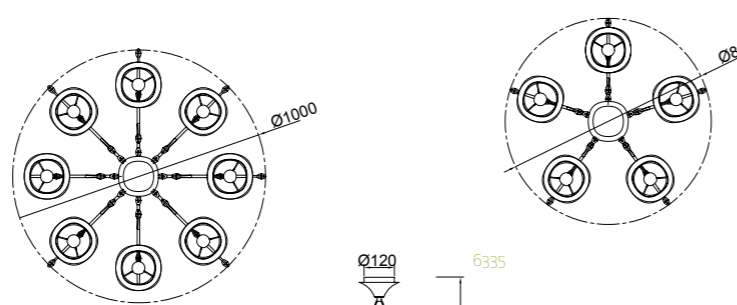
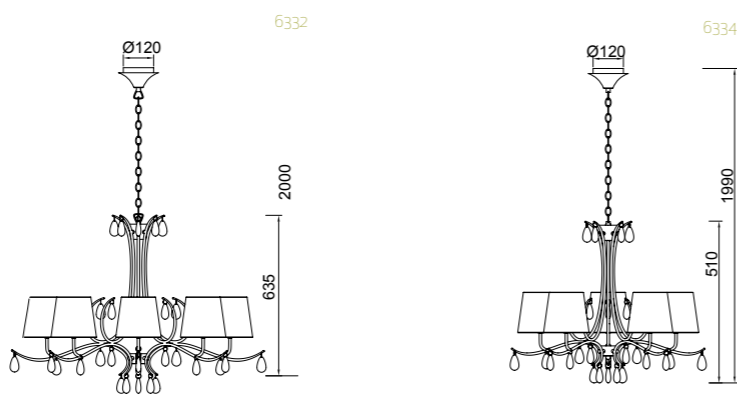
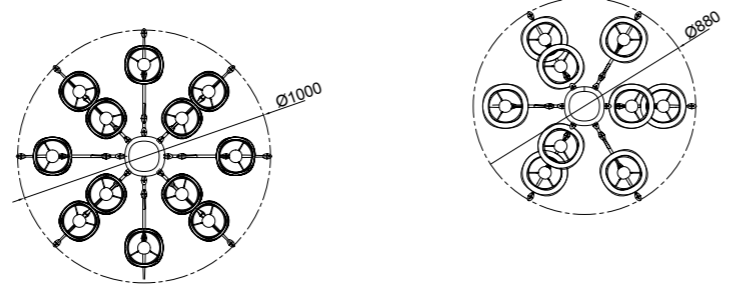
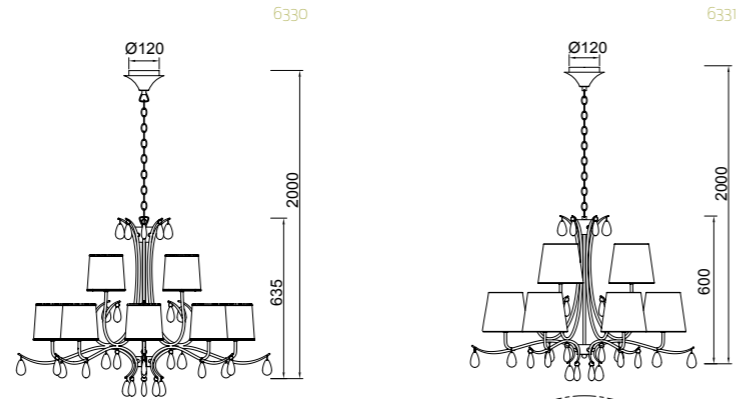



**Sobremesa - Table Lamp**  
Cromo - Chrome

**6318**  
2 x E14 máx.20W/no incl

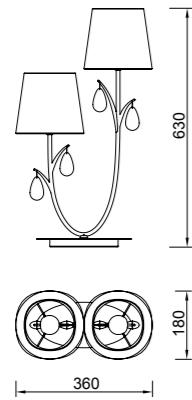

**Sobremesa - Table Lamp**  
Cromo - Chrome

**6319**  
1x E14 máx.20W/no incl  
Clase:II

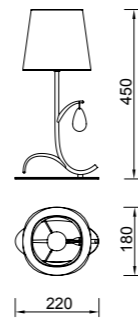
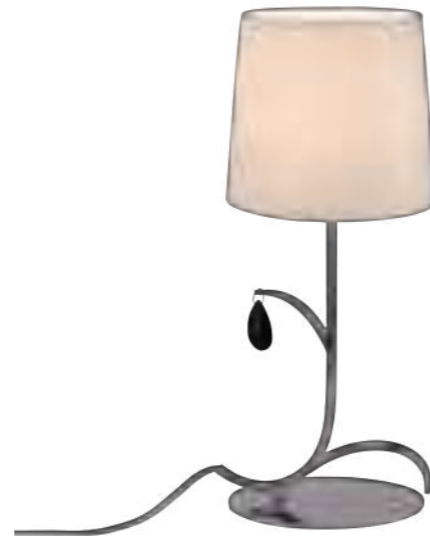

**Aplique - Wall Lamp**  
Cromo - Chrome

**6316**  
2 x E14 máx.20W/no incl

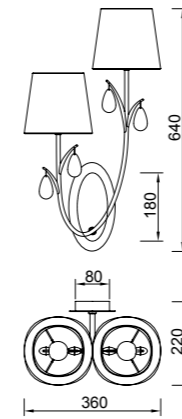

**6317**  
1 x E14 máx.20W/no incl

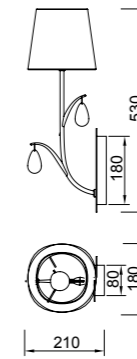

**Pie De Salón - Floor lamp**  
Cromo - Chrome

**6320**  
2 x E27 máx.20W/no incl

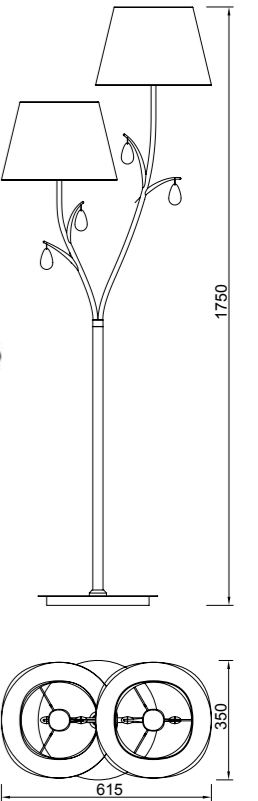
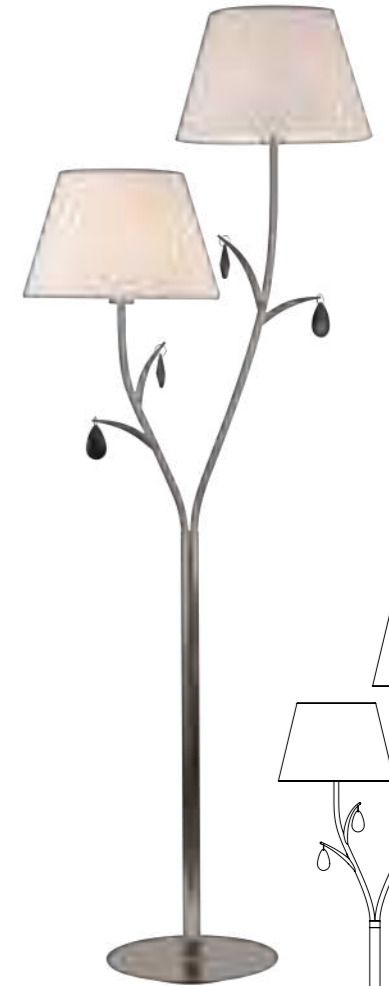

220-240V- 50/60Hz Acero / Madera / Plástico - Steel / Wood / Plastic



220-240V- 50/60Hz Acero / Cristal / Tela - Steel / Glass / Fabric

**Sobremesa - Table Lamp**  
Cuero satinado - *Satin brass*

**6338**  
2 x E14 máx.20W/no incl

**6339**  
1 x E14 máx.20W/no incl

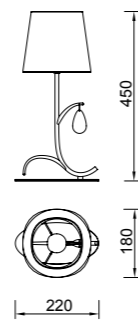
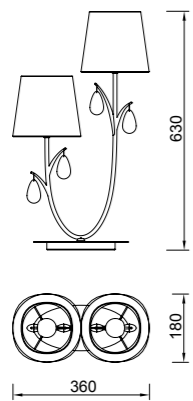

**Aplique - Wall Lamp**  
Cuero satinado - *Satin brass*

**6336**  
2 x E14 máx.20W/no incl

**6337**  
1 x E14 máx.20W/no incl

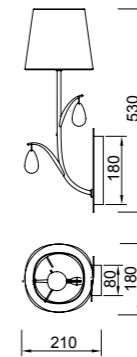
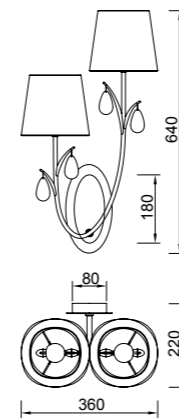

**Pie De Salón - Floor lamp**  
Cuero satinado - *Satin brass*

**6340**  
2 x E27 máx.20W/no incl

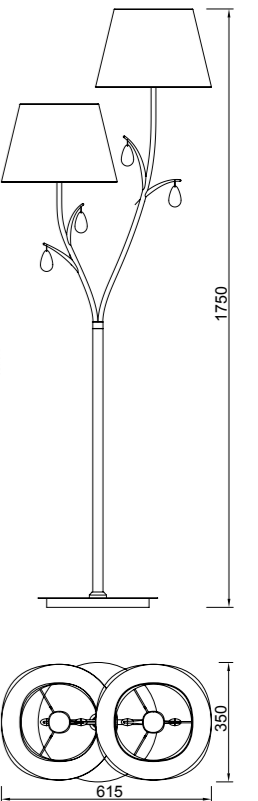

220-240V- 50/60Hz Acero / Madera / Plástico - Steel / Wood / Plastic



220-240V- 50/60Hz Acero / Cristal / Tela - Steel / Glass / Fabric





# Paola

Colección de líneas sofisticadas y elegante.

Con estructuras de metal sinuoso, decoradas en color oro viejo y plata envejecida con pátinas, rematadas con "lágrimas" de cristal en color coñac o negro. De pantallas traslúcidas de algodón, en blanco o negro, que transmiten calidez y luz ambiental. Complementando a PAOLA y cerrando una colección de agradable armonía en su clásico diseño.

*Collection of sophisticated and elegant lines.*

*With sinuous metal structures and decorated in old gold and old silver with patina topped with glass tears in cognac or black color. Translucent shades in cotton, black or white, which transmit warmth and ambient light. Complementing Paola and closing a collection of pleasant harmony in its classic design.*

José Ignacio Ballester



6206

OAMI 004721413 - 022

**Colgante - Pendant Lamp**

Decorado oro - *Decorated gold*  
 Pantalla crema - *Cream shade*  
 Colgantes coñac - *Cognac teardrop glass*

**6205**  
 8 x E14 máx.40W/no incl

**Colgante - Pendant Lamp**

Decorado oro - *Decorated gold*  
 Pantalla crema - *Cream shade*  
 Colgantes coñac - *Cognac teardrop glass*

**6206**  
 5 x E14 máx.40W/no incl

**Colgante - Pendant Lamp**

Decorado plata- *Decorated silver*  
 Pantalla negra - *Black shade*  
 Colgantes negro - *Black teardrop glass*

**6207**  
 8 x E14 máx.40W/no incl

**Colgante - Pendant Lamp**

Decorado plata- *Decorated silver*  
 Pantalla negra - *Black shade*  
 Colgantes negro - *Black teardrop glass*

**6208**  
 5 x E14 máx.40W/no incl

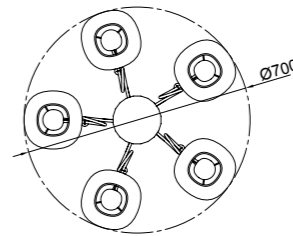
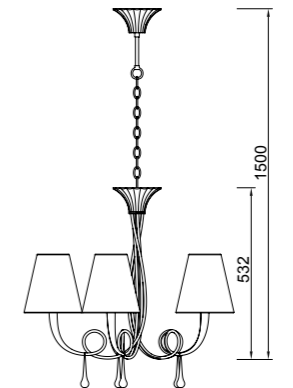
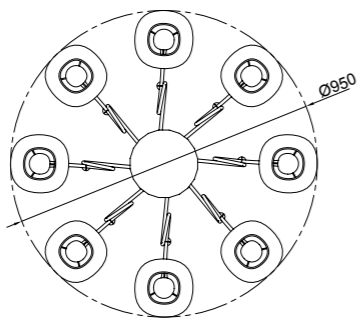
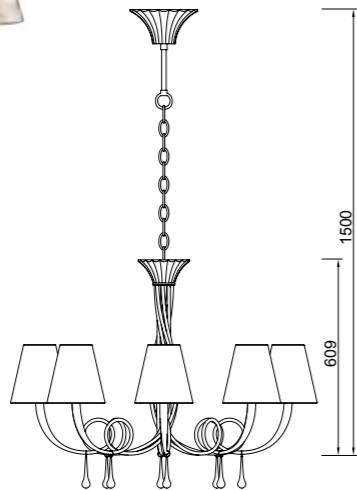



**Colgante - Pendant Lamp**

Pintura Plateada - Silver Painting  
 Pantalla negra - Black shade  
 Colgantes negro - Black teardrop glass

**3530**  
 6 x E14 máx.40W/no incl

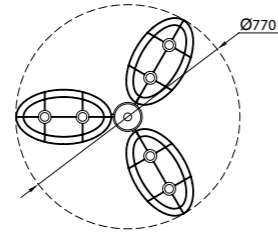
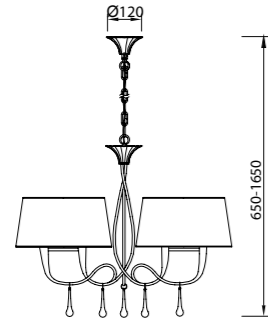

**Colgante - Pendant Lamp**

Pintura Dorada - Gold Painting  
 Pantalla crema - Cream shade  
 Colgantes coñac - Cognac teardrop glass

**3540**  
 6 x E14 máx.40W/no incl

**3531**  
 6 x E14 máx.40W/no incl

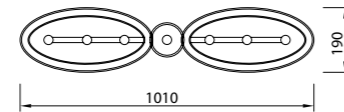
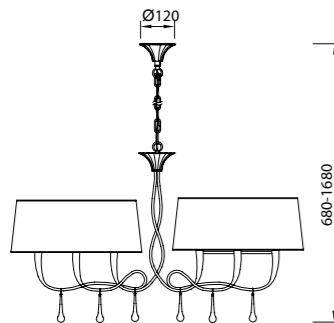

**3541**  
 6 x E14 máx.40W/no incl

**3532**  
 3 x E14 máx.40W/no incl

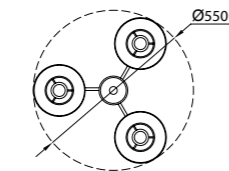
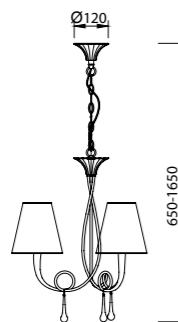

**3542**  
 3 x E14 máx.40W/no incl



220-240V- 50/60Hz Acero / Cristal / Tela - Steel / Glass / Fabric



**Aplique - Wall Lamp**

Pintura Plateada - Silver Painting  
 Pantalla negra - Black shade  
 Colgantes negro - Black teardrop glass

**3537**

2 x E14 máx.40W/no incl  
 Clase:I

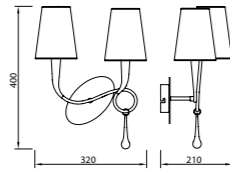
**Aplique - Wall Lamp**

Pintura Dorada- Gold Painting  
 Pantalla crema - Cream shade  
 Colgantes coñac - Cognac teardrop glass

**3547**

2 x E14 máx.40W/no incl  
 Clase:I

**3538**

1 x E14 máx.40W/no incl  
 Clase:I

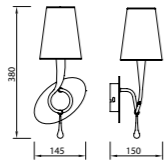
**3548**

1 x E14 máx.40W/no incl  
 Clase:I

**Sobremesa - Table Lamp**

Pintura Plateada - Silver Painting  
 Pantalla negra - Black shade

**3535**

1 x E14 máx.40W/no incl  
 Clase:II

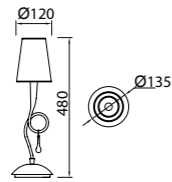
**Sobremesa - Table Lamp**

Pintura Dorada- Gold Painting  
 Pantalla crema - Cream shade

**3545**

1 x E14 máx.40W/no incl  
 Clase:II

**3536**

2 x E14 máx.40W/no incl  
 Clase:I

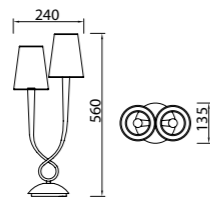
**3546**

2 x E14 máx.40W/no incl  
 Clase:I

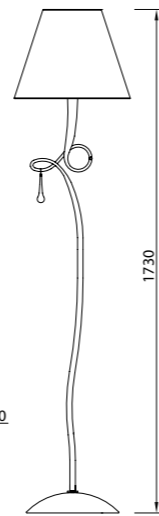
**Pie de salón - Floor Lamp**

Pintura Plateada- Silver Painting  
 Pantalla negra - Black shade

**3533**

1 x E27 máx.60W/no incl  
 Clase:II

**Pie de salón - Floor Lamp**

Pintura Dorada- Gold Painting  
 Pantalla crema - Cream shade

**3543**

1 x E27 máx.60W/no incl  
 Clase:II

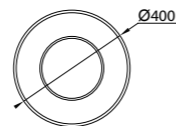

220-240V- 50/60Hz Acero / Madera / Plástico - Steel / Wood / Plastic



3543





# LOEWE

La colección LOEWE con su combinación de líneas suaves y sencillas en sus cuerpos centrales, originales remates de cristal de burbujas, junto con sus pantallas de organza, conforman un elegante conjunto; que transmite una luz ambiental suave a las estancias. Aportando un toque distintivo y sofisticado con sus brillos y transparencias. LOEWE la componen una cuidada selección de lámparas en distintos tamaños y formatos, así como apliques de pared, sobremesas y un pie de salón de original diseño. Piezas que indistintamente se pueden adaptar al más puro ambiente de estilo clásico, o de vanguardia como especial contrapunto.

*LOEWE collection, mixture of gentle and simple stroke in the central body, unique details of bubbled shaped glass with organza shade that makes an entire elegance and transmits a tender light to any spaces. It proves a distinctive and sophisticated look by its sparkle and transparencies. LOEWE is composed series of pendants with different sizes and layouts as well as wall lamp, table lamp and floor lamp that originally designed. They can be adapted to either pure classic style or avant-garde as a special accent. ceiling, wall, table and floor lamps. It is demonstrates to dress your home beautifully ever.*

José Ignacio Ballester



4631

OAMI 002562439-0001 / 002562439-0002 / ZL 201430441270.7 / ZL 201430441007.8







**Lámpara - Pendant Lamp**  
Cromo/Blanco - Chrome/White

**4630**  
9x E14 máx.13W/no incl

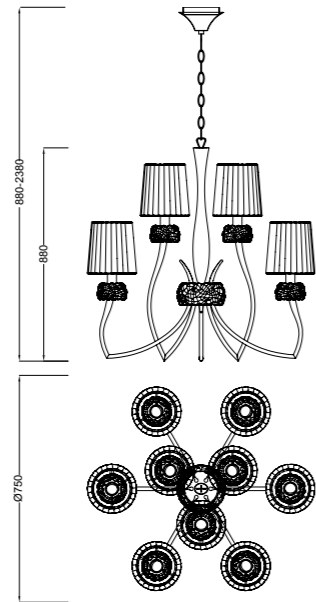

220-240V- 50/60Hz Tela / Acero / Cristal- Tela / Acero / Cristal

**Lámpara - Pendant Lamp**  
Cuero/Blanco - Antique Brass/White

**4730**  
9x E14 máx.13W/no incl



**Lámpara - Pendant Lamp**  
Cromo/Blanco - Chrome/White

**4631**  
5x E14 máx.13W/no incl

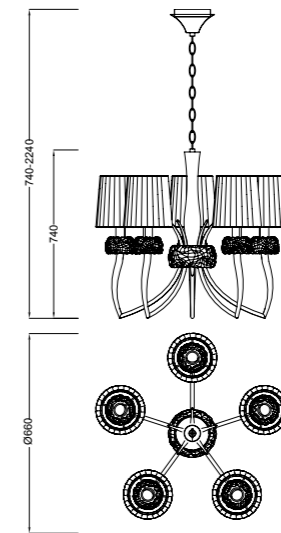

220-240V- 50/60Hz Tela / Acero / Cristal- Tela / Acero / Cristal

**Lámpara - Pendant Lamp**  
Cuero/Blanco - Antique Brass/White

**4731**  
5x E14 máx.13W/no incl



**Lámpara - Pendant Lamp**  
Cromo/Blanco - Chrome/White

**4632**  
5x E14 máx.13W/no incl

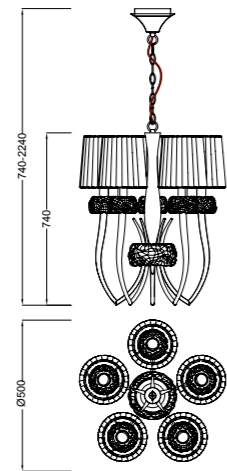

220-240V- 50/60Hz Tela / Acero / Cristal- Tela / Acero / Cristal

**Lámpara - Pendant Lamp**  
Cuero/Blanco - Antique Brass/White

**4732**  
5x E14 máx.13W/no incl



**Lámpara - Pendant Lamp**  
Cromo/Blanco - Chrome/White

**4633**  
3x E14 máx.13W/no incl

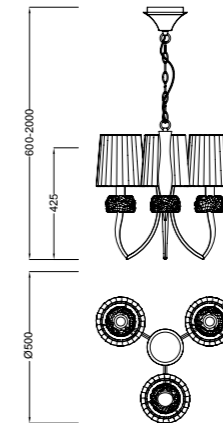

220-240V- 50/60Hz Tela / Acero / Cristal- Tela / Acero / Cristal

**Lámpara - Pendant Lamp**  
Cuero/Blanco - Antique Brass/White

**4733**  
3x E14 máx.13W/no incl





**Plafón - Ceiling Lamp**  
Cromo/Blanco - Chrome/White

**4640**  
3x E27 máx.13W/no incl

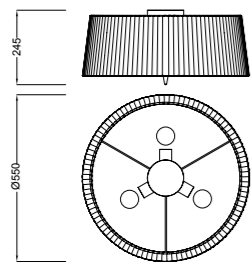

**Plafón - Ceiling Lamp**  
Cuero/Blanco - Antique Brass/White

**4740**  
3x E27 máx.13W/no incl

**Lámpara - Pendant Lamp**  
Cromo/Blanco - Chrome/White

**4639**  
3x E27 máx.13W/no incl



**Lámpara - Pendant Lamp**  
Cuero/Blanco - Antique Brass/White

**4739**  
3x E27 máx.13W/no incl

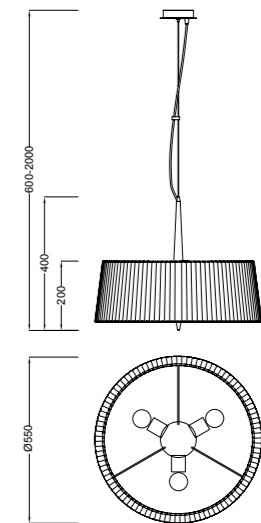

220-240V-50/60Hz Tela / Acero / Cristal- Tela / Acero / Cristal



220-240V-50/60Hz Tela / Acero / Cristal- Tela / Acero / Cristal



**Aplique - Wall Lamp**

Cromo/Blanco - Chrome/White

**4634**

2x E14 máx.13W/no incl

**Aplique - Wall Lamp**

Cuero/Blanco - Antique Brass/White

**4734**

2x E14 máx.13W/no incl

**Aplique - Wall Lamp**

Cromo/Blanco - Chrome/White

**4635**

1x E14 máx.13W/no incl

**Aplique - Wall Lamp**

Cuero/Blanco - Antique Brass/White

**4735**

1x E14 máx.13W/no incl

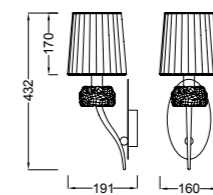
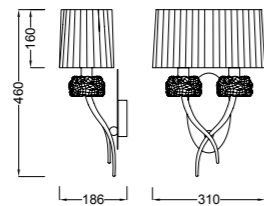



**Sobremesa - Table Lamp**

**4636**  
1x E27 máx.13W/no incl  
Cromo/Blanco - Chrome/White

**4736**  
1x E27 máx.13W/no incl  
Cuero/Blanco - Antique Brass/White

**Sobremesa - Table Lamp**

**4637**  
1x E14 máx.13W/no incl  
Cromo/Blanco - Chrome/White

**4737**  
1x E14 máx.13W/no incl  
Cuero/Blanco - Antique Brass/White

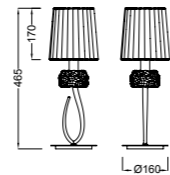
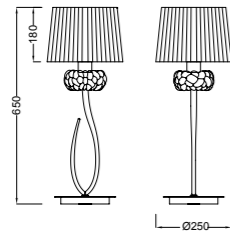

**Pie de Salón - Floor Lamp**  
Cromo/Blanco - Chrome/White

**4638**  
3x E27 máx.13W/no incl

**Pie de Salón - Floor Lamp**  
Cuero/Blanco - Antique Brass/White

**4738**  
3x E27 máx.13W/no incl

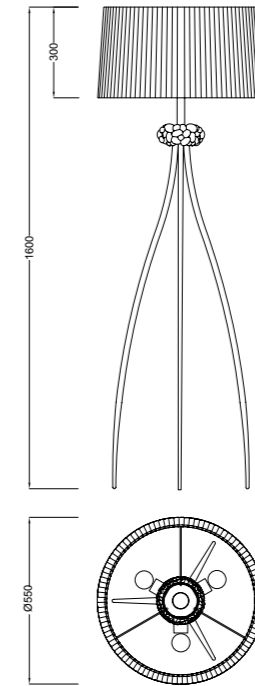

## TIFFANY

Es una elegante colección de iluminación, que transmite y aporta elegancia al lugar dispuesto. Sus transparencias de luz tamizada, junto con los brillos de sus adornos de pedrería de cristal facetado, la hacen sofisticada y eficaz en su función de iluminar decorando. José Ignacio Ballester la creó y diseñó para Mantra buscando una colección ambivalente tanto para grandes espacios, así como para lugares a los que vestir de forma especial. Combina luz E27 o E14 según su diseño y formato, acompañadas estas con G9 en su alojamiento inferior, solución aportada para realzar los brillos de sus tallas de cristal, y a su vez iluminar las superficies donde se proyecta y focaliza su luz. Combinación en sus acabados cromo con pantallas de organza blanca, o en decoración cuero envejecido con pantallas en organza color coñac, son los que visten esta amplia colección compuesta de lámparas colgantes en distintas presentaciones, lámparas lineales, pies de salón, apliques y sobremesas.

*Tiffany is an elegant lighting collection, that transmits elegance to the chosen place. Its sifted light transparencies, along with the sparkles of crystal stones make of this lamp a sophisticated and efficient lighting fixture that illuminates while decorating. José Ignacio Ballester created and designed it for Mantra in the search of an ambivalent collection, both for wide spaces and for places in need of a special atmosphere. It combines E27 and E14 lights, depending on format, accompanied by inner G9 at the inferior part, a solution that enhances the shines of its crystal carvings, as well as illuminating the surfaces where the light is focused. It comes in different finishings, either chrome with shades in white silk fabric, or old leather with cognac color silk fabric. The collection is presented in different fixtures: linear lamp, floor lamp, wall lamp and table lamp.*

José Ignacio Ballester



OAMI 002381905-0001 / 002381905-0002 / ZL 201330587494.4



**Lámpara - Pendant Lamp**  
Cromo/Blanco - Chrome/White

**3850**  
12x E14 máx20W/no incl



**Lámpara - Pendant Lamp**  
Cuero/ coñac - Antique Brass/Soft bronze

**3870**  
12x E14 máx20W/no incl



**Lámpara - Pendant Lamp**  
Cromo/Blanco - Chrome/White

**3851**  
6x E14 máx20W/no incl



**Lámpara - Pendant Lamp**  
Cuero/ coñac - Antique Brass/Soft bronze

**3871**  
6x E14 máx20W/no incl

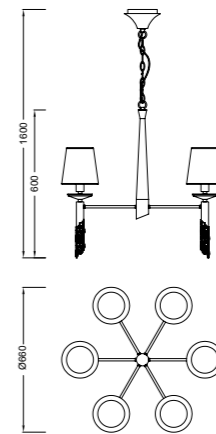
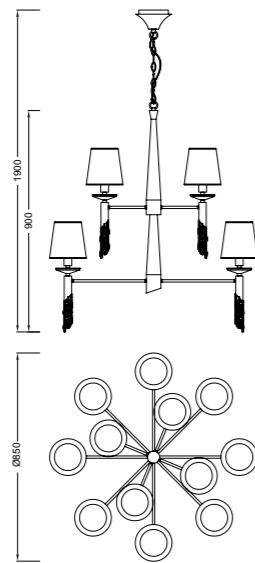

**Lámpara - Pendant Lamp**  
Cromo/Blanco - Chrome/White

**3852**  
4x E14 máx. 20W/no incl

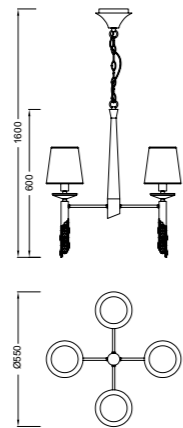

**Lámpara - Pendant Lamp**  
Cuero/ coñac - Antique Brass/Soft bronze

**3872**  
4x E14 máx.20W/no incl



220-240V- 50/60Hz Tela / Acero /Cristal- Tela /Acero /Cristal



**Lámpara - Pendant Lamp**  
Cromo/Blanco - Chrome/White

**3853**  
6x E27 máx.20W/no incl

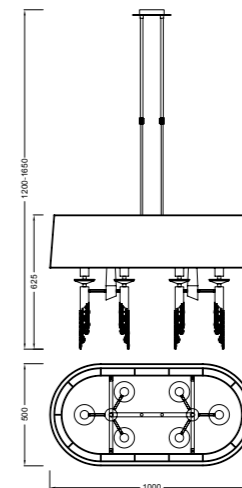

220-240V- 50/60Hz Tela / Acero /Cristal- Tela /Acero /Cristal



**Lámpara - Pendant Lamp**  
Cuero/ coñac - Antique Brass/Soft bronze

**3873**  
6x E27 máx.20W/no incl





**Colgante - Pendant Lamp**

**3858**  
3x E27 máx.20W/no incl  
Cromo/Blanco - Chrome/White

**3878**  
3x E27 máx.20W/no incl  
Cuero/ coñac - Antique Brass/Soft bronze

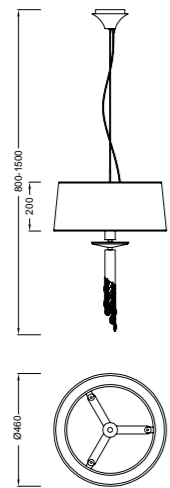

**Colgante - Pendant Lamp**

**3860**  
3x E14 máx.20W/no incl  
Cromo/Blanco - Chrome/White

**3880**  
3x E14 máx.20W/no incl  
Cuero/ coñac - Antique Brass/Soft bronze

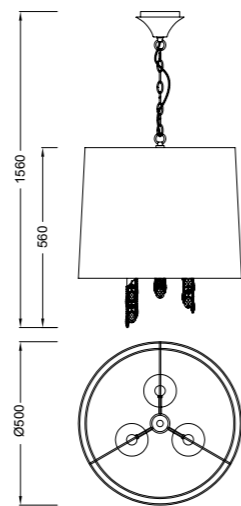

220-240V- 50/60Hz Tela / Acero / Cristal- Tela / Acero / Cristal





**Colgante - Pendant Lamp**  
Cromo/Blanco - Chrome/White

**3861**  
1x E27 máx.20W/no incl

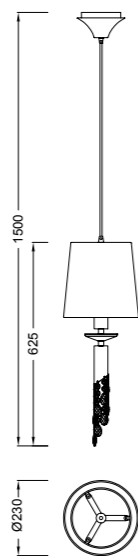

220-240V-50/60Hz Tela / Acero / Cristal- Tela / Acero / Cristal

**Colgante - Pendant Lamp**  
Cuero/ coñac - Antique Brass/Soft bronze

**3881**  
1x E27 máx.20W/no incl





**Lámpara - Pendant Lamp**  
Cromo/Blanco - Chrome/White

**3855**  
3x E27 máx.20W/no incl



**Lámpara - Pendant Lamp**  
Cuero/ coñac - Antique Brass/Soft bronze

**3875**  
3x E27 máx.20W/no incl

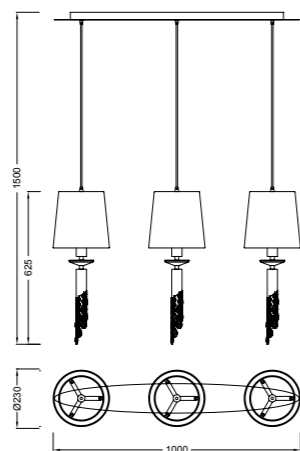

220-240V- 50/60Hz Tela / Acero / Cristal- Tela / Acero / Cristal



**Aplique - Wall Lamp**

**3863**  
2x E14 máx.20W/no incl  
Cromo/Blanco - Chrome/White

**3883**  
2x E14 máx.20W/no incl  
Cuero/ coñac - Antique Brass/Soft bronze

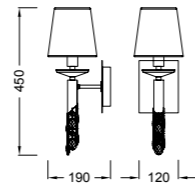
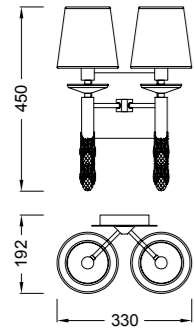

**Aplique - Wall Lamp**

**3864**  
1x E14 máx.20W/no incl  
Cromo/Blanco - Chrome/White

**3884**  
1x E14 máx.20W/no incl  
Cuero/ coñac - Antique Brass/Soft bronze

**Lámpara - Pendant Lamp**  
Cromo/Blanco - Chrome/White

**3857**  
5x E27 máx.20W/no incl

**Lámpara - Pendant Lamp**  
Cuero/ coñac - Antique Brass/Soft bronze

**3877**  
5x E27 máx.20W/no incl

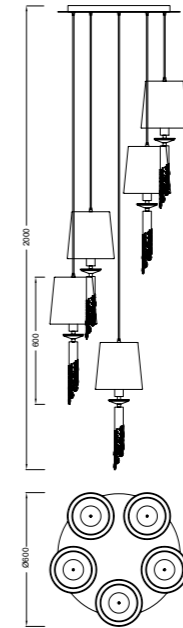



**Sobremesa - Table Lamp**  
Cromo/Blanco - Chrome/White

**3868**  
1x E14 máx.20W/no incl

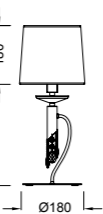

**Sobremesa - Table Lamp**  
Cuero/ coñac - Antique Brass/Soft bronze

**3888**  
1x E14 máx.20W/no incl



**Pie De Salón - Floor Lamp**  
Cromo/Blanco - Chrome/White

**3869**  
3x E27 máx.13W/no incl

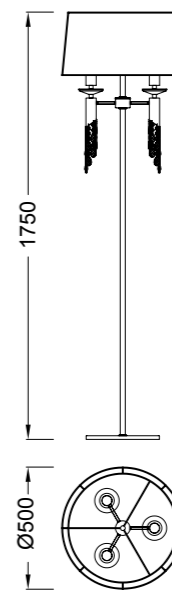

**Pie De Salón - Floor Lamp**  
Cuero/ coñac - Antique Brass/Soft bronze

**3889**  
3x E27 máx.13W/no incl



220-240V- 50/60Hz Tela / Acero / Cristal- Tela / Acero / Cristal



220-240V- 50/60Hz Tela / Acero / Cristal- Tela / Acero / Cristal

## EVE

El diseñador J. I. Ballester crea para Mantra... EVE. Propuesta sencilla, escueta y elegante de iluminación, tal vez romántica. De trazos limpios, coronada con unas pantallas circulares y ovales, que conforman elementos de iluminación con personalidad propia. La colección la componen lámparas, lineales, plafones, colgantes, Auxiliares con diversas adaptaciones y pié de salón. De tal manera son tan simples y suaves sus líneas que Mantra a dispuesto la presentación de la colección en dos acabados que armonizan efectivamente con sus pantallas. Son el acabado cromo, (con pantallas negro y crudo) y el gris antracita (pantallas en crudo). Permitiendo estas opciones que se puedan ubicar las piezas de la colección tanto en ambientes modernos, como también en espacios sofisticados y elegantes. Por su proporción de pantallas esta pensada para albergar el bajo consumo discretamente, siendo pues otro aliciente más de EVE, a tener en cuenta para formar parte de

*The designer, J. I. Ballester has designed a special collection for Mantra... EVE. An elegantly simple proposal, with a slight romantic touch. With clean lines, crowned with circular and oval shades which comprise lighting elements with their own personality. The collection is comprised by lamps, linear models, ceiling and hanging lamps, Auxiliary lamps with diverse adaptations and floor lamp. Their lines are so simple and smooth that Mantra has presented the collection in two finishes which evenly match their shades. They are chrome finish, (with black and natural shades) and grey coal (shades in natural colour). These options permit the placement of these collection's items in modern atmospheres as well as sophisticated elegant spaces. Based on their shade proportions, they are designed to discretely house low-consumption light, which makes EVE even more appealing as a lighting option for your home.*

José Ignacio Ballester



OAMI 001698267-0003 / 001698267-0005 / 001698267-0002 / 001698267-0006 / 001698267-0004 ZL 201030215080.5 / ZL 201030215081.X / ZL 201030215082.4 / ZL 201030215085.8 / ZL 201030215128.2

1133



**Lámpara - Pendant Lamp**

Cromo - Chrome  
Pantalla blanco roto - Off white shade

**1131**  
3x E27máx.20W/no incl



**Lámpara - Pendant Lamp**

Cromo - Chrome  
Pantalla negra - black Shade

**1171**  
3x E27máx.20W/no incl



**Colgante - Pendant Lamp**

Cromo - Chrome  
Pantalla negra - black Shade

**1173**  
3x E27máx.20W/no incl



**Colgante - Pendant Lamp**

Cromo - Chrome  
Pantalla blanco roto - Off white shade

**1133**  
3x E27máx.20W/no incl



**Lámpara - Pendant Lamp**

Antracita - Anthracite  
Pantalla blanco roto - Off white shade

**1151**  
3x E27máx.20W/no incl

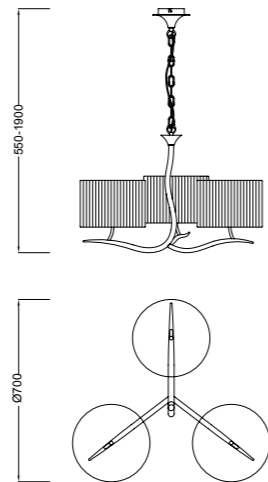

**Colgante - Pendant Lamp**

Antracita - Anthracite  
Pantalla blanco roto - Off white shade

**1153**  
3x E27máx.20W/no incl

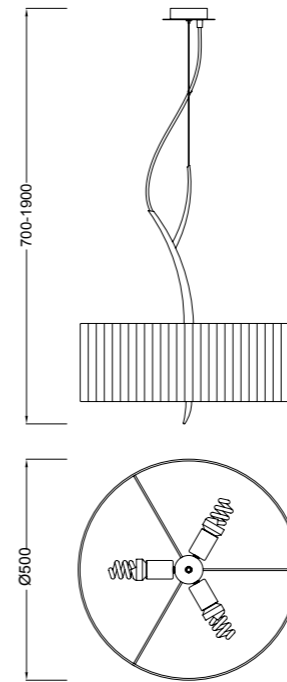

**Lámpara - Pendant Lamp**

Cromo - Chrome  
Pantalla blanco roto - Off white shade

**1130**  
4x E27máx.20W/no incl



**Lámpara - Pendant Lamp**

Cromo - Chrome  
Pantalla negra - black Shade

**1170**  
4x E27máx.20W/no incl



**Lámpara - Pendant Lamp**

Antracita - Anthracite  
Pantalla blanco roto - Off white shade

**1150**  
4x E27máx.20W/no incl

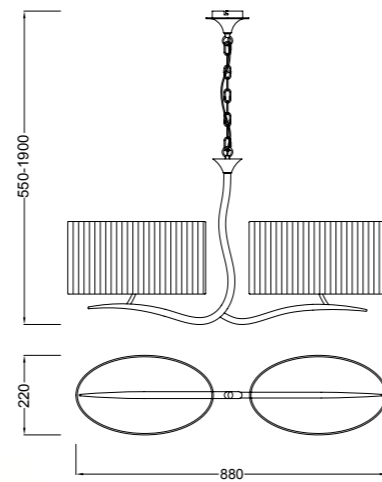



**Semi Plafón - Semi-Ceiling Lamp**

Cromo - Chrome  
Pantalla blanco roto - Off white shade

**1132**  
2x E27máx.20W/no incl



**Semi Plafón - Semi-Ceiling Lamp**

Cromo - Chrome  
Pantalla negra - black Shade

**1172**  
2x E27máx.20W/no incl



**Sobremesa - Table Lamp**

Antracita - Anthracite  
Pantalla blanco roto - Off white shade

**1157**  
2x E27máx.20W/no incl

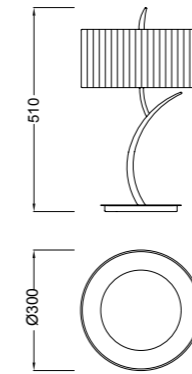

**Sobremesa - Table Lamp**

Cromo - Chrome  
Pantalla blanco roto - Off white shade

**1137**  
2x E27 máx.20W/no incl



**Sobremesa - Table Lamp**

Cromo - Chrome  
Pantalla negra - black Shade

**1177**  
2x E27 máx.20W/no incl



**Semi Plafón - Semi-Ceiling Lamp**

Antracita - Anthracite  
Pantalla blanco roto - Off white shade

**1152**  
2x E27máx.20W/no incl

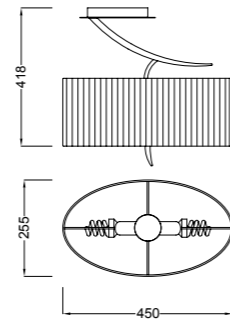

220-240V- 50/60Hz Acero /Cristal /Tela - Steel /Glass /Fabric



220-240V- 50/60Hz Acero /Cristal /Tela - Steel /Glass /Fabric

**Sobremesa - Table Lamp**

Cromo - Chrome  
Pantalla blanco roto - Off white shade

**1138**  
2x E27máx.20W/no incl



**Sobremesa - Table Lamp**

Cromo - Chrome  
Pantalla negra - black Shade

**1178**  
2x E27máx.20W/no incl



**Sobremesa - Table Lamp**

Antracita - Anthracite  
Pantalla blanco roto - Off white shade

**1158**  
2x E27máx.20W/no incl

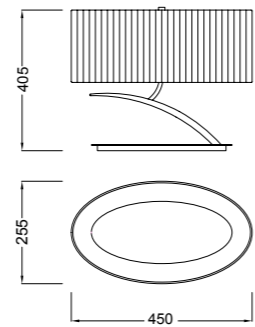



**Aplique - Wall Lamp**

Cromo - Chrome  
Pantalla blanco roto - Off white shade

**1136**  
3x E27máx.20W/no incl



**Aplique - Wall Lamp**

Cromo - Chrome  
Pantalla negra - black Shade

**1176**  
3x E27máx.20W/no incl



**Aplique - Wall Lamp**

Antracita - Anthracite  
Pantalla blanco roto - Off white shade

**1156**  
3x E27máx.20W/no incl

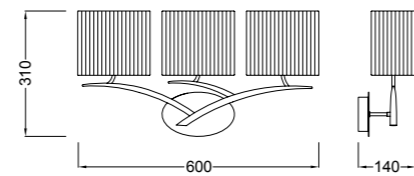

**Aplique - WallLamp**

Cromo - Chrome  
Pantalla blanco roto - Off white shade

**1134**  
1x E27máx.20W/no incl



**Aplique - WallLamp**

Cromo - Chrome  
Pantalla negra - black Shade

**1174**  
1x E27máx.20W/no incl



**Aplique - WallLamp**

Antracita - Anthracite  
Pantalla blanco roto - Off white shade

**1155**  
2x E27máx.20W/no incl

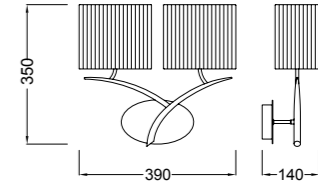

**Aplique - WallLamp**

Cromo - Chrome  
Pantalla blanco roto - Off white shade

**1135**  
2x E27 máx.20W/no incl



**Aplique - WallLamp**

Cromo - Chrome  
Pantalla negra - black Shade

**1175**  
2x E27 máx.20W/no incl



**Aplique - WallLamp**

Antracita - Anthracite  
Pantalla blanco roto - Off white shade

**1154**  
1x E27máx.20W/no incl

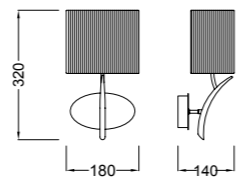

220-240V- 50/60Hz Acero /Cristal /Tela - Steel /Glass /Fabric



220-240V- 50/60Hz Acero /Cristal /Tela - Steel /Glass /Fabric



**Pie De Sal3n - Floor Lamp**

Antracita - Anthracite  
Pantalla blanco roto - Off white shade

**1159**  
2x E27m3x.20W/no incl

**Pie De Sal3n - Floor Lamp**

Cromo - Chrome  
Pantalla negra - black Shade

**1179**  
2x E27m3x.20W/no incl

**Pie De Sal3n - Floor Lamp**

Cromo - Chrome  
Pantalla blanco roto - Off white shade

**1139**  
2x E27m3x.20W/no incl



220-240V- 50/60Hz Acero / Cristal / Tela - Steel / Glass / Fabric



## LUA

Simplicidad, líneas depuradas y escuetas definen la colección LUA. José I. Ballester con trazos de movimiento envolvente crea, para Mantra, esta colección de iluminación, romántica y elegante, combinando pantallas y metal. Todos sus elementos nacen de un solo trazo, una sola línea que conforman su estructura, sobre la cual se disponen los puntos de luz. La belleza de su lámpara lineal solo se ve igualada, con el especial diseño de su lámpara circular, siendo estos sus más peculiares elementos y que son acompañados por colgantes, plafones, sobremesas y apliques en varios tamaños y un espectacular pie de salón. La colección adapta luz E27, preparada pues perfectamente al bajo consumo. Y se presenta en combinación de dos acabados. Níquel satinado con pantallas plisadas en blanco, lo que le otorga un aire sofisticado, y una segunda combinación, decorando las estructuras en color gris ceniza y sus pantallas lisas a juego, aportando un aire más nórdico. LUA pues... es la perfecta combinación de elegancia y simplicidad que estabas buscando para ese lugar de tu hogar.

*Simplicity, succinct and refined lines define the LUA collection. José I. Ballester, with strokes of enveloping movement, created this romantic and elegant collection, combining fabric shade and metal. All elements are born by a single stroke, only one line that makes its structure on which are placed the light points. The beauty of its lineal lamp only looks even, compared the special design of the circular lamp, being the most peculiar elements and it is accompanied by pendants, ceiling, table lamps and wall lamp in various sizes and also a spectacular floor lamp. The collection utilizes E27 lamp, prepared therefore perfectly for energy saving bulbs. It is offered with combination of two finishes. Nickel Satin with pleated white shade which gives a sophisticated atmosphere, and another combination decorating the structures in ash-grey finish comes with plain shade, providing rather Nordic taste. LUA... is the perfect combination of elegance and simplicity that you have been looking for "that place" in your home.*

José Ignacio Ballester



3700

OAMI 002237214-0004 / 002237214-0005 / 002237214-0006 / ZL 201230663290.X / ZL 201230663468.0 / ZL 201330237190.5



**Colgante - Pendant Lamp**

Gris Ceniza - Ash Grey  
Pantalla Gris ceniza - Ash Grey

**3684**  
3x E27máx.20W/no incl



**Colgante - Pendant Lamp**

Níquel Satinado - Satin Nickel  
Pantalla blanco roto - Fabric White

**3704**  
3x E27máx.20W/no incl

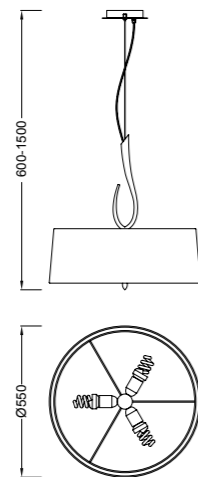

220-240V- 50/60Hz Acero/Tela - Steel/Fabric

**Lámpara - Pendant Lamp**

Gris Ceniza - Ash Grey  
Pantalla Gris ceniza - Ash Grey

**3680**  
4x E27máx.20W/no incl



**Lámpara - Pendant Lamp**

Níquel Satinado - Satin Nickel  
Pantalla blanco roto - Fabric White

**3700**  
4x E27máx.20W/no incl

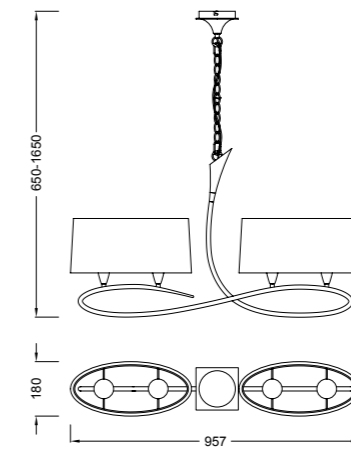

220-240V- 50/60Hz Acero/Tela - Steel/Fabric



**Lámpara - Pendant Lamp**

Gris Ceniza - Ash Grey  
Pantalla Gris ceniza - Ash Grey

**3686**  
3x E27máx.20W/no incl



**Lámpara - Pendant Lamp**

Níquel Satinado - Satin Nickel  
Pantalla blanco roto - Fabric White

**3706**  
3x E27máx.20W/no incl

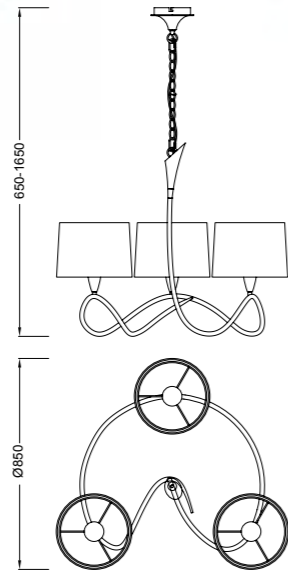

220-240V - 50/60Hz Acero / Tela - Steel / Fabric





**Plafón - Ceiling Lamp**

Gris Ceniza - Ash Grey  
Tela / Gris ceniza + Cristal / Arena  
Fabric / Ash Grey + Glass / Sand

**3685**  
3x E27máx.20W/no incl



**Plafón - Ceiling Lamp**

Níquel Satinado - Satin Nickel  
Tela / Blanco +Cristal / Arena  
Fabric / White + Glass / Sand

**3705**  
3x E27máx.20W/no incl



**Semi-Plafón - Ceiling Lamp**

Gris Ceniza - Ash Grey  
Tela / Gris ceniza +Cristal / Arena  
Fabric / Ash Grey + Glass / Sand

**3690**  
2x E27máx.20W/no incl



**Semi-Plafón - Ceiling Lamp**

Níquel Satinado - Satin Nickel  
Tela / Blanco +Cristal / Arena  
Fabric / White + Glass / Sand

**3710**  
2x E27máx.20W/no incl



220-240V- 50/60Hz Acero /Cristal /Tela - Steel /Glass /Fabric



**Aplique - Wall Lamp**

Níquel Satinado - *Satin Nickel*  
 Pantalla blanco roto - *Fabric White*

**3707**

2x E27máx.20W/no incl

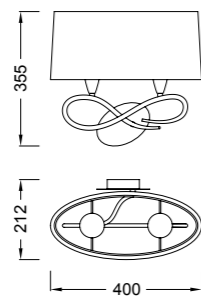

**Aplique - Wall Lamp**

Gris Ceniza - *Ash Grey*  
 Pantalla Gris ceniza - *Ash Grey*

**3687**

2x E27máx.20W/no incl



**Aplique - Wall Lamp**

Níquel Satinado - *Satin Nickel*  
 Pantalla blanco roto - *Fabric White*

**3701**

1x E27máx.20W/no incl

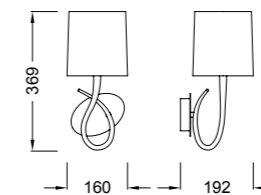

**Aplique - Wall Lamp**

Gris Ceniza - *Ash Grey*  
 Pantalla Gris ceniza - *Ash Grey*

**3681**

1x E27máx.20W/no incl



220-240V- 50/60Hz Acero /Tela - Steel /Fabric



220-240V- 50/60Hz Acero /Tela - Steel /Fabric



**Sobremesa - Table Lamp**  
 Níquel Satinado - *Satin Nickel*  
 Pantalla blanco roto - *Fabric White*

**3702**  
 1x E27máx.20W/no incl



**Sobremesa - Table Lamp**  
 Gris Ceniza - *Ash Grey*  
 Pantalla Gris ceniza - *Ash Grey*

**3682**  
 1x E27máx.20W/no incl

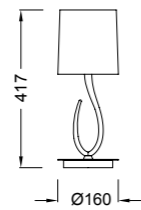

**Sobremesa - Table Lamp**  
 Níquel Satinado - *Satin Nickel*  
 Pantalla blanco roto - *Fabric White*

**3708**  
 1x E27máx.20W/no incl



**Sobremesa - Table Lamp**  
 Gris Ceniza - *Ash Grey*  
 Pantalla Gris ceniza - *Ash Grey*

**3688**  
 1x E27máx.20W/no incl

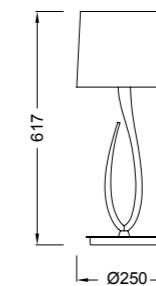

220-240V- 50/60Hz Acero / Tela - Steel / Fabric



220-240V- 50/60Hz Acero / Tela - Steel / Fabric

**Sobremesa - Table Lamp**  
 Níquel Satinado - *Satin Nickel*  
 Pantalla blanco roto - *Fabric White*

**3703**  
 2x E27máx.20W/no incl

**Sobremesa - Table Lamp**  
 Gris Ceniza - *Ash Grey*  
 Pantalla Gris ceniza - *Ash Grey*

**3683**  
 2x E27máx.20W/no incl

**Pie De Salón - Floor Lamp**  
 Níquel Satinado - *Satin Nickel*  
 Pantalla blanco roto - *Fabric White*

**3709**  
 2x E27máx.20W/no incl

**Pie De Salón - Floor Lamp**  
 Gris Ceniza - *Ash Grey*  
 Pantalla Gris ceniza - *Ash Grey*

**3689**  
 2x E27máx.20W/no incl

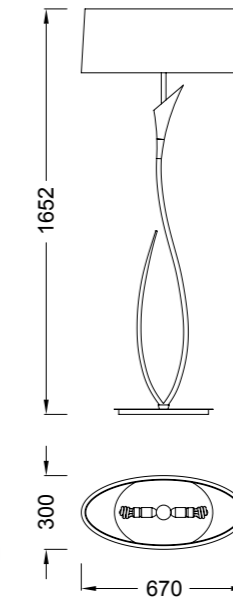
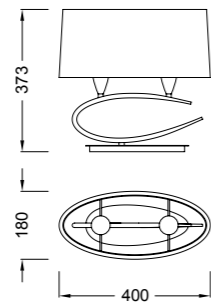

220-240V- 50/60Hz Acero / Tela - Steel / Fabric



220-240V- 50/60Hz Acero / Tela - Steel / Fabric



## NINETTE

Ninette, es el nombre que da título a esta romántica colección de iluminación, simple y sucinta, propuesta por José Ignacio Ballester para Mantra. Breves trazos inacabados arman las estructuras de sus elementos, las livianas líneas de sus armazones sintonizan con el movimiento que aportan sus originales pantallas. Armonizando un bello conjunto conformado por lámparas colgantes, lámparas lineales, ... plafones, semi-plafones y otros elementos de iluminación como apliques de pared, sobremesas y un estilizado pié de salón. La colección perfectamente puede albergar luz de bajo consumo, siendo el acabado de su metal en baño de cromo o acabado cuero. Sus pantallas podrán ser en blanco o negro según su elección. Así pues Ninette, no puede pasar inadvertido a su gusto, si desea dotar de elegancia y distinción a esa estancia que usted pretende vestir, con cualquiera de estos bellos elementos de iluminación.

*Ninette is the name of this gracefully streamlined romantic lighting collection proposed by José Ignacio Ballester for Mantra. Brief unfinished lines frame the structures of its elements as the elegance of its lightweight frames move in harmony with its original shades. A harmoniously beautiful set comprised by hanging lamps, linear lamps, ceiling and semi-ceiling lamps, and other lighting elements such as wall lamps and table lamps as well as a stylish floor lamp. The collection perfectly houses low-consumption light and its metal finish is available in chrome plate or leather finish. Their shades can be black or white according to your choice. Thus, Ninette is an outstanding example of good taste if you wish to decorate your room with an elegant sophisticated style with any of the beautiful lighting elements of this collection.*

José Ignacio Ballester



OAMI 002054213-0020 / 002054213-0019 / 002054213-0017 / 002054213-0018 / 002054213-0021

Lámpara- Pendant Lamp

**1901** Cromo - Chrome  
 Pantalla blanco roto - Off white shade  
 4x E14 máx.20W/no incl

**1911** Cromo - Chrome  
 Pantalla negra - Black shade  
 4x E14 máx.20W/no incl

**1921** Cuero - Antique brass  
 Pantalla blanco roto - Off white shade  
 4x E14 máx.20W/no incl

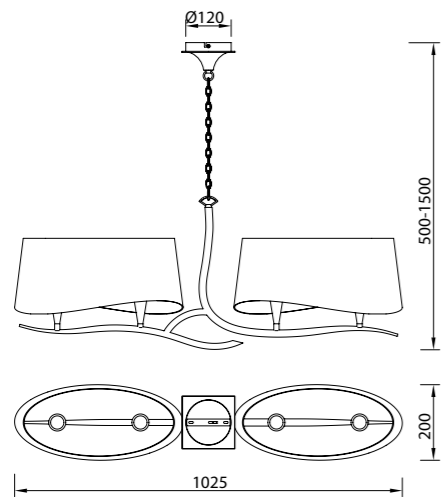

Colgante - Pendant Lamp

**1902** Cromo - Chrome  
 Pantalla blanco roto - Off white shade  
 4x E27 máx.20W/no incl

**1912** Cromo - Chrome  
 Pantalla negra - Black shade  
 4x E27 máx.20W/no incl

**1922** Cuero - Antique brass  
 Pantalla blanco roto - Off white shade  
 4x E27 máx.20W/no incl

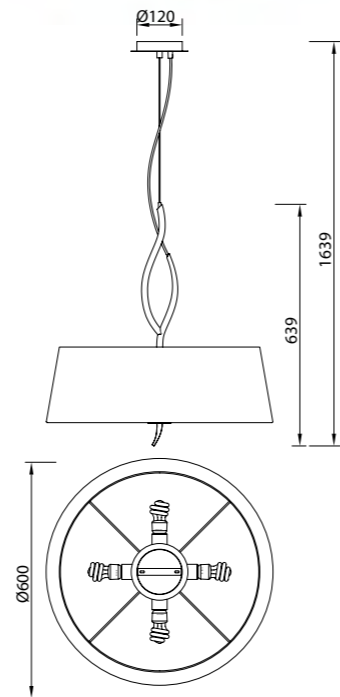

Lámpara- Pendant Lamp

**1900** Cromo - Chrome  
 Pantalla blanco roto - Off white shade  
 6x E14 máx.20W/no incl

**1910** Cromo - Chrome  
 Pantalla negra - Black shade  
 6x E14 máx.20W/no incl

**1920** Cuero - Antique brass  
 Pantalla blanco roto - Off white shade  
 6x E14 máx.20W/no incl

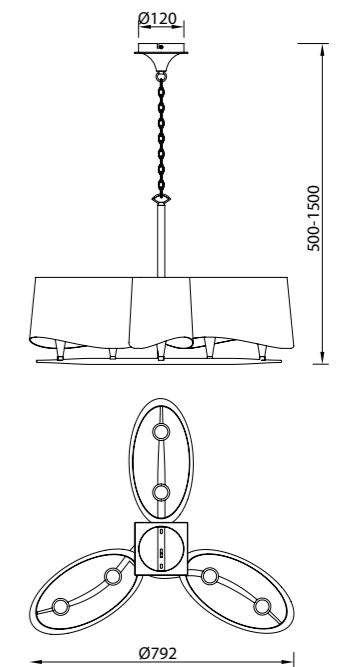

220-240V- 50/60Hz Acero /Tela - Steel /Fabric



220-240V- 50/60Hz Acero /Tela - Steel /Fabric



**Aplique - Wall Lamp**

**1903** Cromo - Chrome  
 Pantalla blanco roto - Off white shade  
 2x E14 máx.20W/no incl

**1913** Cromo - Chrome  
 Pantalla negra - Black shade  
 2x E14 máx.20W/no incl

**1923** Cuero - Antique brass  
 Pantalla blanco roto - Off white shade  
 2x E14 máx.20W/no incl

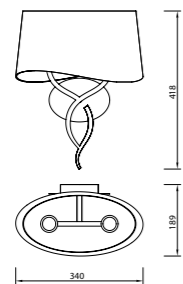

**Aplique - Wall Lamp**

**1904** Cromo - Chrome  
 Pantalla blanco roto - Off white shade  
 1x E14 máx.20W/no incl

**1914** Cromo - Chrome  
 Pantalla negra - Black shade  
 1x E14 máx.20W/no incl

**1924** Cuero - Antique brass  
 Pantalla blanco roto - Off white shade  
 1x E14 máx.20W/no incl

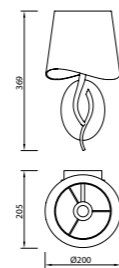

**Plafón - Ceiling Lamp**

**1909** Cromo - Chrome  
 Pantalla blanco roto - Off white shade  
 Cristal / Arena - Glass / Sand  
 4x E27 máx.20W/no incl

**1919** Cromo - Chrome  
 Pantalla negra - Black shade  
 Cristal / Arena - Glass / Sand  
 4x E27 máx.20W/no incl

**1929** Cuero - Antique brass  
 Pantalla blanco roto - Off white shade  
 Tela / Blanco + Cristal / Arena  
 4x E27 máx.20W/no incl

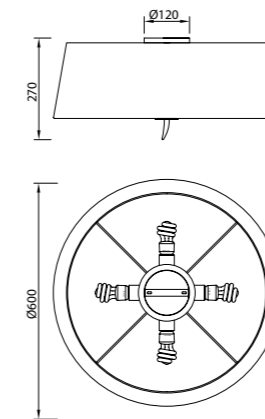

**Semi Plafón - Semi ceiling Lamp**

**1908** Cromo - Chrome  
 Pantalla blanco roto - Off white shade  
 Cristal / Arena - Glass / Sand  
 4x E27 máx.20W/no incl

**1918** Cromo - Chrome  
 Pantalla negra - Black shade  
 Cristal / Arena - Glass / Sand  
 4x E27 máx.20W/no incl

**1928** Cuero - Antique brass  
 Pantalla blanco roto - Off white shade  
 Cristal / Arena - Glass / Sand  
 4x E27 máx.20W/no incl

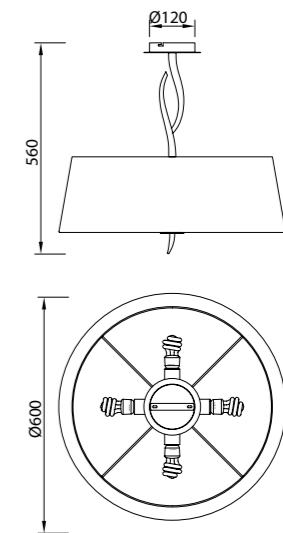

**Sobremesa - Table Lamp**

**1906** Cromo - Chrome  
 Pantalla blanco roto - Off white shade  
 2x E14 máx.20W/no incl

**1916** Cromo - Chrome  
 Pantalla negra - Black shade  
 2x E14 máx.20W/no incl

**1926** Cuero - Antique brass  
 Pantalla blanco roto - Off white shade  
 2x E14 máx.20W/no incl

**Sobremesa - Table Lamp**

**1905** Cromo - Chrome  
 Pantalla blanco roto - Off white shade  
 1x E14 máx.20W/no incl

**1915** Cromo - Chrome  
 Pantalla negra - Black shade  
 1x E14 máx.20W/no incl

**1925** Cuero - Antique brass  
 Pantalla blanco roto - Off white shade  
 1x E14 máx.20W/no incl

**Pie de salón - Floor Lamp**

**1907** Cromo - Chrome  
 Pantalla blanco roto - Off white shade  
 4x E27 máx.20W/no incl

**1917** Cromo - Chrome  
 Pantalla negra - Black shade  
 4x E27 máx.20W/no incl

**1927** Cuero - Antique brass  
 Pantalla blanco roto - Off white shade  
 4x E27 máx.20W/no incl

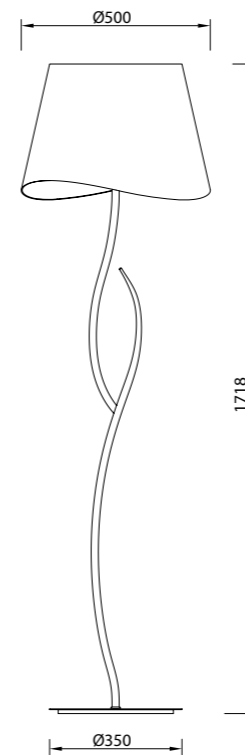
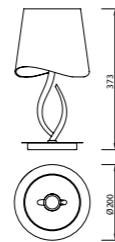
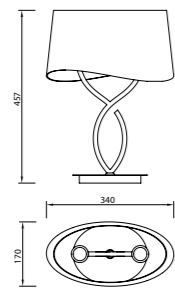

220-240V- 50/60Hz Acero / Tela - Steel / Fabric



220-240V- 50/60Hz Acero / Tela - Steel / Fabric



## MARA

MARA es una colección de formas elegantes y sencillas creada por Jose Ignacio Ballester, que entrelazan y giran sus perfiles cónicos generando estructuras tridimensionales de movimiento visual. Aporta una serie de detalles peculiares de cristal, junto con unos enfilajes y pantallas de formato distinto, presentan en acabado cromo brillo y en cuero. los colores de pantallas, crema o negro, en plisado americano.

*MARA is a collection of elegantly simple forms created by Jose Ignacio Ballester, whose conical frames intertwine and rotate to generate three-dimensional structures of visual movement. It has a bright chrome or leather finish, which we call "chocolate". Both finishes can be combined with cream or black shades in American pleating.*

José Ignacio Ballester

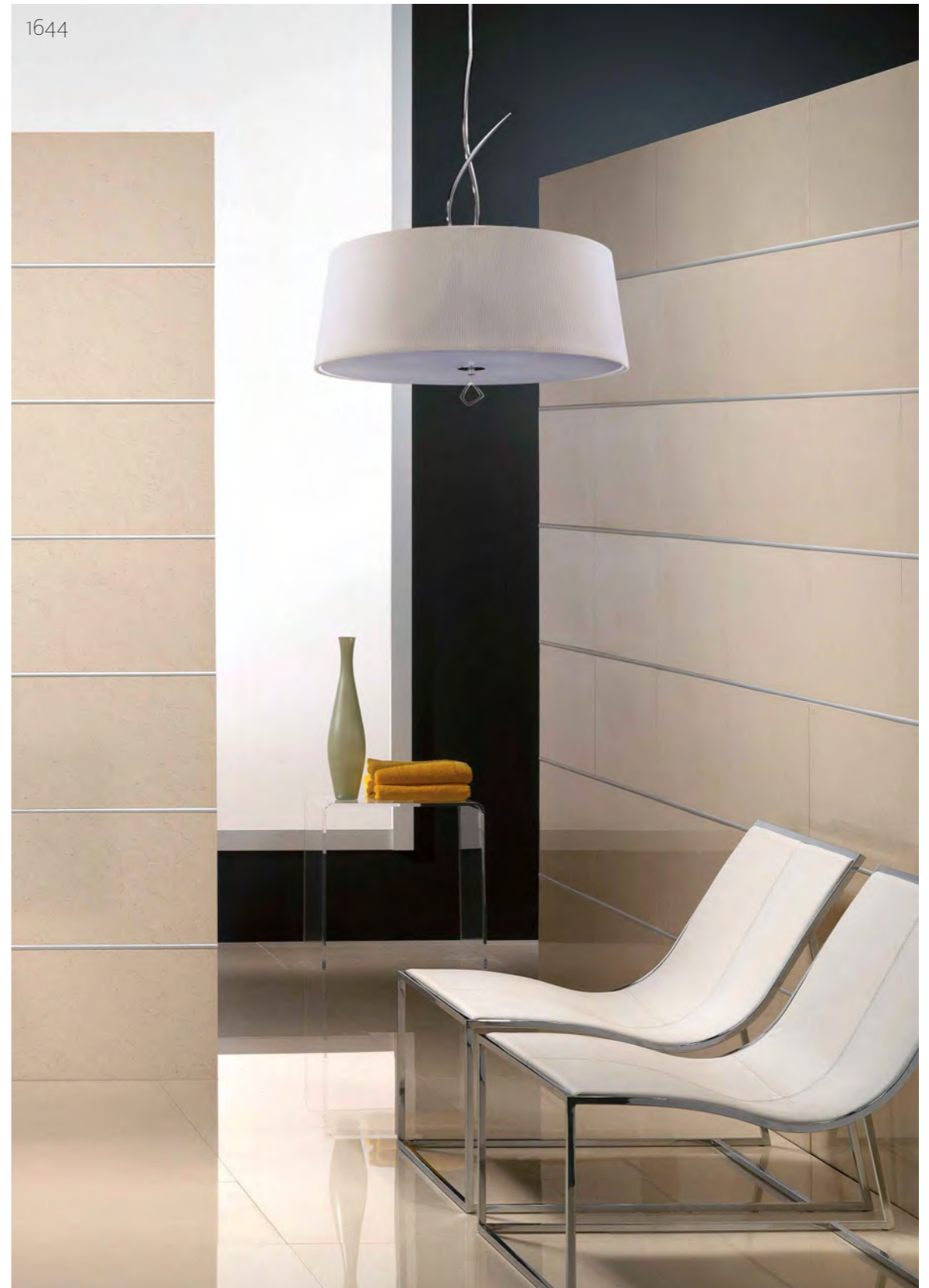

OAMI 002054213-0014 / 002054213-0016 / 002054213-0015 / 001993718-0007 / 001993718-0005 / 001993718-0006 / 001993718-0008  
ZL 201230233532.1 / ZL 201230233564.1 / ZL 201230233574.5 / ZL 201230233595.7

Lámpara - Pendant Lamp

**1642** Cromo - Chrome  
 Pantalla blanco roto - Off white shade  
 5x E14 máx.20W/no incl

**1622** Cuero - Antique brass  
 Pantalla blanco - White shade  
 5x E14 máx.20W/no incl



Lámpara - Pendant Lamp

**1640** Cromo - Chrome  
 Pantalla blanco roto - Off white shade  
 3x E14 máx.20W/no incl

**1620** Cuero - Antique brass  
 Pantalla blanco - White shade  
 3x E14 máx.20W/no incl



Lámpara - Pendant Lamp

**1641** Cromo - Chrome  
 Pantalla blanco roto - Off white shade  
 5x E14 máx.20W/no incl

**1621** Cuero - Antique brass  
 Pantalla blanco - White shade  
 5x E14 máx.20W/no incl



Lámpara - Pendant Lamp

**1654** Cromo - Chrome  
 Pantalla blanco roto - Off white shade  
 8x E14 máx.20W/no incl

**1634** Cuero - Antique brass  
 Pantalla blanco - White shade  
 8x E14 máx.20W/no incl

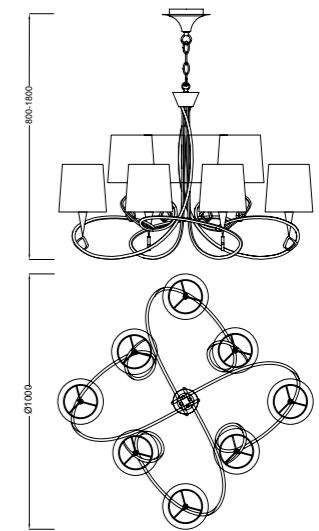
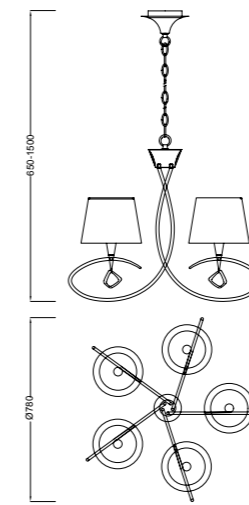
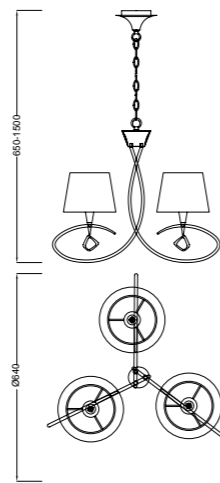
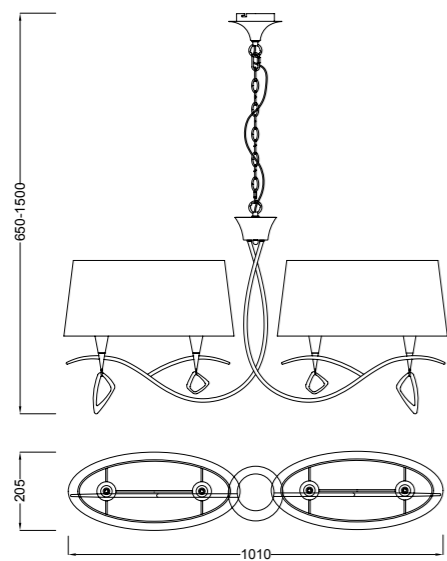



**Colgante - Pendant Lamp**

**1644** Cromo - Chrome  
 Pantalla blanco roto - Off white shade  
 4x E27 máx.20W/no incl

**1624** Cuero - Antique brass  
 Pantalla blanco - White shade  
 4x E27 máx.20W/no incl

**Semi Plafón - Semi Ceiling Lamp**

**1645** Cromo - Chrome  
 Pantalla blanco roto - Off white shade  
 4x E27 máx.20W/no incl

**1625** Cuero - Antique brass  
 Pantalla blanco - White shade  
 4x E27 máx.20W/no incl

**Plafón - Ceiling Lamp**

**1646** Cromo - Chrome  
 Pantalla blanco roto - Off white shade  
 4x E27 máx.20W/no incl

**1626** Cuero - Antique brass  
 Pantalla blanco - White shade  
 4x E27 máx.20W/no incl

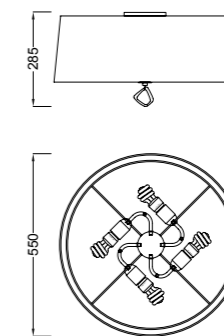
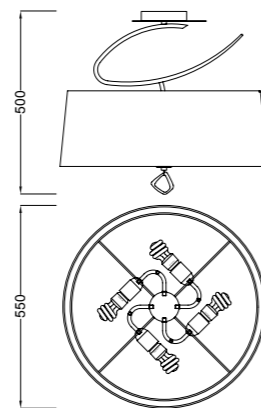
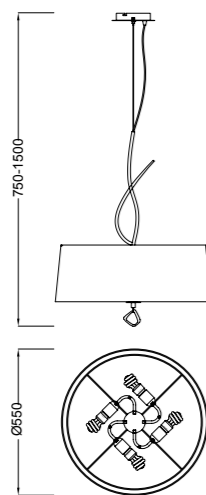

**Aplique - Wall Lamp**

**1647** Cromo - Chrome  
 Pantalla blanco roto - Off white shade  
 1x E14 máx.20W/no incl

**1627** Cuero - Antique brass  
 Pantalla blanco - White shade  
 1x E14 máx.20W/no incl

**Aplique - Wall Lamp**

**1648** Cromo - Chrome  
 Pantalla blanco roto - Off white shade  
 2x E14 máx.20W/no incl

**1628** Cuero - Antique brass  
 Pantalla blanco - White shade  
 2x E14 máx.20W/no incl

**Sobremesa - Table Lamp**

**1649** Cromo - Chrome  
 Pantalla blanco roto - Off white shade  
 1x E14 máx.20W/no incl

**1629** Cuero - Antique brass  
 Pantalla blanco - White shade  
 1x E14 máx.20W/no incl

**Sobremesa - Table Lamp**

**1651** Cromo - Chrome  
 Pantalla blanco roto - Off white shade  
 2x E14 máx.20W/no incl

**1631** Cuero - Antique brass  
 Pantalla blanco - White shade  
 2x E14 máx.20W/no incl

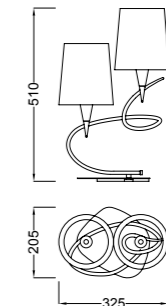
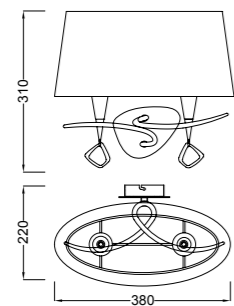



**Sobremesa - Table Lamp**

**1650** Cromo - Chrome  
 Pantalla blanco roto - Off white shade  
 1x E14 máx.20W/no incl

**1630** Cuero - Antique brass  
 Pantalla blanco - White shade  
 1x E14 máx.20W/no incl

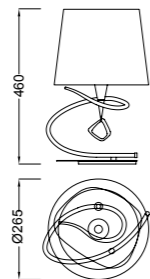

**Pie de salón - Floor Lamp**

**1652** Cromo - Chrome  
 Pantalla blanco roto - Off white shade  
 4x E27 máx.20W/no incl

**1632** Cuero - Antique brass  
 Pantalla blanco - White shade  
 4x E27 máx.20W/no incl

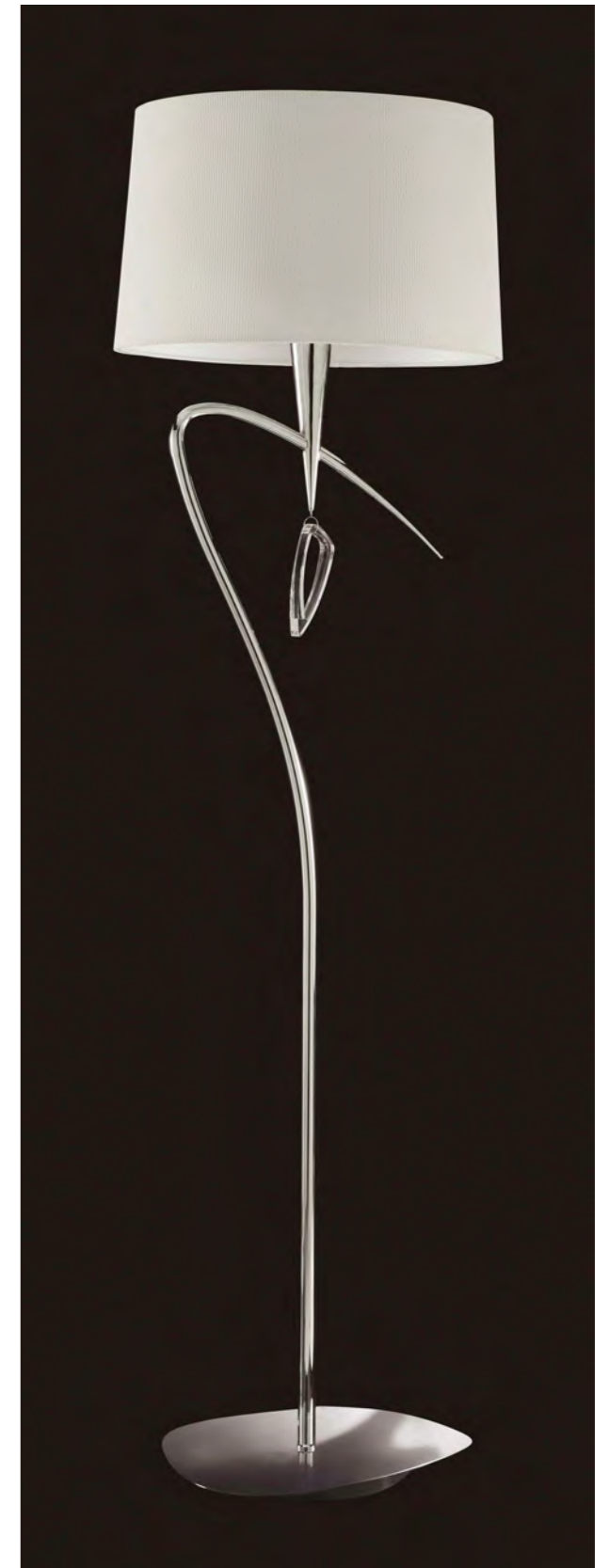
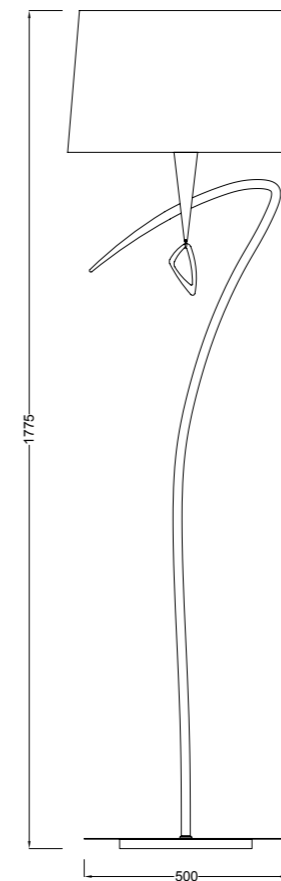

220-240V- 50/60Hz Acero / Cristal / Tela - Steel / Glass / Fabric



220-240V- 50/60Hz Acero / Cristal / Tela - Steel / Glass / Fabric

## AKIRA

Colección de iluminación sobria y sofisticada. Combina la luz ambiental que destilan sus pantallas, el cromo de sus acabados con el remate amorfo de su detalle de cristal transparente, el cual capta la luz de forma especial, distorsionándola y generando agradables brillos que la hacen distinta y espontánea en contrapunto a sus líneas rectas que la definen. Pantallas crema y negras en distintos formatos y tamaños se presentan en sus lámparas y accesorios complementarios, contando con tres apliques, dos sobremesas, pié de salón, plafón, colgante y lámparas de 3, 5 y 8 luces. Todas ellas aptas para albergar luz de bajo consumo. **Akira** pues combina la calidad de sus acabados, luz ambiental y líneas agradables, para que sus estancias tengan un toque distintivo y especial.

*Collection sober and sophisticated lighting. Combines ambient light that exude their screens, chrome finishes with your detail shot amorphous transparent glass, which captures light in a special way, distorting it and generating pleasant brightness that make it different and spontaneous in counterpoint to their lines lines that define it. Cream and black screens in different formats and sizes are presented in their lamps and complementary accessories, having three sconces two desktops, floor lamps, ceiling lamps, pendant lamps and 3, 5 and 8 lights. All suitable to house low-energy light. **Akira** it combines the quality of its finishes, ambient light and pleasant lines, so that their stays have a distinctive twist.*

José Ignacio Ballester



OAMI 001640509-0003 / 001640509-0002 / 001640509-0004 / 001640509-0001 /  
ZL 200930286484.0 / ZL 200930286485.5 / ZL 200930286486.X / ZL 200930286487.4 / ZL 200930286488.9



## Lámpara - Chandelier

**0782** Cromo - Chrome  
Pantalla negra - Black shad  
5x E14 máx.20W/no incl

**0932** Cromo - Chrome  
Pantalla crema - Cream shade  
5x E14 máx.20W/no incl

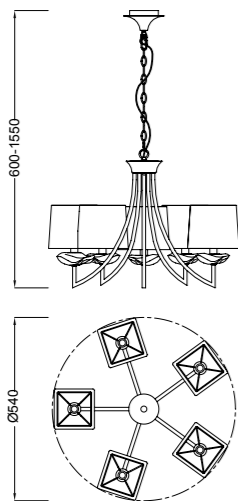

## Lámpara - Chandelier

**0780** Cromo - Chrome  
Pantalla negra - Black shad  
8x E14 máx.20W/no incl

**0930** Cromo - Chrome  
Pantalla crema - Cream shade  
8x E14 máx.20W/no incl

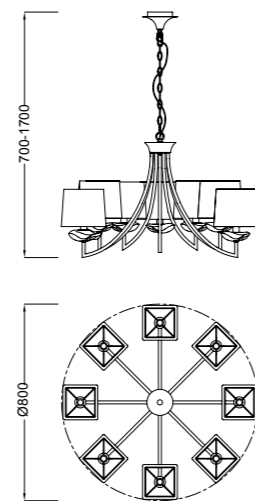

## Lámpara - Chandelier

**0792** Cromo - Chrome  
Pantalla negra - Black shad  
12x E14 máx.20W/no incl

**0942** Cromo - Chrome  
Pantalla crema - Cream shade  
12x E14 máx.20W/no incl

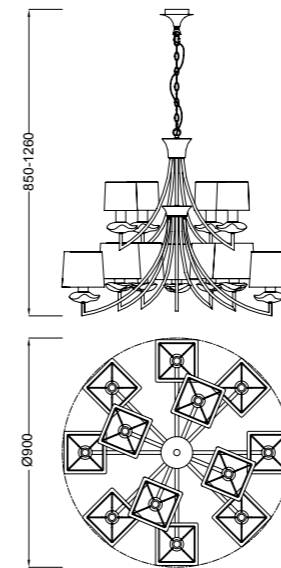

220-240V~ 50/60Hz Acero / Cristal / Tela - Steel / Glass / Fabric



220-240V~ 50/60Hz Acero / Cristal / Tela - Steel / Glass / Fabric

**Lámpara - Chandelier**

**0783** Cromo - Chrome  
Pantalla negra - Black shade  
3x E14 máx.20W/no incl

**0933** Cromo - Chrome  
Pantalla crema - Cream shade  
3x E14 máx.20W/no incl

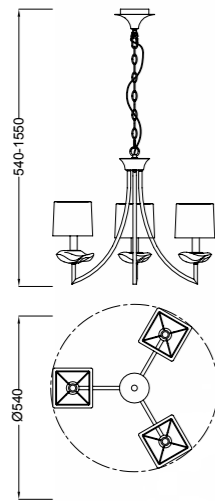



**Plafón - Ceiling Lamp**

**0785** Cromo - Chrome  
Pantalla negra - Black shad  
4x E27 máx.20W/no incl  
Clase: I

**0935** Cromo - Chrome  
Pantalla crema - Cream shade  
4x E27 máx.20W/no incl  
Clase: I

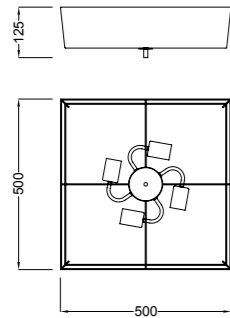
**Sobremesa - Table Lamp**

**0789** Cromo - Chrome  
Pantalla negra - Black shad  
1x E14 máx.20W/no incl  
Clase: II

**0939** Cromo - Chrome  
Pantalla crema - Cream shade  
1x E14 máx.20W/no incl  
Clase: II

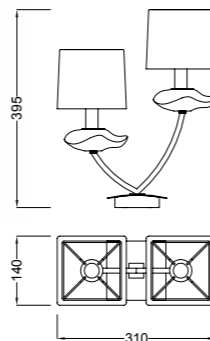
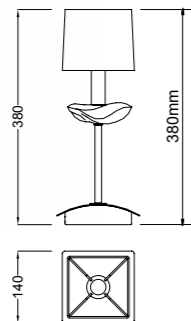
**Sobremesa - Table Lamp**

**0790** Cromo - Chrome  
Pantalla negra - Black shad  
2x E14 máx.20W/no incl  
Clase: II

**0940** Cromo - Chrome  
Pantalla crema - Cream shade  
2x E14 máx.20W/no incl  
Clase: II

**Colgante - Pendant Lamp**

**0784** Cromo - Chrome  
Pantalla negra - Black shad  
4x E27 máx.20W/no incl

**0934** Cromo - Chrome  
Pantalla crema - Cream shade  
4x E27 máx.20W/no incl

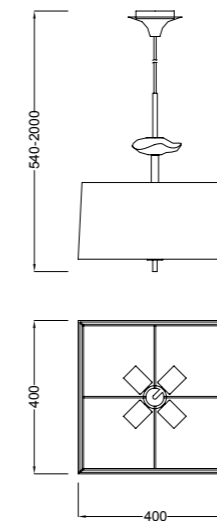
**Lámpara - Chandelier**

**0781** Cromo - Chrome  
Pantalla negra - Black shad  
6x E14 máx.20W/no incl

**0931** Cromo - Chrome  
Pantalla crema - Cream shade  
6x E14 máx.20W/no incl

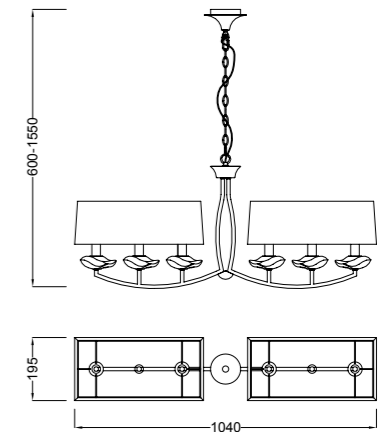

220-240V~ 50/60Hz Acero / Cristal / Tela - Steel / Glass / Fabric



220-240V~ 50/60Hz Acero / Cristal / Tela - Steel / Glass / Fabric

**Aplique - Wall Lamp**

**0786** Cromo - Chrome  
Pantalla negra - Black shad  
1x E14 máx.20W/no incl

**0936** Cromo - Chrome  
Pantalla crema - Cream shade  
1x E14 máx.20W/no incl

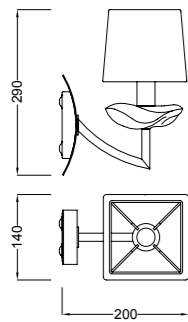

**Aplique - Wall Lamp**

**0787** Cromo - Chrome  
Pantalla negra - Black shad  
2x E14 máx.20W/no incl

**0937** Cromo - Chrome  
Pantalla crema - Cream shade  
2x E14 máx.20W/no incl

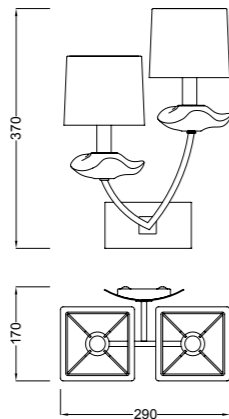

**Aplique - Wall Lamp**

**0788** Cromo - Chrome  
Pantalla negra - Black shad  
3x E14 máx.20W/no incl

**0938** Cromo - Chrome  
Pantalla crema - Cream shade  
3x E14 máx.20W/no incl

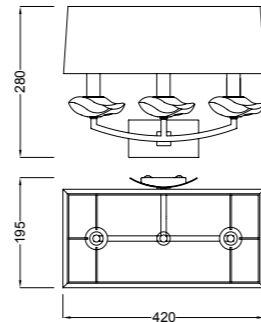

220-240V~ 50/60Hz Acero / Cristal / Tela - Steel / Glass / Fabric





R09234 R09235	Item No.	R09234	R09235
	Potencia nominal/Wattage(W)	9	
	Temperatura de color/CCT(K)	3000K	4000K
	Flujo luminoso/Luminous Flux(lm)	1000	1090
	Tension nominal/Voltage(V)	AC 220-240V 50/60Hz	
	Regulable/Dimmable	NO	
	CRI	≥80	
	Casquillo/Lamp Head	E27	
	Angulo/Beam Angle(deg)	290°	
	Material	PBT+cristal/glass	
	Dimensiones/Dimensions(mm)	Φ60*108	



R09232	Item No.	R09232
	Potencia nominal/Wattage(W)	7
	Temperatura de color/CCT(K)	2400K
	Flujo luminoso/Luminous Flux(lm)	660
	Tension nominal/Voltage(V)	AC 220-240V 50/60Hz
	Regulable/Dimmable	NO
	CRI	≥80
	Casquillo/Lamp Head	E27
	Angulo/Beam Angle(deg)	360°
	Material	Aluminio+Cristal/Aluminum+Glass
	Dimensiones/Dimensions(mm)	Φ30*300



R09206	Item No.	R09206
	Potencia nominal/Wattage(W)	8
	Temperatura de color/CCT(K)	2200K
	Flujo luminoso/Luminous Flux(lm)	640
	Tension nominal/Voltage(V)	AC 220-240V 50/60Hz
	Regulable/Dimmable	YES
	CRI	≥80
	Casquillo/Lamp Head	E27
	Angulo/Beam Angle(deg)	360°
	Material	Aluminio+Cristal/Aluminum+Glass
	Dimensiones/Dimensions(mm)	Φ64*142



R09233	Item No.	R09233
	Potencia nominal/Wattage(W)	6
	Temperatura de color/CCT(K)	2400K
	Flujo luminoso/Luminous Flux(lm)	590
	Tension nominal/Voltage(V)	AC 220-240V 50/60Hz
	Regulable/Dimmable	NO
	CRI	≥80
	Casquillo/Lamp Head	E27
	Angulo/Beam Angle(deg)	360°
	Material	Aluminio+Cristal/Aluminum+Glass
	Dimensiones/Dimensions(mm)	Φ30*185



R09228	Item No.	R09228
	Potencia nominal/Wattage(W)	6.5
	Temperatura de color/CCT(K)	2200K
	Flujo luminoso/Luminous Flux(lm)	650
	Tension nominal/Voltage(V)	AC 220-240V 50/60Hz
	Regulable/Dimmable	NO
	CRI	≥80
	Casquillo/Lamp Head	E27
	Angulo/Beam Angle(deg)	360°
	Material	Aluminio+Cristal/Aluminum+Glass
	Dimensiones/Dimensions(mm)	Φ64*138



R09205	Item No.	R09205
	Potencia nominal/Wattage(W)	8
	Temperatura de color/CCT(K)	2200K
	Flujo luminoso/Luminous Flux(lm)	640
	Tension nominal/Voltage(V)	AC 220-240V 50/60Hz
	Regulable/Dimmable	YES
	CRI	≥80
	Casquillo/Lamp Head	E27
	Angulo/Beam Angle(deg)	360°
	Material	Aluminio+Cristal/Aluminum+Glass
	Dimensiones/Dimensions(mm)	Φ125*170



R09226 R09227	Item No.	R09226	R09227
	Potencia nominal/Wattage(W)	2.5	
	Temperatura de color/CCT(K)	3000K	4000K
	Flujo luminoso/Luminous Flux(lm)	240	250
	Tension nominal/Voltage(V)	AC 220-240V 50/60Hz	
	Regulable/Dimmable	NO	
	CRI	≥80	
	Casquillo/Lamp Head	G9	
	Angulo/Beam Angle(deg)	360°	
	Material	Cristal / Glass	
	Dimensiones/Dimensions(mm)	Φ14.5*48.5	



R09230	Item No.	R09230
	Potencia nominal/Wattage(W)	6.5
	Temperatura de color/CCT(K)	2200K
	Flujo luminoso/Luminous Flux(lm)	650
	Tension nominal/Voltage(V)	AC 220-240V 50/60Hz
	Regulable/Dimmable	NO
	CRI	≥80
	Casquillo/Lamp Head	E27
	Angulo/Beam Angle(deg)	360°
	Material	Aluminio+Cristal/Aluminum+Glass
	Dimensiones/Dimensions(mm)	Φ125*176



R09115	Item No.	R09115
	Potencia nominal/Wattage(W)	4
	Temperatura de color/CCT(K)	2700K
	Flujo luminoso/Luminous Flux(lm)	400
	Tension nominal/Voltage(V)	AC 220-240V 50/60Hz
	Regulable/Dimmable	NO
	CRI	≥80
	Casquillo/Lamp Head	E14
	Angulo/Beam Angle(deg)	360°
	Material	Aluminio+Cristal/Aluminum+Glass
	Dimensiones/Dimensions(mm)	Φ35*95



R09224 R09225	Item No.	R09224	R09225
	Potencia nominal/Wattage(W)	9	
	Temperatura de color/CCT(K)	3000K	4000K
	Flujo luminoso/Luminous Flux(lm)	730	740
	Tension nominal/Voltage(V)	AC 100-250V 50/60Hz	
	Regulable/Dimmable	NO	
	CRI	≥80	
	Casquillo/Lamp Head	GX53	
	Angulo/Beam Angle(deg)	120°	
	Material	Estampacion de aluminio&PC Stamping aluminum&PC	
	Dimensiones/Dimensions(mm)	Φ75*24	



0770	370	1174	472	1914	494	3701	485	4638	443	4989	242
0771	368	1175	473	1915	496	3702	486	4639	439	4990	244
0772	370	1176	470	1916	496	3703	488	4640	438	4993	245
0773	372	1177	467	1917	497	3704	478	4730	434	4994	242
0774	374	1178	468	1918	495	3705	482	4731	435	4995	212
0775	374	1179	474	1919	493	3706	480	4732	436	4996	216
0780	510	1334	382	1920	493	3707	484	4733	437	4997	212
0781	515	1335	382	1921	492	3708	487	4734	440	4998	216
0782	510	1336	382	1922	492	3709	489	4735	441	4999	226
0783	512	1620	500	1923	494	3710	482	4736	442	5000	226
0784	515	1621	501	1924	494	3770	348	4737	442	5001	222
0785	514	1622	500	1925	496	3771	349	4738	443	5002	212
0786	516	1624	502	1926	496	3772	351	4739	439	5003	216
0787	516	1625	502	1927	497	3773	351	4740	438	5031	342
0788	516	1626	503	1928	495	3850	446	4813	310	5031	409
0789	514	1627	504	1929	495	3851	447	4860	250	5032	342
0790	514	1628	504	3530	426	3852	448	4861	254	5032	409
0792	511	1629	505	3531	426	3853	449	4862	256	5033	342
0930	510	1630	506	3532	426	3855	454	4863	256	5033	409
0931	515	1631	505	3533	428	3857	457	4864	250	5034	344
0932	510	1632	507	3535	428	3858	450	4865	250	5035	344
0933	512	1634	501	3536	428	3860	450	4866	254	5140	314
0934	515	1640	500	3537	426	3861	452	4867	256	5141	317
0935	514	1641	501	3538	428	3863	456	4870	378	5142	318
0936	516	1642	500	3540	426	3864	456	4920	339	5143	318
0937	516	1644	502	3541	426	3868	458	4921	339	5144	317
0938	516	1645	502	3542	426	3869	459	4922	339	5145	316
0939	514	1646	503	3543	428	3870	446	4923	339	5146	320
0940	514	1647	504	3545	428	3871	447	4924	338	5147	320
0942	511	1648	504	3546	428	3872	448	4925	338	5160	363
1130	464	1649	505	3547	428	3873	449	4926	332	5161	362
1131	462	1650	506	3548	428	3875	454	4927	332	5164	363
1132	466	1651	505	3615	350	3877	457	4928	334	5165	364
1133	463	1652	507	3620	354	3878	450	4929	334	5166	364
1134	472	1654	501	3621	354	3880	450	4930	334	5360	215
1135	473	1880	391	3622	354	3881	452	4931	334	5361	219
1136	470	1881	393	3623	356	3883	456	4960E	343	5362	219
1137	467	1882	393	3624	356	3884	456	4961E	343	5363	225
1138	468	1883	390	3625	356	3888	458	4962E	343	5364	229
1139	475	1885	392	3626	358	3889	459	4963E	343	5365	229
1150	464	1900	493	3627	358	4080	280	4964E	343	5366	229
1151	462	1901	492	3628	359	4081	280	4965E	343	5380	233
1152	466	1902	492	3680	479	4083	282	4966E	343	5381	233
1153	463	1903	494	3681	485	4084	283	4967E	343	5382	232
1154	472	1904	494	3682	486	4085	283	4968	344	5383	232
1155	473	1905	496	3683	488	4086	283	4980	212	5384	232
1156	470	1906	496	3684	478	4630	434	4981	216	5390	237
1157	467	1907	497	3685	482	4631	435	4982	216	5391	237
1158	468	1908	495	3686	480	4632	436	4983	222	5392	236
1159	474	1909	495	3687	484	4633	437	4984	226	5993	238
1170	464	1910	493	3688	487	4634	440	4985	226	5394	236
1171	462	1911	492	3689	489	4635	441	4986	226	5400	252
1172	466	1912	492	3690	482	4636	442	4987	212	5401	254
1173	463	1913	494	3700	479	4637	442	4988	245	5402	257



5403	257	5831	215	6006	214	6171	172	6318	418	6604	38
5430	304	5832	219	6006K	214	6172	173	6319	418	6605	39
5431	304	5860	202	6007	218	6175	402	6320	419	6607	43
5432	304	5861	202	6007K	218	6176	403	6330	416	6608	42
5433	302	5862	202	6008	228	6177	400	6331	416	6609	42
5434	306	5863	204	6008K	228	6178	404	6332	416	6612	48
5440	304	5864	204	6009	224	6179	405	6334	416	6615	47
5441	304	5870	270	6009K	224	6180	407	6335	416	6616	46
5442	304	5874	386	6010	224	6181	407	6336	421	6617	44
5443	303	5876	208	6010K	224	6182	406	6337	421	6640	68
5444	307	5895	195	6030	263	6185	190	6338	420	6641	72
5460	326	5896	196	6031	267	6186	190	6339	420	6642	74
5461	327	5897	194	6035	246	6187	190	6340	421	6643	76
5462	329	5898	199	6035K	246	6189	191	6410	405	6644	76
5463	328	5899	198	6036	246	6190	178	6411	408	6650	136
5464	328	5908	198	6036K	246	6191	178	6412	408	6651	133
5465	324	5909	199	6037	247	6192	178	6413	408	6652	132
5466	329	5910	260	6037K	247	6193	180	6414	408	6653	132
5707	215	5911	264	6100	140	6194	180	6415	290	6654	132
5725	233	5912	262	6101	141	6195	180	6416	291	6655	137
5726	233	5913	266	6102	140	6196	182	6500	184	6656	137
5727	232	5914	262	6105	146	6197	182	6501	184	6657	137
5740	292	5915	266	6106	147	6198	182	6560	90	6680	80
5741	292	5916	244	6107	148	6199	184	6561	90	6681	81
5742	292	5917	263	6108	148	6200	184	6562	98	6682	81
5746	294	5918	267	6109	149	6201	184	6563	96	6683	84
5747	294	5927	332	6110	149	6205	424	6564	88	6684	85
5760	296	5981	273	6120	158	6206	424	6565	88	6685	85
5761	296	5982	274	6121	158	6207	425	6570	122	6690	60
5762	296	5983	272	6122	154	6208	425	6571	121	6691	60
5764	298	5984	277	6123	154	6230	94	6572	126	6692	60
5766	299	5987	276	6124	159	6231	92	6573	120	6693	62
5767	299	5990	239	6125	159	6240	378	6574	127	6694	62
5768	298	5990K	239	6126	159	6241	379	6575	127	6695	62
5801	252	5991	239	6127	155	6242	379	6580	104	6696	64
5802	254	5991K	239	6128	155	6243	378	6581	108	6697	64
5805	225	5992	238	6129	155	6244	379	6582	110	6698	64
5806	215	5992K	238	6130	164	6245	379	6583	115	6705	52
5807	219	5993	238	6131	164	6260	286	6584	114	6706	54
5810	237	5993K	238	6132	165	6261	286	6585	114	6720	18
5811	237	5994	238	6133	165	6262	286	6586	103	6721	21
5812	236	5994K	238	6134	165	6263	288	6587	102	6722	26
5815	250	6000	214	6135	161	6264	288	6590	104	6723	22
5816	257	6000K	214	6136	161	6265	289	6591	109	6724	20
5817	252	6001	218	6137	162	6266	289	6592	111	6725	20
5818	252	6001K	218	6138	165	6267	287	6593	117	6726	25
5820	212	6002	218	6139	165	6268	287	6594	116	6727	25
5821	216	6002K	218	6140	165	6310	414	6595	116	6728	24
5825	215	6003	214	6141	160	6311	414	6596	103	6729	24
5826	215	6003K	214	6142	160	6312	414	6597	102	6730	28
5827	219	6004	228	6143	162	6314	414	6600	32		
5828	229	6004K	228	6144	162	6315	414	6601	32		
5829	219	6005	228	6145	162	6316	419	6602	33		
5830	229	6005K	228	6170	172	6317	419	6603	38		

mAntra

[www.mantrailuminacion.com](http://www.mantrailuminacion.com)