



**BIG WHITE<sup>®</sup>** | **21**  
SLV Lighting Catalogue



# BIG WHITE®

Whether printed or digital – with us the choice is yours.

## SLV.COM – EXPERIENCE LIGHT ONLINE

On our online platform you will find the complete SLV range with all product details, descriptions, availability, and much more. Our filter makes looking for the perfect product easy. Useful design files, 3D data, configurators and calculation tools such as FastCalc by DIAL are there to help you create your perfect lighting design. We always keep pace with the times, with news from the world of lighting, and received a Shop Usability Award in 2019. Visit [slv.com](http://slv.com)



## THE DIGITAL BIG WHITE® CATALOGUE – YOUR FLEXIBLE COMPANION



With our digital catalogue, you have a tool that will make your customer visits more efficient than ever: as well as having a digital copy of our main catalogue to hand, you can also gain quick insight into the exact SLV products you want to see through our additional services.

## SLV EXPERIENCE LIGHT APP: NOW YOU CAN EXPERIENCE REAL INSPIRATION VIRTUALLY TOO.

### Understand in advance what SLV lights can do for customers.

With our augmented reality app, SLV EXPERIENCE LIGHT, you can always find the perfect lighting – on the spot, indoors and outdoors. The app is extremely easy to use, making it an important consultation tool for electrical installers and lighting designers. Because where the customer's imagination ends, the possibilities of our app begin: give a virtual presentation of how our lights will work in their future location.



### Download the SLV EXPERIENCE LIGHT app for free.

Download our free augmented reality app from the iTunes Apple Store or Google Play Store onto your smartphone or tablet.

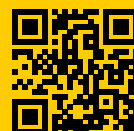

# SLV – EXPERIENCE LIGHT!

SLV is a brand that has continued to shine ever more brightly since 1979. Like the symbolic **Polar Star** in our brand logo, we now shine far beyond the borders of our German origin.

## 3500+

**MORE THAN 3,500 ITEMS IN THE BIG WHITE 2021 CATALOGUE**

Light is extremely versatile and influences every area of our life. The possibilities offered by SLV for making light a unique experience are just as versatile.

### What does Experience Light mean?

Experience Light means creating an all-round priceless experience. Through the perfect lighting solutions for a wide range of indoor and outdoor spaces, covering diverse contexts and purposes. Through excellent service, fast delivery, and easy installation. And through strong brand quality – which is available at a fair price.



Fast and reliable delivery



Great value for money

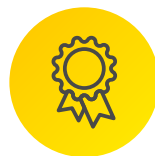

5 year guarantee\*



German engineering



98 % product availability

Our own development in Germany, long-term thinking, and rigorous quality assurance form the basis of our exceptional quality standards. You can rely on the SLV brand – even in challenging times. With a constant product availability of 98 %, we offer fast and reliable delivery to all our customers from our own logistics centre in Germany.

\*Please note the guarantee conditions available at [slv.com](http://slv.com) → Service → Downloads → Guarantee conditions.

**NEW****100+****MORE THAN 100 NEW PRODUCTS IN THE  
BIG WHITE 2021 CATALOGUE**

Here at SLV, what drives us is constant development and finding new solutions. Whether it is a matter of adapting new technologies and standards or networking and controlling devices intelligently – future-proof lighting solutions are always our priority at SLV.

**Tried and tested quality.**

The SLV test laboratories, located at SLV's German headquarters in Übach-Palenberg (North Rhine-Westphalia) and in Shanghai in Asia, contribute significantly to quality assurance and improvement.

**Distinguished design.**

Industrial designers from all over the world develop lights for the SLV brand. For designs that create special experiences and are recognised with prestigious awards.

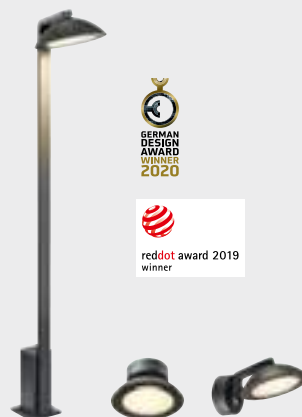
**BENDO****MALU****ESKINA****A strong partner.**

Success is always the result of close collaboration. So it's great that SLV can rely on the partnerships it has developed – both within the lighting sector and outside of it.

# GREEN LIGHT FOR SUSTAINABILITY

Our understanding of sustainability is characterised by resource-saving actions and ecological innovations. Across all core processes. With products that are better for the environment and our planet.

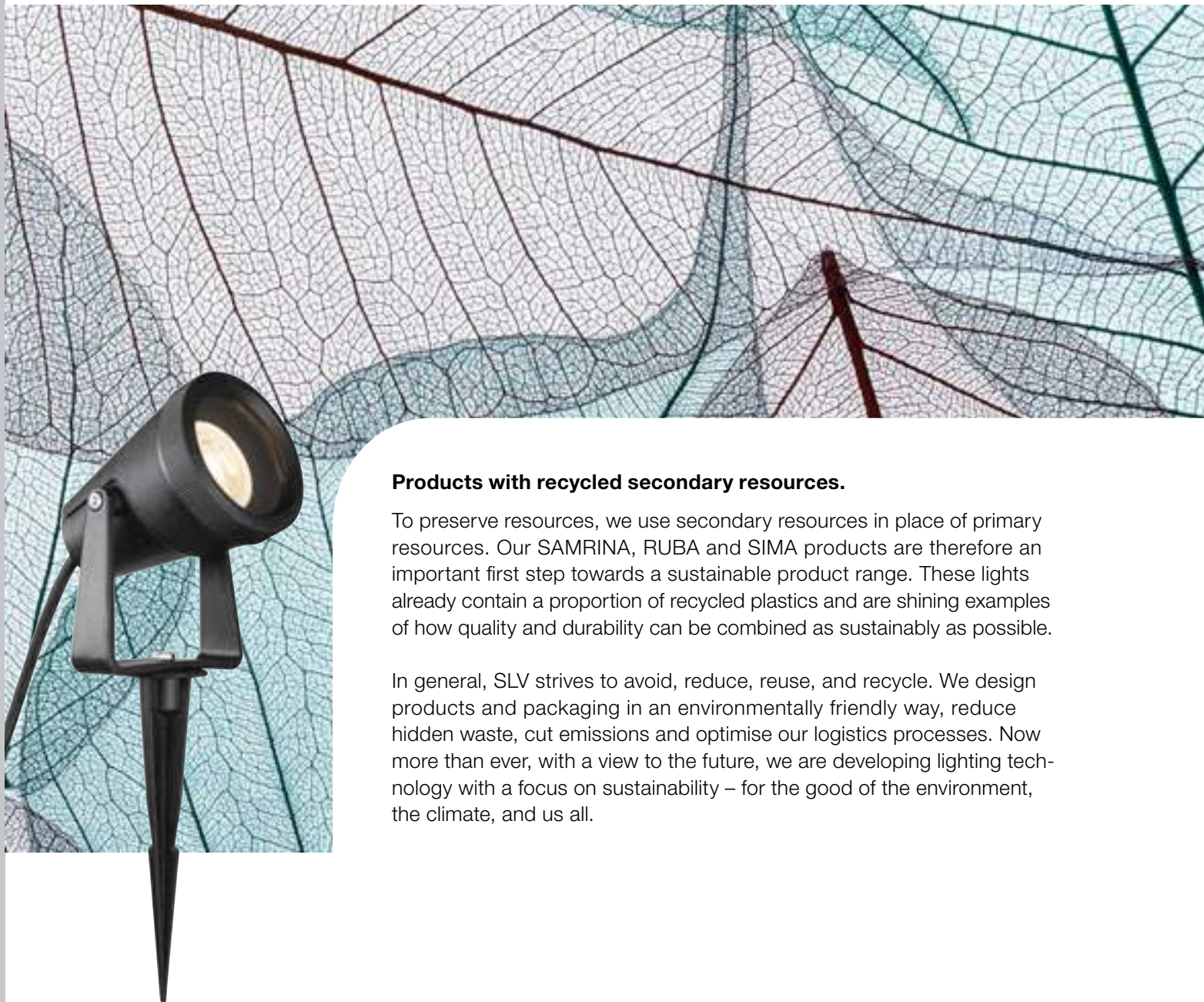

## **Products with recycled secondary resources.**

To preserve resources, we use secondary resources in place of primary resources. Our SAMRINA, RUBA and SIMA products are therefore an important first step towards a sustainable product range. These lights already contain a proportion of recycled plastics and are shining examples of how quality and durability can be combined as sustainably as possible.

In general, SLV strives to avoid, reduce, reuse, and recycle. We design products and packaging in an environmentally friendly way, reduce hidden waste, cut emissions and optimise our logistics processes. Now more than ever, with a view to the future, we are developing lighting technology with a focus on sustainability – for the good of the environment, the climate, and us all.



**Energy-efficient LED illumination.**

High efficiency, long durability, and environmentally-friendly disposal: compared to traditional lightbulbs, LEDs save up to 90 % in energy. Of course, SLV uses energy-saving technology for its lights.

**Less packaging.**

Recycled paper instead of styro-foam, reduced total volumes, and cardboard instead of plastic: when it comes to packaging, we are working specifically towards an established closed-loop economy. We also want to further minimise the emissions indirectly caused by transportation and thus our CO<sub>2</sub> footprint.



**Repair instead of disposal.**

For us, sustainability also means that more than 80 % of our lights can be repaired by trained specialists. This saves raw materials, reduces waste, and makes our customers happier.

**SAMRINA, RUBA and SIMA – shining examples of sustainable quality.**



SAMRINA  
Item No.  
1004757



RUBA  
Item No.  
1005090



SIMA  
Item No.  
1005087



SIMA  
Item No.  
1005085



**NEW** NUMINOS



**NEW** OCULUS



**NEW** NUMINOS



**NEW** OVALISK





**NUMINOS 010 - 065**

<b>N</b>	Lighting system.....	010 - 025
	Downlights.....	026 - 041
	Spotlights.....	042 - 065

**INDOOR 066 - 557**

					Table and floor lamps.....	066 - 089
					Pendant lights.....	090 - 185
					Wall lights.....	186 - 277
					Ceiling lights.....	278 - 325
					Wall and ceiling lights.....	326 - 375
					Recessed lights.....	376 - 463
					High-voltage track 3-circuit.....	464 - 505
					High-voltage track 1-circuit.....	506 - 529
					High-voltage track Easytec® II.....	530 - 539
					Low-voltage cable system and display case track.....	540 - 557

**OUTDOOR 558 - 765**

					Mobile lights and floor lights.....	558 - 613
					Spotlight.....	614 - 637
					Wall and ceiling lights.....	638 - 723
					Recessed wall lights.....	724 - 733
					Recessed ceiling lights.....	734 - 743
					Recessed floor lights.....	744 - 765

**PROFILE SOLUTIONS 766 - 787**



**LED STRIPS AND LIGHT BARS 788 - 805**



LED strips.....	788 - 803
Light bars.....	804 - 805

**CONNECTED LIGHTING 806 - 823**



DALI – Professionally connected lighting.....	806 - 813
ZIGBEE® 3.0 – The smart wireless system.....	814 - 821
SLV BLUETOOTH® CONTROL.....	822 - 823

**ACCESSORIES 824 - 843**



Accessories.....	824 - 843
------------------	-----------

**LIGHTBULB 844 - 857**



Lightbulb.....	844 - 857
----------------	-----------

**LIGHTING FAMILIES AND INDEX 858 - 898**



SLV's lighting families.....	858 - 875
Numerical.....	876 - 887
Alphabetical.....	888 - 893

You can find more lights and variants at [www.slv.com](http://www.slv.com)  
All prices are recommended retail prices (RRP) and indicated without VAT.

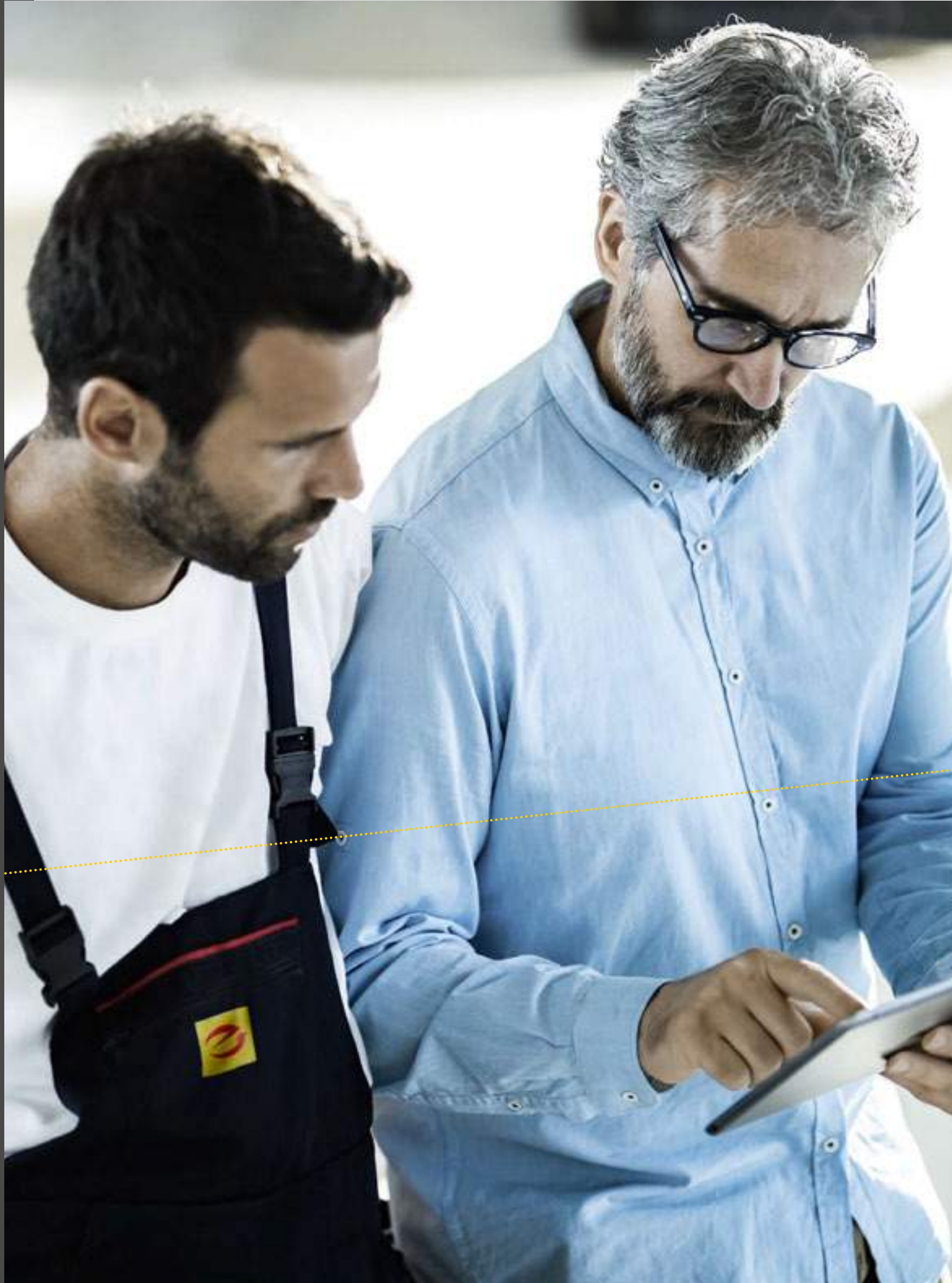

**AVAILABLE**  
FROM NOVEMBER 2020



# NUMINOS. ONE LIGHTING SYSTEM – A THOUSAND POSSIBILITIES.

THE FREELY CONFIGURABLE LIGHTING SYSTEM  
THAT CASTS A GOOD LIGHT ON EVERY SETTING.

No two projects are the same. But many projects demand a coherent lighting and design concept. NUMINOS is a perfectly coordinated lighting system that harmonises function, design and technology. For planners and doers. For every need. For maximum variety with minimum effort.

**NUMINOS.**

THE PERFECT  
LIGHTING SOLUTION  
FOR EVERY CONTEXT.

HIGH-PERFORMANCE LED MODULE  
WITH BRILLIANT COLOUR RENDERING

WIDE SELECTION OF DOWNLIGHTS  
AND SPOTS FOR A HARMONIOUS  
DESIGN CONCEPT.

# MORE FREEDOM WITH SYSTEM.

WHATEVER YOU'RE PLANNING –  
THE NUMINOS LIGHTING SYSTEM  
CREATES SPACE FOR NEW IDEAS.



The NUMINOS lighting system offers constant lighting characteristics and modern design for all uses:

- for office spaces
- shops & boutiques
- hotels & gastronomy
- museums
- at home
- and much more

From hotels and offices to commercial or private rooms. From application to technology to design in detail: it's good that the modular downlights and spotlights can be configured exactly as required by the design or space in question. And the more multifaceted your project is, the more you benefit from the NUMINOS lighting system.

Lighting that  
won't dominate.



NUMINOS  
MOVE M, DL  
Item No.  
1003553  
NUMINOS XL  
DL  
Item No.  
1003985

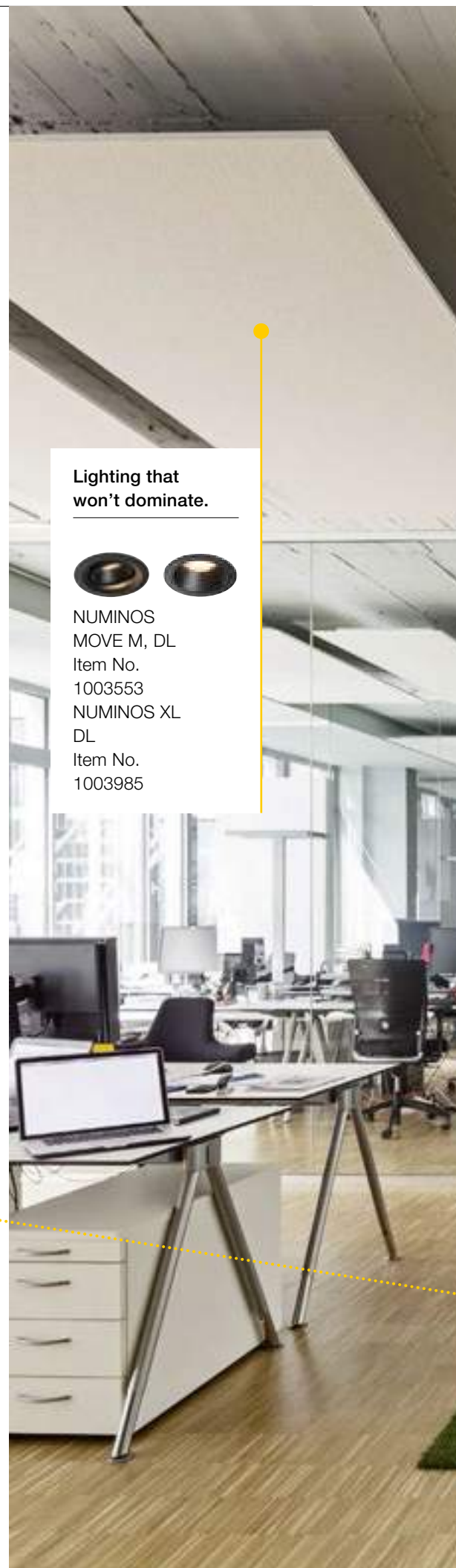

**Highlights that  
shine down.**



NUMINOS S, CL  
Item No.  
1004139

**Free for all  
dimensions.**



NUMINOS L,  
3-circuit  
Item No.  
1004554

**Perfect for  
suspending, and  
height-adjustable.**



NUMINOS L, PD  
Item No.  
1004530

## UNIQUE VARIETY, SHARED HIGHLIGHTS.

Choose between:

- Downlight or spotlight
- Various sizes and diameters
- Housing colours (black/white)
- Reflector variants
- Pivoting or rigid versions
- Performance classes

The different variants feature:

- High-performance LED module with the light colours 2700K/3000K/4000K
- Colour quality CRI>90
- Glare rating UGR min. <22



## DOWNLIGHTS

Available in seven versions (68-75mm to 176-186mm) with high-performance LED module in three light colours (2700K, 3000K, 4000K) and glare ratings (UGR 16, 19, 22)

Selectable reflectors with half beam angles of 20°, 40° or 55°.

Various effect filters (frosted / prismatic / elliptical / honeycomb) available as accessories.

Decorative ring can be selected in white, black or chrome as a visible border.

NUMINOS downlights are available as rigid or swivelling versions (4x fixed and 3x rotated and pivoted).



S M L XL

### Accessory with system:

You can easily add an optional driver (on/off, phase dimming, DALI) and suitable diffusers using the colour coding system.

You can find drivers and diffusers for the SLV NUMINOS Downlight system on pages 40-41.

# ONE LIGHTING SYSTEM INTELLIGENTLY DESIGNED IN EVERY DETAIL

Thanks to the wide selection of modules, there is a suitable solution for every need. Fixed configuration. Fast and safe to install.



## SPOTLIGHTS

Available in three housing sizes (65x155mm, 85x175mm, 100x203mm) with high-power LED module in three light colours (2700K, 3000K, 4000K)

Thanks to the built-in LED driver (phase dimming, DALI), all spotlights are suitable for direct connection to 230V mains voltage.

Selectable lenses with half beam angles of 24°, 36° or 60°.

NUMINOS spotlights are available as swivelling or fixed ceiling spots, pendant lights and as spots for 3-circuit rail systems.



### Easy to install.

Because efficiency always pays off, SLV lights are easy, quick and safe to install. Connection via mounting plate, rail system, quick-release coupling, spring clips and colour-coded drivers for downlights offers a key advantage: it saves you time and effort – and therefore costs.



# ONE LIGHTING SYSTEM. FOR EVERY EVENTUALITY.

For success under all conditions, you need team players who shine with individual strengths. Discover the applications for which the individual NUMINOS lights are particularly well suited.

## Downlights

Unobtrusive, modern and space-saving lighting that directs the gaze to particular objects or the room in general: the downlights in the NUMINOS lighting system can be used variably in commercial and private settings.



To help focus on what really matters in meeting rooms.



NUMINOS S  
DL  
Item No.  
1003798



For elegant illumination of lounge areas.



NUMINOS  
MOVE M, DL  
Item No.  
1003593





To give highlights  
an extra special  
touch.



NUMINOS M  
DL  
Item No.  
1003809



When you want your  
lighting to promote  
a sense of wellbeing.



NUMINOS  
MOVE M, DL  
Item No.  
1003620

**Individually designed illumination.**

Thanks to the large selection of reflectors on offer, the NUMINOS lighting system is suitable for accent lighting as well as for uniform illumination of work areas, corridors and offices.



For safe illumination of work surfaces.



NUMINOS S  
DL  
Item No.  
1003795

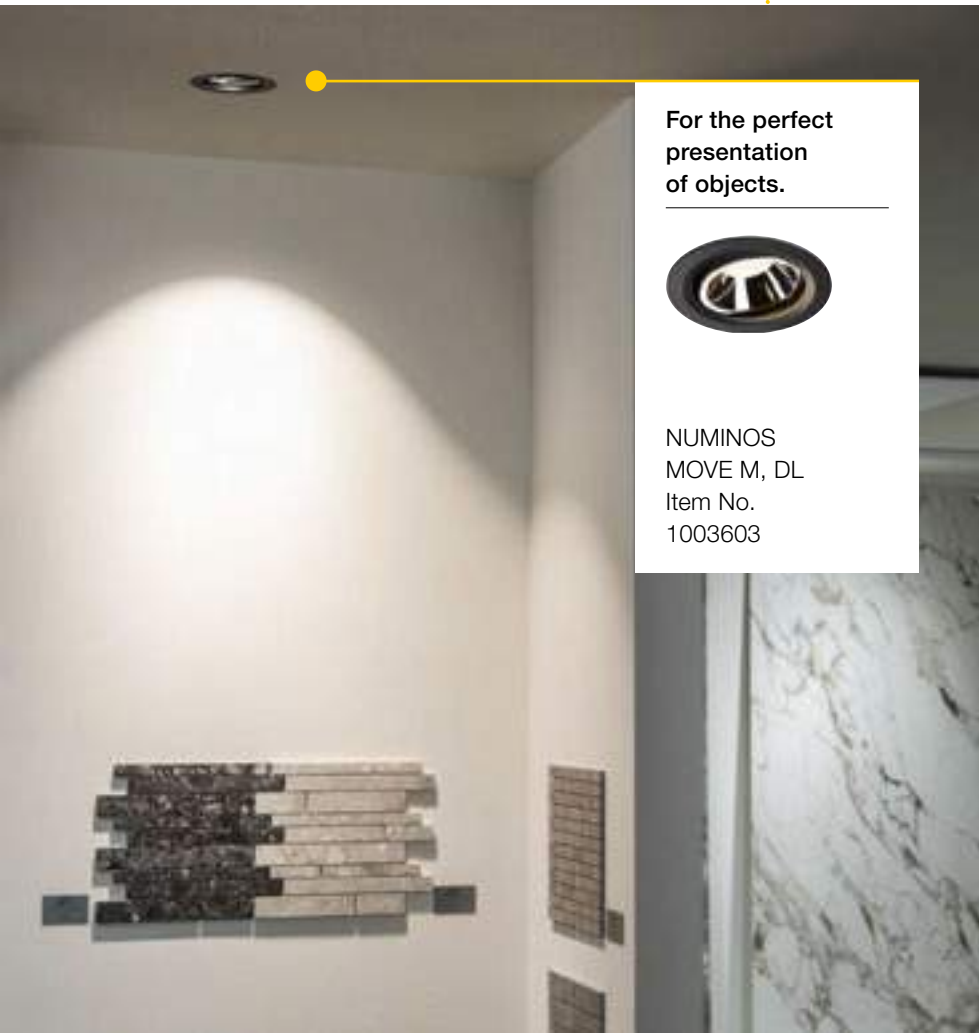

For the perfect presentation of objects.



NUMINOS  
MOVE M, DL  
Item No.  
1003603

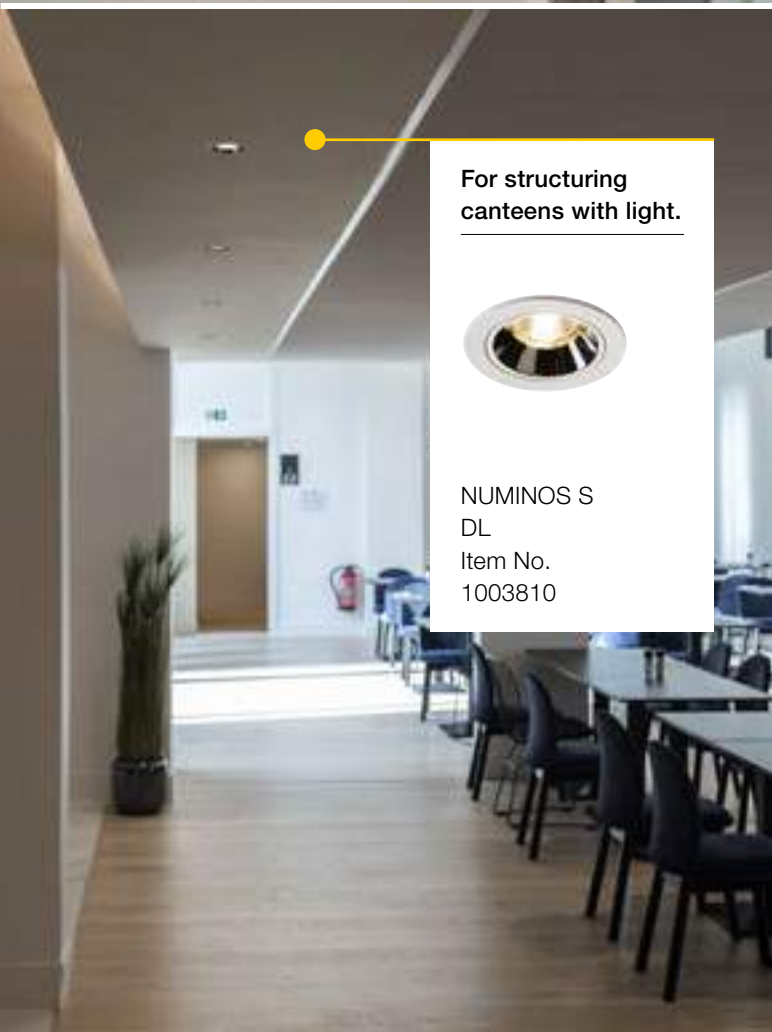

For structuring canteens with light.



NUMINOS S  
DL  
Item No.  
1003810

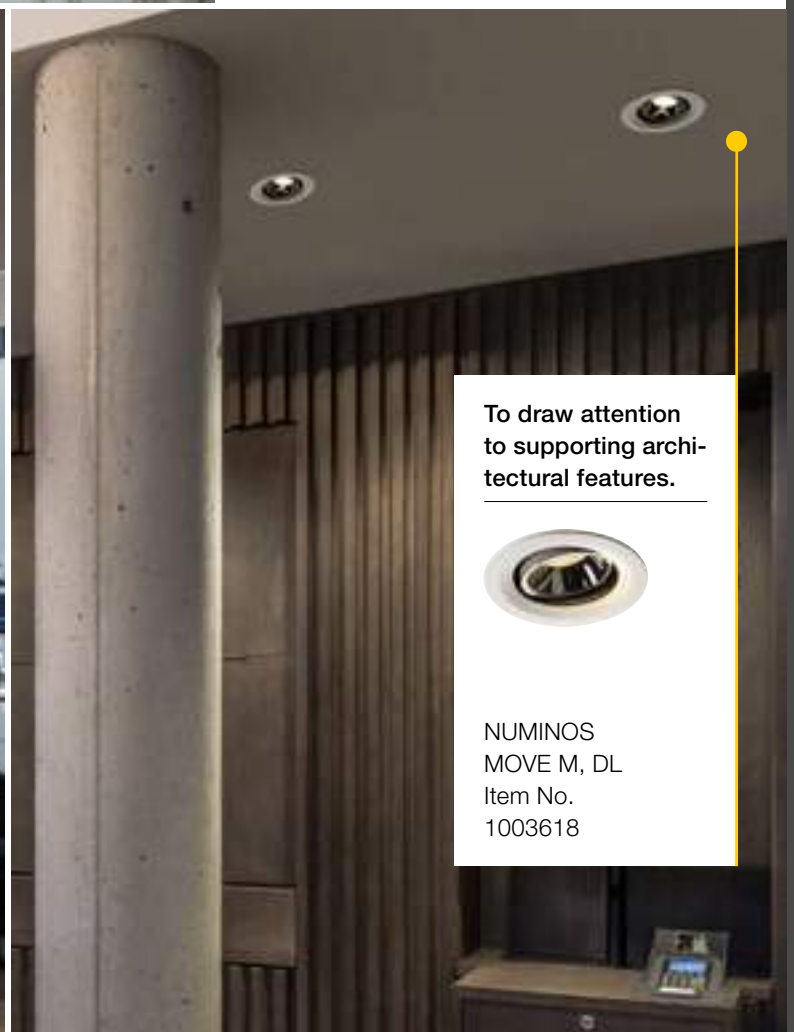

To draw attention to supporting architectural features.



NUMINOS  
MOVE M, DL  
Item No.  
1003618



For flexible illumination of spaces of all dimensions.



NUMINOS S  
3-circuit, PHASE  
Item No.  
1004083

When you want to illuminate furniture that gives structure.



NUMINOS S  
CL, PHASE  
Item No.  
1004135

**Spotlights.**

Shops and boutiques as well as restaurants, bars, museums, studios, and surgeries – every space depends on expert accent lighting. Spotlights can be used to illuminate larger spaces as well as for targeted lighting.





To create  
an appetising  
atmosphere.



NUMINOS L  
PD, DALI  
Item No.  
1004435



For a cosier home.



NUMINOS M  
PD, PHASE  
Item No.  
1004154

For effective  
perception of  
characteristics.



NUMINOS L  
3-circuit, PHASE  
Item No.  
1004287



For artistic  
accentuation of  
the highest level.



NUMINOS L  
CL, PHASE  
Item No.  
1004207

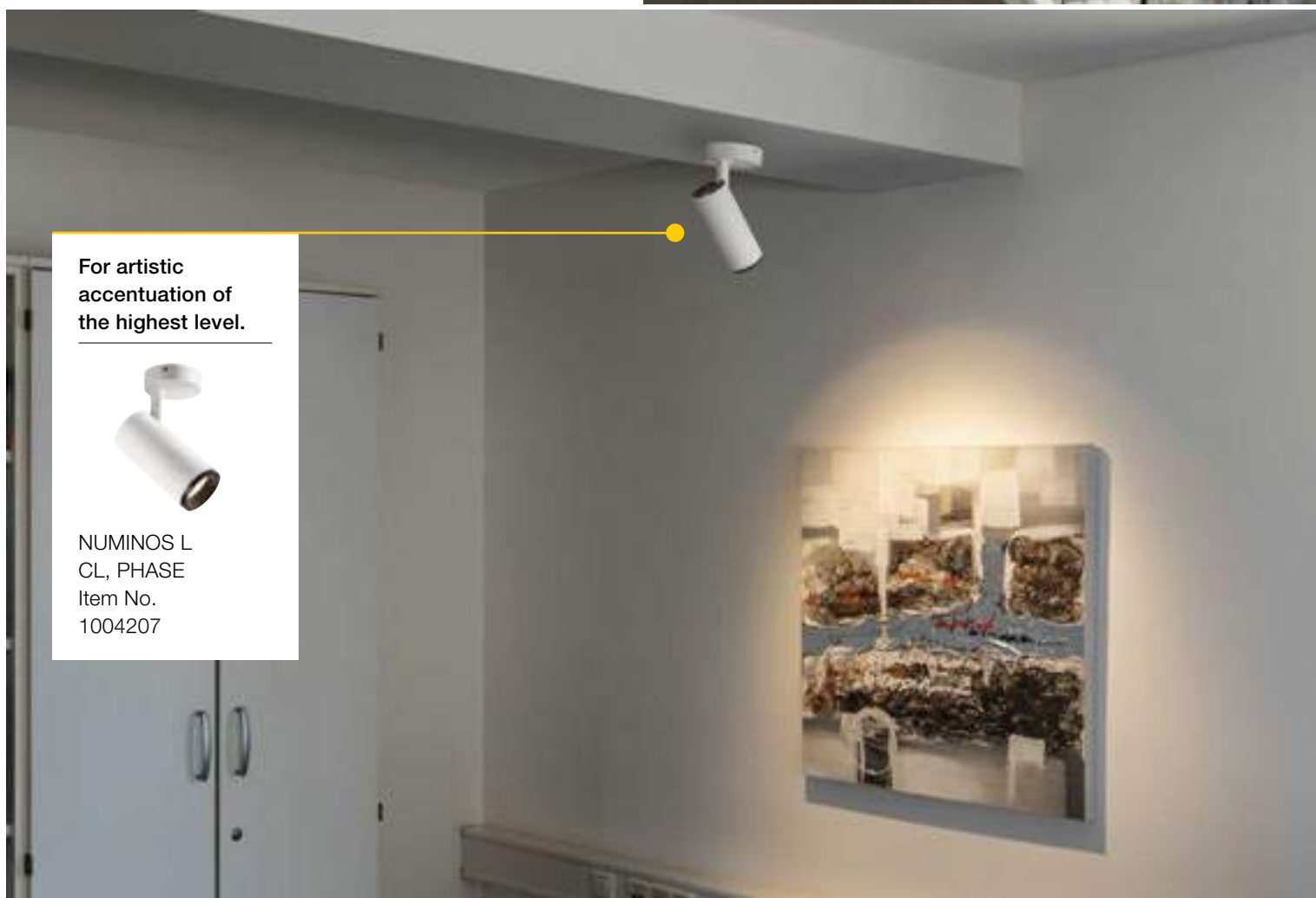

To give office spaces a striking structure.



NUMINOS M  
CL, DALI  
Item No.  
1004519

### **Flexibility in all its facets.**

Whether you're looking to create atmospheric room lighting or effective accent lighting – with the right spotlights, anything is possible. The rotating and pivoting versions in particular, as well as the rail spotlights of the NUMINOS lighting system, meet the highest demands in terms of flexibility.



# REACH YOUR GOAL SYSTEMATICALLY.

With the NUMINOS Online Configurator.

## With our configurator, it's that easy:

The first question to answer is: downlight or spotlight? You can then choose between preconfigured and additionally customisable application scenarios or free configuration.

If you are still unsure about the selection of attributes, don't worry: we offer suitable explanations for each selected configuration.

Here you can find the NUMINOS configurator:

[www.numinos.SLV.com](http://www.numinos.SLV.com)

Just three steps to reach your goal:

- 1 TECHNICAL CONFIGURATION  
↓
- 2 OPTICAL CONFIGURATION  
↓
- 3 VISUAL REPRESENTATION & COMPLETION



Reach your goal here and now – configure your lighting with the BIG WHITE® catalogue.

**Put together your dream lighting over the next pages.**

The following product overviews will help you reach your goal just as easily: scroll to your desired light type, follow the columns from left to right and make your individual selection. At the end, you will find the relevant item number for direct ordering.

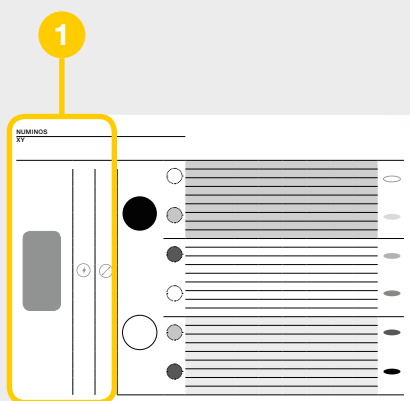

**STEP 1**

**SPOTLIGHT OR DOWNLIGHT?**

Choose the most suitable light type for your needs. The diameter (downlights) or housing size (spotlights) are coupled with the total wattage.

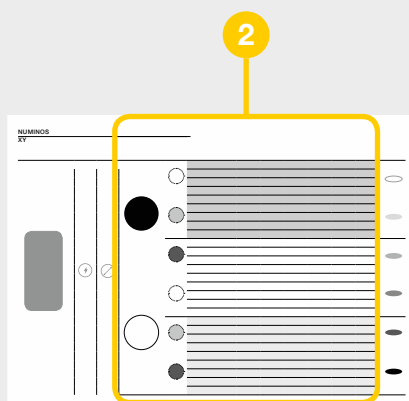

**STEP 2**

**TECHNICAL CONFIGURATION & SELECTION OF DETAILS**

Column by column, you can select optical and technical attributes such as housing colour or decorative colours, the colour temperature, half beam angle and more.

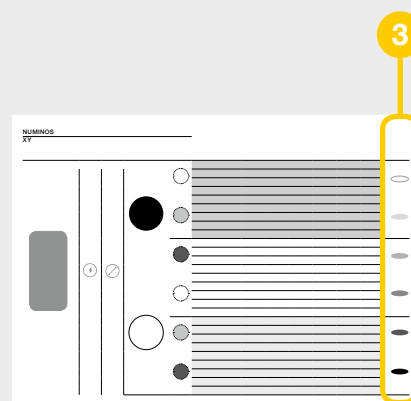

**STEP 3**

**PRODUCT**

Get a visual impression of your fully configured light and order it right away using the relevant item number.

**STILL UNSURE ABOUT SOMETHING?**

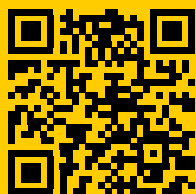

Scan me to view a video that shows how to configure NUMINOS lights.

In addition to the familiar catalog icons, you will find the following icons in this chapter:



**Glare rating**



**Colour temperature**



**Half beam angle**



**Lumen**



**Controller**

# NUMINOS S



## DL



**Product details:**

250mA

Power consumption: 8.6W

Material: aluminium/polycarbonate (PC)

Installation dimensions: Diameter: 6.8 cm D: 5.5 cm

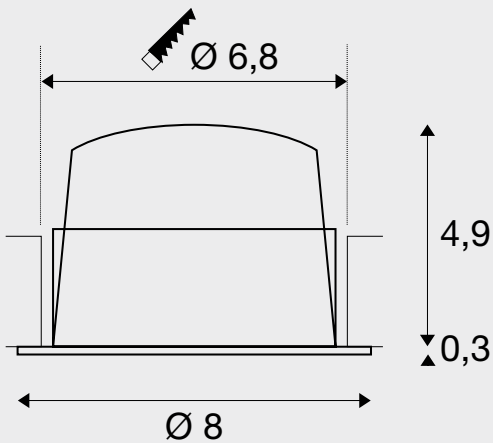

**Tip:**

Low-voltage plug  
 Driver not included  
 Leaf springs are included with the product  
 and can be replaced.

You can find suitable drivers  
 and diffusers on pages 40-41.

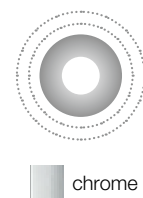
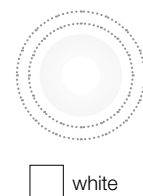
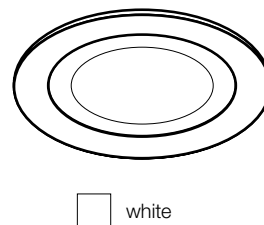
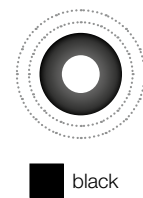
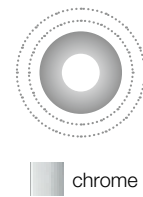
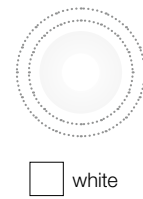
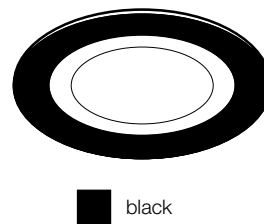



ITEM NO.

2700K	670lm	20°	18	<b>1003769</b>		
	670lm	40°	19	<b>1003772</b>		
	670lm	55°	21	<b>1003775</b>		
3000K	690lm	20°	18	<b>1003793</b>		
	690lm	40°	18	<b>1003796</b>		
	690lm	55°	20	<b>1003799</b>		
4000K	730lm	20°	18	<b>1003817</b>		
	730lm	40°	19	<b>1003820</b>		
	730lm	55°	21	<b>1003823</b>		
2700K	720lm	20°	19	<b>1003770</b>		
	720lm	40°	18	<b>1003773</b>		
	720lm	55°	20	<b>1003776</b>		
3000K	730lm	20°	18	<b>1003794</b>		
	730lm	40°	18	<b>1003797</b>		
	730lm	55°	20	<b>1003800</b>		
4000K	790lm	20°	19	<b>1003818</b>		
	790lm	40°	18	<b>1003821</b>		
	790lm	55°	20	<b>1003824</b>		
2700K	690lm	20°	16	<b>1003771</b>		
	690lm	40°	16	<b>1003774</b>		
	690lm	55°	19	<b>1003777</b>		
3000K	700lm	20°	16	<b>1003795</b>		
	700lm	40°	16	<b>1003798</b>		
	700lm	55°	18	<b>1003801</b>		
4000K	750lm	20°	16	<b>1003819</b>		
	750lm	40°	16	<b>1003822</b>		
	750lm	55°	19	<b>1003825</b>		
2700K	670lm	20°	18	<b>1003781</b>		
	670lm	40°	19	<b>1003784</b>		
	670lm	55°	21	<b>1003787</b>		
3000K	690lm	20°	18	<b>1003805</b>		
	690lm	40°	18	<b>1003808</b>		
	690lm	55°	20	<b>1003811</b>		
4000K	730lm	20°	18	<b>1003829</b>		
	730lm	40°	19	<b>1003832</b>		
	730lm	55°	21	<b>1003835</b>		
2700K	720lm	20°	19	<b>1003782</b>		
	720lm	40°	18	<b>1003785</b>		
	720lm	55°	20	<b>1003788</b>		
3000K	730lm	20°	18	<b>1003806</b>		
	730lm	40°	18	<b>1003809</b>		
	730lm	55°	20	<b>1003812</b>		
4000K	790lm	20°	19	<b>1003830</b>		
	790lm	40°	18	<b>1003833</b>		
	790lm	55°	20	<b>1003836</b>		
2700K	690lm	20°	16	<b>1003783</b>		
	690lm	40°	16	<b>1003786</b>		
	690lm	55°	19	<b>1003789</b>		
3000K	700lm	20°	16	<b>1003807</b>		
	700lm	40°	16	<b>1003810</b>		
	700lm	55°	18	<b>1003813</b>		
4000K	750lm	20°	16	<b>1003831</b>		
	750lm	40°	16	<b>1003834</b>		
	750lm	55°	19	<b>1003837</b>		

# NUMINOS M



## DL

M



**Product details:**

500mA

Power consumption: 17.5W

Material: aluminium/polycarbonate (PC)

Installation dimensions: Diameter: 9 cm D: 7.5 cm

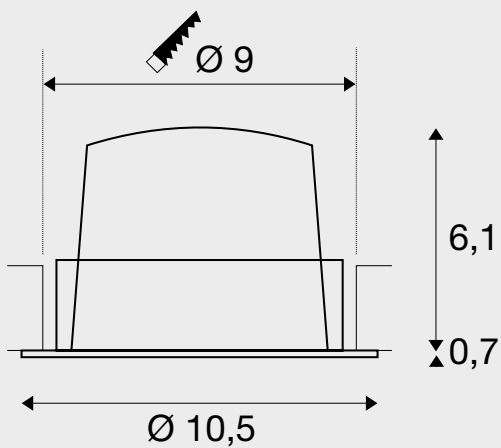
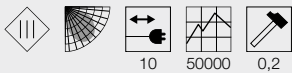

**Tip:**

Low-voltage plug  
Driver not included  
Leaf springs are included with the product and can be replaced.

You can find suitable drivers and diffusers on pages 40-41.

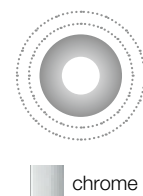
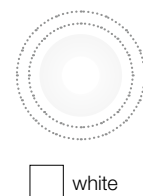
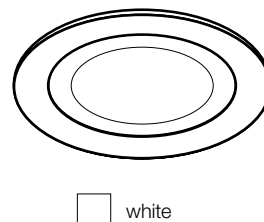
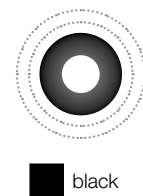
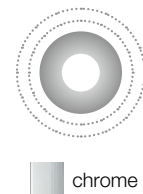
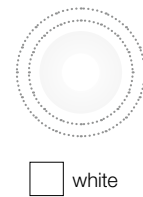
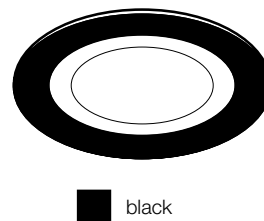



ITEM NO.

2700K	1460lm	20°	19	<b>1003841</b>	
	1460lm	40°	20	<b>1003844</b>	
	1460lm	55°	21	<b>1003847</b>	
3000K	1500lm	20°	19	<b>1003865</b>	
	1500lm	40°	20	<b>1003868</b>	
	1500lm	55°	21	<b>1003871</b>	
4000K	1600lm	20°	19	<b>1003889</b>	
	1600lm	40°	20	<b>1003892</b>	
	1600lm	55°	21	<b>1003895</b>	
2700K	1600lm	20°	20	<b>1003842</b>	
	1600lm	40°	19	<b>1003845</b>	
	1600lm	55°	20	<b>1003848</b>	
3000K	1600lm	20°	20	<b>1003866</b>	
	1600lm	40°	20	<b>1003869</b>	
	1600lm	55°	21	<b>1003872</b>	
4000K	1750lm	20°	20	<b>1003890</b>	
	1750lm	40°	20	<b>1003893</b>	
	1750lm	55°	21	<b>1003896</b>	
2700K	1550lm	20°	17	<b>1003843</b>	
	1550lm	40°	17	<b>1003846</b>	
	1550lm	55°	18	<b>1003849</b>	
3000K	1550lm	20°	17	<b>1003867</b>	
	1550lm	40°	17	<b>1003870</b>	
	1550lm	55°	19	<b>1003873</b>	
4000K	1660lm	20°	17	<b>1003891</b>	
	1660lm	40°	17	<b>1003894</b>	
	1660lm	55°	19	<b>1003897</b>	
2700K	1460lm	20°	19	<b>1003853</b>	
	1460lm	40°	20	<b>1003856</b>	
	1460lm	55°	21	<b>1003859</b>	
3000K	1500lm	20°	19	<b>1003877</b>	
	1500lm	40°	20	<b>1003880</b>	
	1500lm	55°	21	<b>1003883</b>	
4000K	1600lm	20°	19	<b>1003901</b>	
	1600lm	40°	20	<b>1003904</b>	
	1600lm	55°	21	<b>1003907</b>	
2700K	1600lm	20°	20	<b>1003854</b>	
	1600lm	40°	19	<b>1003857</b>	
	1600lm	55°	20	<b>1003860</b>	
3000K	1600lm	20°	20	<b>1003878</b>	
	1600lm	40°	20	<b>1003881</b>	
	1600lm	55°	21	<b>1003884</b>	
4000K	1750lm	20°	20	<b>1003902</b>	
	1750lm	40°	20	<b>1003905</b>	
	1750lm	55°	21	<b>1003908</b>	
2700K	1550lm	20°	17	<b>1003855</b>	
	1550lm	40°	17	<b>1003858</b>	
	1550lm	55°	18	<b>1003861</b>	
3000K	1550lm	20°	17	<b>1003879</b>	
	1550lm	40°	17	<b>1003882</b>	
	1550lm	55°	19	<b>1003885</b>	
4000K	1660lm	20°	17	<b>1003903</b>	
	1660lm	40°	17	<b>1003906</b>	
	1660lm	55°	19	<b>1003909</b>	

# NUMINOS L



## DL



**Product details:**

700mA

Power consumption: 25.4W

Material: aluminium/polycarbonate (PC)

Installation dimensions: Diameter: 11.7 cm D: 9 cm

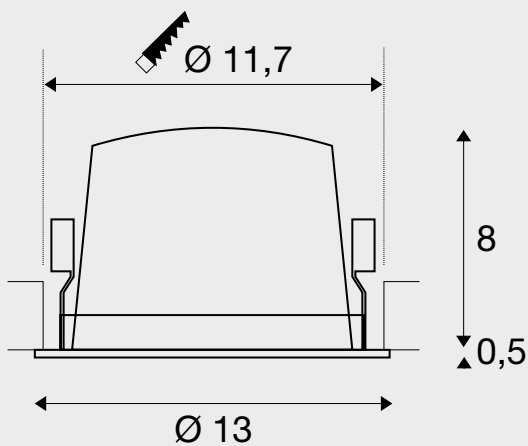
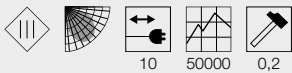

**Tip:**

Low-voltage plug  
Driver not included

You can find suitable drivers and diffusers on pages 40-41.

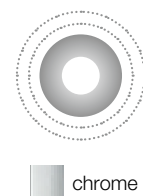
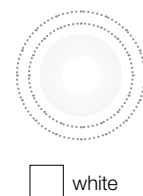
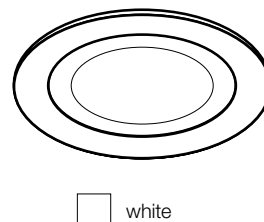
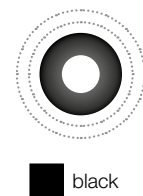
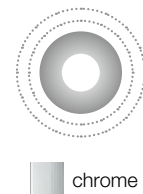
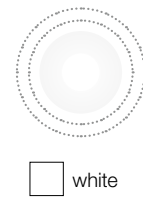
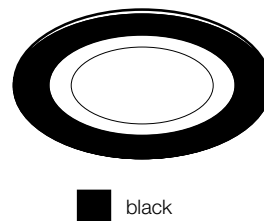



ITEM NO.

2700K	2150lm	20°	20	<b>1003913</b>		
	2150lm	40°	20	<b>1003916</b>		
	2150lm	55°	22	<b>1003919</b>		
3000K	2150lm	20°	20	<b>1003937</b>		
	2150lm	40°	21	<b>1003940</b>		
	2150lm	55°	23	<b>1003943</b>		
4000K	2350lm	20°	20	<b>1003961</b>		
	2350lm	40°	21	<b>1003964</b>		
	2350lm	55°	23	<b>1003967</b>		
2700K	2250lm	20°	18	<b>1003914</b>		
	2250lm	40°	18	<b>1003917</b>		
	2250lm	55°	20	<b>1003920</b>		
3000K	2300lm	20°	18	<b>1003938</b>		
	2300lm	40°	19	<b>1003941</b>		
	2300lm	55°	20	<b>1003944</b>		
4000K	2450lm	20°	18	<b>1003962</b>		
	2450lm	40°	19	<b>1003965</b>		
	2450lm	55°	20	<b>1003968</b>		
2700K	2150lm	20°	17	<b>1003915</b>		
	2150lm	40°	17	<b>1003918</b>		
	2150lm	55°	19	<b>1003921</b>		
3000K	2200lm	20°	17	<b>1003939</b>		
	2200lm	40°	18	<b>1003942</b>		
	2200lm	55°	19	<b>1003945</b>		
4000K	2350lm	20°	17	<b>1003963</b>		
	2350lm	40°	18	<b>1003966</b>		
	2350lm	55°	19	<b>1003969</b>		
2700K	2150lm	20°	20	<b>1003925</b>		
	2150lm	40°	20	<b>1003928</b>		
	2150lm	55°	22	<b>1003931</b>		
3000K	2150lm	20°	20	<b>1003949</b>		
	2150lm	40°	21	<b>1003952</b>		
	2150lm	55°	23	<b>1003955</b>		
4000K	2350lm	20°	20	<b>1003973</b>		
	2350lm	40°	21	<b>1003976</b>		
	2350lm	55°	23	<b>1003979</b>		
2700K	2250lm	20°	18	<b>1003926</b>		
	2250lm	40°	18	<b>1003929</b>		
	2250lm	55°	20	<b>1003932</b>		
3000K	2300lm	20°	18	<b>1003950</b>		
	2300lm	40°	19	<b>1003953</b>		
	2300lm	55°	20	<b>1003956</b>		
4000K	2450lm	20°	18	<b>1003974</b>		
	2450lm	40°	19	<b>1003977</b>		
	2450lm	55°	20	<b>1003980</b>		
2700K	2150lm	20°	17	<b>1003927</b>		
	2150lm	40°	17	<b>1003930</b>		
	2150lm	55°	19	<b>1003933</b>		
3000K	2200lm	20°	17	<b>1003951</b>		
	2200lm	40°	18	<b>1003954</b>		
	2200lm	55°	19	<b>1003957</b>		
4000K	2350lm	20°	17	<b>1003975</b>		
	2350lm	40°	18	<b>1003978</b>		
	2350lm	55°	19	<b>1003981</b>		

# NUMINOS XL



## DL

**XL**



**Product details:**

1050mA  
 Power consumption: 37.4W  
 Material: aluminium/polycarbonate (PC)  
 Installation dimensions: Diameter: 14.5 cm D: 11.5 cm

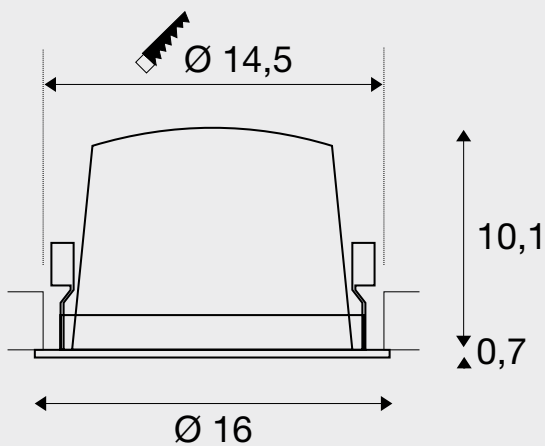

**Tip:**

Low-voltage plug  
 Driver not included

You can find suitable drivers and diffusers on pages 40-41.



black

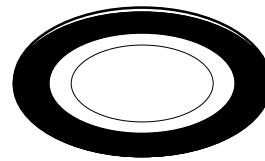

black



white

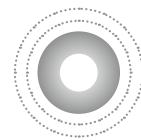

chrome



black

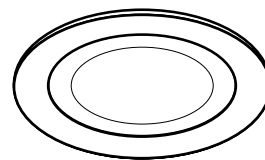

white



white



chrome





ITEM NO.

2700K	3300lm	20°	21	<b>1003985</b>		
	3300lm	40°	21	<b>1003988</b>		
	3300lm	55°	22	<b>1003991</b>		
3000K	3300lm	20°	21	<b>1004009</b>		
	3300lm	40°	21	<b>1004012</b>		
	3300lm	55°	22	<b>1004015</b>		
4000K	3600lm	20°	21	<b>1004033</b>		
	3600lm	40°	21	<b>1004036</b>		
	3600lm	55°	23	<b>1004039</b>		
2700K	3500lm	20°	18	<b>1003986</b>		
	3500lm	40°	18	<b>1003989</b>		
	3500lm	55°	19	<b>1003992</b>		
3000K	3550lm	20°	18	<b>1004010</b>		
	3550lm	40°	18	<b>1004013</b>		
	3550lm	55°	19	<b>1004016</b>		
4000K	3800lm	20°	18	<b>1004034</b>		
	3800lm	40°	18	<b>1004037</b>		
	3800lm	55°	19	<b>1004040</b>		
2700K	3400lm	20°	17	<b>1003987</b>		
	3400lm	40°	18	<b>1003990</b>		
	3400lm	55°	19	<b>1003993</b>		
3000K	3500lm	20°	17	<b>1004011</b>		
	3500lm	40°	18	<b>1004014</b>		
	3500lm	55°	19	<b>1004017</b>		
4000K	3750lm	20°	18	<b>1004035</b>		
	3750lm	40°	18	<b>1004038</b>		
	3750lm	55°	19	<b>1004041</b>		
2700K	3300lm	20°	21	<b>1003997</b>		
	3300lm	40°	21	<b>1004000</b>		
	3300lm	55°	22	<b>1004003</b>		
3000K	3300lm	20°	21	<b>1004021</b>		
	3300lm	40°	21	<b>1004024</b>		
	3300lm	55°	22	<b>1004027</b>		
4000K	3600lm	20°	21	<b>1004045</b>		
	3600lm	40°	21	<b>1004048</b>		
	3600lm	55°	23	<b>1004051</b>		
2700K	3500lm	20°	18	<b>1003998</b>		
	3500lm	40°	18	<b>1004001</b>		
	3500lm	55°	19	<b>1004004</b>		
3000K	3550lm	20°	18	<b>1004022</b>		
	3550lm	40°	18	<b>1004025</b>		
	3550lm	55°	19	<b>1004028</b>		
4000K	3800lm	20°	18	<b>1004046</b>		
	3800lm	40°	18	<b>1004049</b>		
	3800lm	55°	19	<b>1004052</b>		
2700K	3400lm	20°	17	<b>1003999</b>		
	3400lm	40°	18	<b>1004002</b>		
	3400lm	55°	19	<b>1004005</b>		
3000K	3500lm	20°	17	<b>1004023</b>		
	3500lm	40°	18	<b>1004026</b>		
	3500lm	55°	19	<b>1004029</b>		
4000K	3750lm	20°	18	<b>1004047</b>		
	3750lm	40°	18	<b>1004050</b>		
	3750lm	55°	19	<b>1004053</b>		

# NUMINOS MOVE M



## DL

M



**Product details:**

500mA

Power consumption: 17.5W

Material: aluminium/polycarbonate (PC)

Installation dimensions: Diameter: 12 cm D: 10 cm

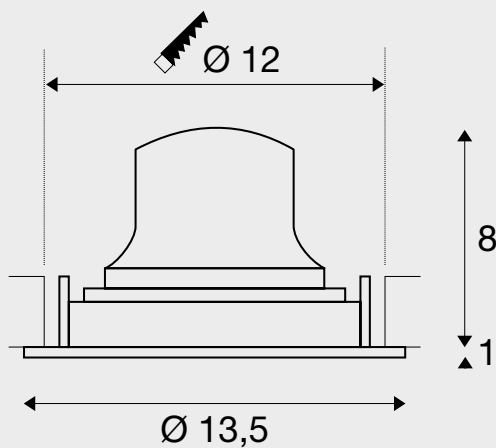

**Tip:**

Low-voltage plug  
Driver not included

You can find suitable drivers and diffusers on pages 40-41.

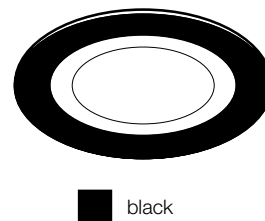

black

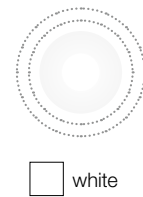

white

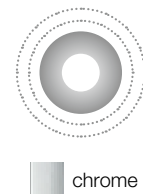

chrome



black

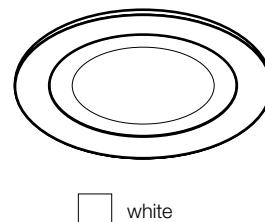

white

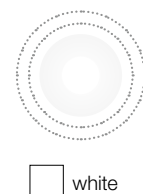

white



chrome



ITEM NO.

2700K	1460lm	20°	19	<b>1003553</b>				
	1460lm	40°	20	<b>1003556</b>				
	1460lm	55°	21	<b>1003559</b>				
3000K	1500lm	20°	19	<b>1003577</b>				
	1500lm	40°	20	<b>1003580</b>				
	1500lm	55°	21	<b>1003583</b>				
4000K	1600lm	20°	19	<b>1003601</b>				
	1600lm	40°	20	<b>1003604</b>				
	1600lm	55°	21	<b>1003607</b>				
2700K	1600lm	20°	20	<b>1003554</b>				
	1600lm	40°	19	<b>1003557</b>				
	1600lm	55°	20	<b>1003560</b>				
3000K	1600lm	20°	20	<b>1003578</b>				
	1600lm	40°	20	<b>1003581</b>				
	1600lm	55°	21	<b>1003584</b>				
4000K	1750lm	20°	20	<b>1003602</b>				
	1750lm	40°	20	<b>1003605</b>				
	1750lm	55°	21	<b>1003608</b>				
2700K	1550lm	20°	17	<b>1003555</b>				
	1550lm	40°	17	<b>1003558</b>				
	1550lm	55°	18	<b>1003561</b>				
3000K	1550lm	20°	17	<b>1003579</b>				
	1550lm	40°	17	<b>1003582</b>				
	1550lm	55°	19	<b>1003585</b>				
4000K	1660lm	20°	17	<b>1003603</b>				
	1660lm	40°	17	<b>1003606</b>				
	1660lm	55°	19	<b>1003609</b>				
2700K	1460lm	20°	19	<b>1003565</b>				
	1460lm	40°	20	<b>1003568</b>				
	1460lm	55°	21	<b>1003571</b>				
3000K	1500lm	20°	19	<b>1003589</b>				
	1500lm	40°	20	<b>1003592</b>				
	1500lm	55°	21	<b>1003595</b>				
4000K	1600lm	20°	19	<b>1003613</b>				
	1600lm	40°	20	<b>1003616</b>				
	1600lm	55°	21	<b>1003619</b>				
2700K	1600lm	20°	20	<b>1003566</b>				
	1600lm	40°	19	<b>1003569</b>				
	1600lm	55°	20	<b>1003572</b>				
3000K	1600lm	20°	20	<b>1003590</b>				
	1600lm	40°	20	<b>1003593</b>				
	1600lm	55°	21	<b>1003596</b>				
4000K	1750lm	20°	20	<b>1003614</b>				
	1750lm	40°	20	<b>1003617</b>				
	1750lm	55°	21	<b>1003620</b>				
2700K	1550lm	20°	17	<b>1003567</b>				
	1550lm	40°	17	<b>1003570</b>				
	1550lm	55°	18	<b>1003573</b>				
3000K	1550lm	20°	17	<b>1003591</b>				
	1550lm	40°	17	<b>1003594</b>				
	1550lm	55°	19	<b>1003597</b>				
4000K	1660lm	20°	17	<b>1003615</b>				
	1660lm	40°	17	<b>1003618</b>				
	1660lm	55°	19	<b>1003621</b>				

# NUMINOS MOVE L



## DL



**Product details:**

750mA

Power consumption: 25.4W

Material: aluminium/polycarbonate (PC)

Installation dimensions: Diameter: 14.5 cm D: 10.5 cm

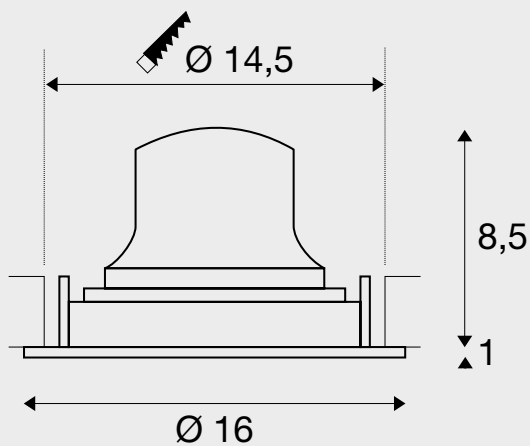

**Tip:**

Low-voltage plug  
Driver not included

You can find suitable drivers and diffusers on pages 40-41.

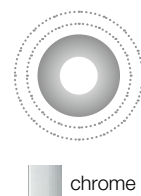
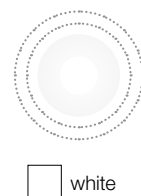
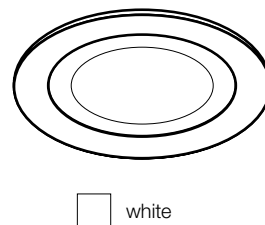
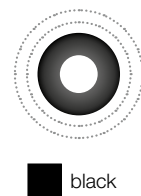
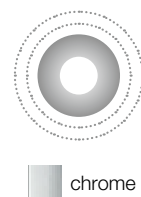
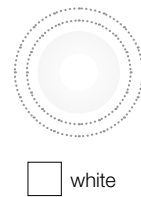
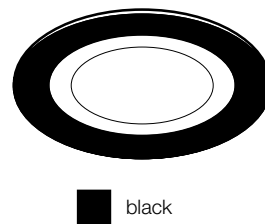



ITEM NO.

2700K	2150lm	20°	20	<b>1003625</b>	
	2150lm	40°	20	<b>1003628</b>	
	2150lm	55°	22	<b>1003631</b>	
3000K	2150lm	20°	20	<b>1003649</b>	
	2150lm	40°	21	<b>1003652</b>	
	2150lm	55°	23	<b>1003655</b>	
4000K	2350lm	20°	20	<b>1003673</b>	
	2350lm	40°	21	<b>1003676</b>	
	2350lm	55°	23	<b>1003679</b>	
2700K	2250lm	20°	18	<b>1003626</b>	
	2250lm	40°	18	<b>1003629</b>	
	2250lm	55°	20	<b>1003632</b>	
3000K	2300lm	20°	18	<b>1003650</b>	
	2300lm	40°	19	<b>1003653</b>	
	2300lm	55°	20	<b>1003656</b>	
4000K	2450lm	20°	18	<b>1003674</b>	
	2450lm	40°	19	<b>1003677</b>	
	2450lm	55°	20	<b>1003680</b>	
2700K	2150lm	20°	17	<b>1003627</b>	
	2150lm	40°	17	<b>1003630</b>	
	2150lm	55°	19	<b>1003633</b>	
3000K	2200lm	20°	17	<b>1003651</b>	
	2200lm	40°	18	<b>1003654</b>	
	2200lm	55°	19	<b>1003657</b>	
4000K	2350lm	20°	17	<b>1003675</b>	
	2350lm	40°	18	<b>1003678</b>	
	2350lm	55°	19	<b>1003681</b>	
2700K	2150lm	20°	20	<b>1003637</b>	
	2150lm	40°	20	<b>1003640</b>	
	2150lm	55°	22	<b>1003643</b>	
3000K	2150lm	20°	20	<b>1003661</b>	
	2150lm	40°	21	<b>1003664</b>	
	2150lm	55°	23	<b>1003667</b>	
4000K	2350lm	20°	20	<b>1003685</b>	
	2350lm	40°	21	<b>1003688</b>	
	2350lm	55°	23	<b>1003691</b>	
2700K	2250lm	20°	18	<b>1003638</b>	
	2250lm	40°	18	<b>1003641</b>	
	2250lm	55°	20	<b>1003644</b>	
3000K	2300lm	20°	18	<b>1003662</b>	
	2300lm	40°	19	<b>1003665</b>	
	2300lm	55°	20	<b>1003668</b>	
4000K	2450lm	20°	18	<b>1003686</b>	
	2450lm	40°	19	<b>1003689</b>	
	2450lm	55°	20	<b>1003692</b>	
2700K	2150lm	20°	17	<b>1003639</b>	
	2150lm	40°	17	<b>1003642</b>	
	2150lm	55°	19	<b>1003645</b>	
3000K	2200lm	20°	17	<b>1003663</b>	
	2200lm	40°	18	<b>1003666</b>	
	2200lm	55°	19	<b>1003669</b>	
4000K	2350lm	20°	17	<b>1003687</b>	
	2350lm	40°	18	<b>1003690</b>	
	2350lm	55°	19	<b>1003693</b>	

# NUMINOS MOVE XL



## DL

**XL**



**Product details:**

1050mA  
 Power consumption: 37.4W  
 Material: aluminium/polycarbonate (PC)  
 Installation dimensions: Diameter: 17.5 cm D: 13 cm

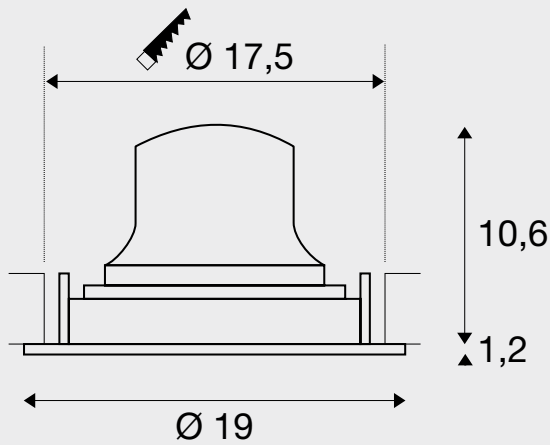
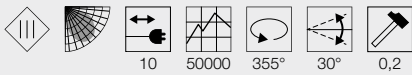

**Tip:**

Low-voltage plug  
 Driver not included

You can find suitable drivers and diffusers on pages 40-41.

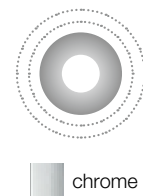
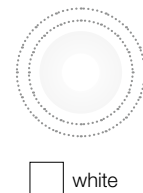
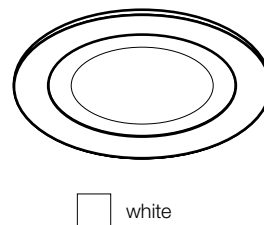
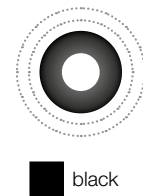
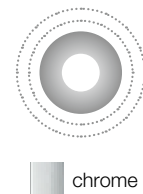
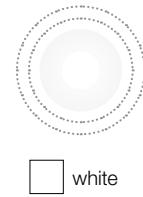
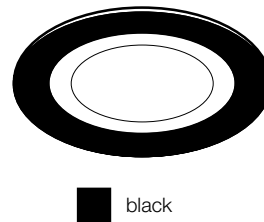



ITEM NO.

2700K	3300lm	20°	21	<b>1003697</b>	
	3300lm	40°	21	<b>1003700</b>	
	3300lm	55°	22	<b>1003703</b>	
3000K	3300lm	20°	21	<b>1003721</b>	
	3300lm	40°	21	<b>1003724</b>	
	3300lm	55°	22	<b>1003727</b>	
4000K	3600lm	20°	21	<b>1003745</b>	
	3600lm	40°	21	<b>1003748</b>	
	3600lm	55°	23	<b>1003751</b>	
2700K	3500lm	20°	18	<b>1003698</b>	
	3500lm	40°	18	<b>1003701</b>	
	3500lm	55°	19	<b>1003704</b>	
3000K	3550lm	20°	18	<b>1003722</b>	
	3550lm	40°	18	<b>1003725</b>	
	3550lm	55°	19	<b>1003728</b>	
4000K	3800lm	20°	18	<b>1003746</b>	
	3800lm	40°	18	<b>1003749</b>	
	3800lm	55°	19	<b>1003752</b>	
2700K	3400lm	20°	17	<b>1003699</b>	
	3400lm	40°	18	<b>1003702</b>	
	3400lm	55°	19	<b>1003705</b>	
3000K	3500lm	20°	17	<b>1003723</b>	
	3500lm	40°	18	<b>1003726</b>	
	3500lm	55°	19	<b>1003729</b>	
4000K	3750lm	20°	18	<b>1003747</b>	
	3750lm	40°	18	<b>1003750</b>	
	3750lm	55°	19	<b>1003753</b>	
2700K	3300lm	20°	21	<b>1003709</b>	
	3300lm	40°	21	<b>1003712</b>	
	3300lm	55°	22	<b>1003715</b>	
3000K	3300lm	20°	21	<b>1003733</b>	
	3300lm	40°	21	<b>1003736</b>	
	3300lm	55°	22	<b>1003739</b>	
4000K	3600lm	20°	21	<b>1003757</b>	
	3600lm	40°	21	<b>1003760</b>	
	3600lm	55°	23	<b>1003763</b>	
2700K	3500lm	20°	18	<b>1003710</b>	
	3500lm	40°	18	<b>1003713</b>	
	3500lm	55°	19	<b>1003716</b>	
3000K	3550lm	20°	18	<b>1003734</b>	
	3550lm	40°	18	<b>1003737</b>	
	3550lm	55°	19	<b>1003740</b>	
4000K	3800lm	20°	18	<b>1003758</b>	
	3800lm	40°	18	<b>1003761</b>	
	3800lm	55°	19	<b>1003764</b>	
2700K	3400lm	20°	17	<b>1003711</b>	
	3400lm	40°	18	<b>1003714</b>	
	3400lm	55°	19	<b>1003717</b>	
3000K	3500lm	20°	17	<b>1003735</b>	
	3500lm	40°	18	<b>1003738</b>	
	3500lm	55°	19	<b>1003741</b>	
4000K	3750lm	20°	18	<b>1003759</b>	
	3750lm	40°	18	<b>1003762</b>	
	3750lm	55°	19	<b>1003765</b>	













# Accessory









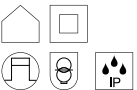
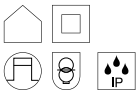
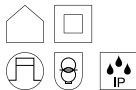
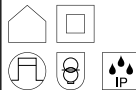
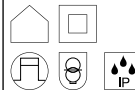
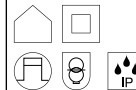

## Perfect driver assignment

	LED driver 250mA, 10W	LED driver 250mA, 10W, PHASE	LED driver 250mA, 20W, DALI	LED driver 700mA, 30W	LED driver 500mA, 30W, PHASE	LED driver 500mA, 40W, DALI
	<b>S</b>	<b>S</b>	<b>S</b>	<b>M</b>	<b>M</b>	<b>M</b>
	250mA	250mA	250/350/500/700mA	500/600/700mA	500mA	250/350/500/700mA
<b>Material</b>	Polycarbonate (PC)	Polycarbonate (PC)	Polycarbonate (PC)	Polycarbonate (PC)	Polycarbonate (PC)	Polycarbonate (PC)
<b>Colour</b>	white	white	white	white	white	white
<b>Voltage prim.</b>	220-240V ~50/60Hz	220-240V ~50/60Hz	220-240V ~50/60Hz	220-240V ~50/60Hz	220-240V ~50/60Hz	220-240V ~50/60Hz
<b>Voltage sec.</b>	26-40V	30-42V	6-60V	30-42V	42-60V	6-58V
<b>Output current</b>	250mA	250mA	250/350/500/700mA	500/600/700mA	500mA	250/350/500/700mA
<b>Number of outputs sec.</b>	1	1	1	1	1	1
<b>Output from</b>	6.5W	7.5W	1.5W	15W	21W	1.5W
<b>Output up to</b>	10W	10W	15W	29.5W	30W	40.6W
<b>Environmental temp. min.</b>	-20°C	-20°C	-20°C	-20°C	-25°C	-25°C
<b>Environmental temp. max.</b>	45°C	50°C	50°C	50°C	50°C	50°C
<b>Temperature protection</b>	110°C	110°C	110°C	110°C	110°C	110°C
<b>IP protection rating</b>	IP 20	IP 20	IP 20	IP 20	IP 20	IP 20
<b>Dimmable</b>	-	PHASE C	DALI	-	PHASE C	DALI
<b>Length</b>	6.5 cm	8.5 cm	15 cm	14.7 cm	13.8 cm	12.3 cm
<b>Width</b>	3.9 cm	3.9 cm	5.2 cm	4.3 cm	4.4 cm	7.9 cm
<b>Height</b>	2 cm	2.2 cm	2.8 cm	3 cm	3 cm	2.4 cm
<b>Weight</b>	0.05 kg	0.05 kg	0.142 kg	0.105 kg	0.13 kg	1.21 kg
<b>Item No.</b>	<b>1004058</b>	<b>1004055</b>	<b>1004067</b>	<b>1004064</b>	<b>1004054</b>	<b>1004069</b>

	<b>S</b>				<b>M</b>			
<b>Voltage prim.</b>	SL153 elliptical	SL154 prismatic	SL155 frosted	SL305 honeycomb	SL153A elliptical	SL154A prismatic	SL155A frosted	SL306 honeycomb
<b>Item No.</b>	<b>1004786</b>	<b>1004787</b>	<b>1004788</b>	<b>1004789</b>	<b>1004790</b>	<b>1004791</b>	<b>1004792</b>	<b>1004793</b>



						
	LED driver 1050mA, 40W	LED driver 700mA, 30W, PHASE	LED driver 700mA, 40W, DALI	LED driver 1050mA, 40W	LED driver 1000mA, 40W, PHASE	LED driver 1050mA, 50W, DALI
						
						
	500/600/700mA	700mA	700mA	800/900/1050mA	1000mA	1050mA
Material	Polycarbonate (PC)	Polycarbonate (PC)	Polycarbonate (PC)	Polycarbonate (PC)	Polycarbonate (PC)	Polycarbonate (PC)
Colour	white	white	white	white	white	white
Voltage prim.	220-240V ~50/60Hz	220-240V ~50/60Hz	220-240V ~50/60Hz	220-240V ~50/60Hz	220-240V ~50/60Hz	220-240V ~50/60Hz
Voltage sec.	30-42V	30-42V	6-58V	30-42V	28-40V	6-58V
Output current	500/600/700mA	700mA	250/350/500/700mA	800/900/1050mA	1000mA	700/800/900/1050/ 1200/1300/1400mA
Number of outputs sec.	1	1	1	1	1	1
Output from	15W	21W	1.5W	24W	28W	4.2W
Output up to	29.5W	29.4W	40.6W	44W	40W	50W
Environmental temp. min.	-20°C	-20°C	-25°C	-20°C	-20°C	-25°C
Environmental temp. max.	50°C	50°C	50°C	50°C	50°C	50°C
Temperature protection	110°C	110°C	110°C	110°C	110°C	110°C
IP protection rating	IP 20	IP 20	IP 20	IP 20	IP 20	IP 20
Dimmable	-	PHASE C	DALI	-	PHASE C	DALI
Length	14.7 cm	11.5W	12.3 cm	9.7 cm	15.3 cm	12.3 cm
Width	4.3 cm	4.4 cm	7.9 cm	4.3 cm	6.7 cm	7.9 cm
Height	3 cm	3 cm	2.4 cm	3 cm	3 cm	2.4 cm
Weight	0.105 kg	0.072 kg	1.21 kg	0.072 kg	0.2 kg	0.215 kg
Item No.	1004062	1004065	1004070	1004059	1004066	1004071

								
								
Voltage prim.	SL153B elliptical	SL154B prismatic	SL155B frosted	SL307 honeycomb	SL153C elliptical	SL154C prismatic	SL155C frosted	SL308 honeycomb
Item No.	1004794	1004795	1004796	1004797	1004798	1004799	1004800	1004801

# NUMINOS S



## 3-circuit

**Product details:**

220-240V ~50/60Hz | 250mA

Total wattage: 10.42W

Material: aluminium/plastic

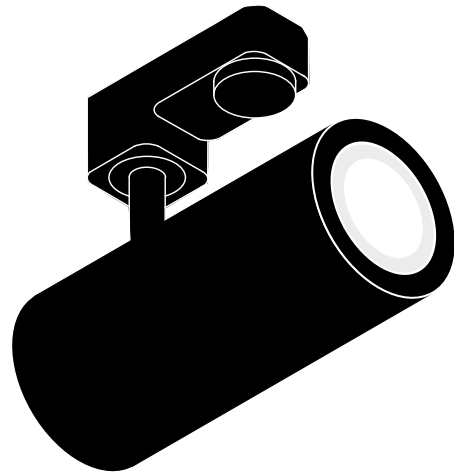
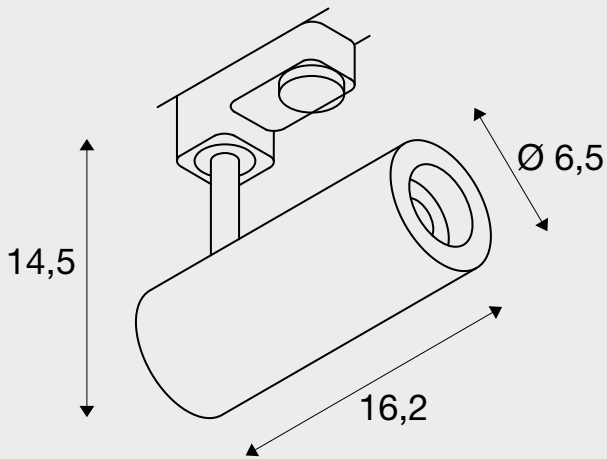

■ black

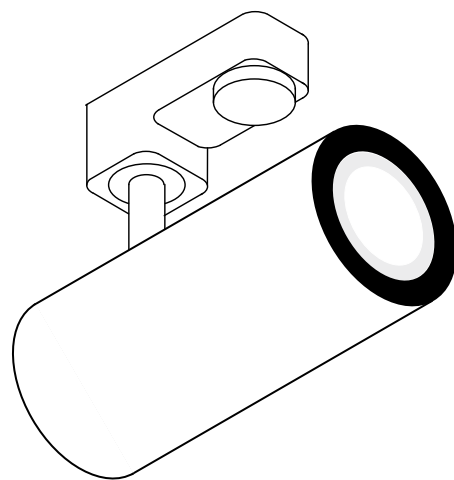

□ white



ITEM NO.

	2700K	985lm	24°	<b>1004074</b>	
		985lm	36°	<b>1004075</b>	
		980lm	60°	<b>1004076</b>	
	3000K	1020lm	24°	<b>1004082</b>	
		1020lm	36°	<b>1004083</b>	
		1020lm	60°	<b>1004084</b>	
	4000K	110lm	24°	<b>1004090</b>	
		110lm	36°	<b>1004091</b>	
		110lm	60°	<b>1004092</b>	

	2700K	985lm	24°	<b>1004362</b>	
		985lm	36°	<b>1004363</b>	
		980lm	60°	<b>1004364</b>	
	3000K	1020lm	24°	<b>1004370</b>	
		1020lm	36°	<b>1004371</b>	
		1020lm	60°	<b>1004372</b>	
	4000K	110lm	24°	<b>1004378</b>	
		110lm	36°	<b>1004379</b>	
		110lm	60°	<b>1004380</b>	

	2700K	980lm	24°	<b>1004078</b>	
		985lm	36°	<b>1004079</b>	
		980lm	60°	<b>1004080</b>	
	3000K	1020lm	24°	<b>1004086</b>	
		1020lm	36°	<b>1004087</b>	
		1020lm	60°	<b>1004088</b>	
	4000K	1090lm	24°	<b>1004094</b>	
		110lm	36°	<b>1004095</b>	
		1090lm	60°	<b>1004096</b>	

	2700K	985lm	24°	<b>1004366</b>	
		985lm	36°	<b>1004367</b>	
		980lm	60°	<b>1004368</b>	
	3000K	1020lm	24°	<b>1004374</b>	
		1020lm	36°	<b>1004375</b>	
		1020lm	60°	<b>1004376</b>	
	4000K	110lm	24°	<b>1004382</b>	
		110lm	36°	<b>1004383</b>	
		110lm	60°	<b>1004384</b>	

# NUMINOS M



## 3-circuit

**Product details:**

220-240V ~50/60Hz | 500mA

Total wattage: 20.1W

Material: aluminium/plastic

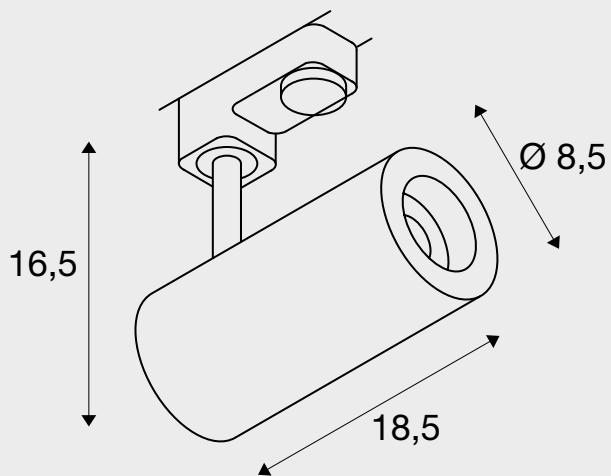

■ black

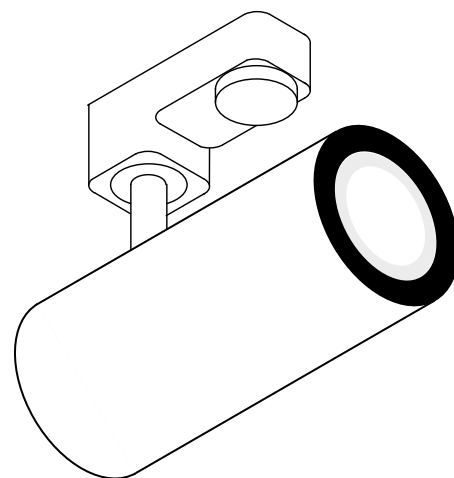

□ white



ITEM NO.

	2700K	1925lm	24°	<b>1004170</b>	
		1935lm	36°	<b>1004171</b>	
		1885lm	60°	<b>1004172</b>	
	3000K	1955lm	24°	<b>1004178</b>	
		1970lm	36°	<b>1004179</b>	
		1880lm	60°	<b>1004180</b>	
	4000K	2125lm	24°	<b>1004186</b>	
		21020lm	36°	<b>1004187</b>	
	2060lm	60°	<b>1004188</b>		

	2700K	1925lm	24°	<b>1004458</b>	
		1935lm	36°	<b>1004459</b>	
		1885lm	60°	<b>1004460</b>	
	3000K	1930lm	24°	<b>1004466</b>	
		1970lm	36°	<b>1004467</b>	
		1880lm	60°	<b>1004468</b>	
	4000K	2125lm	24°	<b>1004474</b>	
		21020lm	36°	<b>1004475</b>	
	2060lm	60°	<b>1004476</b>		

	2700K	1925lm	24°	<b>1004174</b>	
		1935lm	36°	<b>1004175</b>	
		1870lm	60°	<b>1004176</b>	
	3000K	1955lm	24°	<b>1004182</b>	
		1970lm	36°	<b>1004183</b>	
		1870lm	60°	<b>1004184</b>	
	4000K	2125lm	24°	<b>1004190</b>	
		21020lm	36°	<b>1004191</b>	
	2060lm	60°	<b>1004192</b>		

	2700K	1925lm	24°	<b>1004462</b>	
		1935lm	36°	<b>1004463</b>	
		1885lm	60°	<b>1004464</b>	
	3000K	1955lm	24°	<b>1004470</b>	
		1970lm	36°	<b>1004471</b>	
		1880lm	60°	<b>1004472</b>	
	4000K	2125lm	24°	<b>1004478</b>	
		21020lm	36°	<b>1004479</b>	
	2060lm	60°	<b>1004480</b>		

# NUMINOS L



## 3-circuit

**Product details:**

220-240V ~50/60Hz | 700mA

System output: 28W

Material: aluminium/plastic

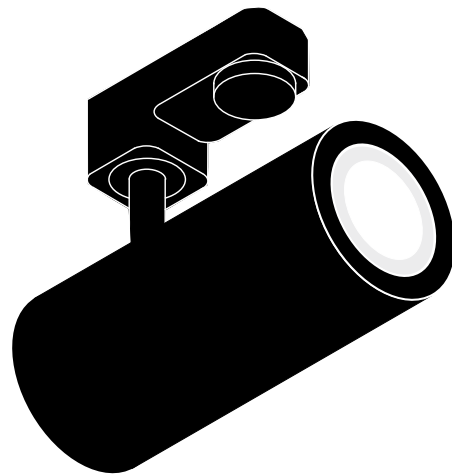
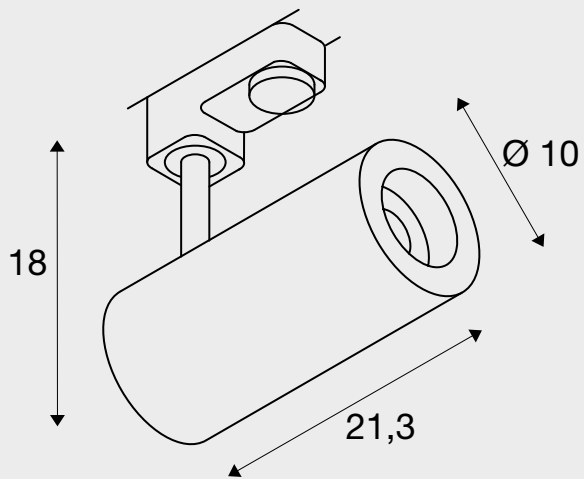

■ black

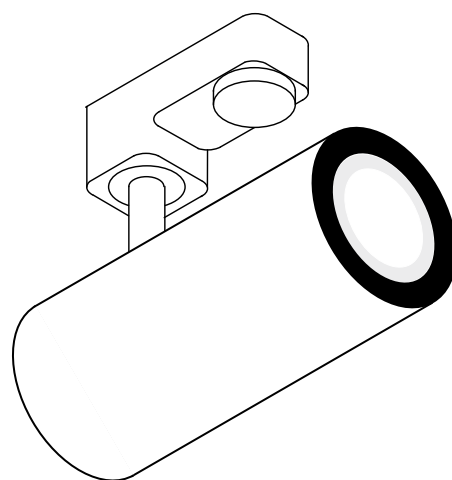

□ white



ITEM NO.

	2700K	2440lm	24°	<b>1004266</b>	
		2400lm	36°	<b>1004267</b>	
		2475lm	60°	<b>1004268</b>	
	3000K	2430lm	24°	<b>1004274</b>	
		2340lm	36°	<b>1004275</b>	
		2400lm	60°	<b>1004276</b>	
	4000K	2675lm	24°	<b>1004282</b>	
		2620lm	36°	<b>1004283</b>	
		2715lm	60°	<b>1004284</b>	

	2700K	2430lm	24°	<b>1004554</b>	
		2400lm	36°	<b>1004555</b>	
		2475lm	60°	<b>1004556</b>	
	3000K	2430lm	24°	<b>1004562</b>	
		2340lm	36°	<b>1004563</b>	
		2400lm	60°	<b>1004564</b>	
	4000K	2675lm	24°	<b>1004570</b>	
		2620lm	36°	<b>1004571</b>	
		2715lm	60°	<b>1004572</b>	

	2700K	2430lm	24°	<b>1004270</b>	
		2400lm	36°	<b>1004271</b>	
		2475lm	60°	<b>1004272</b>	
	3000K	2430lm	24°	<b>1004278</b>	
		2340lm	36°	<b>1004279</b>	
		2400lm	60°	<b>1004280</b>	
	4000K	2675lm	24°	<b>1004286</b>	
		2620lm	36°	<b>1004287</b>	
		2715lm	60°	<b>1004288</b>	

	2700K	2440lm	24°	<b>1004558</b>	
		2400lm	36°	<b>1004559</b>	
		2475lm	60°	<b>1004560</b>	
	3000K	2430lm	24°	<b>1004566</b>	
		2340lm	36°	<b>1004567</b>	
		2400lm	60°	<b>1004568</b>	
	4000K	2675lm	24°	<b>1004574</b>	
		2620lm	36°	<b>1004575</b>	
		2715lm	60°	<b>1004576</b>	

# NUMINOS S



## CW

**Product details:**

220-240V ~50/60Hz | 250mA

Total wattage: 10.42W

Material: aluminium/plastic

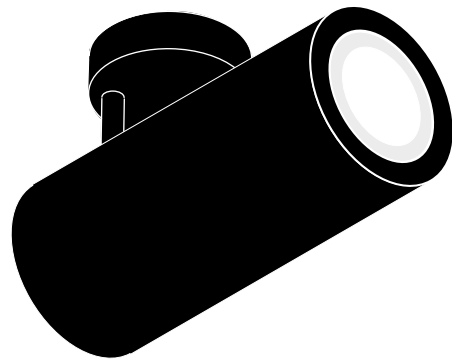
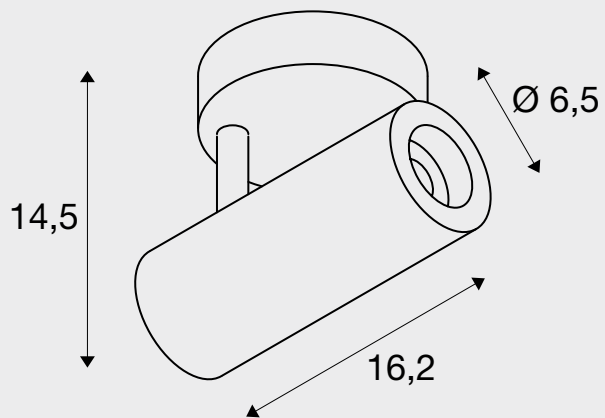

■ black

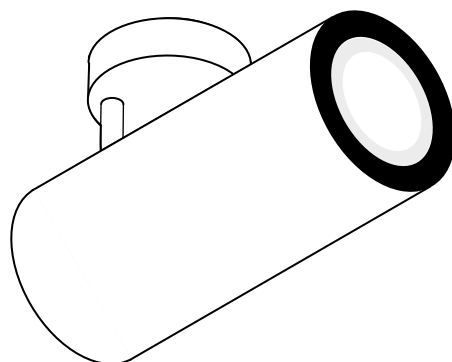

□ white





ITEM NO.



		985lm	24°	<b>1004098</b>
2700K		985lm	36°	<b>1004099</b>
		980lm	60°	<b>1004100</b>
		1020lm	24°	<b>1004106</b>
3000K		1020lm	36°	<b>1004107</b>
		1020lm	60°	<b>1004108</b>
		110lm	24°	<b>1004114</b>
4000K		110lm	36°	<b>1004115</b>
		110lm	60°	<b>1004116</b>



		985lm	24°	<b>1004386</b>
2700K		980lm	36°	<b>1004387</b>
		980lm	60°	<b>1004388</b>
		1020lm	24°	<b>1004394</b>
3000K		1020lm	36°	<b>1004395</b>
		1020lm	60°	<b>1004396</b>
		1090lm	24°	<b>1004402</b>
4000K		110lm	36°	<b>1004403</b>
		110lm	60°	<b>1004404</b>



		985lm	24°	<b>1004102</b>
2700K		985lm	36°	<b>1004103</b>
		980lm	60°	<b>1004104</b>
		1020lm	24°	<b>1004110</b>
3000K		1020lm	36°	<b>1004111</b>
		1020lm	60°	<b>1004112</b>
		110lm	24°	<b>1004118</b>
4000K		110lm	36°	<b>1004119</b>
		1090lm	60°	<b>1004120</b>



		985lm	24°	<b>1004390</b>
2700K		985lm	36°	<b>1004391</b>
		980lm	60°	<b>1004392</b>
		1020lm	24°	<b>1004398</b>
3000K		1020lm	36°	<b>1004399</b>
		1020lm	60°	<b>1004400</b>
		1090lm	24°	<b>1004406</b>
4000K		110lm	36°	<b>1004407</b>
		110lm	60°	<b>1004408</b>



# NUMINOS M



## CL

**Product details:**

220-240V ~50/60Hz | 500mA

Total wattage: 20.1W

Material: aluminium/plastic

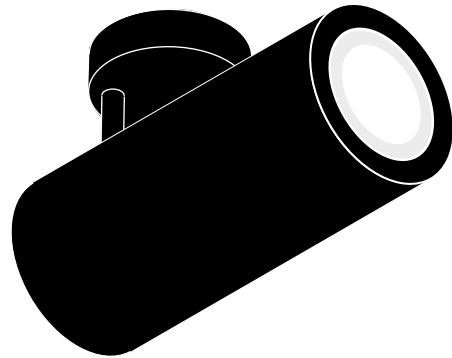
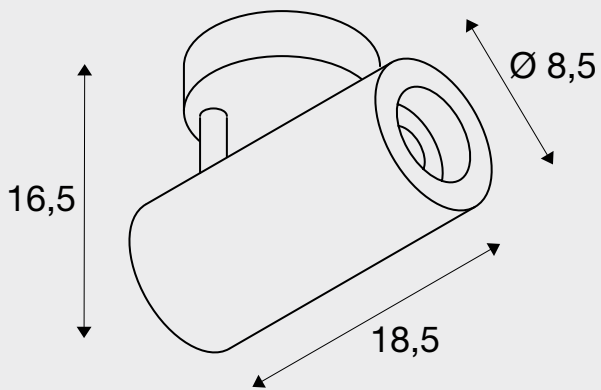

■ black

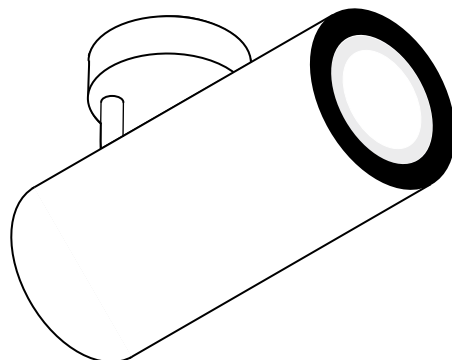

□ white



ITEM NO.



		1925lm	24°	<b>1004194</b>
2700K		1935lm	36°	<b>1004195</b>
		1870lm	60°	<b>1004196</b>
		1955lm	24°	<b>1004202</b>
3000K		1950lm	36°	<b>1004203</b>
		1870lm	60°	<b>1004204</b>
		2125lm	24°	<b>1004210</b>
4000K		21020lm	36°	<b>1004211</b>
		2060lm	60°	<b>1004212</b>



		1925lm	24°	<b>1004482</b>
2700K		1935lm	36°	<b>1004483</b>
		1885lm	60°	<b>1004484</b>
		1955lm	24°	<b>1004490</b>
3000K		1950lm	36°	<b>1004491</b>
		1880lm	60°	<b>1004492</b>
		2125lm	24°	<b>1004498</b>
4000K		21020lm	36°	<b>1004499</b>
		2060lm	60°	<b>1004500</b>



		1930lm	24°	<b>1004198</b>
2700K		1930lm	36°	<b>1004199</b>
		1885lm	60°	<b>1004200</b>
		1955lm	24°	<b>1004206</b>
3000K		1970lm	36°	<b>1004207</b>
		1880lm	60°	<b>1004208</b>
		2125lm	24°	<b>1004214</b>
4000K		21020lm	36°	<b>1004215</b>
		2060lm	60°	<b>1004216</b>



		1925lm	24°	<b>1004486</b>
2700K		1935lm	36°	<b>1004487</b>
		1885lm	60°	<b>1004488</b>
		1930lm	24°	<b>1004494</b>
3000K		1970lm	36°	<b>1004495</b>
		1880lm	60°	<b>1004496</b>
		21020lm	24°	<b>1004502</b>
4000K		21020lm	36°	<b>1004503</b>
		2060lm	60°	<b>1004504</b>



# NUMINOS L



## CL

**Product details:**

220-240V ~50/60Hz | 700mA

System output: 28W

Material: aluminium/plastic



50000 350° 90°

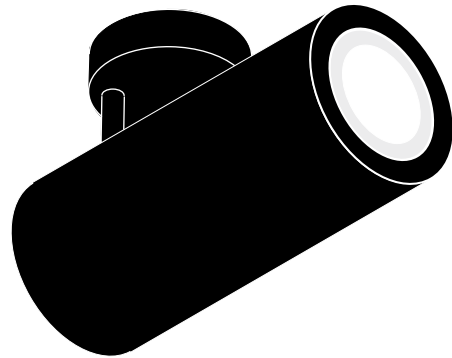
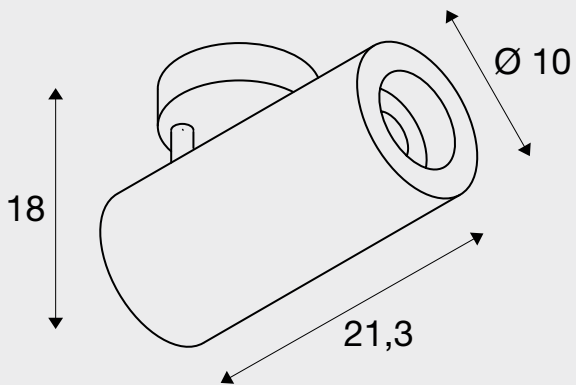

■ black

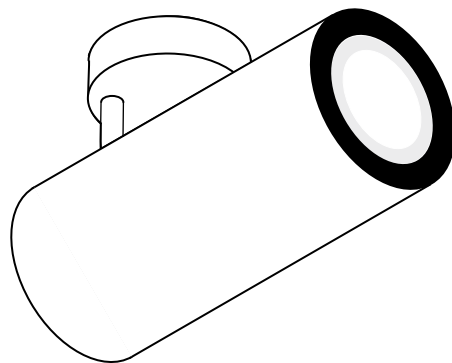

□ white



ITEM NO.



		2440lm	24°	<b>1004290</b>
2700K		2400lm	36°	<b>1004291</b>
		2475lm	60°	<b>1004292</b>
		2430lm	24°	<b>1004298</b>
3000K		2340lm	36°	<b>1004299</b>
		2400lm	60°	<b>1004300</b>
		2675lm	24°	<b>1004306</b>
4000K		2620lm	36°	<b>1004307</b>
		2715lm	60°	<b>1004308</b>



		2440lm	24°	<b>1004578</b>
2700K		2400lm	36°	<b>1004579</b>
		2475lm	60°	<b>1004580</b>
		2430lm	24°	<b>1004586</b>
3000K		2340lm	36°	<b>1004587</b>
		2400lm	60°	<b>1004588</b>
		2675lm	24°	<b>1004594</b>
4000K		2620lm	36°	<b>1004595</b>
		2715lm	60°	<b>1004596</b>



		2430lm	24°	<b>1004294</b>
2700K		2400lm	36°	<b>1004295</b>
		2475lm	60°	<b>1004296</b>
		2430lm	24°	<b>1004302</b>
3000K		2340lm	36°	<b>1004303</b>
		2400lm	60°	<b>1004304</b>
		2675lm	24°	<b>1004310</b>
4000K		2620lm	36°	<b>1004311</b>
		2720lm	60°	<b>1004312</b>



		2440lm	24°	<b>1004582</b>
2700K		2400lm	36°	<b>1004583</b>
		2475lm	60°	<b>1004584</b>
		2430lm	24°	<b>1004590</b>
3000K		2340lm	36°	<b>1004591</b>
		2400lm	60°	<b>1004592</b>
		2675lm	24°	<b>1004598</b>
4000K		2620lm	36°	<b>1004599</b>
		2715lm	60°	<b>1004600</b>



# NUMINOS S



## CL

**Product details:**

220-240V ~50/60Hz | 250mA

Total wattage: 10.42W

Material: aluminium/plastic

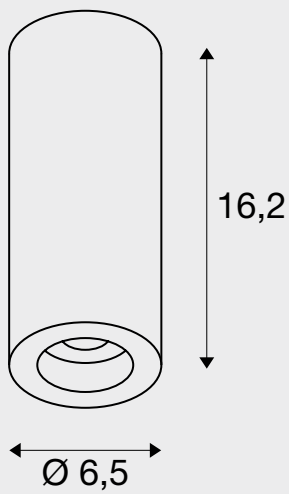

■ black

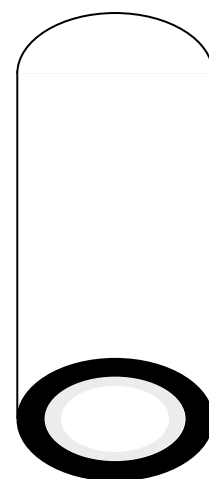

□ white



ITEM NO.



		985lm	24°	<b>1004122</b>
2700K		985lm	36°	<b>1004123</b>
		980lm	60°	<b>1004124</b>
		1020lm	24°	<b>1004130</b>
3000K		1020lm	36°	<b>1004131</b>
		1020lm	60°	<b>1004132</b>
		110lm	24°	<b>1004138</b>
4000K		110lm	36°	<b>1004139</b>
		110lm	60°	<b>1004140</b>



		985lm	24°	<b>1004410</b>
2700K		985lm	36°	<b>1004411</b>
		980lm	60°	<b>1004412</b>
		1020lm	24°	<b>1004418</b>
3000K		1020lm	36°	<b>1004419</b>
		1010lm	60°	<b>1004420</b>
		110lm	24°	<b>1004426</b>
4000K		110lm	36°	<b>1004427</b>
		110lm	60°	<b>1004428</b>



		980lm	24°	<b>1004126</b>
2700K		985lm	36°	<b>1004127</b>
		980lm	60°	<b>1004128</b>
		1010lm	24°	<b>1004134</b>
3000K		1020lm	36°	<b>1004135</b>
		2620lm	60°	<b>1004136</b>
		110lm	24°	<b>1004142</b>
4000K		110lm	36°	<b>1004143</b>
		1090lm	60°	<b>1004144</b>



		985lm	24°	<b>1004414</b>
2700K		980lm	36°	<b>1004415</b>
		980lm	60°	<b>1004416</b>
		1010lm	24°	<b>1004422</b>
3000K		1020lm	36°	<b>1004423</b>
		1020lm	60°	<b>1004424</b>
		110lm	24°	<b>1004430</b>
4000K		110lm	36°	<b>1004431</b>
		110lm	60°	<b>1004432</b>



# NUMINOS M



## CL

**Product details:**

220-240V ~50/60Hz | 500mA

Total wattage: 20.1W

Material: aluminium/plastic

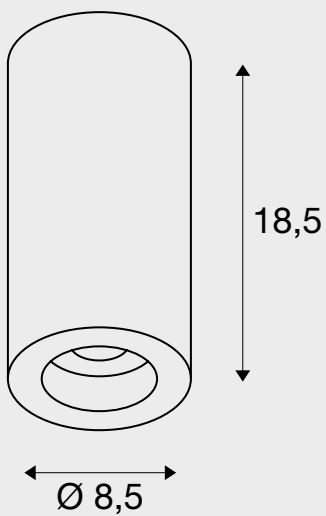

■ black

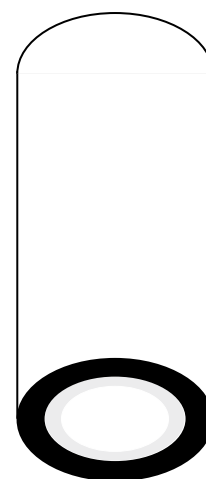

□ white





ITEM NO.



		1925lm	24°	<b>1004218</b>
2700K		1930lm	36°	<b>1004219</b>
		1870lm	60°	<b>1004220</b>
		1950lm	24°	<b>1004226</b>
3000K		1970lm	36°	<b>1004227</b>
		1880lm	60°	<b>1004228</b>
		2125lm	24°	<b>1004234</b>
4000K		21020lm	36°	<b>1004235</b>
		2060lm	60°	<b>1004236</b>



		1925lm	24°	<b>1004506</b>
2700K		1935lm	36°	<b>1004507</b>
		1885lm	60°	<b>1004508</b>
		1930lm	24°	<b>1004514</b>
3000K		1970lm	36°	<b>1004515</b>
		1870lm	60°	<b>1004516</b>
		2125lm	24°	<b>1004522</b>
4000K		21020lm	36°	<b>1004523</b>
		2060lm	60°	<b>1004524</b>



		1925lm	24°	<b>1004222</b>
2700K		1935lm	36°	<b>1004223</b>
		1885lm	60°	<b>1004224</b>
		1955lm	24°	<b>1004230</b>
3000K		1950lm	36°	<b>1004231</b>
		1870lm	60°	<b>1004232</b>
		2125lm	24°	<b>1004238</b>
4000K		21020lm	36°	<b>1004239</b>
		2060lm	60°	<b>1004240</b>



		1925lm	24°	<b>1004510</b>
2700K		1935lm	36°	<b>1004511</b>
		1885lm	60°	<b>1004512</b>
		1950lm	24°	<b>1004518</b>
3000K		1950lm	36°	<b>1004519</b>
		1880lm	60°	<b>1004520</b>
		2125lm	24°	<b>1004526</b>
4000K		21020lm	36°	<b>1004527</b>
		2060lm	60°	<b>1004528</b>



# NUMINOS L



## CL

**Product details:**

220-240V ~50/60Hz | 700mA

System output: 28W

Material: aluminium/plastic

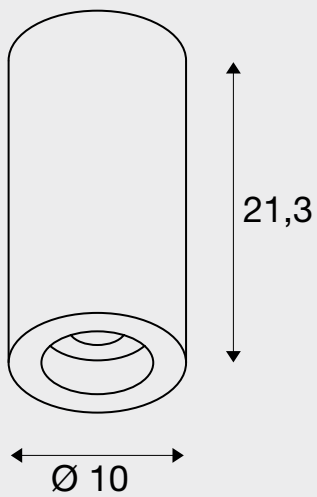

■ black

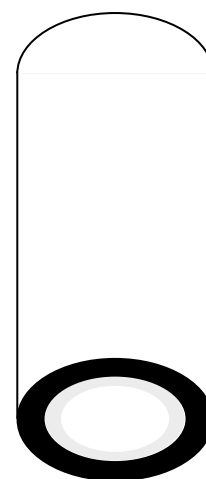

□ white



ITEM NO.

	2700K	2440lm	24°	<b>1004314</b>	
		2400lm	36°	<b>1004315</b>	
		2475lm	60°	<b>1004316</b>	
	3000K	2430lm	24°	<b>1004322</b>	
		2340lm	36°	<b>1004323</b>	
		2400lm	60°	<b>1004324</b>	
	4000K	2675lm	24°	<b>1004330</b>	
		2620lm	36°	<b>1004331</b>	
		2715lm	60°	<b>1004332</b>	

	2700K	2440lm	24°	<b>1004602</b>	
		2400lm	36°	<b>1004603</b>	
		2475lm	60°	<b>1004604</b>	
	3000K	2430lm	24°	<b>1004610</b>	
		2340lm	36°	<b>1004611</b>	
		2400lm	60°	<b>1004612</b>	
	4000K	2675lm	24°	<b>1004618</b>	
		2620lm	36°	<b>1004619</b>	
		2715lm	60°	<b>1004620</b>	

	2700K	2440lm	24°	<b>1004318</b>	
		2400lm	36°	<b>1004319</b>	
		2475lm	60°	<b>1004320</b>	
	3000K	2430lm	24°	<b>1004326</b>	
		2340lm	36°	<b>1004327</b>	
		2400lm	60°	<b>1004328</b>	
	4000K	2670lm	24°	<b>1004334</b>	
		2620lm	36°	<b>1004335</b>	
		2715lm	60°	<b>1004336</b>	

	2700K	2440lm	24°	<b>1004606</b>	
		2400lm	36°	<b>1004607</b>	
		2475lm	60°	<b>1004608</b>	
	3000K	2430lm	24°	<b>1004614</b>	
		2340lm	36°	<b>1004615</b>	
		2400lm	60°	<b>1004616</b>	
	4000K	2675lm	24°	<b>1004622</b>	
		2620lm	36°	<b>1004623</b>	
		2715lm	60°	<b>1004624</b>	

# NUMINOS S



## PD

**Product details:**

220-240V ~50/60Hz | 250mA

Total wattage: 10.42W

Material: aluminium/plastic

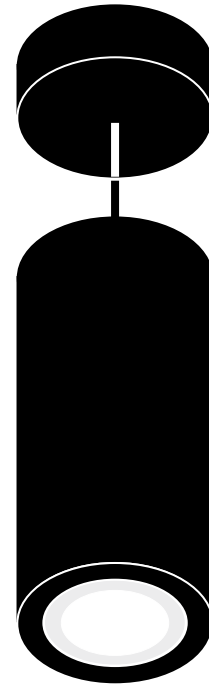
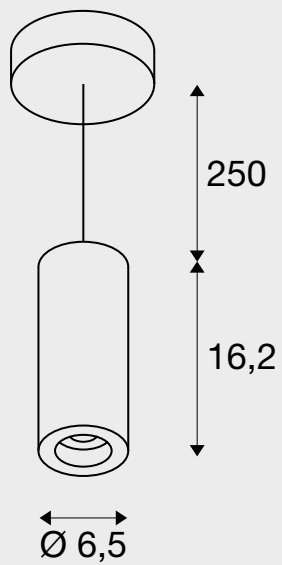

■ black

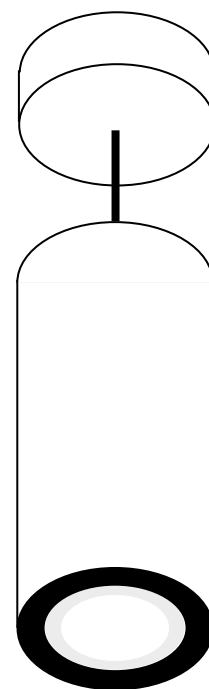

□ white



ITEM NO.



2700K	980lm	24°	<b>1004146</b>
	985lm	36°	<b>1004147</b>
	980lm	60°	<b>1004148</b>
3000K	1020lm	24°	<b>1004154</b>
	1020lm	36°	<b>1004155</b>
	1020lm	60°	<b>1004156</b>
4000K	110lm	24°	<b>1004162</b>
	110lm	36°	<b>1004163</b>
	110lm	60°	<b>1004164</b>



2700K	985lm	24°	<b>1004434</b>
	985lm	36°	<b>1004435</b>
	980lm	60°	<b>1004436</b>
3000K	1020lm	24°	<b>1004442</b>
	1020lm	36°	<b>1004443</b>
	1020lm	60°	<b>1004444</b>
4000K	110lm	24°	<b>1004450</b>
	110lm	36°	<b>1004451</b>
	110lm	60°	<b>1004452</b>



2700K	985lm	24°	<b>1004150</b>
	985lm	36°	<b>1004151</b>
	980lm	60°	<b>1004152</b>
3000K	1020lm	24°	<b>1004158</b>
	1020lm	36°	<b>1004159</b>
	1020lm	60°	<b>1004160</b>
4000K	110lm	24°	<b>1004166</b>
	110lm	36°	<b>1004167</b>
	110lm	60°	<b>1004168</b>



2700K	985lm	24°	<b>1004438</b>
	985lm	36°	<b>1004439</b>
	980lm	60°	<b>1004440</b>
3000K	1020lm	24°	<b>1004446</b>
	1020lm	36°	<b>1004447</b>
	1020lm	60°	<b>1004448</b>
4000K	110lm	24°	<b>1004454</b>
	110lm	36°	<b>1004455</b>
	110lm	60°	<b>1004456</b>



# NUMINOS M



## PD

**Product details:**

220-240V ~50/60Hz | 500mA

Total wattage: 20.1W

Material: aluminium/plastic

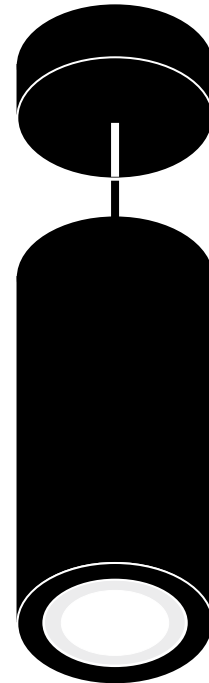
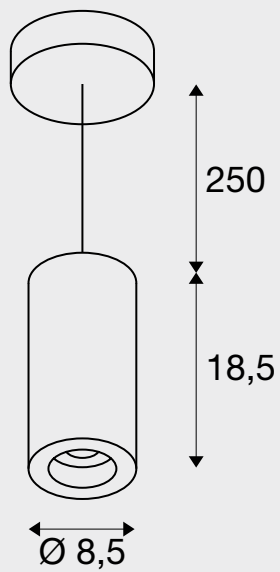

black

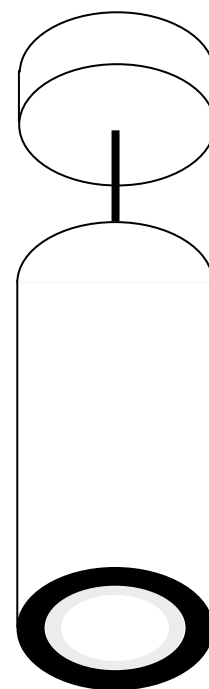

white



ITEM NO.



		1925lm	24°	<b>1004242</b>
2700K		1935lm	36°	<b>1004243</b>
		1885lm	60°	<b>1004244</b>
		1955lm	24°	<b>1004250</b>
3000K		1970lm	36°	<b>1004251</b>
		1870lm	60°	<b>1004252</b>
		2125lm	24°	<b>1004258</b>
4000K		21020lm	36°	<b>1004259</b>
		2060lm	60°	<b>1004260</b>



		1925lm	24°	<b>1004530</b>
2700K		1935lm	36°	<b>1004531</b>
		1885lm	60°	<b>1004532</b>
		1955lm	24°	<b>1004538</b>
3000K		1970lm	36°	<b>1004539</b>
		1880lm	60°	<b>1004540</b>
		2125lm	24°	<b>1004546</b>
4000K		21020lm	36°	<b>1004547</b>
		2060lm	60°	<b>1004548</b>



		1925lm	24°	<b>1004246</b>
2700K		1935lm	36°	<b>1004247</b>
		1885lm	60°	<b>1004248</b>
		1955lm	24°	<b>1004254</b>
3000K		1950lm	36°	<b>1004255</b>
		1880lm	60°	<b>1004256</b>
		2125lm	24°	<b>1004262</b>
4000K		21020lm	36°	<b>1004263</b>
		2060lm	60°	<b>1004264</b>



		1930lm	24°	<b>1004534</b>
2700K		1935lm	36°	<b>1004535</b>
		1885lm	60°	<b>1004536</b>
		1955lm	24°	<b>1004542</b>
3000K		1970lm	36°	<b>1004543</b>
		1870lm	60°	<b>1004544</b>
		2125lm	24°	<b>1004550</b>
4000K		21020lm	36°	<b>1004551</b>
		2060lm	60°	<b>1004552</b>



# NUMINOS L



## PD

**Product details:**

220-240V ~50/60Hz | 700mA

System output: 28W

Material: aluminium/plastic

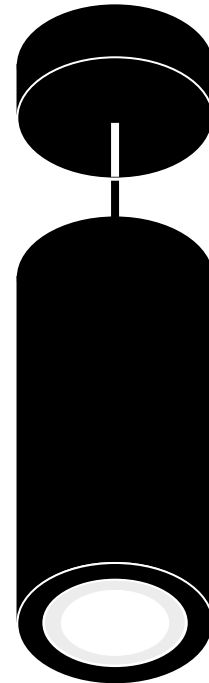
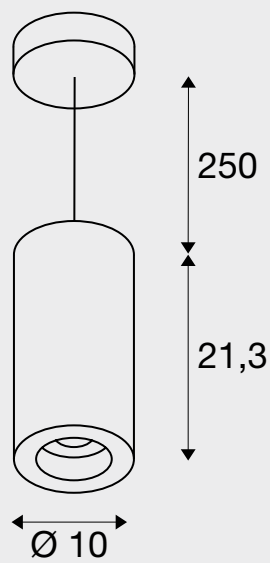

■ black

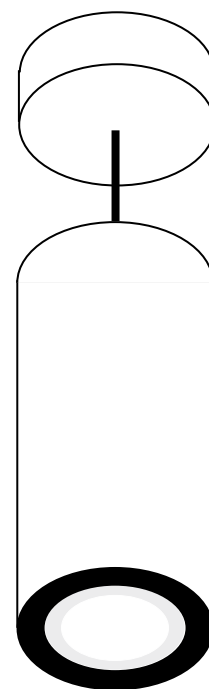

□ white





ITEM NO.



		2440lm	24°	<b>1004338</b>
2700K		2400lm	36°	<b>1004339</b>
		2475lm	60°	<b>1004340</b>
		2430lm	24°	<b>1004346</b>
3000K		2340lm	36°	<b>1004347</b>
		2400lm	60°	<b>1004348</b>
		2670lm	24°	<b>1004354</b>
4000K		2620lm	36°	<b>1004355</b>
		2715lm	60°	<b>1004356</b>



		2430lm	24°	<b>1004626</b>
2700K		2400lm	36°	<b>1004627</b>
		2475lm	60°	<b>1004628</b>
		2430lm	24°	<b>1004634</b>
3000K		2340lm	36°	<b>1004635</b>
		2400lm	60°	<b>1004636</b>
		2675lm	24°	<b>1004642</b>
4000K		2620lm	36°	<b>1004643</b>
		2715lm	60°	<b>1004644</b>



		2440lm	24°	<b>1004342</b>
2700K		2400lm	36°	<b>1004343</b>
		2475lm	60°	<b>1004344</b>
		2430lm	24°	<b>1004350</b>
3000K		2340lm	36°	<b>1004351</b>
		2400lm	60°	<b>1004352</b>
		2670lm	24°	<b>1004358</b>
4000K		2620lm	36°	<b>1004359</b>
		2720lm	60°	<b>1004360</b>



		2440lm	24°	<b>1004630</b>
2700K		2400lm	36°	<b>1004631</b>
		2475lm	60°	<b>1004632</b>
		2430lm	24°	<b>1004638</b>
3000K		2340lm	36°	<b>1004639</b>
		2400lm	60°	<b>1004640</b>
		2675lm	24°	<b>1004646</b>
4000K		2620lm	36°	<b>1004647</b>
		2715lm	60°	<b>1004648</b>





# TIMELESS CLASSIC

SUITABLE TABLE LAMPS AND FLOOR STANDS  
FOR ANY ROOM.

---

The classic among the luminaires: our table lamps and floor stands blend into any interior thanks to their simple, slim design and therefore always make a good impression in offices, living areas and stores.

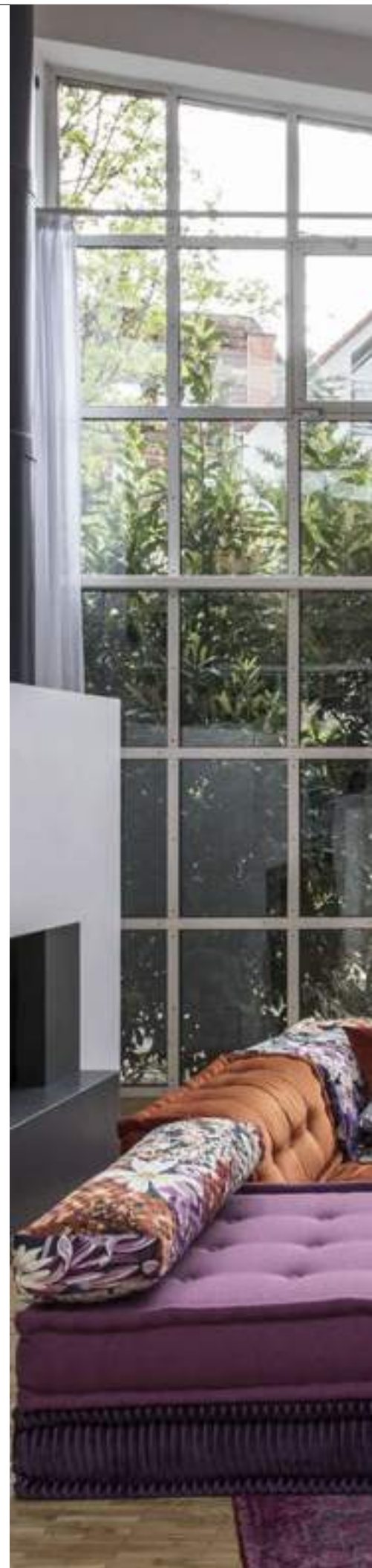



1000763 + 1000764 79 + 81



1002146 85

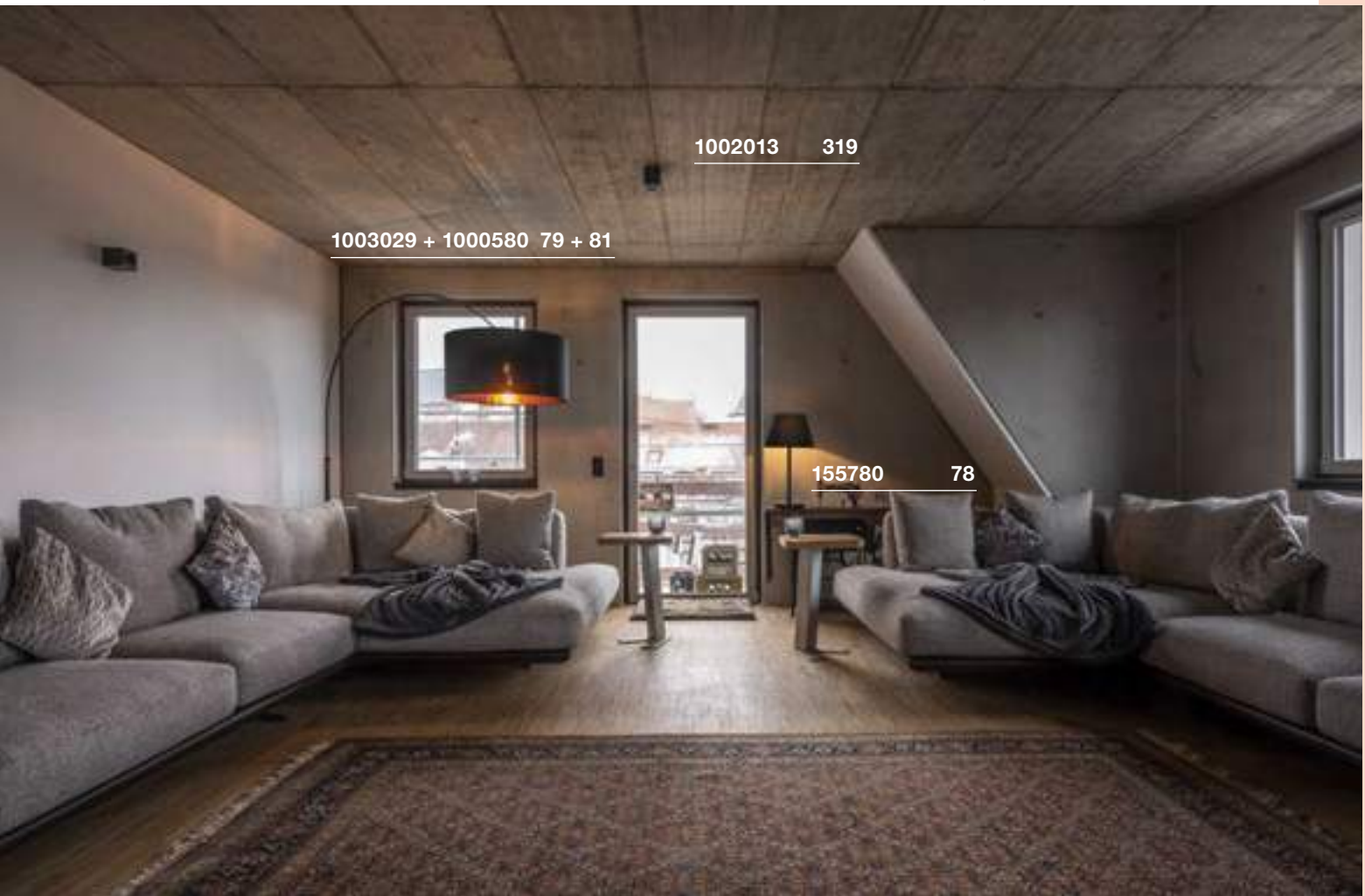

TABLE AND FLOOR LAMPS



Other luminaires and variants can be found online at [www.slv.com](http://www.slv.com)  
 You can find manufacturer's details for our recommended lamps in the chapter 'Lightbulbs', from page 844

FITU  
TL, E27



SOCKET  
INSIDE



- Switch located on the power cord

Product details

220-240V ~50/60Hz  
Material: aluminium



Dimensional drawing

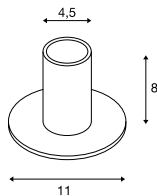

Tip

Euro plug and switch

Recommended lamp

LED E27 7W  
2700K 440lm  
7kWh/1000h  
Item No. 1003092



LED E27 7W  
2700K 640lm  
7kWh/1000h  
Item No. 1003085



Lamp details

max. 10W

Variant	Item No.
E27	
■ black	1001676
E27	
□ white	1001677
E27	
▨ aluminium	1001678



1001676 70



1001676 70

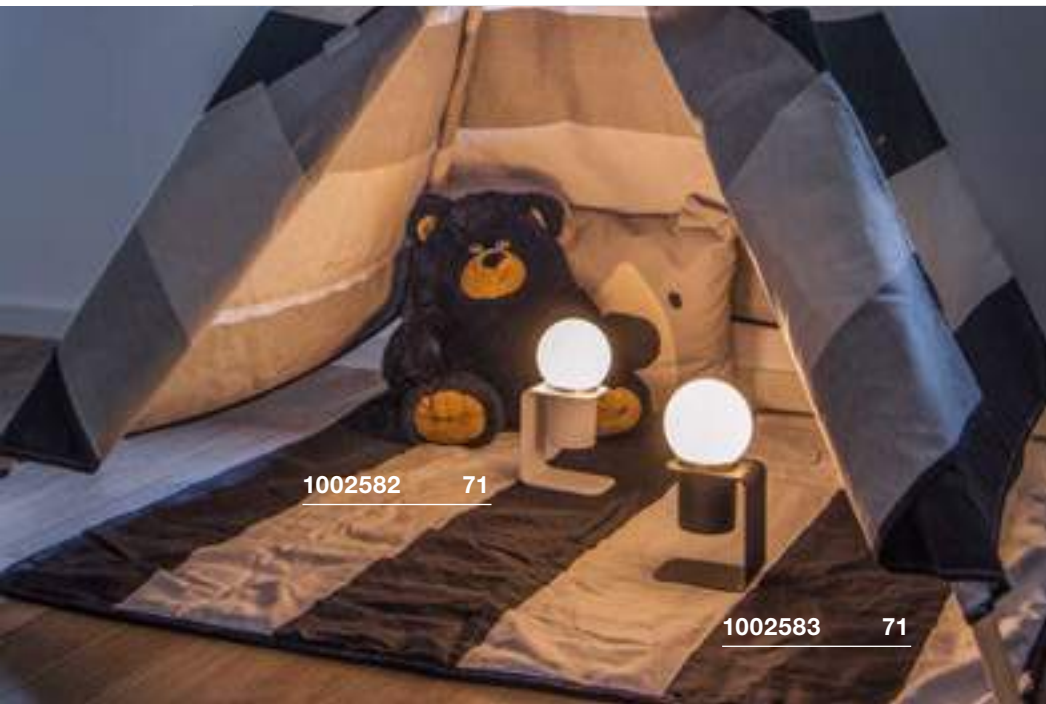

1002582 71

1002583 71

TONILA  
TLLED  
INSIDE

- Mobile, cordless light
- Can be dimmed to 3 different levels using the switch
- Convenient USB charging

## Product details

Battery operation  
Total wattage: 1.6W  
Material: aluminium/plastic  
Dimmable: switch



## Dimensional drawing

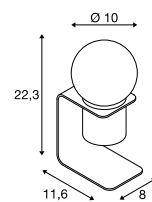

## Tip

Power adapter excl. USB charger 5V DC/1-2A required.  
For MINI-USB charging cable



1002583 71

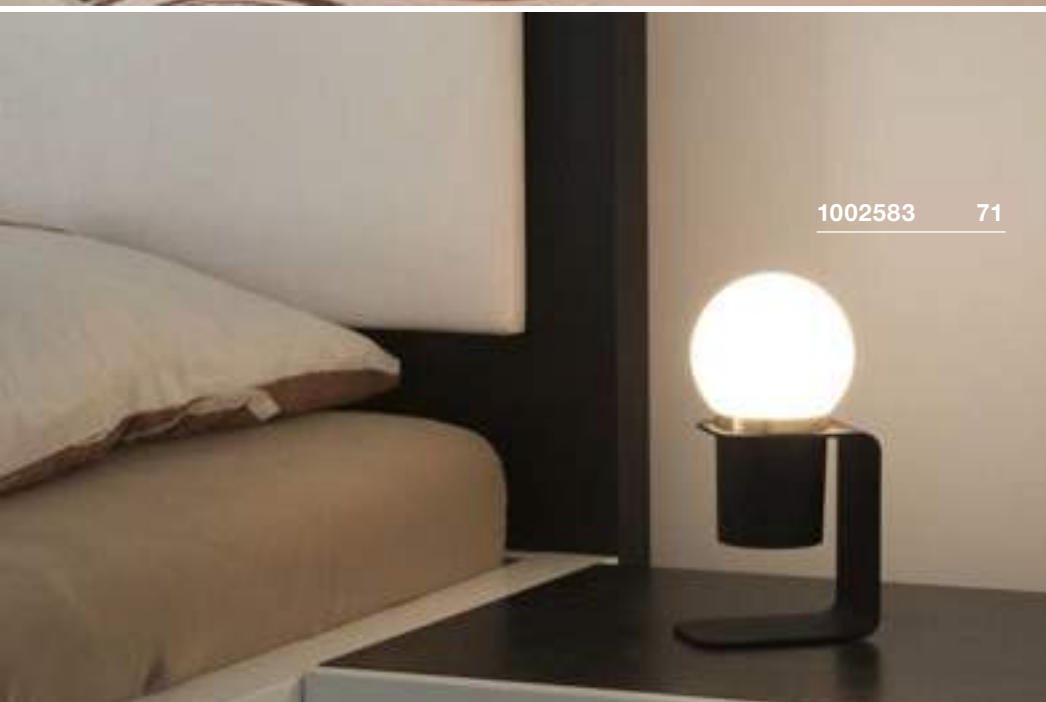

1002583 71

Variant	Item No.
90lm   2700K   CRI>80	
white/aluminium	1002582
90lm   2700K   CRI>80	
black/copper	1002583

MAGANDA  
TL

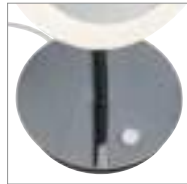

- 3-times optical magnification
- Select from 3 light colours
- Touch sensitive switch

Product details

100-240V ~50/60Hz | 12V DC  
Total wattage: 4.8W  
Material: steel/glass

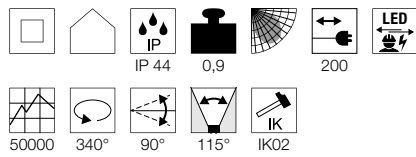

Dimensional drawing

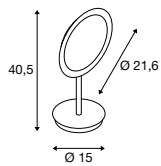

Tip

IP Safety plug

VINCELLI D  
TL



- Slim design
- Light body made of real bamboo

Product details

220-240V ~50Hz | 500mA  
Total wattage: 12W  
Material: bamboo/steel

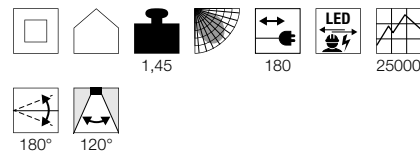

Dimensional drawing

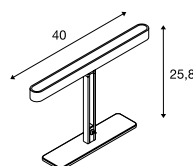

Tip

Plug-in power supply

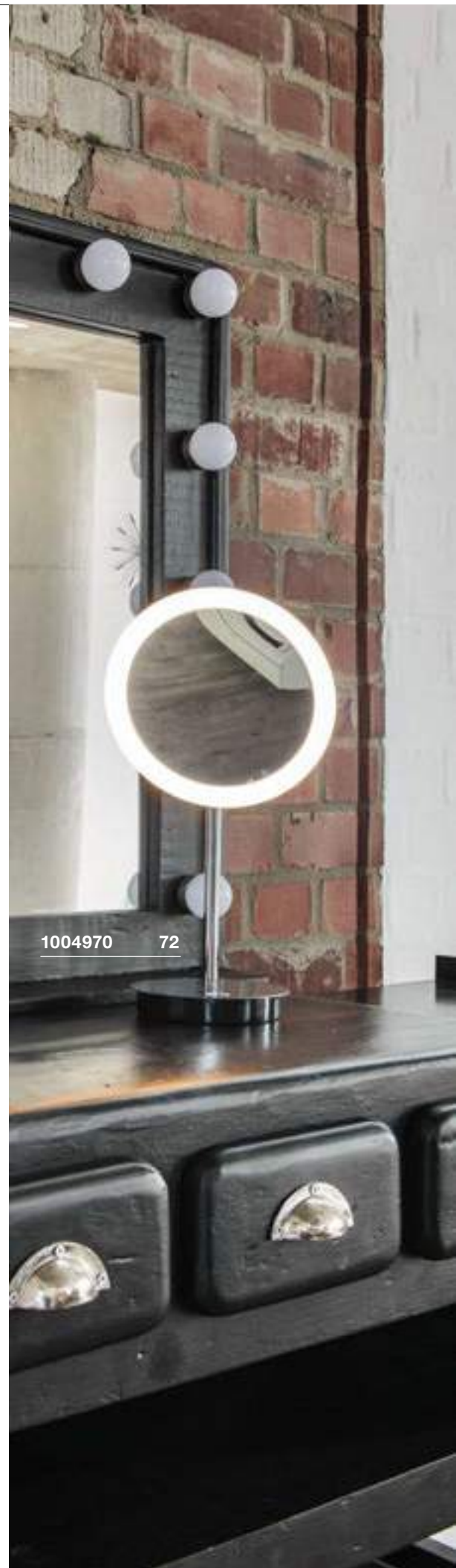

Variant	Item No.
45/48/51lm   2700/3000/4000K   CRI>90 ■ chrome	1004970

Variant	Item No.
500lm   2700K   CRI>80 ■ anthracite/brown	1002068





1004970 72



1002068 73



146111

75



**DESIGNED BY**

Johannes Tomm





146111 75

**BRENDA**  
TL, Wireless chargingreddot award 2018  
winner

- Can be dimmed to 3 levels using the switch
- Charging surface for cordless smartphone charging
- USB connection

**Product details**

220-240V ~50/60Hz | 12V DC  
 Total wattage: 11W  
 Material: aluminium/glass  
 Dimmable: switch



1,58

200



50000

IK03

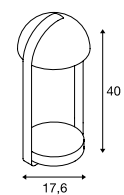
**Dimensional drawing****Tip**

Nightlight with a separate switch  
 Euro plug

**Variant****Item No.**

Indirect:: 460lm | 3000K | CRI>80  
 Night light: 50lm | 3000K | CRI>80

white/aluminium

146111

# SLV FENDA. MIX & MATCH.

MIX & match

MIX & MATCH Video

[bit.ly/slv-mix-match](https://bit.ly/slv-mix-match)





1003032 + 155582 79 + 80



1003029 + 156122 79 + 81



1003030 + 156141 78 + 80

FENDA  
TL, E27



SOCKET  
INSIDE



MIX &  
match

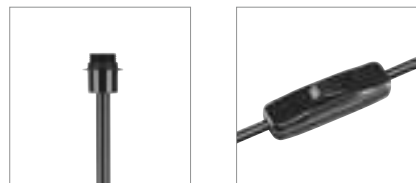

- Can be individually altered through the selection of a suitable lampshade
- Switch located on the power cord

Product details

220-240V ~50/60Hz  
Material: steel



1,95 200

Dimensional drawing

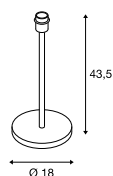

Tip

Euro plug and switch

Recommended lamp

LED E27 14,5W 200°  
2700K 1521lm  
15kWh/1000h  
Item No. 560422



LED E27 7W  
2700K 810lm  
7kWh/1000h  
Item No. 1003090



Lamp details

max. 60W

Variant	Item No.
E27 □ matt white	1003030
E27 ■ matt black	155780
E27 ■ brushed nickel	155785

FENDA  
FL, E27



SOCKET  
INSIDE



MIX &  
match

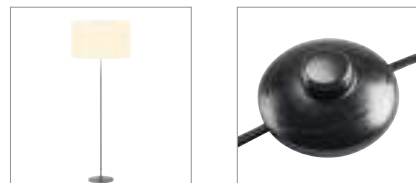

- Can be individually altered through the selection of a suitable lampshade
- Foot switch located on the power cord

Product details

220-240V ~50/60Hz  
Material: steel



5,1 200

Dimensional drawing

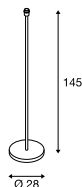

Tip

Euro plug and switch

Recommended lamp

LED E27 9,1W 240°  
2700K 760lm  
10kWh/1000h  
Item No. 560402



LED E27 7W 280°  
2700K 790lm  
7kWh/1000h  
Item No. 1002127



Lamp details

max. 60W

Variant	Item No.
E27 □ matt white	1003031
E27 ■ matt black	155790
E27 ■ brushed nickel	155795



1003030 + 155582 78 + 80

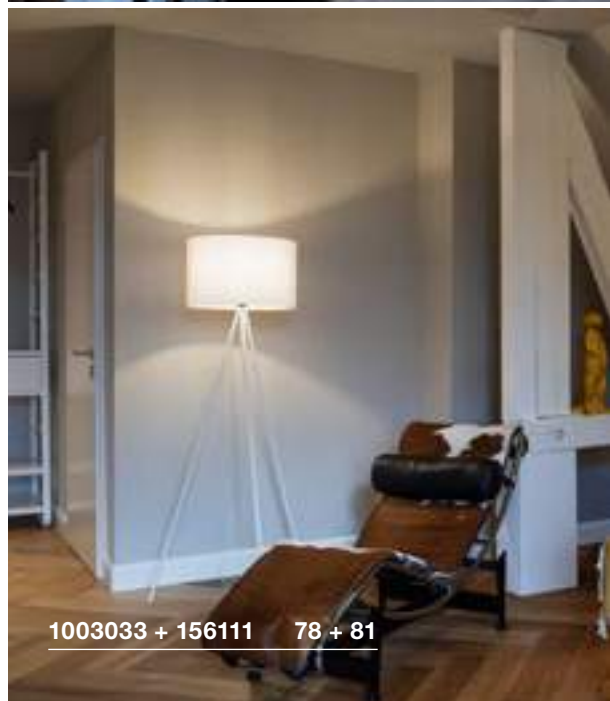

1003033 + 156111 78 + 81

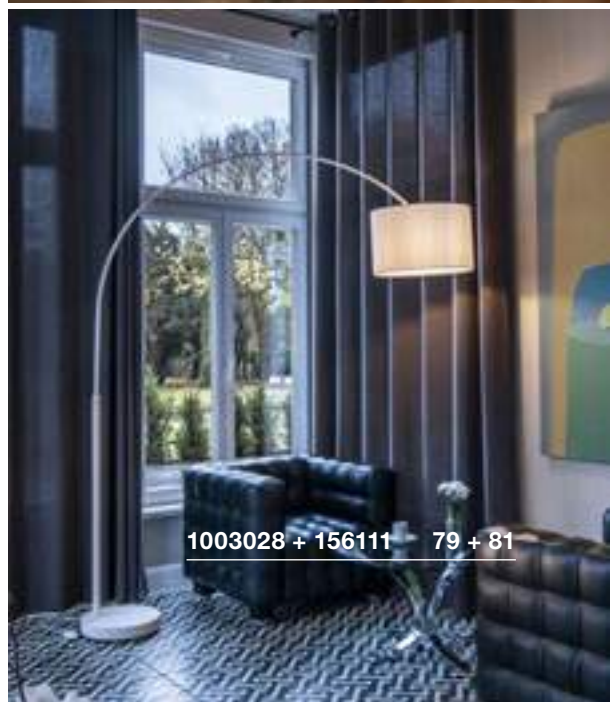

1003028 + 156111 79 + 81



FENDA TL, E27



SOCKET INSIDE



MIX & MATCH



- Can be individually altered through the selection of a suitable lampshade
- Switch located on the power cord

Product details

220-240V ~50/60Hz  
Material: aluminium



Dimensional drawing

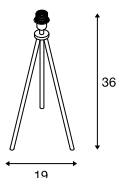

Tip

Euro plug

Recommended lamp

LED E27 5W 330°  
2000K 500lm  
5kWh/1000h  
Item No. 560741



LED E27 7W 280°  
2200-2700K 830lm  
7kWh/1000h  
Item No. 1002126



Lamp details

max. 40W

Variant	Item No.
E27	
□ matt white	1003032
E27	
■ matt black	155540

FENDA FL, E27



SOCKET INSIDE



MIX & MATCH

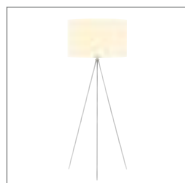

- Can be individually altered through the selection of a suitable lampshade
- Switch on light body

Product details

220-240V ~50/60Hz  
Material: aluminium



Dimensional drawing

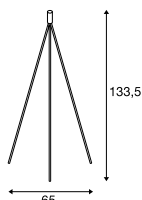

Tip

Euro plug

Recommended lamp

LED E27 9,1W 240°  
2700K 760lm  
10kWh/1000h  
Item No. 560402



LED E27 7W  
2700K 810lm  
7kWh/1000h  
Item No. 1003090



Lamp details

max. 40W

Variant	Item No.
E27	
□ matt white	1003033
E27	
■ matt black	155490
E27	
■ chrome	155492

FENDA BOW BASE FL, E27



SOCKET INSIDE



MIX & MATCH

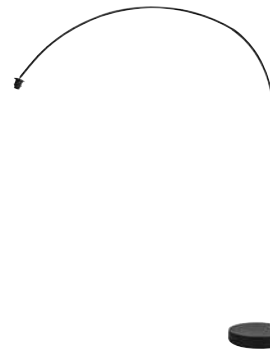

- Can be individually altered through the selection of a suitable lampshade
- Foot switch located on the power cord

Product details

220-240V ~50/60Hz  
Material: steel

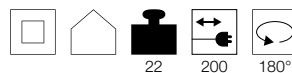

Dimensional drawing

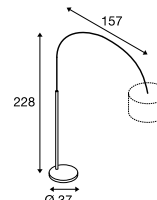

Tip

max. shade weight 900g  
Euro plug and switch

Recommended lamp

LED E27 14,5W 200°  
2700K 1521lm  
15kWh/1000h  
Item No. 560422



LED E27 7W 280°  
2700K 790lm  
7kWh/1000h  
Item No. 1002124



Lamp details

max. 25W  
L: 17.5 cm max.

Variant	Item No.
E27	
□ matt white	1003028
E27	
■ matt black	1003029
E27	
■ chrome	1000763



FENDA  
diameter 15 cm, round



- Can be individually altered through the selection of a suitable light base

Product details

Material: textile/steel



Dimensional drawing

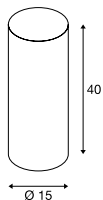

Tip

max. 40W

FENDA  
Diameter 30 cm, round



- Can be individually altered through the selection of a suitable light base

Product details

Material: textile/steel



Dimensional drawing

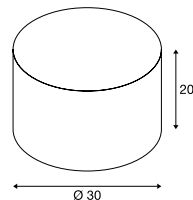

Tip

max. 60W

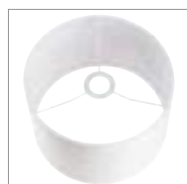

Variant	Item No.
white	156141
beige	156143
black/copper	156152

Variant	Item No.
white	155582
beige	155583
black/copper	155592

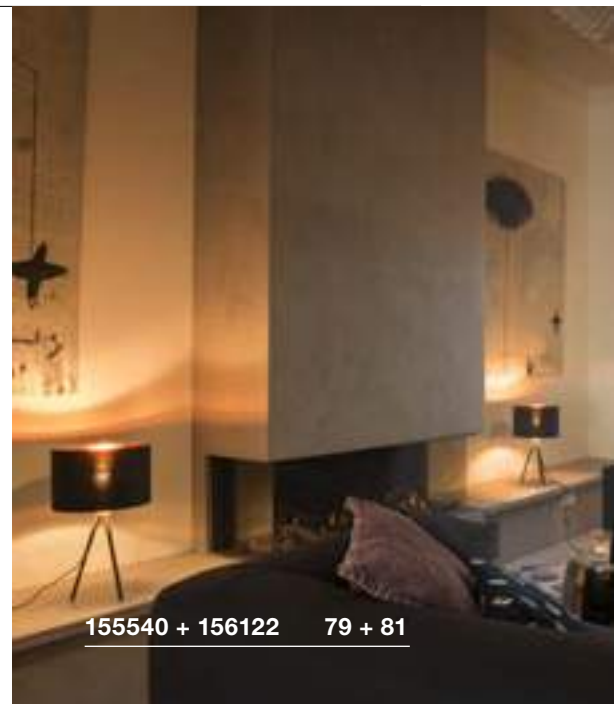

155540 + 156122 79 + 81

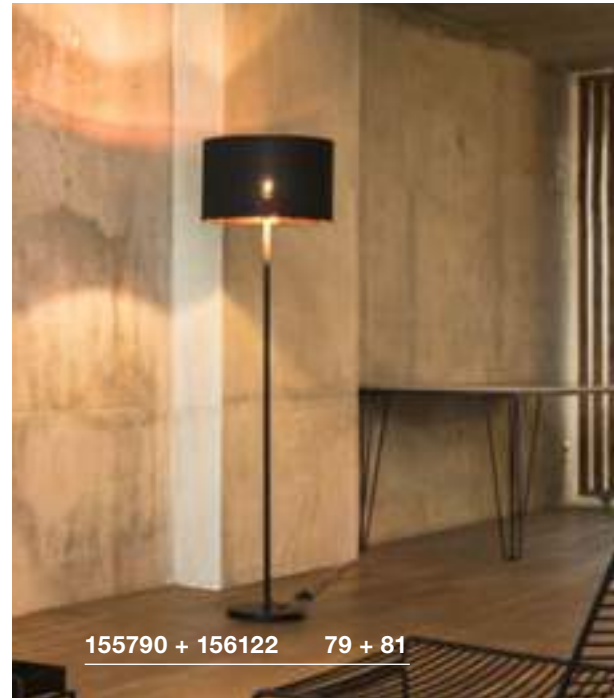

155790 + 156122 79 + 81



1000763 + 1000764 79 + 81





FENDA  
diameter 45 cm, round



- Can be individually altered through the selection of a suitable light base

Product details

Material: textile/steel



Dimensional drawing

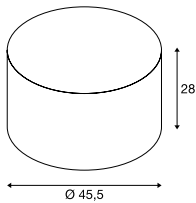

Tip

max. 60W



Accessory recommendation

- Acrylic glass cover  
Item No. 156100



Variant	Item No.
<input type="checkbox"/> white	156111
<input type="checkbox"/> beige	156113
<input type="checkbox"/> black/copper	156122

FENDA  
diameter 70 cm, round

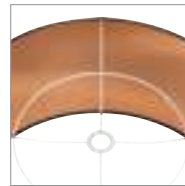

- Can be individually altered through the selection of a suitable light base

Product details

Material: textile/steel



Dimensional drawing

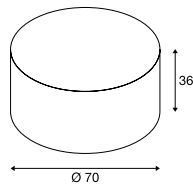

Tip

max. 60W



Variant	Item No.
<input type="checkbox"/> white	1000579
<input type="checkbox"/> black/copper	1000580

FENDA  
diameter 40 cm, round



- Can be individually altered through the selection of a suitable light base

Product details

Material: Polymethylacrylate (PMMA)

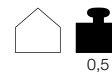

Dimensional drawing

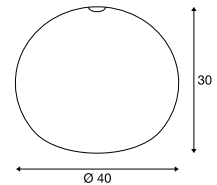

Tip

max. 60W



Variant	Item No.
<input type="checkbox"/> glossy white	1000764

KARPO  
TL



- Premium LED with CRI>90
- Switch located on light head
- Can be dimmed to 3 different levels using the switch

Product details

100-240V ~50/60Hz | 500mA  
 Total wattage: 6.5W  
 Material: aluminium  
 Dimmable: switch

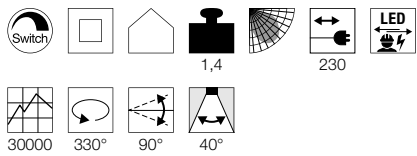

Dimensional drawing

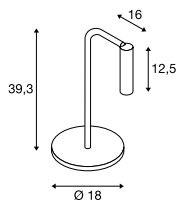

1001461 82



1001463 83



Variant	Item No.
400lm   3000K   CRI>90	
□ matt white	1001460
330lm   3000K   CRI>90	
■ matt black	1001461



1001462 83

KARPO  
FLLED  
INSIDE

- Premium LED with CRI>90
- Switch located on light head
- Can be dimmed to 3 different levels using the switch

**Product details**

100-240V ~50/60Hz | 500mA  
 Total wattage: 6.5W  
 Material: aluminium  
 Dimmable: switch

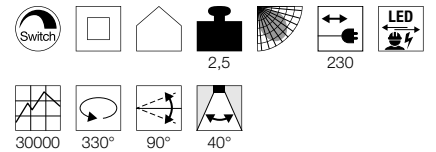
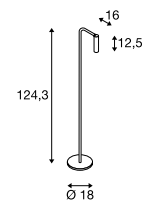
**Dimensional drawing**

Variant	Item No.
400lm   3000K   CRI>90 □ matt white	1001462
330lm   3000K   CRI>90 ■ matt black	1001463

**PHELIA**  
TL, QPAR51



SOCKET  
INSIDE



- Switch on light body
- Head can be rotated 90°
- Lampshade painted white on the inside

**Product details**

230V ~50/60Hz  
Material: aluminium/steel

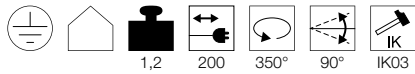

**Dimensional drawing**

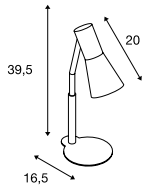

**Tip**

Safety plug and switch

**Recommended lamp**

LED GU10 4W  
2600K 260lm  
4kWh/1000h  
**Item No. 1003101**



LED GU10 6W 36°  
2700K 460lm  
6kWh/1000h  
**Item No. 1005076**



**Lamp details**

max. 35W QPAR51  
Diameter: 5 cm max. L: 10.5 cm max.

Variant	Item No.
GU10   QPAR51	
■ matt black/chrome	146000

**PHELIA**  
FL, E27



SOCKET  
INSIDE



- Switch on light body
- Head can be rotated 90°
- Lampshade painted white on the inside

**Product details**

230V ~50/60Hz  
Material: aluminium/steel

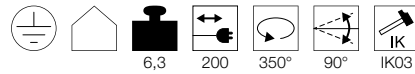

**Dimensional drawing**

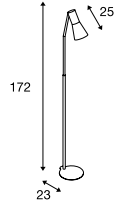

**Tip**

Safety plug and switch

**Recommended lamp**

LED E27 8W 350°  
2200K 250lm  
8kWh/1000h  
**Item No. 1003100**



LED E27 7W 280°  
2700K 790lm  
7kWh/1000h  
**Item No. 1002127**



**Lamp details**

max. 23 W  
Diameter: 5.3 cm max. L: 18 cm max.

Variant	Item No.
E27	
■ matt black/chrome	146010

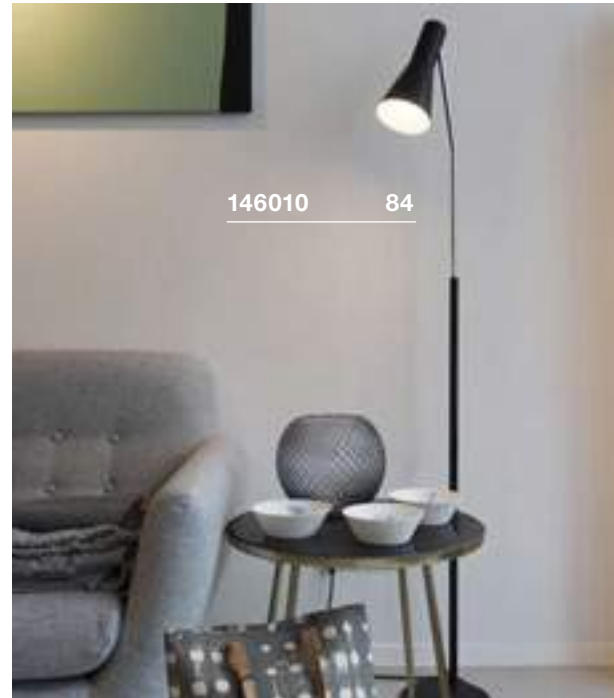



1002149 200

1002150 85

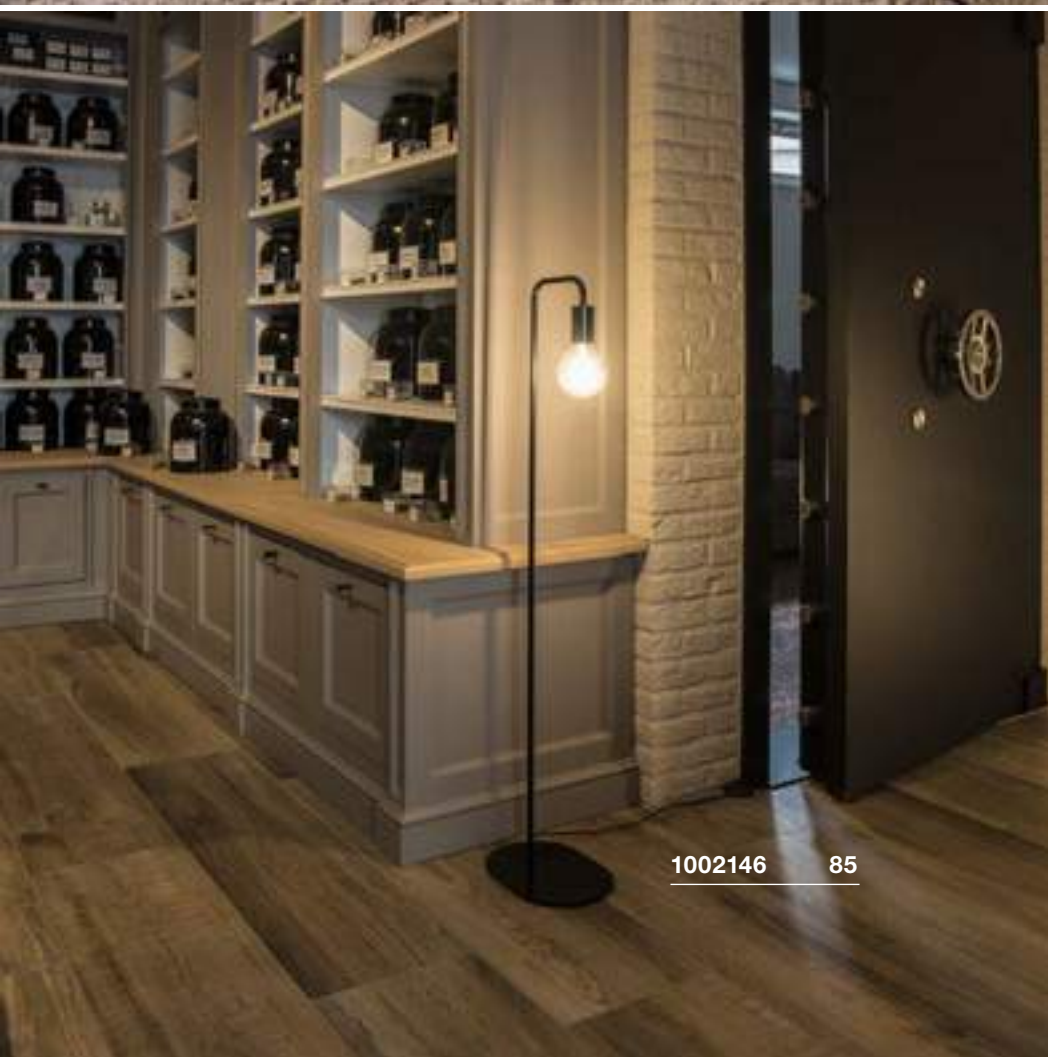

1002146 85

FITU  
FL, E27



SOCKET  
INSIDE



- Foot switch located on the power cord

Product details

220-240V ~50/60Hz  
Material: aluminium/steel



Dimensional drawing

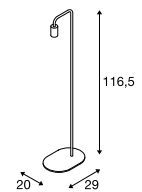

Tip

Euro plug and switch

Recommended lamp

LED E27 8W 350°  
2200K 250lm  
8kWh/1000h  
Item No. 1003100



LED E27 7W  
2700K 440lm  
7kWh/1000h  
Item No. 1003092



Lamp details

max. 24 W

Variant	Item No.
E27	
□ matt white	1002145
E27	
■ matt black	1002146
E27	
■ matt gold	1002150



### MECANICA PLUS TL



- Dimming function and colour tuning

#### Product details

100-240V ~50/60Hz | 12V DC  
 Total wattage: 7W  
 Material: aluminium  
 Dimmable: switch

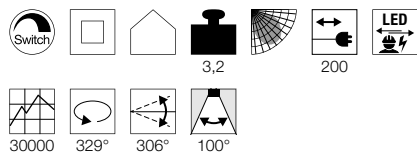

#### Dimensional drawing

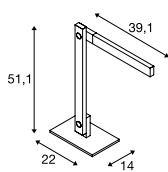

#### Tip

Plug-in power supply

### MECANICA PLUS FL

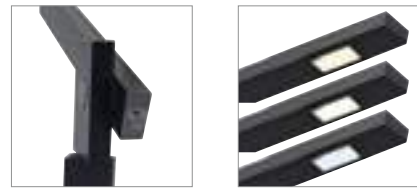

- Dimming function and colour tuning

#### Product details

100-240V ~50/60Hz | 12V DC  
 Total wattage: 7W  
 Material: aluminium  
 Dimmable: switch

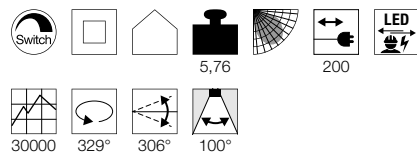

#### Dimensional drawing

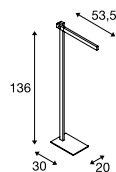

#### Tip

Plug-in power supply

Variant	Item No.
450lm   2700-6500K   CRI>80 ■ matt black	1002404

Variant	Item No.
450lm   2700-6500K   CRI>80 ■ matt black	1002405

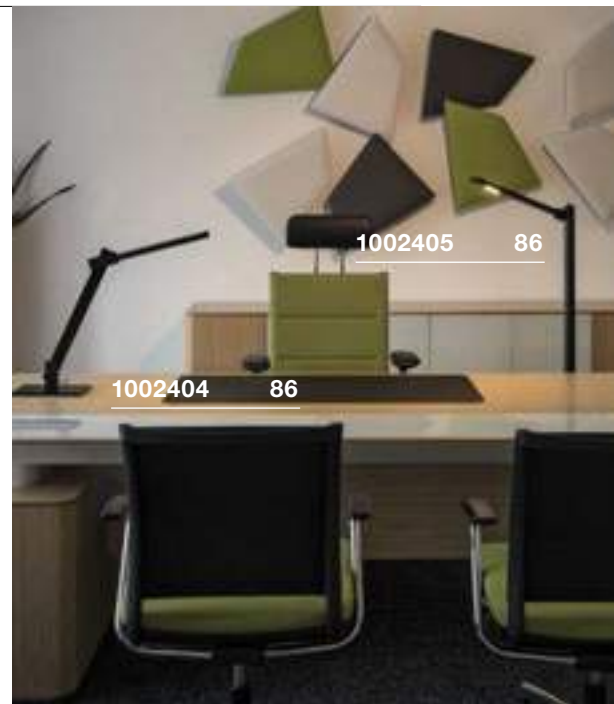

1002405 86  
 1002404 86



1002405 86



1002405 86



LIGHT PIPE 60/90/140  
Pole, PHASE



- Suitable for indoor and outdoor use

Product details

220-240V ~50/60Hz  
Total wattage: 11W  
Material: aluminium/polymethylacrylate (PMMA)  
Dimmable: C, L



Dimensional drawing

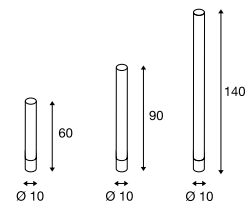

Tip

The lights are delivered without a mounting plate  
Indoor mounting plate with foot switch located on the power cord  
Outdoor mounting plate without switch, with IP44 safety plug

Accessory recommendation

Earthspike

Item No. 234430

Mounting plate outdoor

Item No. 234431

Mounting plate indoor

Item No. 234441



Variant	Item No.
630lm   2700K   CRI>80   H: 60 cm   1.5 kg <input type="checkbox"/> white	234401
630lm   2700K   CRI>80   H: 90 cm   1.71 kg <input type="checkbox"/> white	234411
630lm   2700K   CRI>80   H: 140 cm   2.06 kg <input type="checkbox"/> white	234421

WORKLIGHT  
FL



- Direct and indirect light

Product details

220-240V ~50/60Hz | 226mA  
Total wattage: 35W  
Material: aluminium/acrylic

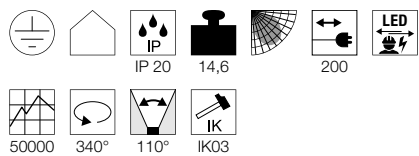

Dimensional drawing

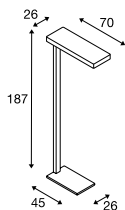

Tip

Switch located on the light shaft  
Safety plug

Variant	Item No.
Direct: 1850lm   3000K   CRI>80 Indirect: 1850lm   3000K   CRI>80 □ matt white	<b>157901</b>
Direct: 1850lm   3000K   CRI>80 Indirect: 1850lm   3000K   CRI>80 ■ matt anthracite	<b>157905</b>
Direct: 1850lm   4000K   CRI>80 Indirect: 1850lm   4000K   CRI>80 □ matt white	<b>1003520</b>
Direct: 1850lm   4000K   CRI>80 Indirect: 1850lm   4000K   CRI>80 ■ matt anthracite	<b>1003521</b>

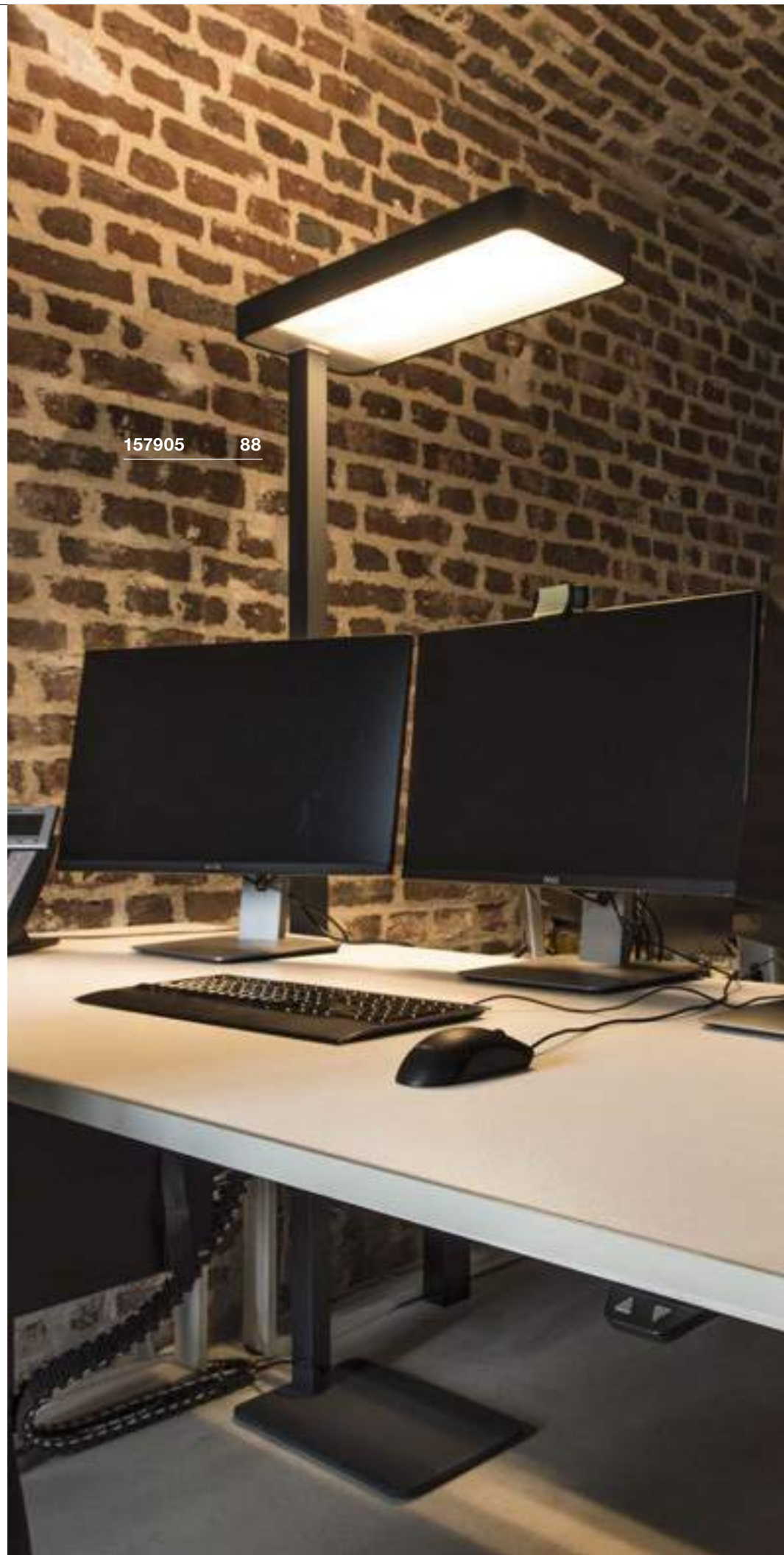

157905 88





1003523 89

WORKLIGHT PLUS  
FL

- Intelligent presence control and brightness sensor technology
- Suitable for screen-based workstations in line with EN 12464-1
- Direct and indirect light

## Product details

220-240V ~50/60Hz | 226mA  
 Total wattage: 48W  
 Material: aluminium/acrylic  
 Dimmable: switch

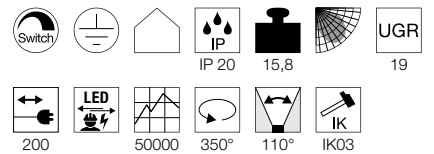

## Dimensional drawing

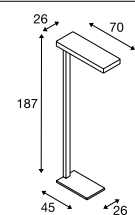

## Tip

Switch located on the light shaft  
 Safety plug

Variant	Item No.
Direct: 3600lm   3000K   CRI>80 Indirect: 1800lm   3000K   CRI>80	
□ matt white	1002847
Direct: 3600lm   3000K   CRI>80 Indirect: 1800lm   3000K   CRI>80	
■ matt anthracite	1002848
Direct: 3600lm   4000K   CRI>80 Indirect: 1800lm   4000K   CRI>80	
□ matt white	1003523
Direct: 3600lm   4000K   CRI>80 Indirect: 1800lm   4000K   CRI>80	
■ matt anthracite	1003524

# HANGING AROUND.

## PENDANTS CREATE EMPHASIS.

---

Give each room an individual feel: with pendants you immerse selected areas in atmospheric light and set visual highlights thanks to a wide range of style directions. Perfect for rest in restaurants, cafés, bars or at home – the luminaires create cosy locations and make a tasteful statement.

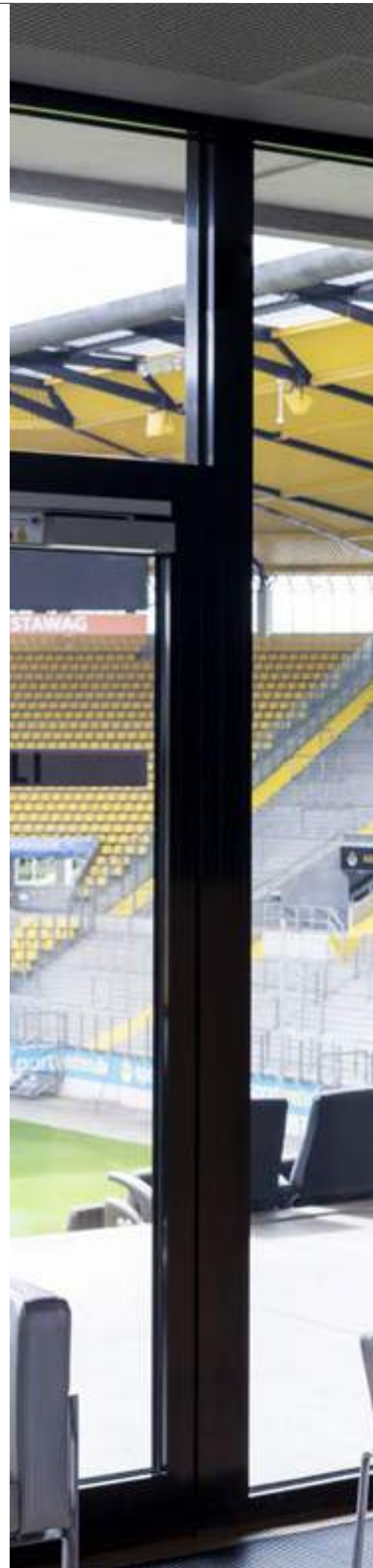



1004766    159

1002911 157



PENDANT LIGHTS

94	95	96	97	102	102	102	104
105	105	105	106	107	108	108	111
111	111	113	113	114	115	115	115
116	116	116	117	118	118	119	119
120	120	121	122	122	123	124	124

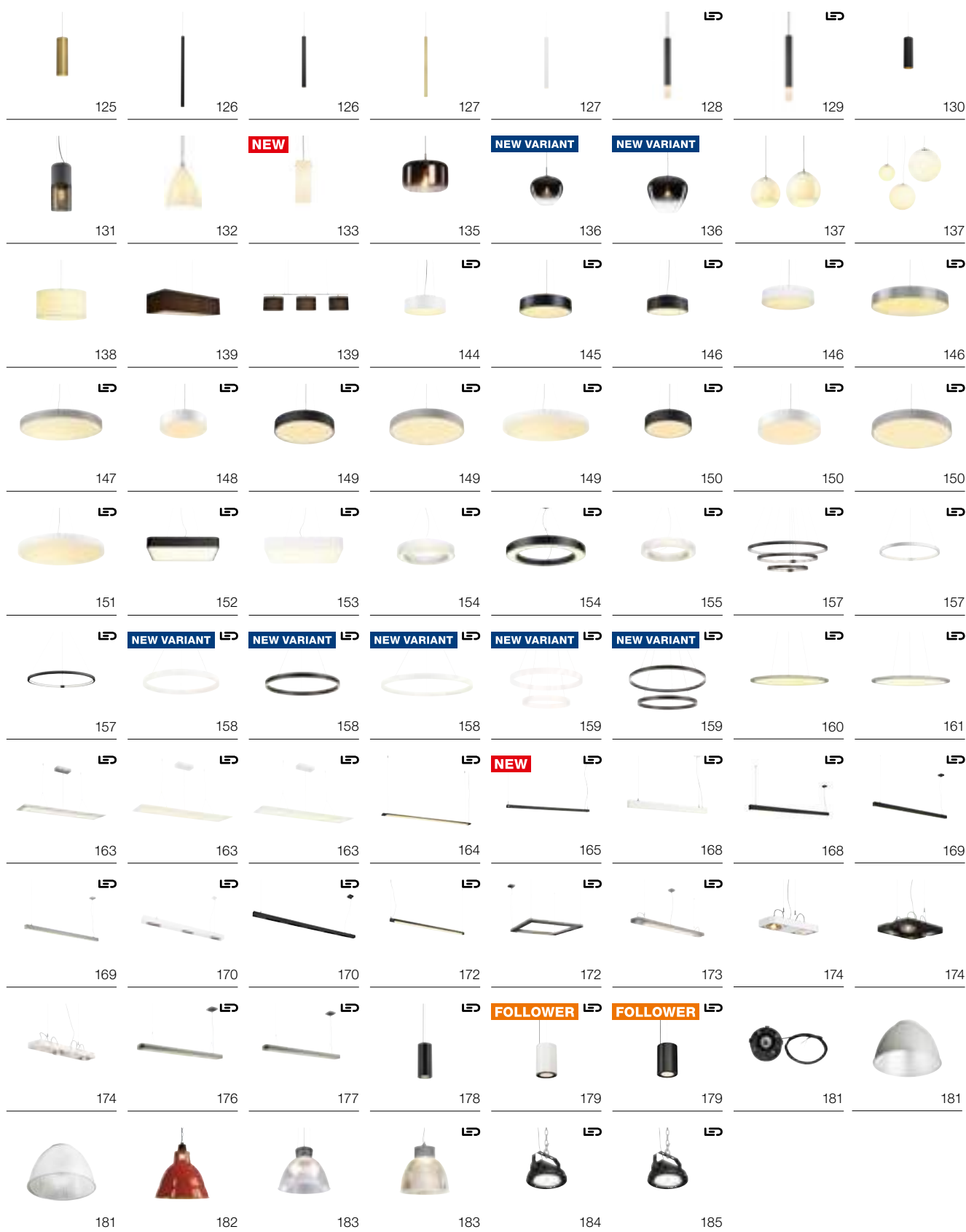

**i** Other luminaires and variants can be found online at [www.slv.com](http://www.slv.com)  
 You can find manufacturer's details for our recommended lamps in the chapter 'Lightbulbs', from page 844

FITU  
PD, E27SOCKET  
INSIDE

- 2.5 m-long cable
- Can be freely combined with Fitu ceiling rose and our accessories

## Product details

220-240V ~50/60Hz  
Material: aluminium



## Dimensional drawing

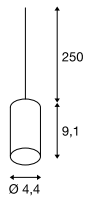

## Tip

Textile cable  
Open cable end

## Recommended lamp

LED E27 8W  
2000-2900K 300lm  
8kWh/1000h  
Item No. 1003096



LED E27 5W 330°  
2000K 500lm  
5kWh/1000h  
Item No. 560741



## Lamp details

max. 60W

Variant	Item No.
E27	
■ black	132650
E27	
□ white	132651
E27	
■ gold	1002167

132600 + 132650 98 + 94





132600 + 132690 98 + 95

FITU  
PD, E27SOCKET  
INSIDE

- 5 m-long cable
- Can be freely combined with Fitu ceiling rose and our accessories

## Product details

220-240V ~50/60Hz  
Material: aluminium

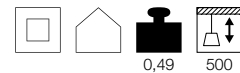

## Dimensional drawing

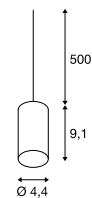

## Tip

Textile cable  
Open cable end

## Recommended lamp

LED E27 7W 280°  
2700K 790lm  
7kWh/1000h  
Item No. 1002127



LED E27 7W 280°  
2700K 790lm  
7kWh/1000h  
Item No. 1002124



## Lamp details

max. 60W

Variant	Item No.
E27	
■ black	132690
E27	
□ white	132691
E27	
■ gold	1002168

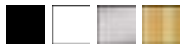
FITU  
PD, E27SOCKET  
INSIDE

- 2.5 m-long cable
- Can be freely combined with Fitu ceiling rose and our accessories
- Extra-long light body

## Product details

220-240V ~50/60Hz  
Material: aluminium



0,54 250

## Dimensional drawing

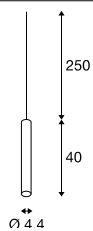

## Tip

Textile cable  
Open cable end  
Can be combined with Fitu Mix & Match accessories on page 98

## Recommended lamp

LED E27 4W 180°  
2000-2900K 200lm  
4kWh/1000h

Item No. 1003098



LED E27 5W 330°  
2000K 500lm  
5kWh/1000h

Item No. 560741



## Lamp details

max. 60W

Variant	Item No.
E27	
■ black	1002159
E27	
□ white	1002160
E27	
■ brushed aluminium	1002161
E27	
■ gold	1002162

1002162 96





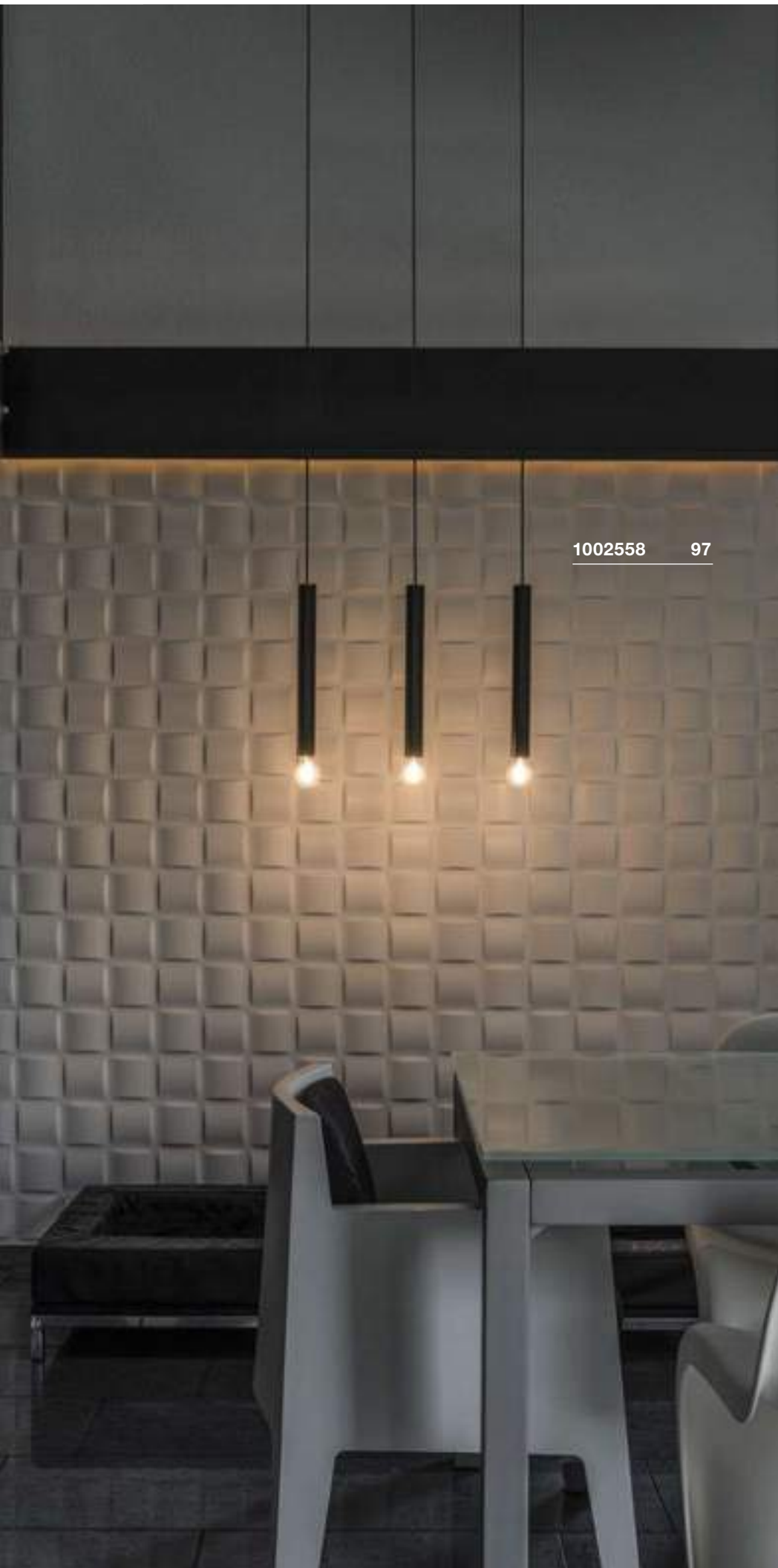

1002558 97

FITU  
PD, E27SOCKET  
INSIDE

- 5 m-long cable
- Can be freely combined with Fitu ceiling rose and our accessories

## Product details

220-240V ~50/60Hz  
Material: aluminium

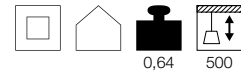

## Dimensional drawing

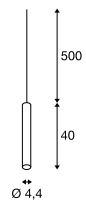

## Tip

Textile cable  
Open cable end  
Can be combined with Fitu Mix & Match accessories on page 98

## Recommended lamp

LED E27 5W 330°  
2000K 500lm  
5kWh/1000h  
Item No. 560741

LED E27 7W 280°  
2700K 790lm  
7kWh/1000h  
Item No. 1002124



## Lamp details

max. 60W

Variant	Item No.
E27	
■ black	1002558
E27	
□ white	1002562
E27	
■ brushed aluminium	1002563
E27	
■ gold	1002564

## FITU MIX &amp; MATCH ACCESSORIES

## Fitu single ceiling rose

16A max.  
Steel  
Diameter: 8.5cm H: 3.5cm  
inc. strain relief  
Weight: 0.14kg  
1 piece



Variant	Item No.
■ black	132600
□ white	132601
■ chrome	132605
■ gold	1002163

## Mounting rose with connection box

16A max.  
Steel/polyamide 66 (PA 66)  
Diameter: 8.5cm H: 3.3cm  
inc. strain relief  
Weight: 0.1kg  
1 piece



Variant	Item No.
■ matt black	1004674
□ matt white	1004675
■ chrome	1004676

## 1-phase light adapter

230V ~50Hz, 6A max.  
Plastic PC  
Max. Mechanical load 2 kg  
1 piece



Variant	Item No.
■ black	143120
□ white	143121
■ silver grey	143124

## Fitu triple ceiling rose

16A max.  
Steel  
Diameter: 22 cm H: 5.4 cm  
inc. strain relief  
Weight: 0.5 kg  
1 piece



Variant	Item No.
■ black	132610
□ white	132611
■ chrome	132615
■ gold	1002164

## Fitu triple ceiling rose

Steel  
Weight: 1.08 kg  
L: 60 cm W: 8.5 cm H: 5 cm  
inc. strain relief



Variant	Item No.
■ black	1001818
□ white	1001819
■ gold	1002264

## 3-circuit light adapter

230V ~50Hz, 10A max.  
Plastic  
Weight: 0.07 kg  
Max. Mechanical load 5 kg  
1 piece



Variant	Item No.
■ black	145990
□ white	1001542
■ silver grey	145994

## Fitu quintuple ceiling rose

16A max.  
Steel  
Diameter: 33 cm H: 6 cm  
inc. strain relief  
Weight: 1.25 kg  
1 piece



Variant	Item No.
■ black	132620
□ white	132621
■ chrome	132625
■ gold	1002165

## Fitu quintuple ceiling rose

16A max.  
Steel  
Weight: 2.06kg  
L: 120 cm W: 8.5 cm H: 5 cm  
inc. strain relief



Variant	Item No.
■ black	1001820
□ white	1001821
■ gold	1002265

## Cable clamp

16A max.  
Steel  
Weight: 0.01kg  
1 piece



Variant	Item No.
■ black	132680
□ white	132681

## Ceiling rose

16A max.  
Steel  
Diameter: 9 cm H: 2.6 cm  
inc. strain relief  
Weight: 0.15kg  
1 piece



Variant	Item No.
■ matt black	1004744
□ matt white	1004745
■ matt chrome	1004746

## Ceiling hook

Steel  
Weight: 0.04kg  
1 piece



Variant	Item No.
■ black	132670
□ white	132671

1002159 + 1001820 96 + 98





1002162 + 1002165 98 + 96



# SLV FENDA. MIX & MATCH.

MIX & match

MIX & MATCH Video

[bit.ly/slv-mix-match](https://bit.ly/slv-mix-match)



132662 + 156122 102 + 105



132660 + 1000580 102 + 105



132661 + 1000773 102

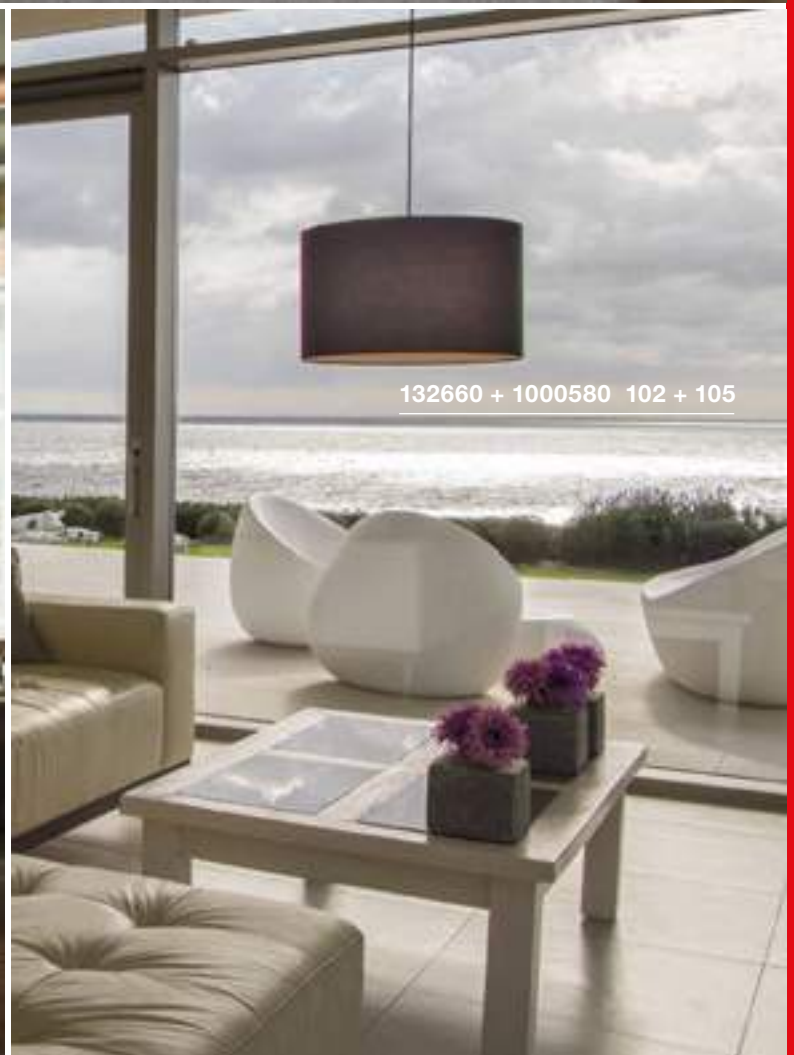

132660 + 1000580 102 + 105

FENDA  
PD, E27



SOCKET  
INSIDE



MIX & match



- Can be individually altered through the selection of lampshade

Product details

230V -50Hz  
Material: steel/plastic



Dimensional drawing

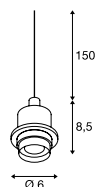

Tip

Open cable end  
Can be combined with Fitu Mix & Match accessories on page 98

Recommended lamp

LED E27 7W 280°  
2700K 790lm  
7kWh/1000h  
Item No. 1002124



LED E27 7W  
2700K 810lm  
7kWh/1000h  
Item No. 1003090



Lamp details

max. 60W

Variant	Item No.
E27	
■ black	132660
E27	
□ white	132661
E27	
■ chrome	132662

FENDA  
Glass shade



MIX & match



- Can be individually altered through the selection of light base

Product details

Material: glass



Dimensional drawing

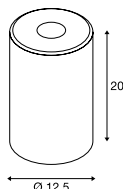

Tip

max. 40W  
Can be combined with Fitu Mix & Match accessories on page 98

FENDA  
diameter 40 cm, round



MIX & match



- Can be individually altered through the selection of light base

Product details

Material: Polymethylacrylate (PMMA)



Dimensional drawing

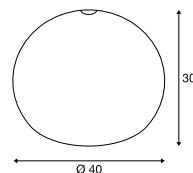

Tip

max. 60W

Variant	Item No.
□ glossy white	1000764



**FENDA**  
diameter 15 cm, round



MIX & match



- Can be individually altered through the selection of light base

**Product details**

Material: textile/steel



**Dimensional drawing**

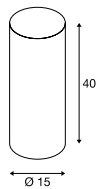

**Tip**

max. 40W



Variant	Item No.
white	156141
beige	156143
black/copper	156152

132605 + 156143 102 + 104

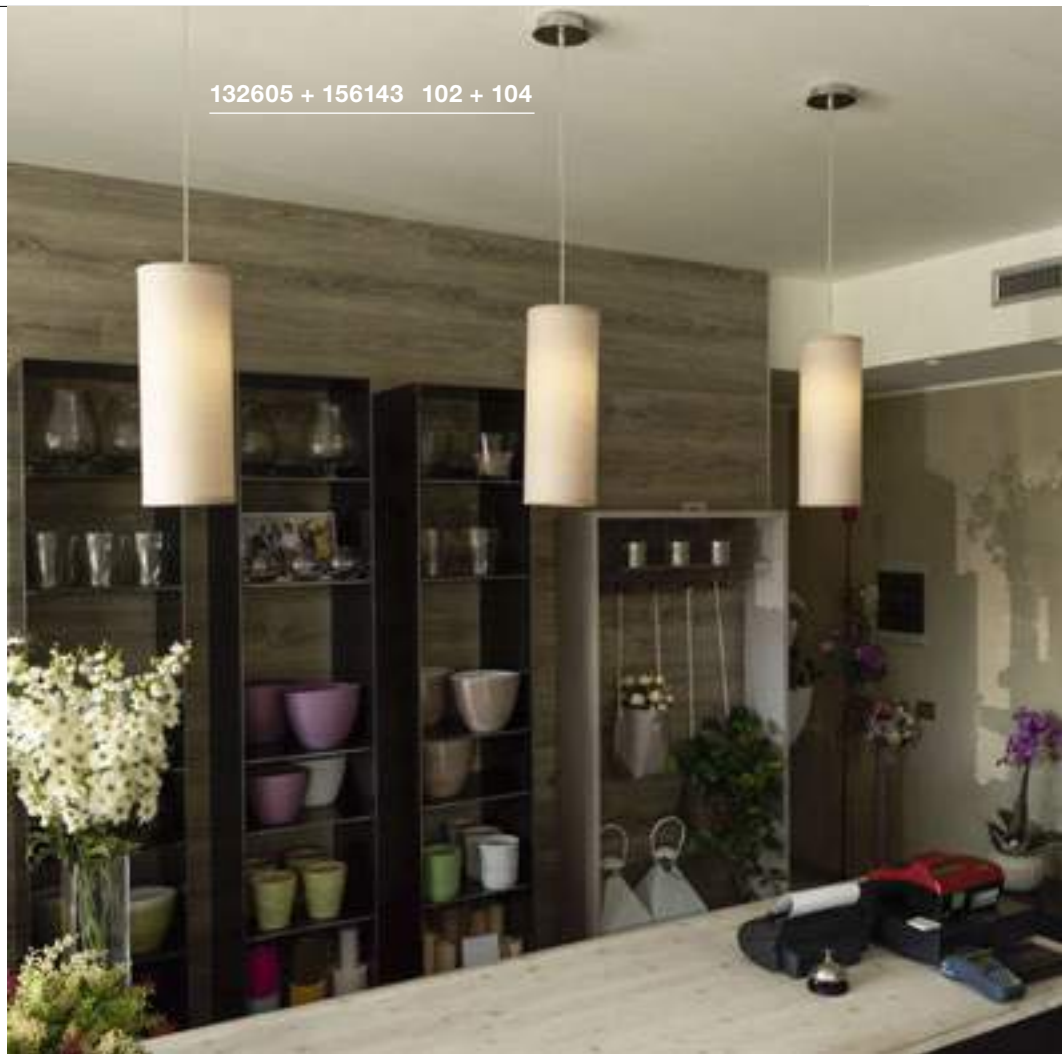

132660 + 1000580 102 + 105





FENDA  
diameter 30 cm, round



- Can be individually altered through the selection of light base

Product details

Material: textile/steel



Dimensional drawing

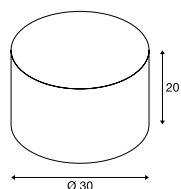

Tip

max. 60W  
Acrylic glass cover (155570) to close the shade on one side available as accessory.



Accessory recommendation

Acrylic glass cover  
Item No. 155570

Variant	Item No.
white	155582
beige	155583
black/copper	155592

FENDA  
diameter 45 cm, round



- Can be individually altered through the selection of light base

Product details

Material: textile/steel



Dimensional drawing

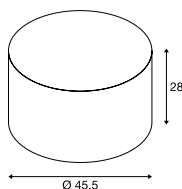

Tip

max. 60W  
Acrylic glass cover (156100) to close the shade on one side available as accessory.



Accessory recommendation

Acrylic glass cover  
Item No. 156100

Variant	Item No.
white	156111
beige	156113
black/copper	156122

FENDA  
diameter 70 cm, round



- Can be individually altered through the selection of light base

Product details

Material: textile/steel



Dimensional drawing

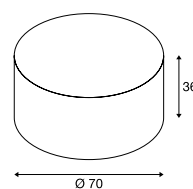

Tip

max. 60W  
Acrylic glass cover (1000957) to close the shade on one side available as accessory.



Accessory recommendation

Acrylic glass cover  
Item No. 1000957

Variant	Item No.
white	1000579
black/copper	1000580

## PLASTRA 25

PD, round, TCR-TSE



SOCKET  
INSIDE

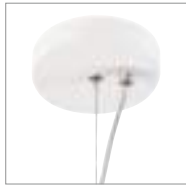

- Can be individually designed with colours, stickers & more

### Product details

230V -50Hz  
Material: gypsum/steel



2,2

150

### Dimensional drawing

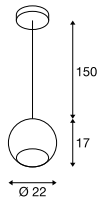

### Recommended lamp

LED GX53 8,2W 120°  
3000K 600lm  
9kWh/1000h  
Item No. 550073



LED GX53 8,2W 120°  
4000K 620lm  
9kWh/1000h  
Item No. 550074



### Lamp details

max. 11W TCR-TSE

Variant	Item No.
GX53   TCR-TSE	
<input type="checkbox"/> matt white	1002047

1002047 106





1004744 + 1004672 98 + 107



1004744 + 1004672 98 + 107

OCULUS  
PD, single, PHASE



Product details

220-240V ~50/60Hz | 250mA  
 Total wattage: 10.5W  
 Material: aluminium/glass  
 Dimmable: C



Dimensional drawing

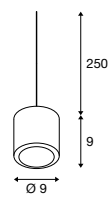

Tip

Open cable end

Variant	Item No.
36-780lm   2000-3000K   CRI>90	
■ matt black	1004672
36-780lm   2000-3000K   CRI>90	
□ matt white	1004673

LIGHT EYE® 90  
PD, GU10



SOCKET  
INSIDE



LIGHT EYE® 150  
PD, QPAR111



SOCKET  
INSIDE



• The optional decorative ring for the lightbulb in the matching colour reduces the distance between the housing and the lightbulb

Product details

220-240V ~50/60Hz  
Material: steel



Product details

220-240V ~50/60Hz  
Material: steel



Dimensional drawing

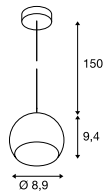

Dimensional drawing

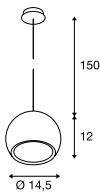

Tip

Textile cable

Tip

Textile cable

Accessory recommendation

■ Lamp decorative ring diameter 5.7cm  
Item No. 151040



□ Lamp decorative ring diameter 5.7cm  
Item No. 151041



■ Lamp decorative ring diameter 5.7cm  
Item No. 151049



Recommended lamp

LED GU10 4W 36°  
2700K 300lm  
4kWh/1000h  
Item No. 1004972



LED GU10 4W 36°  
3000K 300lm  
4kWh/1000h  
Item No. 1004973



Recommended lamp

LED GU10 13W 30°  
2700K 1100lm  
13kWh/1000h  
Item No. 1001242



LED GU10 6,5W 38°  
2700K 390lm  
7kWh/1000h  
Item No. 551882



Lamp details

max. 6W QPAR51

Variant	Item No.
GU10   QPAR51	
■ black/chrome	133490
GU10   QPAR51	
■ white/chrome	133491

Lamp details

max. 75W QPAR111

Variant	Item No.
GU10   QPAR111	
■ white/chrome	133481
GU10   QPAR111	
■ chrome	133482
GU10   QPAR111	
■ copper	133489

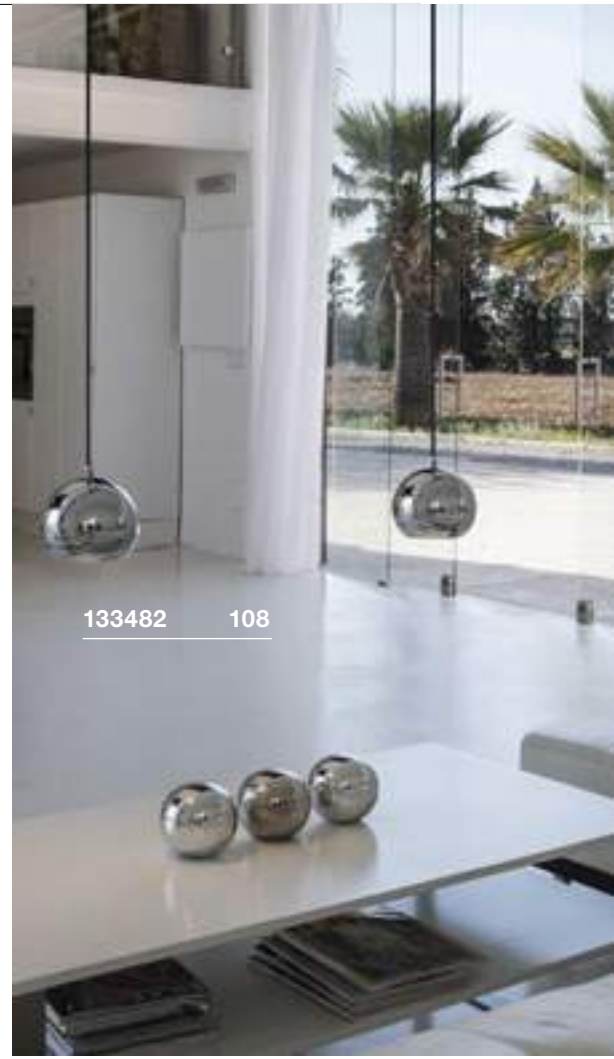

133482 108



133489 108



133481 108





1001943 111



1001941 111

VINCELLI D  
PD, PHASE



- Slim design
- Light body made of real bamboo

Product details

220-240V ~50/60Hz | 700mA  
Total wattage: 29W  
Material: bamboo/steel  
Dimmable: C, L

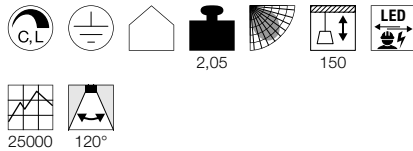

Dimensional drawing

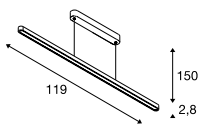

Variant	Item No.
1400lm   2700K   CRI>80 ■ anthracite / brown	156268 ▼

AROSA  
PD, 1,25m, PHASE



- Linear design
- Direct and indirect light

Product details

220-240V ~50/60Hz | 500mA  
Total wattage: 32W  
Material: aluminium/polymethylacrylate (PMMA)  
Dimmable: C

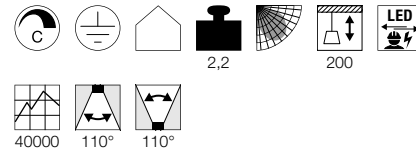

Dimensional drawing

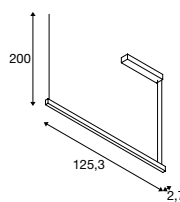

Variant	Item No.
Up: 750lm   3000K   CRI>80 Down: 950lm   3000K   CRI>80 ■ matt black	1001940
Up: 750lm   3000K   CRI>80 Down: 950lm   3000K   CRI>80 □ matt white	1001941
Up: 750lm   3000K   CRI>80 Down: 950lm   3000K   CRI>80 □ aluminium	1001942

AROSA  
PD, 2m, PHASE

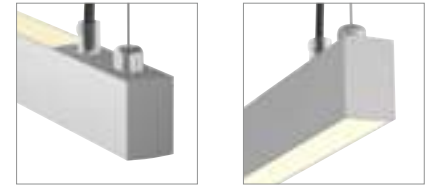
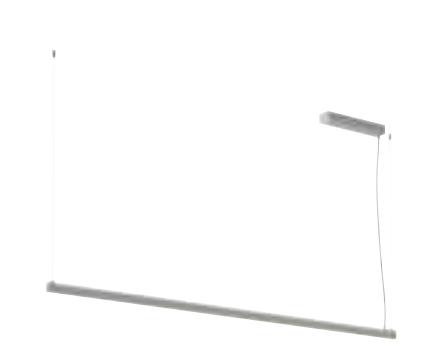

- Linear design
- Direct and indirect light

Product details

220-240V ~50/60Hz | 600mA  
Total wattage: 65W  
Material: aluminium/polymethylacrylate (PMMA)  
Dimmable: C

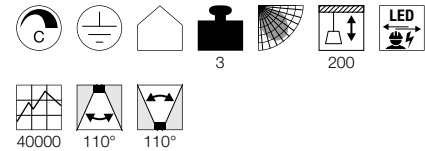

Dimensional drawing

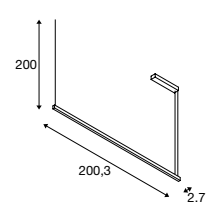

Variant	Item No.
Up: 1800lm   3000K   CRI>80 Down: 1800lm   3000K   CRI>80 ■ matt black	1001943
Up: 1800lm   3000K   CRI>80 Down: 1800lm   3000K   CRI>80 □ matt white	1001944
Up: 1800lm   3000K   CRI>80 Down: 1800lm   3000K   CRI>80 □ aluminium	1001945



155970 113



155970 113





155960 113



155960 113

### AVENTO 30 PD



- Textured and gold-coloured interior coating

#### Product details

220-240V ~50/60Hz | 350mA  
 Total wattage: 15W  
 Material: aluminium  
 Dimmable: C

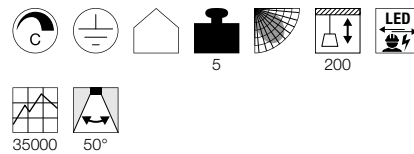

#### Dimensional drawing

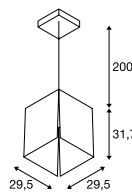

#### Tip

Textile cable

### AVENTO 110 PD



- Textured and gold-coloured interior coating

#### Product details

220-240V ~50/60Hz | 700mA  
 Total wattage: 29W  
 Material: aluminium  
 Dimmable: C

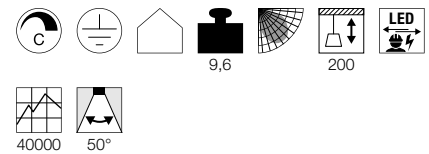

#### Dimensional drawing

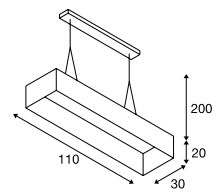

#### Tip

Textile cable

Variant	Item No.
660lm   3000K   CRI>80 ■ matt black/gold	155960

Variant	Item No.
250lm · 3000K · CRI>80 ■ matt black/gold	155970

**PHELIA 10**  
PD, E27



SOCKET  
INSIDE



- Individual light body shape
- Can be combined to form a cloud of lighting through individual composition

**Product details**

220-240V ~50/60Hz  
Material: aluminium



0,6

200

**Dimensional drawing**

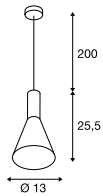

**Tip**

Textile cable

**Recommended lamp**

LED E27 7W  
2700K 640lm  
7kWh/1000h  
Item No. 1003085



LED E27 7W  
2700K 810lm  
7kWh/1000h  
Item No. 1003090



**Lamp details**

max. 23 W

Variant	Item No.
E27 ■ black/gold	1002951
E27 ■ black/gold	133330
E27 □ white	1002139

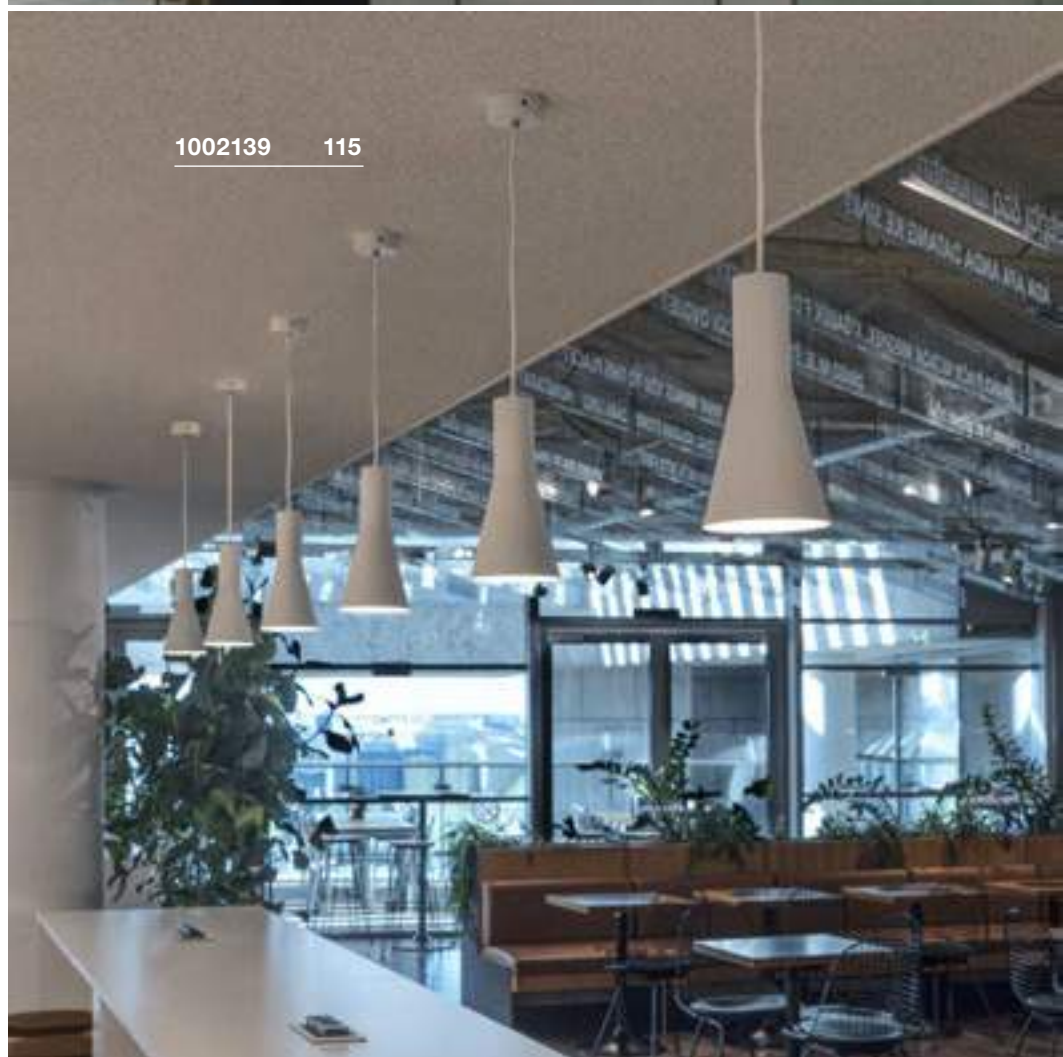

**PHELIA 20**  
PD, E27



SOCKET  
INSIDE



- Individual light body shape
- Can be combined to form a cloud of lighting through individual composition

**Product details**

220-240V ~50/60Hz  
Material: aluminium



**Dimensional drawing**

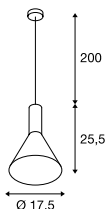

**Tip**

Textile cable

**Recommended lamp**

LED E27 14.5W 200°  
2700K 1521lm  
15kWh/1000h  
Item No. 560422



LED E27 7W  
2700K 810lm  
7kWh/1000h  
Item No. 1003090



**Lamp details**

max. 23 W

Variant	Item No.
E27 ■ black/gold	1002948
E27 ■ black/gold	133300
E27 □ white	1002136

**PHELIA 25**  
PD, E27



SOCKET  
INSIDE



- Individual light body shape
- Can be combined to form a cloud of lighting through individual composition

**Product details**

220-240V ~50/60Hz  
Material: aluminium



**Dimensional drawing**

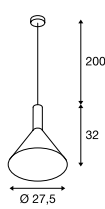

**Tip**

Textile cable

**Recommended lamp**

LED E27 4W 180°  
2000-2900K 200lm  
4kWh/1000h  
Item No. 1003098



LED E27 7W 280°  
2200-2700K 830lm  
7kWh/1000h  
Item No. 1002126



**Lamp details**

max. 23 W

Variant	Item No.
E27 ■ black/gold	1002949
E27 ■ black/gold	133310
E27 □ white	1002137

**PHELIA 30**  
PD, E27



SOCKET  
INSIDE



- Individual light body shape
- Can be combined to form a cloud of lighting through individual composition

**Product details**

220-240V ~50/60Hz  
Material: aluminium



**Dimensional drawing**

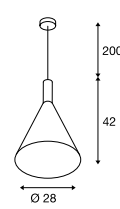

**Tip**

Textile cable

**Recommended lamp**

LED E27 5W 330°  
2000K 500lm  
5kWh/1000h  
Item No. 560741



LED E27 7.1W 330°  
2700K 806lm  
8kWh/1000h  
Item No. 1001756



**Lamp details**

max. 23 W

Variant	Item No.
E27 ■ black/gold	1002950
E27 ■ black/gold	133320
E27 □ white	1002138

BATO 35  
PD, PHASE



- Can be combined to form a cloud of lighting through individual composition

Product details

220-240V ~50/60Hz | 500mA  
Total wattage: 21W  
Material: aluminium/polymethylacrylate (PMMA)  
Dimmable: C

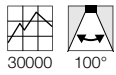

Dimensional drawing

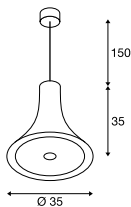

Tip

Textile cable

BATO 35  
PD, E27



- Can be combined to form a cloud of lighting through individual composition

Product details

220-240V ~50/60Hz  
Material: aluminium/steel

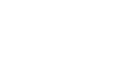

Dimensional drawing

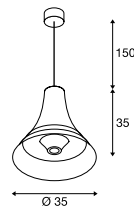

Tip

Textile cable

Recommended lamp

LED E27 4W 180°  
2000-2900K 200lm  
4kWh/1000h  
Item No. 1003098



LED E27 7W  
2700K 640lm  
7kWh/1000h  
Item No. 1003085



Lamp details

max. 60W

Variant	Item No.
1300lm   2700K   CRI>80 ■ matt black/ ■ matt brass	1001351
1300lm   2700K   CRI>80 ■ matt black	1000436
1500lm   2500K   CRI>80 ■ matt brass	1000441

Variant	Item No.
E27 ■ matt black/ ■ matt brass	1001266
E27 ■ matt black	1000434
E27 ■ matt brass	1000439

BATO 45  
PD, PHASE



- Can be combined to form a cloud of lighting through individual composition

Product details

220-240V ~50/60Hz | 700mA  
Total wattage: 30W  
Material: aluminium/polymethylacrylate (PMMA)  
Dimmable: C

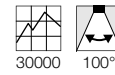
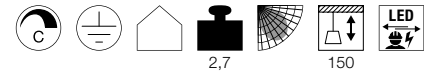

Dimensional drawing

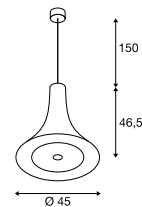

Tip

Textile cable

Variant	Item No.
1450lm   2700K   CRI>80 ■ matt black/ ■ matt brass	1001350
1450lm   2700K   CRI>80 ■ matt black	1000435
1900lm   2500K   CRI>80 ■ matt brass	1000440

BATO 45  
PD, E27



SOCKET  
INSIDE



- Can be combined to form a cloud of lighting through individual composition

Product details

220-240V ~50/60Hz  
Material: aluminium/steel



2.6

150

Dimensional drawing

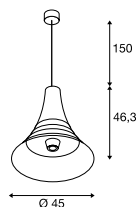

Tip

Textile cable

Recommended lamp

LED E27 8W  
2000-2900K 300lm  
8kWh/1000h  
Item No. 1003096



LED E27 8W 180°  
2000-2900K 400lm  
8kWh/1000h  
Item No. 1003099



Lamp details

max. 60W

Variant	Item No.
E27	
■ matt black/ ■ matt brass	1001265
E27	
■ matt black	1000433
E27	
■ matt brass	1000438

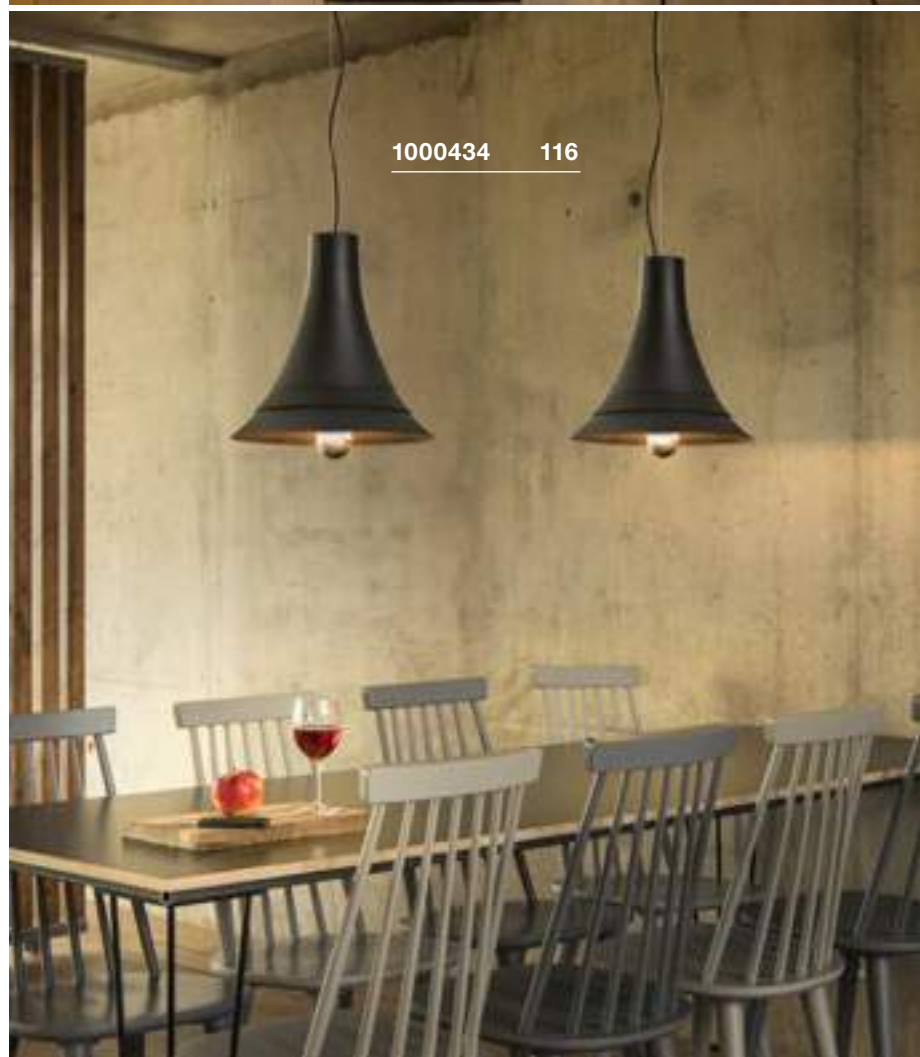

**FORCHINI 50**  
PD, E27



SOCKET  
INSIDE



- Every light is a unique one-off
- Textile cable in housing colour

**Product details**

230V -50Hz  
Material: GFK



2,6 150

**Dimensional drawing**

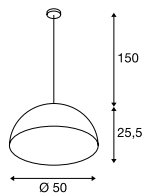

**Recommended lamp**

LED E27 7W 280°  
2200-2700K 830lm  
7kWh/1000h  
Item No. 1002126



LED E27 9.1W 240°  
2700K 760lm  
10kWh/1000h  
Item No. 560402



**Lamp details**

max. 40W  
L: 20 cm max.

Variant	Item No.
E27 black/silver	155520
E27 black/gold	155530
E27 white/gold	155531

**FORCHINI 70**  
PD, E27



SOCKET  
INSIDE

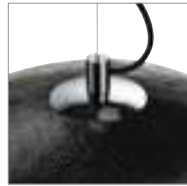

- Every light is a unique one-off
- Textile cable in housing colour

**Product details**

220-240V ~50/60Hz  
Material: GFK

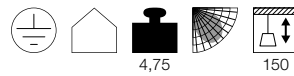

4,75 150

**Dimensional drawing**

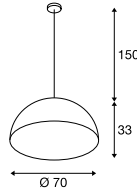

**Recommended lamp**

LED E27 8W 180°  
2000-2900K 400lm  
8kWh/1000h  
Item No. 1003099



LED E27 7W 330°  
2700K 806lm  
8kWh/1000h  
Item No. 1001038



**Lamp details**

max. 40W  
L: 20 cm max.

Variant	Item No.
E27 black/gold	1001701



155520 118



1001701 118



155910 119



155930 119

**FORCHINI M 40**  
PD, E27



**SOCKET**  
INSIDE



- Double-walled construction with interior reflector
- Textile cable in housing colour

**Product details**

230V -50Hz  
Material: aluminium/steel



**Dimensional drawing**

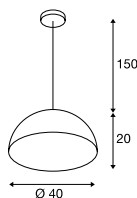

**Recommended lamp**

LED E27 4W 180°  
2000-2900K 200lm  
4kWh/1000h  
Item No. 1003098



LED E27 7W  
2700K 640lm  
7kWh/1000h  
Item No. 1003085



**Lamp details**

max. 40W  
L: 15.2 cm max.

Variant	Item No.
E27	
black/gold	155910
E27	
white/gold	155911

**FORCHINI M 50**  
PD, E27



**SOCKET**  
INSIDE



- Double-walled construction with interior reflector
- Textile cable in housing colour

**Product details**

230V -50Hz  
Material: aluminium/steel



**Dimensional drawing**

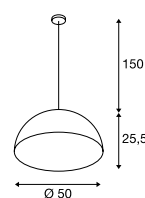

**Recommended lamp**

LED E27 8W 180°  
2000-2900K 400lm  
8kWh/1000h  
Item No. 1003099



LED E27 7W 180°  
2700K 630lm  
8kWh/1000h  
Item No. 1001357



**Lamp details**

max. 40W  
L: 18 cm max.

Variant	Item No.
E27	
black/gold	155930
E27	
white/gold	155931

PARA CONE 20  
PD, E27



SOCKET  
INSIDE



- Can be combined to form a cloud of lighting through individual composition
- Wide range of colours and sizes

Product details

220-240V ~50/60Hz  
Material: aluminium/steel



Dimensional drawing

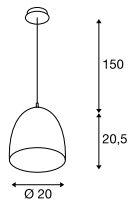

Tip

Textile cable  
black/gold version with golden reflector

Recommended lamp

LED E27 9.1W 240°  
2700K 760lm  
10kWh/1000h  
Item No. 560402



LED E27 7W 280°  
2200-2700K 830lm  
7kWh/1000h  
Item No. 1002126



Lamp details

max. 60W

Variant	Item No.
E27 glossy white	133001
E27 matt aluminium	133005
E27 matt copper	133009
E27 glossy black/gold	133050

PARA CONE 30  
PD, E27



SOCKET  
INSIDE



- Can be combined to form a cloud of lighting through individual composition
- Wide range of colours and sizes

Product details

220-240V ~50/60Hz  
Material: aluminium/steel

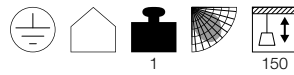

Dimensional drawing

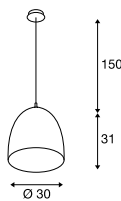

Tip

Textile cable  
black/gold version with golden reflector

Recommended lamp

LED E27 7W 280°  
2700K 790lm  
7kWh/1000h  
Item No. 1002127



LED E27 7W  
2700K 810lm  
7kWh/1000h  
Item No. 1003090



Lamp details

max. 60W

Variant	Item No.
E27 glossy white	133011
E27 matt aluminium	133015
E27 matt copper	133019
E27 glossy black/gold	133060







1002858 121



1002858 121

MALANG  
CW



- Can be integrated with the SLV VALETO® system and other ZigBee® systems
- Panel dimmable and can be controlled separately from warm to cold white
- Ring separately controllable in RGBW colours and dimmable

Product details

100-240V ~50/60Hz | 24V DC  
Systemleistung: 39W  
Material: aluminium/polycarbonate (PC)



30000

110°

Dimensional drawing

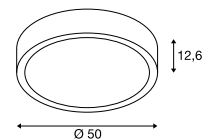

Tip

Remote-controllable and dimmable with SLV VALETO® CCT/RGBW remote control [1002994] or Gateway [1002411] Ring (RGBW) and panel (2700-6500K) are controlled separately. Zingbee 3.0

Accessory recommendation

- Suspension kit 1.5m  
Item No. 135250
- Suspension kit 1.5m  
Item No. 135251
- Suspension kit 1.5m  
Item No. 135254
- Suspension kit 5m  
Item No. 1001950
- Suspension kit 5m  
Item No. 1001951
- Suspension kit 5m  
Item No. 1001952
- CCT/RGBW remote control  
Item No. 1002994

Variant	Item No.
Ring: 350lm   RGB+W (3000K)   CRI>80	
Panel: 2100-2400lm   2700-6500K   CRI>80	
□ white	1002858

SPHERA 45  
PD, PHASE

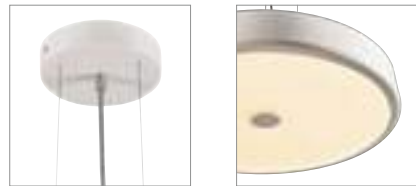

- Slim light body
- Surface features a high-gloss varnish

Product details

220-240V ~50/60Hz | 350mA  
Total wattage: 13W  
Material: aluminium/acrylic  
Dimmable: C

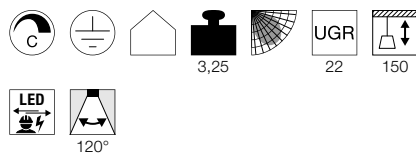

Dimensional drawing

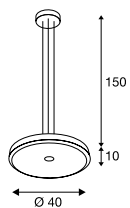

SPHERA 75  
PD, PHASE



- Slim light body
- Surface features a high-gloss varnish

Product details

220-240V ~50/60Hz | 500mA  
Total wattage: 15W  
Material: aluminium/acrylic  
Dimmable: C

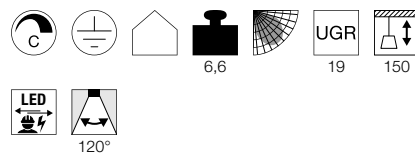

Dimensional drawing

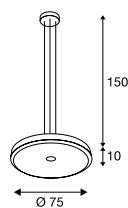

133341 122

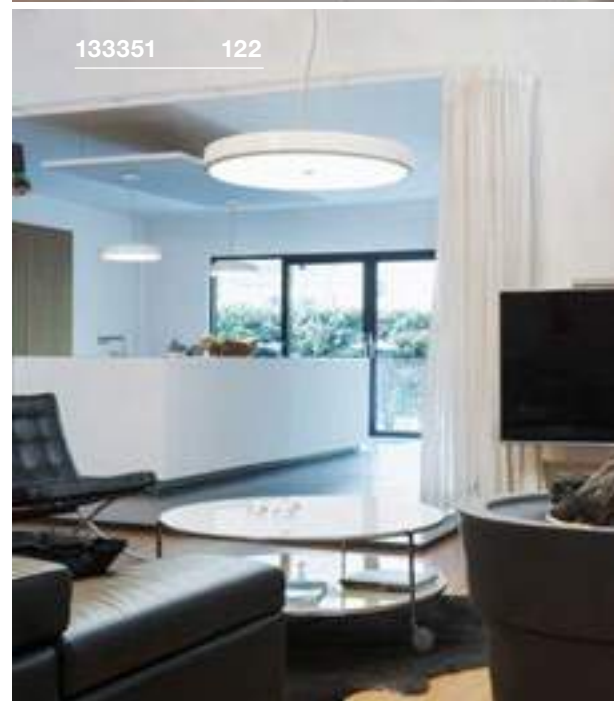

133351 122

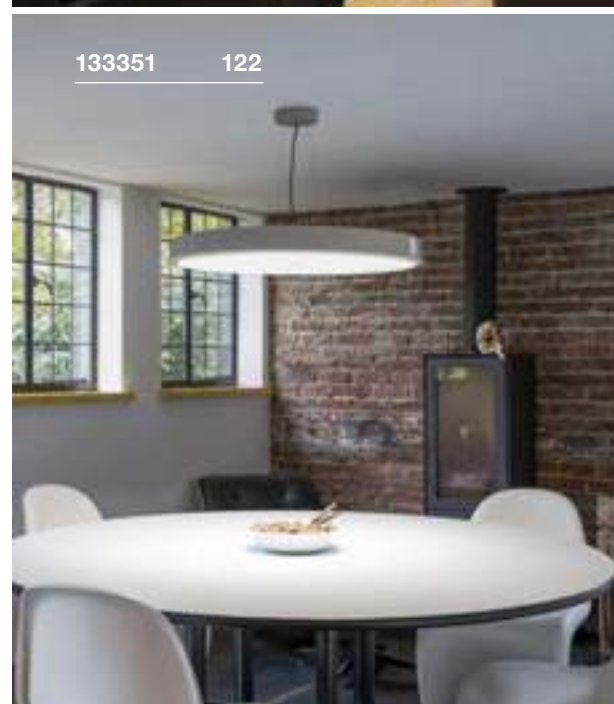

133351 122

Variant	Item No.
800lm   2700K   CRI>80 □ glossy white	133341

Variant	Item No.
1200lm   2700K   CRI>80 □ glossy white	133351



1002937 123

ASTINA  
PD, QPAR51SOCKET  
INSIDE

- High-quality, satin-finish glass
- 2.5 m-long cable

## Product details

220-240V ~50/60Hz  
Material: aluminium

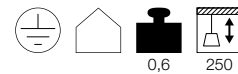

## Dimensional drawing

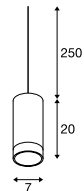

## Tip

Open cable end  
Can be combined with Fitu Mix & Match accessories on page 98

## Recommended lamp

LED GU10 6W 36°  
2700K 460lm  
6kWh/1000h  
Item No. 1005076



LED GU10 4W 36°  
2700K 300lm  
4kWh/1000h  
Item No. 1004972



## Lamp details

GU10 QPAR51 max. 10W

Variant	Item No.
GU10   QPAR51	
■ matt black	1002939
□ matt white	1002937
■ matt grey	1002938

PLASTRA  
PD, QPAR51



SOCKET  
INSIDE



ENOLA B  
PD, QPAR51



SOCKET  
INSIDE



• Can be individually modified

Product details

230V -50Hz  
Material: gypsum/steel

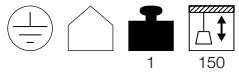

1 150

Dimensional drawing

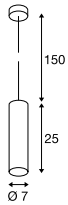

Recommended lamp

LED GU10 6W 36°  
2700K 460lm  
6kWh/1000h  
Item No. 1005076



LED GU10 4W 36°  
3000K 300lm  
4kWh/1000h  
Item No. 1004973



Lamp details

max. 7W QPAR51

Variant	Item No.
GU10   QPAR51 □ matt white	148042

Product details

220-240V ~50/60Hz  
Material: aluminium/steel



0,75 150

Dimensional drawing

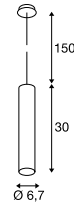

Recommended lamp

LED GU10 6W 36°  
4000K 460lm  
6kWh/1000h  
Item No. 1005083



LED GU10 4W 36°  
2700K 300lm  
4kWh/1000h  
Item No. 1004972



Lamp details

max. 50W QPAR51

Variant	Item No.
GU10   QPAR51 ■ black	151850
GU10   QPAR51 □ white	151851
GU10   QPAR51 ■ matt gold	151853
GU10   QPAR51 ■ silver grey	151854

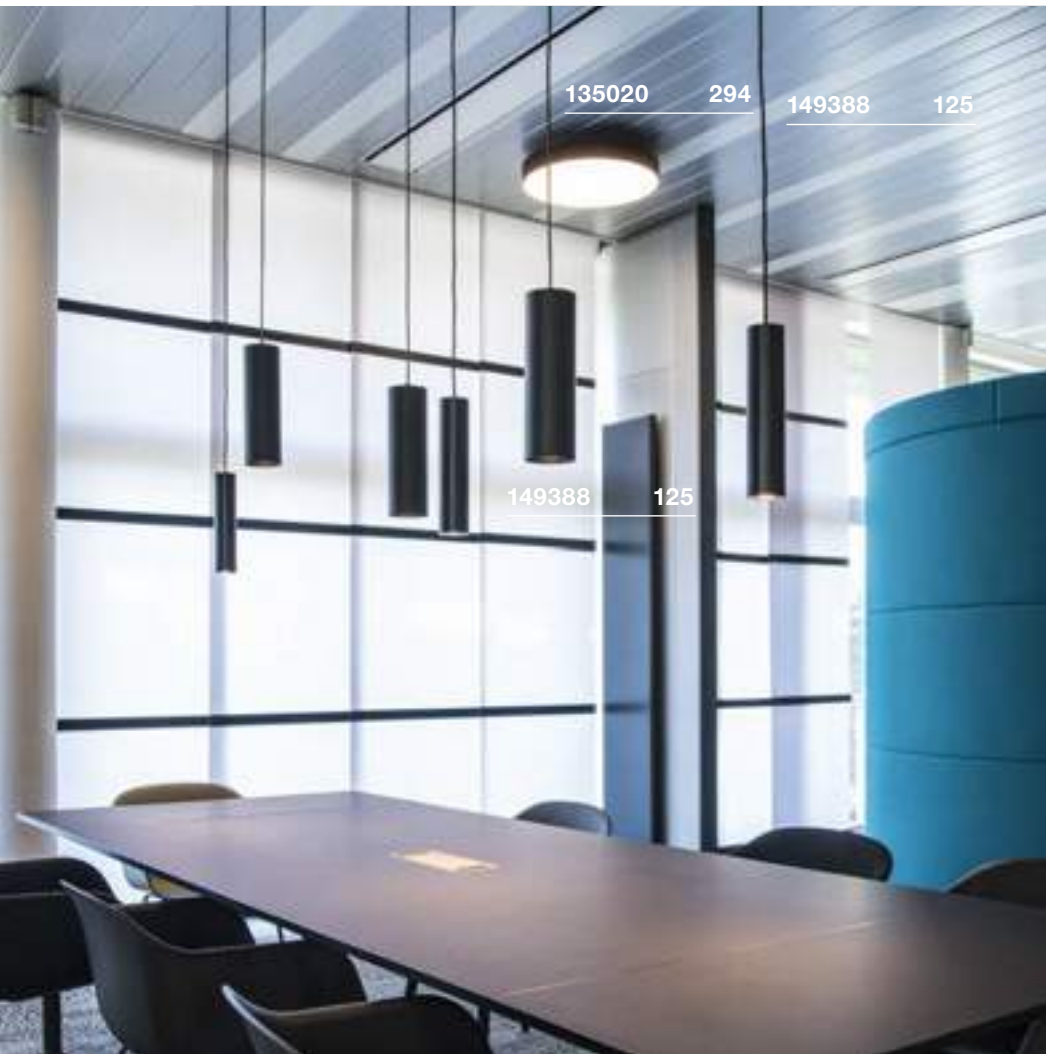
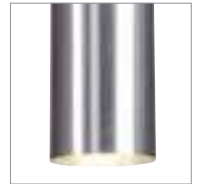

ENOLA  
PD, E27SOCKET  
INSIDE

## Product details

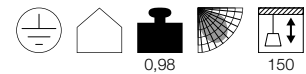
220-240V ~50/60Hz  
Material: aluminium/steel

## Dimensional drawing

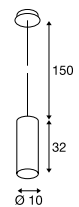

## Recommended lamp

LED E27 14.5W 200°  
2700K 1521lm  
15kWh/1000h  
Item No. 560422LED E27 7W  
2700K 810lm  
7kWh/1000h  
Item No. 1003090

## Lamp details

max. 60W  
Diameter: 9 cm max. L: 18 cm max.

Variant	Item No.
E27	
■ black	149388
E27	
□ white	149381
E27	
■ matt gold	149387
E27	
■ silver grey	149385



HELIA 30 PD



- Premium LED with CRI>90
- Slim, extra-long light body
- Rose for ceiling mounting

Product details

500mA  
 Total wattage: 7.5W  
 Material: aluminium  
 Installation dimensions:  
 Assembly-diameter: 6.8 cm T: 3 cm

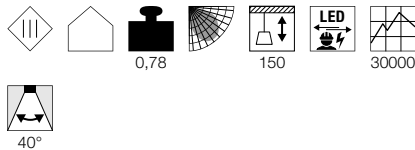

Dimensional drawing

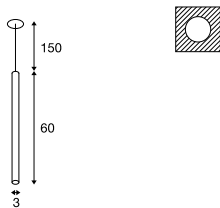

Tip

LED driver not included  
 Material thickness of mounting surface:  
 max. 12 mm

Accessory recommendation

- LED driver 500mA | 9W  
**Item No. 464091**
- LED Driver 500mA | 15W dimmable  
**Item No. 464144**

Variant	Item No.
500lm   3000K   CRI>90	
■ black	<b>158400</b>
550lm   3000K   CRI>90	
□ white	<b>158401</b>
550lm   3000K   CRI>90	
■ matt gold	<b>1002170</b>

HELIA 40 PD

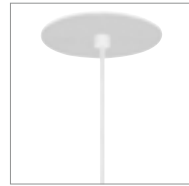

- Premium LED with CRI>90
- Long light body
- Rose for ceiling mounting

Product details

500mA  
 Total wattage: 9W  
 Material: aluminium  
 Installation dimensions:  
 Assembly-diameter: 6.8 cm T: 3 cm

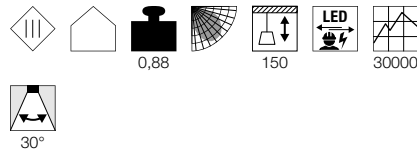

Dimensional drawing

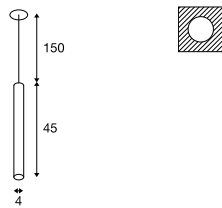

Tip

LED driver not included  
 Material thickness of mounting surface:  
 max. 12 mm

Accessory recommendation

- LED driver 500mA | 9W  
**Item No. 464091**
- LED Driver 500mA | 15W dimmable  
**Item No. 464144**

Variant	Item No.
700lm   3000K   CRI>90	
■ black	<b>158410</b>
720lm   3000K   CRI>90	
□ white	<b>158411</b>
720lm   3000K   CRI>90	
■ matt gold	<b>1002169</b>



152360 127



1002170 126



**HELIA 30**  
Ø: 3 cm | L: 60 cm

**HELIA 40**  
Ø: 4 cm | L: 45 cm

**HELIA 30**  
PD, PHASE



- Premium LED with CRI>90

**Product details**

220-240V ~50/60Hz | 500mA  
Total wattage: 10W  
Material: aluminium  
Dimmable: C, L

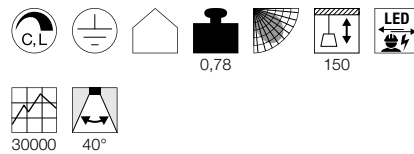

**Dimensional drawing**

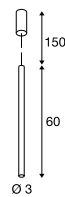

**HELIA 40**  
PD, PHASE



- Premium LED with CRI>90

**Product details**

220-240V ~50/60Hz | 500mA  
Total wattage: 12W  
Material: aluminium  
Dimmable: C, L

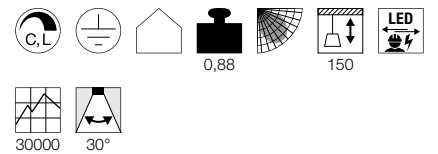

**Dimensional drawing**

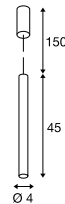

Variant	Item No.
500lm   3000K   CRI>90	
■ black	<b>152360</b>
550lm   3000K   CRI>90	
□ white	<b>152361</b>
550lm   3000K   CRI>90	
■ matt gold	<b>1002172</b>

Variant	Item No.
700lm   3000K   CRI>90	
■ black	<b>152370</b>
720lm   3000K   CRI>90	
□ white	<b>152371</b>
720lm   3000K   CRI>90	
■ matt gold	<b>1002171</b>

HELIA AMBIENT 35  
PD



NEW  
VARIANT

LED  
INSIDE

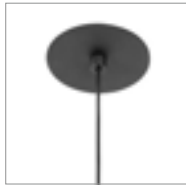

1003435 128

Product details

500mA  
Total wattage: 7.5W  
Material: aluminium/acrylic  
Installation dimensions:  
Assembly-diameter: 6.8 cm T: 3 cm



Dimensional drawing

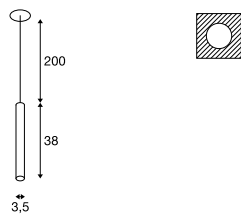

Tip

Recessed ceiling rose with open cable end.  
Driver not included  
Material thickness of mounting surface:  
max. 12 mm

Accessory recommendation

LED driver 500mA | 9W

Item No. 464091



LED Driver 500mA | 15W dimmable

Item No. 464144



Variant	Item No.
425lm   3000K   CRI>90	
■ matt black	1003435







1003436 129

HELIA AMBIENT 35  
PD, PHASENEW  
VARIANTLED  
INSIDE

## Product details

220-240V ~50/60Hz | 500mA  
 Total wattage: 9W  
 Material: aluminium/acrylic  
 Dimmable: C, L

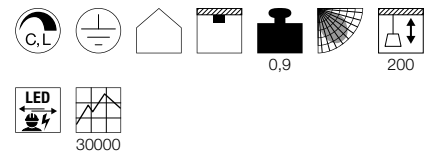

## Dimensional drawing

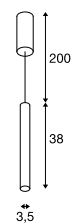

Variant	Item No.
425lm   3000K   CRI>90 ■ matt black	1003436

ANELA  
PD, PHASE



1000814 + 1000810 130

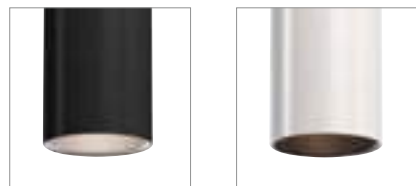
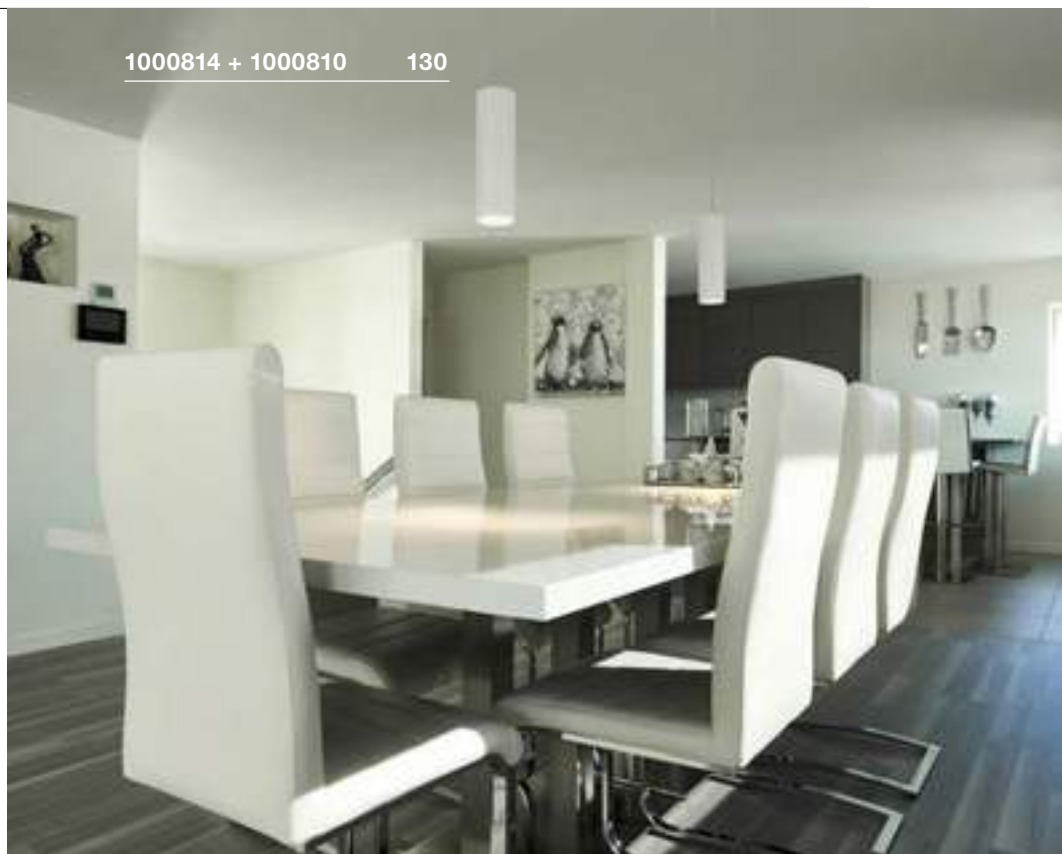

- Premium LED with CRI>90
- Glare reduction
- Colourful reflectors available as accessories

Product details

220-240V ~50/60Hz | 500mA  
Total wattage: 11W  
Material: aluminium  
Dimmable: C

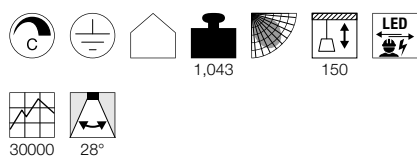

Dimensional drawing

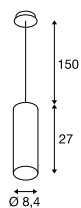

Tip

Reflector not included  
Luminous flux with reflector 1000809 = 500lm  
Luminous flux with reflector 1000810 = 620lm  
Luminous flux with reflector 1000811 = 200lm  
Luminous flux with reflector 1000812 = 620lm

Accessory recommendation

- Reflector 28°  
Item No. 1000809
- Reflector 28°  
Item No. 1000810
- Reflector 28°  
Item No. 1000811
- Reflector 28°  
Item No. 1000812

Variant	Item No.
200-620lm   3000K   CRI>90	
■ black	1000813
200-620lm   3000K   CRI>90	
□ white	1000814

1000813 + 1000810 130



Reflector 28° - replace the reflector of this light and enjoy a new lighting effect thanks to the different colours (gold, grey, black and white).



155714 131

LISENNE  
PD, E27
**SOCKET**  
**INSIDE**



- Basalt stone & smoked glass
- Height adjustable

**Product details**

 220-240V ~50/60Hz  
 Material: basalt/glass

2,8

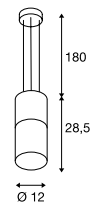
180

**Dimensional drawing**

**Recommended lamp**

 LED E27 7.1W 330°  
 2700K 806lm  
 8kWh/1000h  
**Item No. 1001756**

 LED E27 9W 240°  
 3000K 810lm  
 10kWh/1000h  
**Item No. 1001031**

**Lamp details**

 max. 23 W  
 Diameter: 5.9 cm max. L: 15 cm max.

Variant	Item No.
■ grey/mirrored brown	155714

TONGA®  
PD, E14



SOCKET  
INSIDE



Product details

220-240V ~50/60Hz  
Material: aluminium/glass



1

150

Dimensional drawing

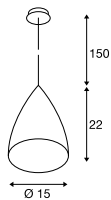

Recommended lamp

LED E14 4,5W 280°  
2700K 470lm  
5kWh/1000h  
Item No. 1002128



LED E14 6,5W 280°  
2700K 480lm  
7kWh/1000h  
Item No. 560372



Lamp details

max. 60W C35  
Diameter: 5cm max. L: 13cm max.

Variant	Item No.
E14   C35 white/silver	133444



133444

132



1003432 133

QUADRASS  
PD, E27

NEW

SOCKET  
INSIDE

## Product details

220-240V ~50/60Hz  
Material: steel/glass

IP 20



1,2



250

## Dimensional drawing

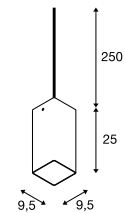

## Tip

Open cable end  
Can be combined with Fitu Mix & Match  
accessories on page 98

## Recommended lamp

LED E27 14.5W 200°  
2700K 1521lm  
15kWh/1000h  
Item No. 560422LED E27 9.1W 240°  
2700K 760lm  
10kWh/1000h  
Item No. 560402

## Lamp details

max. 40W  
Diameter: 6.5 cm max. L: 18 cm max.

Variant	Item No.
E27 white/chrome	1003432



1003006 135



1003007 135

**PANTILO 28**  
PD, E27**SOCKET**  
**INSIDE**

- High-quality chrome-plated glass shade
- Can be combined to form a cloud of lighting through individual composition

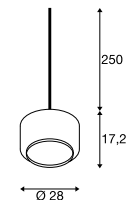
**Product details**200-240V ~50/60Hz  
Material: glass**Dimensional drawing****Tip**Open cable end  
Can be combined with Fitu Mix & Match accessories on page 98**Recommended lamp**LED E27 5W 330°  
2000K 500lm  
5kWh/1000h  
**Item No. 560741**LED E27 7W 330°  
2700K 806lm  
8kWh/1000h  
**Item No. 1001038****Lamp details**

max. 15W

Variant	Item No.
E27	
chrome	1003006
E27	
copper	1003007

PANTILO CONVEX 29  
PD, E27

NEW VARIANT

SOCKET INSIDE



- High-quality chrome-plated glass shade
- Can be combined to form a cloud of lighting through individual composition

Product details

220-240V ~50/60Hz  
Material: glass/steel



1,2 250

Dimensional drawing

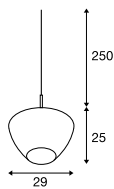

Tip

Open cable end  
Can be combined with Fitu Mix & Match accessories on page 98

Recommended lamp

LED E27 8W 350°  
2200K 250lm  
8kWh/1000h  
Item No. 1003100



LED E27 7W 280°  
2700K 790lm  
7kWh/1000h  
Item No. 1002124



Variant	Item No.
E27 chrome	1003443

PANTILO CONVEX 40  
PD, E27

NEW VARIANT

SOCKET INSIDE



- High-quality chrome-plated glass shade
- Can be combined to form a cloud of lighting through individual composition

Product details

220-240V ~50/60Hz  
Material: glass/steel

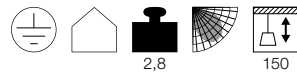

2,8 150

Dimensional drawing

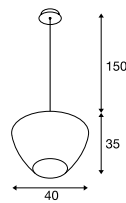

Recommended lamp

LED E27 7W 330°  
2700K 806lm  
8kWh/1000h  
Item No. 1001038



LED E27 7W 330°  
2700K 806lm  
8kWh/1000h  
Item No. 1001035



Variant	Item No.
E27 chrome	1003444



1003443 136



1003444 136





1002045 137

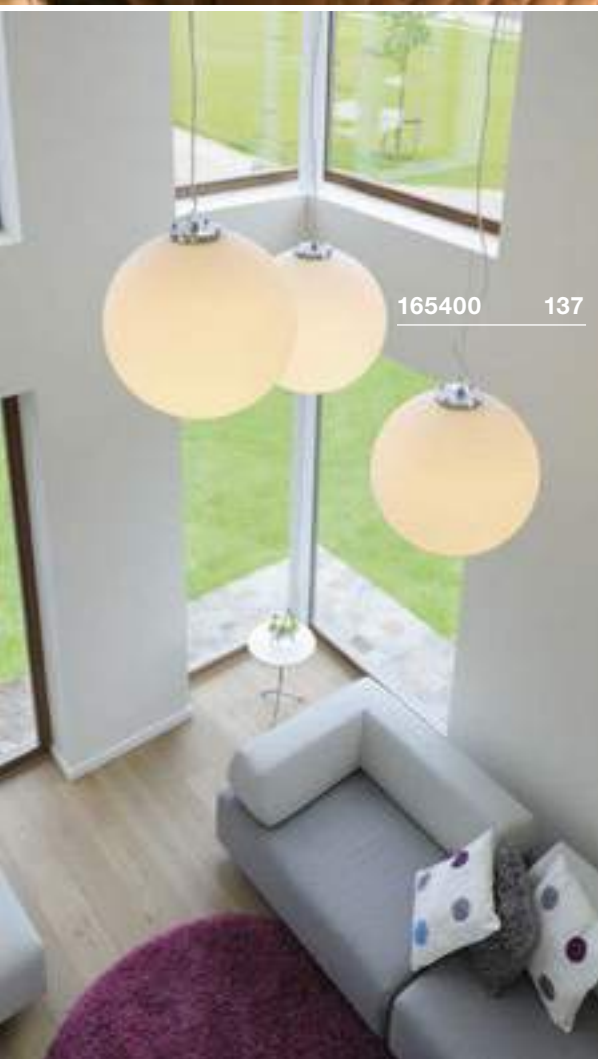

165400 137

SUN / BIG SUN  
PD, E27

SOCKET  
INSIDE

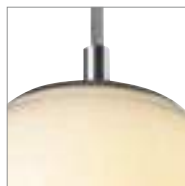

Product details

230V -50Hz  
Material: steel/glass

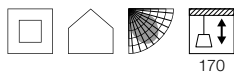

170

Dimensional drawing

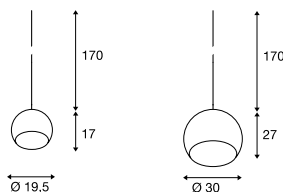

Tip

Open cable end  
Can be combined with Fitu Mix & Match accessories on page 98

Recommended lamp

LED E27 14.5W 200°  
2700K 1521lm  
15kWh/1000h  
Item No. 560422



LED E27 7W 280°  
2700K 790lm  
7kWh/1000h  
Item No. 1002124



Lamp details

max. 60W  
Diameter: 7 cm max. L: 17 cm max.

Variant	Item No.
E27   Diameter: 19.5 cm   0.73 kg	
white/chrome	1002045
E27   Diameter: 30 cm   1.83 kg	
white/chrome	1002046

ROTOBALL 25/40/50  
PD, E27

SOCKET  
INSIDE



• Height adjustable

Product details

230V -50Hz  
Material: steel/polyethylene (PE)

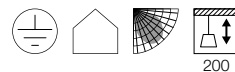

200

Dimensional drawing

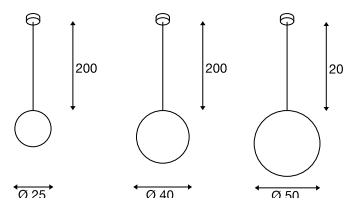

Recommended lamp

LED E27 14.5W 200°  
2700K 1521lm  
15kWh/1000h  
Item No. 560422



LED E27 7W  
2700K 810lm  
7kWh/1000h  
Item No. 1003090



Lamp details

max. 24W  
Diameter Item No. 165390 7 cm max.  
Diameter Item No. 165410 9,5 cm max.  
Diameter Item No. 165400 9.5 cm max.

Variant	Item No.
E27   Diameter: 25 cm   1.25 kg	
white/silver grey	165390
E27   Diameter: 40 cm   2.4 kg	
white/silver grey	165410
E27   Diameter: 50 cm   3.6 kg	
white/silver grey	165400

SOPRANA  
PD, E27SOCKET  
INSIDE

- Height adjustable
- Acrylic glass cover at the bottom of the shade

## Product details

230V -50Hz  
Material: textile/acrylic



## Dimensional drawing

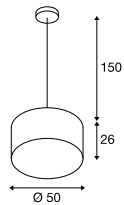

## Recommended lamp

LED E27 9.1W 240°  
2700K 760lm  
10kWh/1000h  
Item No. 560402



LED E27 7W  
2700K 810lm  
7kWh/1000h  
Item No. 1003090



## Lamp details

3x max. 60W  
L: 16.5 cm max.

Variant	Item No.
E27	
white	155462
E27	
beige	155463

155462 138





1002947 139

**ACCANTO**  
PD, E27



SOCKET  
INSIDE



- Acrylic cover at the bottom of the shade
- Height adjustable

**Product details**

220-240V ~50/60Hz  
Material: steel/textile  
Product dimensions: L: 80 cm W: 30 cm H: 20 cm



**Dimensional drawing**

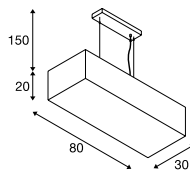

155871 139

**TRIADEM**  
PD, E27

SOCKET  
INSIDE

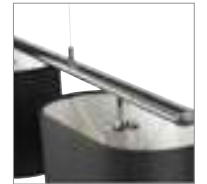

- Height adjustable

**Product details**

230V -50Hz  
Material: textile/steel

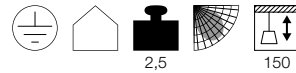

**Dimensional drawing**

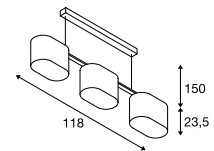

**Recommended lamp**

LED E27 9.1W 240°  
2700K 760lm  
10kWh/1000h  
Item No. 560402



LED E27 7W 280°  
2700K 790lm  
7kWh/1000h  
Item No. 1002124



**Lamp details**

3x max. 40W  
L: 13cm max.

Variant	Item No.
E27	
■ black/chrome	1002946
E27	
■ white/chrome	1002947

**Recommended lamp**

LED E27 14.5W 200°  
2700K 1521lm  
15kWh/1000h  
Item No. 560422



LED E27 7W 280°  
2700K 790lm  
7kWh/1000h  
Item No. 1002127



**Lamp details**



3x max. 60W  
L: 14 cm max.

Variant	Item No.
E27	
■ black/chrome	155870
E27	
■ white/chrome	155871







# MEDO LIGHTING SERIES.

## PENDANT AND CEILING LIGHTS.

	MEDO 30 CL, 1-10V	MEDO 40 CL, 1-10V	MEDO 60 CL, 1-10V	MEDO 90 CL, 1-10V
Example				
Lightbulb				
Size	Diameter: 30cm	Diameter: 40cm	Diameter: 60cm	Diameter: 90cm
Light strength	1000lm	2000lm	3500lm	11000lm
UGR	25	25	22	25
Dimmable	1-10V	1-10V	1-10V	1-10V
Suspension set (not included)	1.5 m   5 m	1.5 m   5 m	1.5 m   5 m	1.5 m   5 m

	MEDO 30 CL, PHASE	MEDO 40 CL, PHASE	
Example			
Lightbulb			
Size-diameter	Diameter: 30cm	Diameter: 40cm	
Light strength	1200lm	2125lm	
UGR	25	25	
Dimmable	C, L	C, L	
Suspension set (not included)	1.5 m   5 m	1.5 m   5 m	















	MEDO 60 CL, square, 1-10V	MEDO 60 CL, square, DALI	
Example			
Lightbulb			
Size	W   L: 60cm	W   L: 60cm	
Light strength	3300 lm	3300 lm	
UGR	22	22	
Dimmable	1-10V		
Suspension set (not included)	1.5 m   5 m	1.5 m   5 m	

	MEDO RING 60 PD, 1-10V	MEDO RING 90 PD, 1-10V	MEDO RING 60 PD, DALI
Example			
Lightbulb			
Size	Diameter: 60cm	Diameter: 90cm	Diameter: 60cm
Light strength	2000lm	3945lm	2000lm
UGR	-	-	22
Dimmable	1-10V	1-10V	
Suspension kit	not necessary, (inc.) - pure pendant light	not necessary, (inc.) - pure pendant light	not necessary, (inc.) - pure pendant light

# MEDO LIGHTING SERIES.

## PENDANT AND CEILING LIGHTS.

	MEDO 30 AMBIENT CW, PHASE	MEDO 40 AMBIENT CW, PHASE	MEDO 60 AMBIENT CW, PHASE	MEDO 90 AMBIENT CL, PHASE
Example				
Lightbulb				
Size	Diameter: 30cm	Diameter: 40cm	Diameter: 60cm	Diameter: 90cm
Light strength	Down: 1230/1280lm Up: 20lm	Down: 2750/2900lm Up: 50lm	Down: 4350/4750lm Up: 120lm	Down: 9500/10100lm Up: 125lm
UGR	25	25	25	25
Dimmable	C	C	C	C
Suspension set (not included)	1.5 m   5 m	1.5 m   5 m	1.5 m   5 m	1.5 m   5 m

	MEDO 30 AMBIENT CW, DALI	MEDO 40 AMBIENT CW, DALI	MEDO 60 AMBIENT CW, DALI	MEDO 90 AMBIENT CL, DALI
Example				
Lightbulb				
Size	Diameter: 30cm	Diameter: 40cm	Diameter: 60cm	Diameter: 90cm
Light strength	Down: 1230/1280lm Up: 20lm	Down: 2750/2900lm Up: 50lm	Down: 4350/4750lm Up: 120lm	Down: 9500/10100lm Up: 125lm
UGR	25	25	25	25
Dimmable				
Suspension set (not included)	1.5 m   5 m	1.5 m   5 m	1.5 m   5 m	1.5 m   5 m



**Ambient effect** – These MEDO variants produce even and indirect light in an upwards direction.



**Colour temperature** – With this MEDO variant, you can select the colour temperature yourself. The switch on the reverse can be used to choose between 3000k and 4000k.



MEDO 30  
CL, PHASE



• Can be converted to a pendant light using accessories that are separately available

Product details

220-240V ~50/60Hz | 350mA  
Total wattage: 16W  
Material: aluminium/polymethylacrylate (PMMA)  
Dimmable: C, L

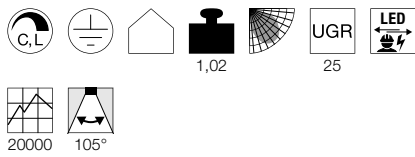

Dimensional drawing

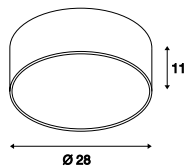

Tip

Suspension set not included

Accessory recommendation

- Suspension kit 1.5m  
Item No. 135250
- Suspension kit 1.5m  
Item No. 135251
- Suspension kit 1.5m  
Item No. 135254
- Suspension kit 5m  
Item No. 1001950
- Suspension kit 5m  
Item No. 1001951
- Suspension kit 5m  
Item No. 1001952

Variant	Item No.
1200lm   3000K   CRI>80 ■ black	135020
1200lm   3000K   CRI>80 □ white	135021
1200lm   3000K   CRI>80 ■ grey	135024



135250 146

135120 146

135020 138





135074 145

MEDO 40  
CL, PHASE



- Can be converted to a pendant light using accessories that are separately available

Product details

220-240V ~50/60Hz | 700mA  
 Total wattage: 31W  
 Material: aluminium/polymethylacrylate (PMMA)  
 Dimmable: C, L

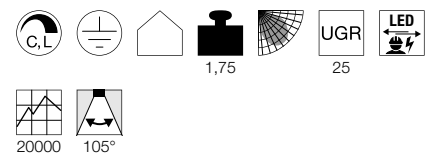

Dimensional drawing

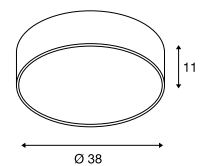

Tip

Suspension set not included

Accessory recommendation

- Suspension kit 1.5m  
Item No. 135250
- Suspension kit 1.5m  
Item No. 135251
- Suspension kit 1.5m  
Item No. 135254
- Suspension kit 5m  
Item No. 1001950
- Suspension kit 5m  
Item No. 1001951
- Suspension kit 5m  
Item No. 1001952

Variant	Item No.
2125lm   3000K   CRI>80	
■ black	135070
2125lm   3000K   CRI>80	
□ white	135071
2125lm   3000K   CRI>80	
■ grey	135074

MEDO 30  
CL, 1-10V



• Can be converted to a pendant light using accessories that are separately available

Product details

220-240V ~50/60Hz | 350mA  
Total wattage: 15W  
Material: aluminium/polymethylacrylate (PMMA)  
Dimmable: 1-10V

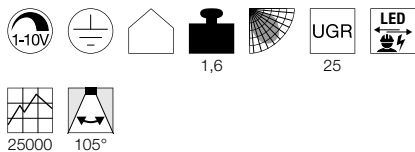

Dimensional drawing

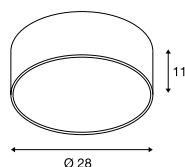

Tip

Suspension set not included

Accessory recommendation

- Suspension kit 1.5m  
Item No. 135250
- Suspension kit 1.5m  
Item No. 135251
- Suspension kit 1.5m  
Item No. 135254
- 1-10V dimming  
Item No. 470505
- Suspension kit 5m  
Item No. 1001950
- Suspension kit 5m  
Item No. 1001951
- Suspension kit 5m  
Item No. 1001952

Variant	Item No.
1000lm   3000K   CRI>80	
■ black	1000855
1000lm   3000K   CRI>80	
□ white	1000856
1000lm   3000K   CRI>80	
■ grey	1000857

MEDO 40  
CL, 1-10V



• Can be converted to a pendant light using accessories that are separately available

Product details

120-240V ~50/60Hz | 700mA  
Total wattage: 29W  
Material: aluminium/polymethylacrylate (PMMA)  
Dimmable: 1-10V

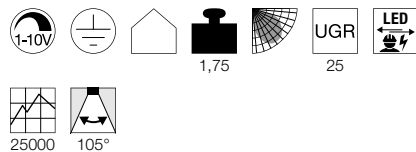

Dimensional drawing

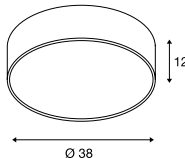

Tip

Suspension set not included

Accessory recommendation

- Suspension kit 1.5m  
Item No. 135250
- Suspension kit 1.5m  
Item No. 135251
- Suspension kit 1.5m  
Item No. 135254
- 1-10V dimming  
Item No. 470505
- Suspension kit 5m  
Item No. 1001950
- Suspension kit 5m  
Item No. 1001951
- Suspension kit 5m  
Item No. 1001952

Variant	Item No.
2000lm   3000K   CRI>80	
■ black	1000864
2000lm   3000K   CRI>80	
□ white	1000865
2000lm   3000K   CRI>80	
■ grey	1000866

MEDO 60  
CL, 1-10V

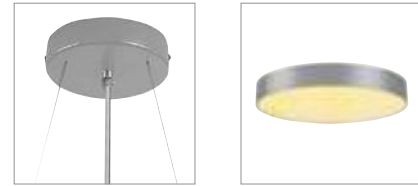

• Can be converted to a pendant light using accessories that are separately available

Product details

100-240V ~50/60Hz | 1000mA  
Total wattage: 40W  
Material: aluminium/polymethylacrylate (PMMA)  
Dimmable: 1-10V

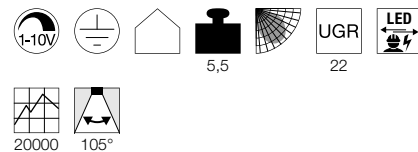

Dimensional drawing

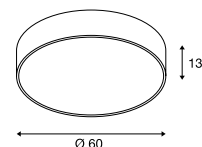

Tip

Suspension set not included

Accessory recommendation

- Suspension kit 1.5m  
Item No. 135250
- Suspension kit 1.5m  
Item No. 135251
- Suspension kit 1.5m  
Item No. 135254
- 1-10V dimming  
Item No. 470505
- Suspension kit 5m  
Item No. 1001950
- Suspension kit 5m  
Item No. 1001951
- Suspension kit 5m  
Item No. 1001952

Variant	Item No.
3500lm   3000K   CRI>80	
■ black	135120
3500lm   3000K   CRI>80	
□ white	135121
3500lm   3000K   CRI>80	
■ grey	135124



135121 146

MEDO 90  
CL, 1-10V



- Can be converted to a pendant light using accessories that are separately available

**Product details**

220-240V ~50/60Hz | 2900mA  
 Total wattage: 119W  
 Material: aluminium/polymethylacrylate (PMMA)  
 Dimmable: 1-10V

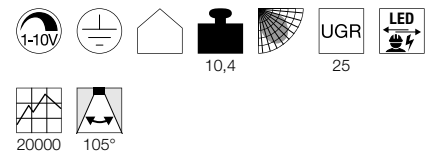

**Dimensional drawing**

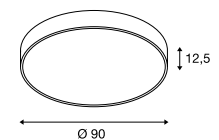

**Tip**

Suspension set not included

**Accessory recommendation**

- Suspension kit 1.5m  
Item No. 135250
- Suspension kit 1.5m  
Item No. 135251
- Suspension kit 1.5m  
Item No. 135254
- 1-10V dimming  
Item No. 470505
- Suspension kit 5m  
Item No. 1001950
- Suspension kit 5m  
Item No. 1001951
- Suspension kit 5m  
Item No. 1001952

Variant	Item No.
11000lm   3000K   CRI>80	
■ black	135170
11000lm   3000K   CRI>80	
□ white	135171
11000lm   3000K   CRI>80	
■ grey	135174

MEDO 30 AMBIENT  
CW, PHASE

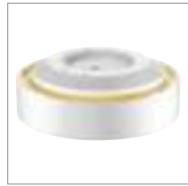

- With ambient effect
- Colour temperature (3000K/4000K) can be adjusted using the switch
- Can be converted to a pendant light using accessories that are separately available

Product details

220-240V ~50/60Hz | 350mA  
 Total wattage: 15W  
 Material: aluminium/polycarbonate (PC)  
 Dimmable: C

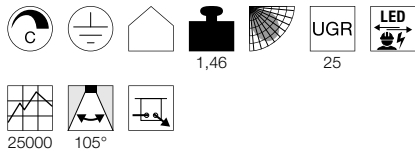

Dimensional drawing

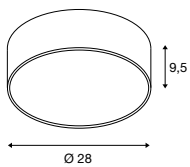

Tip

Suspension set not included

Accessory recommendation

- Suspension kit 1.5m  
Item No. **135250**
- Suspension kit 1.5m  
Item No. **135251**
- Suspension kit 1.5m  
Item No. **135254**
- Suspension kit 5m  
Item No. **1001950**
- Suspension kit 5m  
Item No. **1001951**
- Suspension kit 5m  
Item No. **1001952**

Variant	Item No.
Down: 1230/1280lm   3000/4000K   CRI>80 Up: 20lm   3000/4000K   CRI>80	
<input checked="" type="checkbox"/> black	<b>1001877</b>
Down: 1230/1280lm   3000/4000K   CRI>80 Up: 20lm   3000/4000K   CRI>80	
<input type="checkbox"/> white	<b>1001881</b>
Down: 1230/1280lm   3000/4000K   CRI>80 Up: 20lm   3000/4000K   CRI>80	
<input checked="" type="checkbox"/> grey	<b>1001882</b>



135250 149

1001878 149

MEDO 40 AMBIENT  
CW, PHASE



- With ambient effect
- Colour temperature (3000K/4000K) can be adjusted using the switch
- Can be converted to a pendant light using accessories that are separately available

Product details

220-240V ~50/60Hz | 700mA  
Total wattage: 30W  
Material: aluminium/polycarbonate (PC)  
Dimmable: C

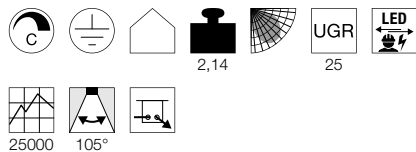

Dimensional drawing

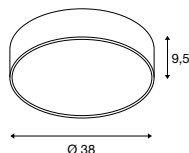

Tip

Suspension set not included

Accessory recommendation

- Suspension kit 1.5m  
Item No. 135250
- Suspension kit 1.5m  
Item No. 135251
- Suspension kit 1.5m  
Item No. 135254
- Suspension kit 5m  
Item No. 1001950
- Suspension kit 5m  
Item No. 1001951
- Suspension kit 5m  
Item No. 1001952

Variant	Item No.
Down: 2750/2900lm   3000/4000K   CRI>80 Up: 50lm   3000/4000K   CRI>80	
■ black	1001883
Down: 2750/2900lm   3000/4000K   CRI>80 Up: 50lm   3000/4000K   CRI>80	
□ white	1001884
Down: 2750/2900lm   3000/4000K   CRI>80 Up: 50lm   3000/4000K   CRI>80	
■ grey	1001885

MEDO 60 AMBIENT  
CW, PHASE



- With ambient effect
- Colour temperature (3000K/4000K) can be adjusted using the switch
- Can be converted to a pendant light using accessories that are separately available

Product details

220-240V ~50/60Hz | 1050mA  
Total wattage: 40W  
Material: aluminium/polycarbonate (PC)  
Dimmable: C

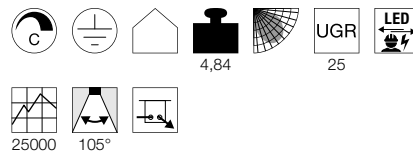

Dimensional drawing

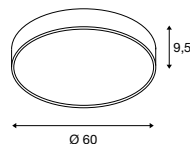

Tip

Suspension set not included

Accessory recommendation

- Suspension kit 1.5m  
Item No. 135250
- Suspension kit 1.5m  
Item No. 135251
- Suspension kit 1.5m  
Item No. 135254
- Suspension kit 5m  
Item No. 1001950
- Suspension kit 5m  
Item No. 1001951
- Suspension kit 5m  
Item No. 1001952

Variant	Item No.
Down: 4350/4750lm   3000/4000K   CRI>80 Up: 120lm   3000/4000K   CRI>80	
■ black	1001886
Down: 4350/4750lm   3000/4000K   CRI>80 Up: 120lm   3000/4000K   CRI>80	
□ white	1001887
Down: 4350/4750lm   3000/4000K   CRI>80 Up: 120lm   3000/4000K   CRI>80	
■ grey	1001888

MEDO 90 AMBIENT  
CL, PHASE



- With ambient effect
- Colour temperature (3000K/4000K) can be adjusted using the switch
- Can be converted to a pendant light using accessories that are separately available

Product details

220-240V ~50/60Hz | 1050mA  
Total wattage: 78W  
Material: aluminium/polycarbonate (PC)  
Dimmable: C

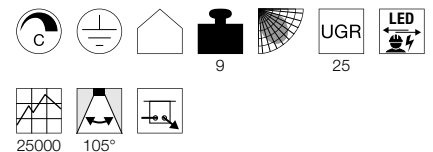

Dimensional drawing

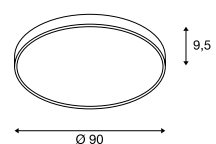

Tip

Suspension set not included

Accessory recommendation

- Suspension kit 1.5m  
Item No. 135250
- Suspension kit 1.5m  
Item No. 135251
- Suspension kit 1.5m  
Item No. 135254
- Suspension kit 5m  
Item No. 1001950
- Suspension kit 5m  
Item No. 1001951
- Suspension kit 5m  
Item No. 1001952

Variant	Item No.
Down: 9500/10100lm   3000/4000K   CRI>80 Up: 125lm   3000/4000K   CRI>80	
■ black	1001878
Down: 9500/10100lm   3000/4000K   CRI>80 Up: 125lm   3000/4000K   CRI>80	
□ white	1001879
Down: 9500/10100lm   3000/4000K   CRI>80 Up: 125lm   3000/4000K   CRI>80	
■ grey	1001880

MEDO 30 AMBIENT  
CW, DALI



- With ambient effect
- Colour temperature (3000K/4000K) can be adjusted using the switch
- Can be converted to a pendant light using accessories that are separately available

Product details

220-240V ~50/60Hz | 350mA  
Total wattage: 15W  
Material: aluminium/polycarbonate (PC)  
Dimmable: Dali

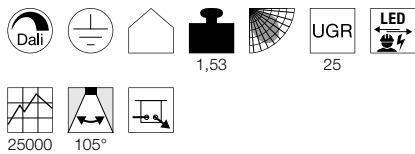

Dimensional drawing

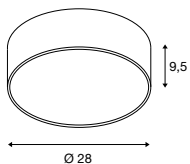

Tip

Suspension set not included

Accessory recommendation

- Suspension kit 1.5m  
Item No. 135250
- Suspension kit 1.5m  
Item No. 135251
- Suspension kit 1.5m  
Item No. 135254
- Suspension kit 5m  
Item No. 1001950
- Suspension kit 5m  
Item No. 1001951
- Suspension kit 5m  
Item No. 1001952

Variant	Item No.
Down: 1230/1280lm   3000/4000K   CRI>80 Up: 20lm   3000/4000K   CRI>80	
■ black	1001889
Down: 1230/1280lm   3000/4000K   CRI>80 Up: 20lm   3000/4000K   CRI>80	
□ white	1001893
Down: 1230/1280lm   3000/4000K   CRI>80 Up: 20lm   3000/4000K   CRI>80	
■ grey	1001894

MEDO 40 AMBIENT  
CW, DALI



- With ambient effect
- Colour temperature (3000K/4000K) can be adjusted using the switch
- Can be converted to a pendant light using accessories that are separately available

Product details

220-240V ~50/60Hz | 700mA  
Total wattage: 30W  
Material: aluminium/polycarbonate (PC)  
Dimmable: Dali

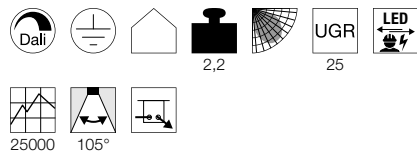

Dimensional drawing

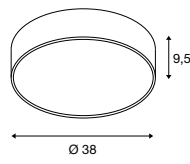

Tip

Suspension set not included

Accessory recommendation

- Suspension kit 1.5m  
Item No. 135250
- Suspension kit 1.5m  
Item No. 135251
- Suspension kit 1.5m  
Item No. 135254
- Suspension kit 5m  
Item No. 1001950
- Suspension kit 5m  
Item No. 1001951
- Suspension kit 5m  
Item No. 1001952

Variant	Item No.
Down: 2750/2900lm   3000/4000K   CRI>80 Up: 50lm   3000/4000K   CRI>80	
■ black	1001895
Down: 2750/2900lm   3000/4000K   CRI>80 Up: 50lm   3000/4000K   CRI>80	
□ white	1001896
Down: 2750/2900lm   3000/4000K   CRI>80 Up: 50lm   3000/4000K   CRI>80	
■ grey	1001897

MEDO 60 AMBIENT  
CW, DALI



- With ambient effect
- Colour temperature (3000K/4000K) can be adjusted using the switch
- Can be converted to a pendant light using accessories that are separately available

Product details

220-240V ~50/60Hz | 1000mA  
Total wattage: 40W  
Material: aluminium/polycarbonate (PC)  
Dimmable: Dali

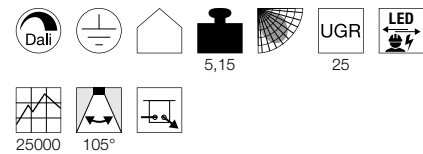

Dimensional drawing

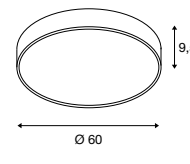

Tip

Suspension set not included

Accessory recommendation

- Suspension kit 1.5m  
Item No. 135250
- Suspension kit 1.5m  
Item No. 135251
- Suspension kit 1.5m  
Item No. 135254
- Suspension kit 5m  
Item No. 1001950
- Suspension kit 5m  
Item No. 1001951
- Suspension kit 5m  
Item No. 1001952

Variant	Item No.
Down: 4350/4750lm   3000/4000K   CRI>80 Up: 120lm   3000/4000K   CRI>80	
■ black	1001898
Down: 4350/4750lm   3000/4000K   CRI>80 Up: 120lm   3000/4000K   CRI>80	
□ white	1001900
Down: 4350/4750lm   3000/4000K   CRI>80 Up: 120lm   3000/4000K   CRI>80	
■ grey	1001899



1001899 150

MEDO 90 AMBIENT  
CL, DALI

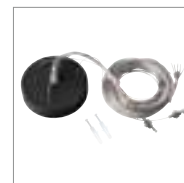

- With ambient effect
- Colour temperature (3000K/4000K) can be adjusted using the switch
- Can be converted to a pendant light using accessories that are separately available

Product details

220-240V ~50/60Hz | 1000mA  
Total wattage: 78W  
Material: aluminium/polycarbonate (PC)  
Dimmable: Dali

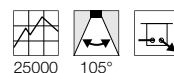

Dimensional drawing

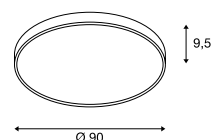

Tip

Suspension set not included

Accessory recommendation

- Suspension kit 1.5m  
Item No. 135250
- Suspension kit 1.5m  
Item No. 135251
- Suspension kit 1.5m  
Item No. 135254
- Suspension kit 5m  
Item No. 1001950
- Suspension kit 5m  
Item No. 1001951
- Suspension kit 5m  
Item No. 1001952

Variant	Item No.
Down: 9500/10100lm   3000/4000K   CRI>80 Up: 125lm   3000/4000K   CRI>80	1001890
■ black	
Down: 9500/10100lm   3000/4000K   CRI>80 Up: 125lm   3000/4000K   CRI>80	1001891
□ white	
Down: 9500/10100lm   3000/4000K   CRI>80 Up: 125lm   3000/4000K   CRI>80	1001892
■ grey	

MEDO 60  
CL, square, 1-10V



- Can be converted to a pendant light using accessories that are separately available

Product details

100-240V ~50/60Hz | 1000mA  
Systemleistung: 39W  
Material: aluminium/acrylic  
Dimmable: 1-10V

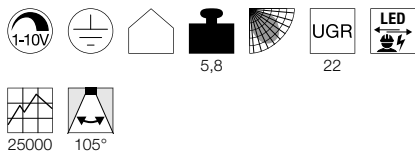

Dimensional drawing

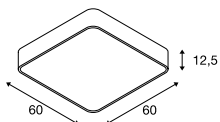

Tip

Suspension set not included

Accessory recommendation

- Suspension kit 1.5m  
Item No. 135250
- Suspension kit 1.5m  
Item No. 135251
- Suspension kit 1.5m  
Item No. 135254
- 1-10V dimming  
Item No. 470505
- Suspension kit 5m  
Item No. 1001950
- Suspension kit 5m  
Item No. 1001951
- Suspension kit 5m  
Item No. 1001952

Variant	Item No.
3300lm   3000K   CRI>80 <input checked="" type="checkbox"/> black	1000725
3300lm   3000K   CRI>80 <input type="checkbox"/> white	1000726
3300lm   3000K   CRI>80 <input checked="" type="checkbox"/> grey	1000727





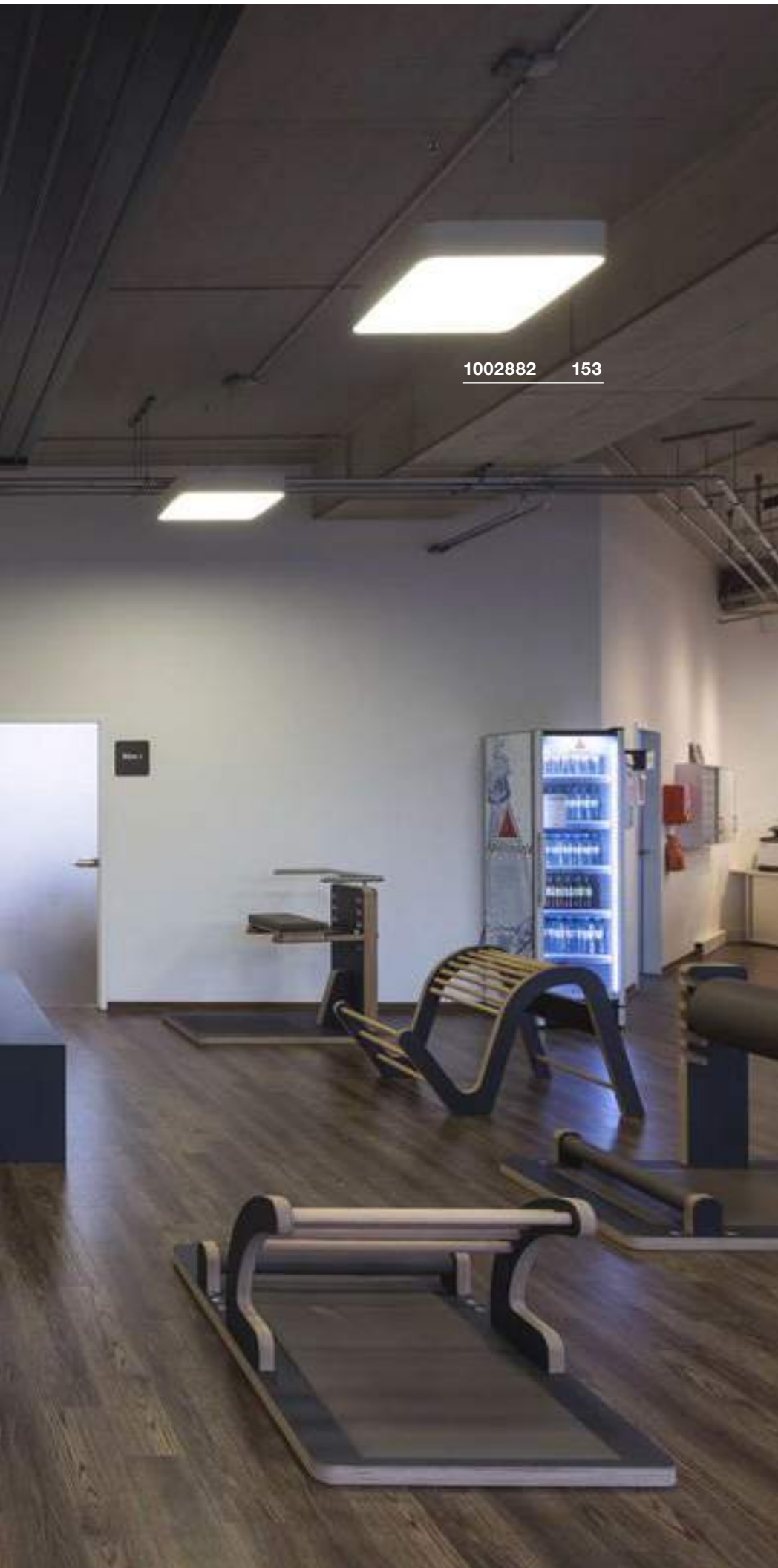

1002882 153

MEDO 60  
CL, square, DALI



- Can be converted to a pendant light using accessories that are separately available

Product details

100-277V ~50/60Hz | 1000mA  
Systemleistung: 39W  
Material: aluminium/acrylic  
Dimmable: Dali

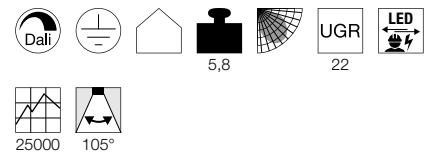

Dimensional drawing

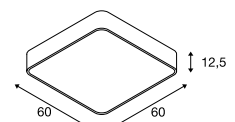

Tip

Suspension set not included

Accessory recommendation

- Suspension kit 1.5m  
Item No. 135250
- Suspension kit 1.5m  
Item No. 135251
- Suspension kit 1.5m  
Item No. 135254
- Suspension kit 5m  
Item No. 1001950
- Suspension kit 5m  
Item No. 1001951
- Suspension kit 5m  
Item No. 1001952

Variant	Item No.
3300lm   3000K   CRI>80 <input type="checkbox"/> white	1002882

MEDO RING 60  
PD,1-10V



- Height adjustable

Product details

120-240V ~50/60Hz | 700mA  
Total wattage: 35W  
Material: aluminium/polymethylacrylate (PMMA)  
Dimmable: 1-10V

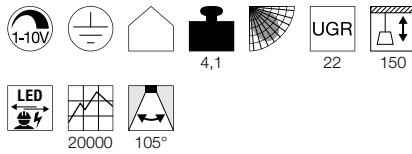

Dimensional drawing

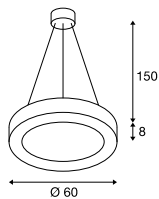

Accessory recommendation

- 1-10V dimming
- Item No. 470505



Variant	Item No.
2000lm   3000K   CRI>80	
■ black	133840
2095lm   3000K   CRI>80	
□ white	133841

MEDO RING 90  
PD,1-10V



- Height adjustable

Product details

100-240V ~50/60Hz | 1200mA  
Total wattage: 58W  
Material: aluminium/polymethylacrylate (PMMA)  
Dimmable: 1-10V

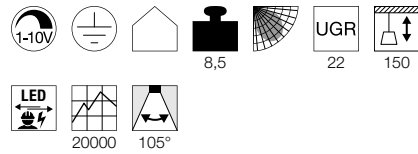

Dimensional drawing

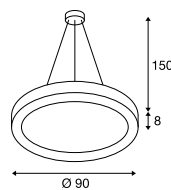

Accessory recommendation

- 1-10V dimming
- Item No. 470505



Variant	Item No.
3945lm   3000K   CRI>80	
■ black	133850
4185lm   3000K   CRI>80	
□ white	133851





1002890 155

MEDO RING 60  
PD, DALI



- Height adjustable

Product details

220-240V ~50/60Hz | 700mA  
 Total wattage: 34W  
 Material: aluminium/polymethylacrylate (PMMA)  
 Dimmable: Dali

4,1      22      150  
 20000      105°

Dimensional drawing

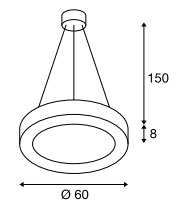

133840 154

Variant	Item No.
2000lm   3000K   CRI>80	
■ black	1002890
2095lm   3000K   CRI>80	
□ white	1002891

1002913 157



1002912 157



ONE TRIPLE  
PD, DALI

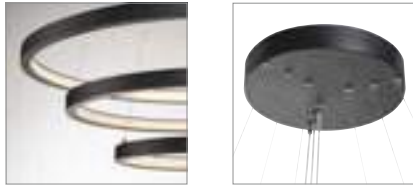

- Height adjustable
- The light colour can be selected during installation using a switch

Product details

220-240V 0/~50/60Hz | 1700mA  
Total wattage: 65W  
Material: aluminium/steel  
Dimmable: Dali

Dimensional drawing

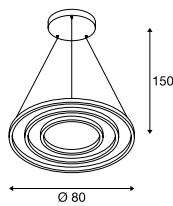

ONE 60  
PD, DALI

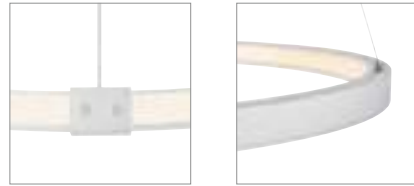

- Height adjustable
- The light colour can be selected during installation using a switch

Product details

220-240V ~50/60Hz | 600mA  
Total wattage: 25W  
Material: aluminium/steel  
Dimmable: Dali

Dimensional drawing

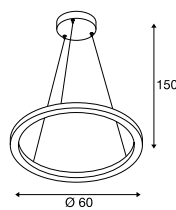

ONE 80  
PD, DALI



- Height adjustable
- The light colour can be selected during installation using a switch

Product details

220-240V ~50/60Hz | 800mA  
Total wattage: 35W  
Material: aluminium/steel  
Dimmable: Dali

Dimensional drawing

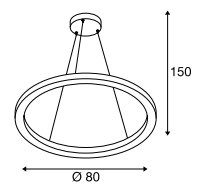

Variant	Item No.
3900/4200lm   3000/4000K   CRI>80	
■ matt black	1002913
3900/4200lm   3000/4000K   CRI>80	
□ matt white	1002914

Variant	Item No.
3900/4200lm   3000/4000K   CRI>80	
■ matt black	1002909
3900/4200lm   3000/4000K   CRI>80	
□ matt white	1002910

Variant	Item No.
2000/2200lm   3000/4000K   CRI>80	
■ matt black	1002911
2000/2200lm   3000/4000K   CRI>80	
□ matt white	1002912

ONE 60  
PD, PHASE, up/down



NEW VARIANT

LED INSIDE

CCT



- The light colour can be selected during installation using a switch
- Height adjustable

Product details

220-240V ~50/60Hz | 600mA  
Total wattage: 24W  
Material: aluminium/steel  
Dimmable: C

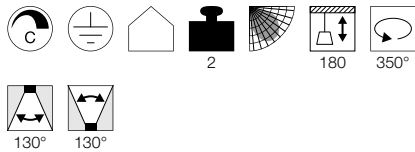

Dimensional drawing

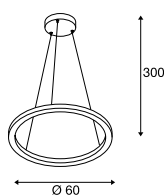

ONE 60  
PD, DALI, up/down



NEW VARIANT

LED INSIDE

CCT

DALI



- The light colour can be selected during installation using a switch
- Height adjustable

Product details

220-240V ~50/60Hz | 600mA  
Total wattage: 25W  
Material: aluminium/steel  
Dimmable: Dali

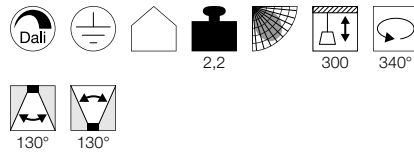

Dimensional drawing

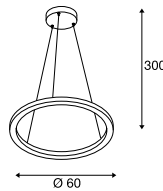

ONE 80  
PD, DALI, up/down



NEW VARIANT

LED INSIDE

CCT

DALI



- The light colour can be selected during installation using a switch
- Height adjustable

Product details

220-240V ~50/60Hz | 800mA  
Total wattage: 34W  
Material: aluminium/steel  
Dimmable: Dali

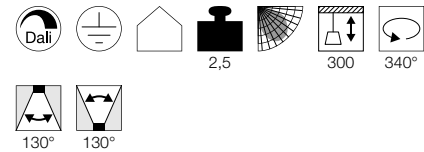

Dimensional drawing

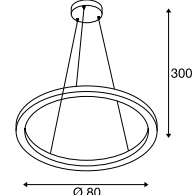

Variant	Item No.
Up: 410/415lm   2700/3000K   CRI90 Down: 410/415lm   2700/3000K   CRI90	
■ matt black	1004759
Up: 410/415lm   2700/3000K   CRI90 Down: 410/415lm   2700/3000K   CRI90	
□ matt white	1004760

Variant	Item No.
Up: 400/410lm   3000/4000K   CRI90 Down: 400/410lm   3000/4000K   CRI90	
■ matt black	1004761
Up: 400/410lm   3000/4000K   CRI90 Down: 400/410lm   3000/4000K   CRI90	
□ matt white	1004762

Variant	Item No.
Up: 615/635lm   3000/4000K   CRI90 Down: 615/635lm   3000/4000K   CRI90	
■ matt black	1004763
Up: 615/635lm   3000/4000K   CRI90 Down: 615/635lm   3000/4000K   CRI90	
□ matt white	1004764



ONE DOUBLE  
PD, PHASE, up/down



- The light colour can be selected during installation using a switch
- Height adjustable

Product details

220-240V ~50/60Hz | 900mA  
Total wattage: 35W  
Material: aluminium/steel  
Dimmable: C

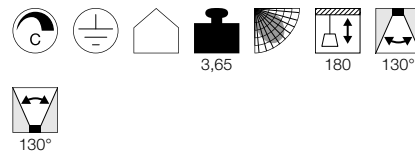

Dimensional drawing

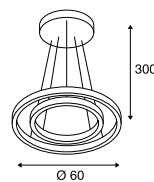

ONE DOUBLE  
PD, DALI, up/down



- The light colour can be selected during installation using a switch
- Height adjustable

Product details

220-240V ~50/60Hz | 1400mA  
Total wattage: 55W  
Material: aluminium/steel  
Dimmable: Dali

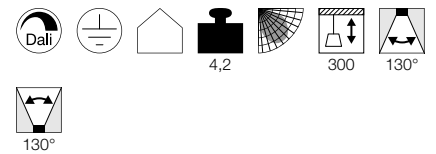

Dimensional drawing

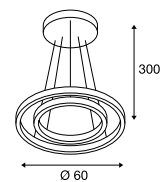

Variant	Item No.
Up: 615/635lm   2700/3000K   CRI90 Down: 615/635lm   2700/3000K   CRI90	
■ matt black	<b>1004765</b>
Up: 615/635lm   2700/3000K   CRI90 Down: 615/635lm   2700/3000K   CRI90	
□ matt white	<b>1004766</b>

Variant	Item No.
Up: 1050/1060lm   3000/4000K   CRI90 Down: 1050/1060lm   3000/4000K   CRI90	
■ matt black	<b>1004767</b>
Up: 1050/1060lm   3000/4000K   CRI90 Down: 1050/1060lm   3000/4000K   CRI90	
□ matt white	<b>1004768</b>

PANEL 60  
PD, 1-10V



1001344 160



- Height adjustable

Product details

100-240V ~50/60Hz | 1000mA  
 Total wattage: 42W  
 Material: aluminium/polymethylacrylate (PMMA)  
 Dimmable: 1-10V

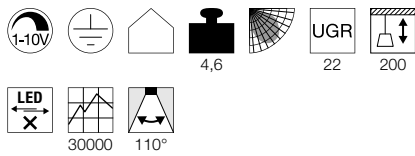

Dimensional drawing

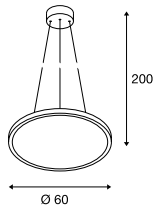

Accessory recommendation

1-10V dimming  
 Item No. 470505 

Variant	Item No.
3150lm   3000K   CRI>80 white	1001344
3350lm   4000K   CRI>80 white	1001345
3150lm   3000K   CRI>80 grey	1001347
3350lm   4000K   CRI>80 grey	1001348







1003045 161

## PANEL 60

PD, round, DALI



- Height adjustable

### Product details

100-277V ~50/60Hz | 1000mA

Total wattage: 42W

Material: aluminium/polymethylacrylate (PMMA)

Dimmable: Dali

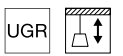

4,6

22

200



30000

110°

### Dimensional drawing

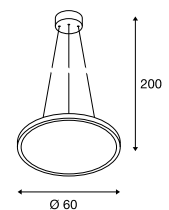

Variant	Item No.
3150lm   3000K   CRI>80	
□ white	<b>1003044</b>
3350lm   4000K   CRI>80	
□ white	<b>1003045</b>
3150lm   3000K   CRI>80	
■ grey	<b>1003046</b>
3350lm   4000K   CRI>80	
■ grey	<b>1003047</b>



1003051 163

I-PENDANT PRO  
PD, 1195x295mm, 1-10V



- Height adjustable

Product details

100-240V ~50/60Hz | 1000mA  
Total wattage: 42W  
Material: aluminium/acrylic  
Dimmable: 1-10V

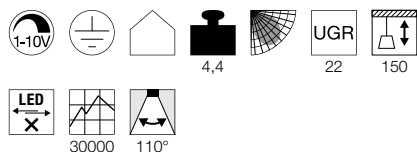

Dimensional drawing

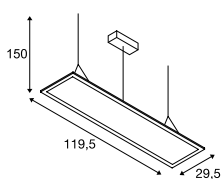

Accessory recommendation

1-10V dimming  
Item No. 470505

Variant	Item No.
3100lm   3000K   CRI>80 <input type="checkbox"/> white	158723
3550lm   4000K   CRI>80 <input type="checkbox"/> white	158724
3100lm   3000K   CRI>80 <input checked="" type="checkbox"/> grey	158733
3550lm   4000K   CRI>80 <input checked="" type="checkbox"/> grey	158734

I-PENDANT PRO  
PD, 1195x295mm, UGR<19, 1-10V



- Height adjustable
- UGR <19
- Suitable for screen-based workstations

Product details

100-240V ~50/60Hz | 1000mA  
Total wattage: 42W  
Material: aluminium/polymethylacrylate (PMMA)  
Dimmable: 1-10V

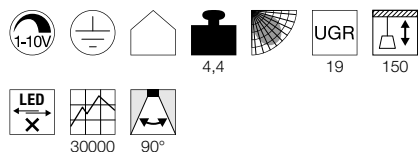

Dimensional drawing

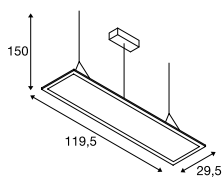

Accessory recommendation

1-10V dimming  
Item No. 470505

Variant	Item No.
3750lm   3000K   CRI>80 <input type="checkbox"/> white	1001447
3800lm   4000K   CRI>80 <input type="checkbox"/> white	1001448
3750lm   3000K   CRI>80 <input checked="" type="checkbox"/> grey	1001647
3800lm   4000K   CRI>80 <input checked="" type="checkbox"/> grey	1001648

I-PENDANT PRO  
PD, 1195x295mm, DALI



- Height adjustable
- UGR<19
- Suitable for screen-based workstations in line with EN 12464-1

Product details

100-277V ~50/60Hz | 1000mA  
Total wattage: 42W  
Material: aluminium/polymethylacrylate (PMMA)  
Dimmable: Dali

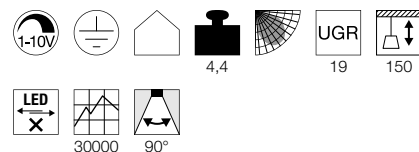

Dimensional drawing

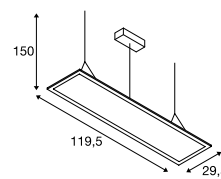

Accessory recommendation

1-10V dimming  
Item No. 470505

Variant	Item No.
3750lm   3000K   CRI>80 <input type="checkbox"/> white	1003048
3800lm   4000K   CRI>80 <input type="checkbox"/> white	1003049
3750lm   3000K   CRI>80 <input checked="" type="checkbox"/> grey	1003050
3800lm   4000K   CRI>80 <input checked="" type="checkbox"/> grey	1003051

HANG UP 120  
PD, PHASE



- Height adjustable

Product details

220-240V ~50/60Hz | 250mA  
Total wattage: 41W  
Material: aluminium/plastic  
Dimmable: C

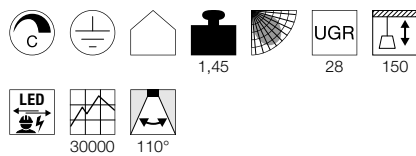

Dimensional drawing

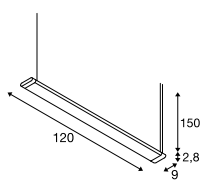

Tip

Rose not included  
Open cable end

Accessory recommendation

- Ceiling rose  
Item No. 210060
- Ceiling rose  
Item No. 210061
- Ceiling rose  
Item No. 210064

Variant	Item No.
4000lm   3000K   CRI>80 <input checked="" type="checkbox"/> black	160900
4000lm   3000K   CRI>80 <input type="checkbox"/> white	160901
4000lm   3000K   CRI>80 <input checked="" type="checkbox"/> grey	160904





1003530 165

NOYA  
PD, PHASE

NEW

LED  
INSIDE

CCT



Product details

220-240V ~50/60Hz | 700mA

Total wattage: 32W

Material: aluminium/polycarbonate (PC)

Dimmable: C



115°

Dimensional drawing

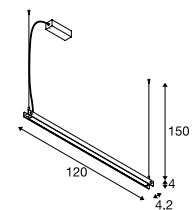

1003532 165

Variant	Item No.
1861/2025lm   2700/3000K   CRI>90	
■ matt black	1003530
1861/2025lm   2700/3000K   CRI>90	
□ matt white	1003532

# LIGHTING HIGHLIGHTS.

## OUR PERFECT LIGHTING FOR YOUR WORKSTATION.



1003528 177



GLENOS® 1m | 2m | 168



Q-LINE® PD, single | 169



Q-LINE® PD, DALI single | 169

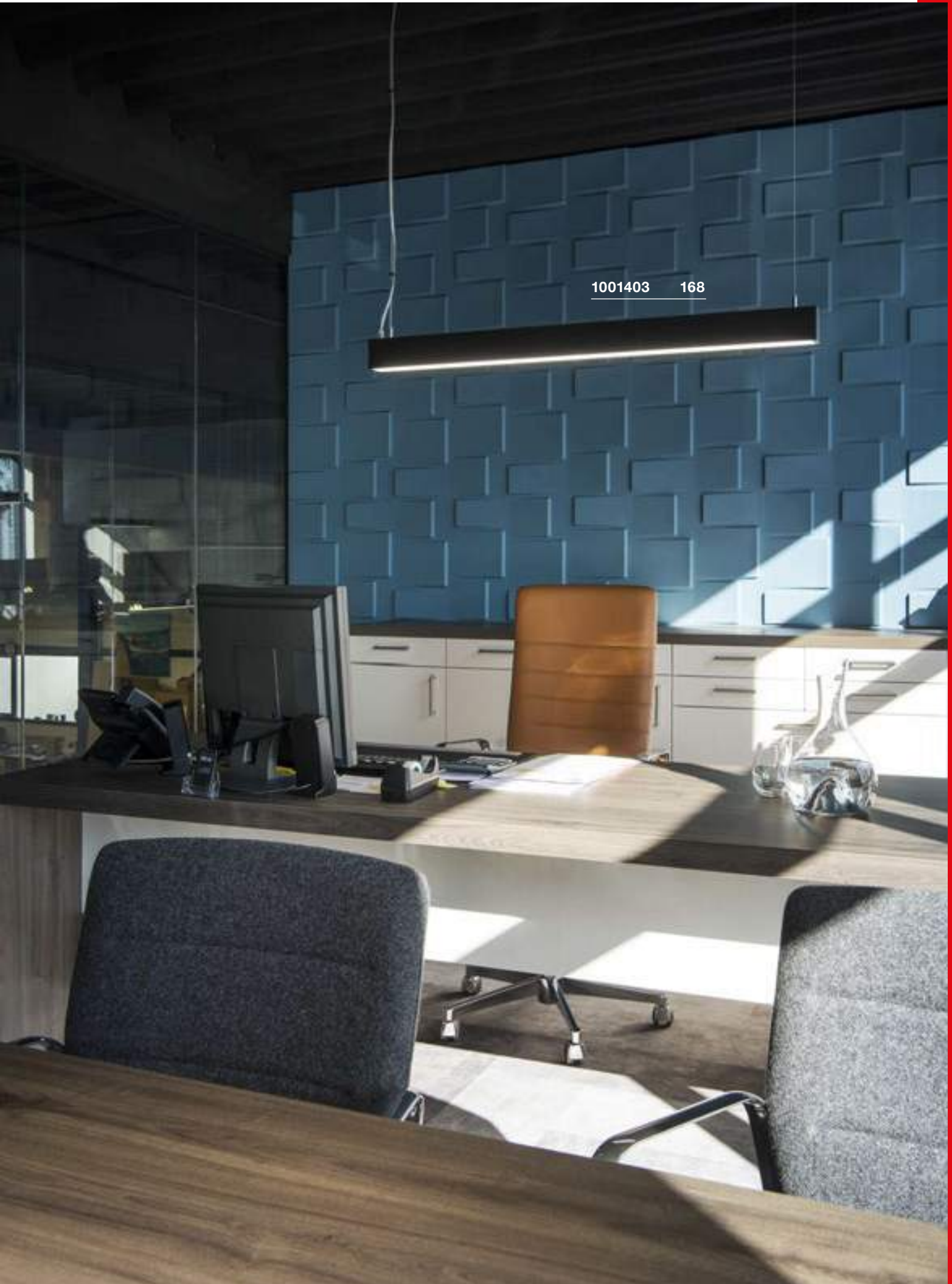

1001403 168

GLENOS  
PD, 1m, 1-10V



- Height adjustable

Product details

220-240V ~50/60Hz | 1000mA  
Total wattage: 43W  
Material: aluminium/plastic  
Dimmable: 1-10V

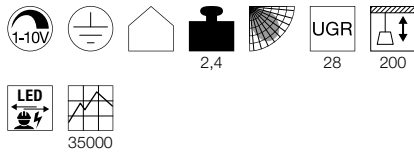

Dimensional drawing

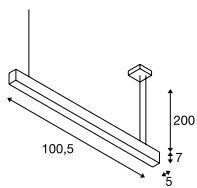

Accessory recommendation

1-10V dimming  
Item No. 470505



Variant	Item No.
2850lm   3000K   CRI>80	
■ matt black	1001400
2850lm   3000K   CRI>80	
□ matt white	1001401
3300lm   4000K   CRI>80	
■ matt black	1001403
3300lm   4000K   CRI>80	
□ matt white	1001404

GLENOS  
PD, 2m, 1-10V



- Height adjustable

Product details

220-240V ~50/60Hz | 1000mA  
Total wattage: 85W  
Material: aluminium/plastic  
Dimmable: 1-10V

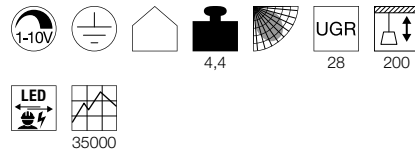

Dimensional drawing

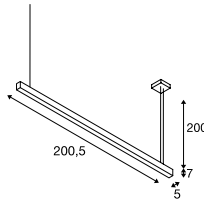

Accessory recommendation

1-10V dimming  
Item No. 470505

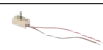

Variant	Item No.
5700lm   3000K   CRI>80	
■ matt black	1001406
5700lm   3000K   CRI>80	
□ matt white	1001407
6600lm   4000K   CRI>80	
■ matt black	1001409
6600lm   4000K   CRI>80	
□ matt white	1001410

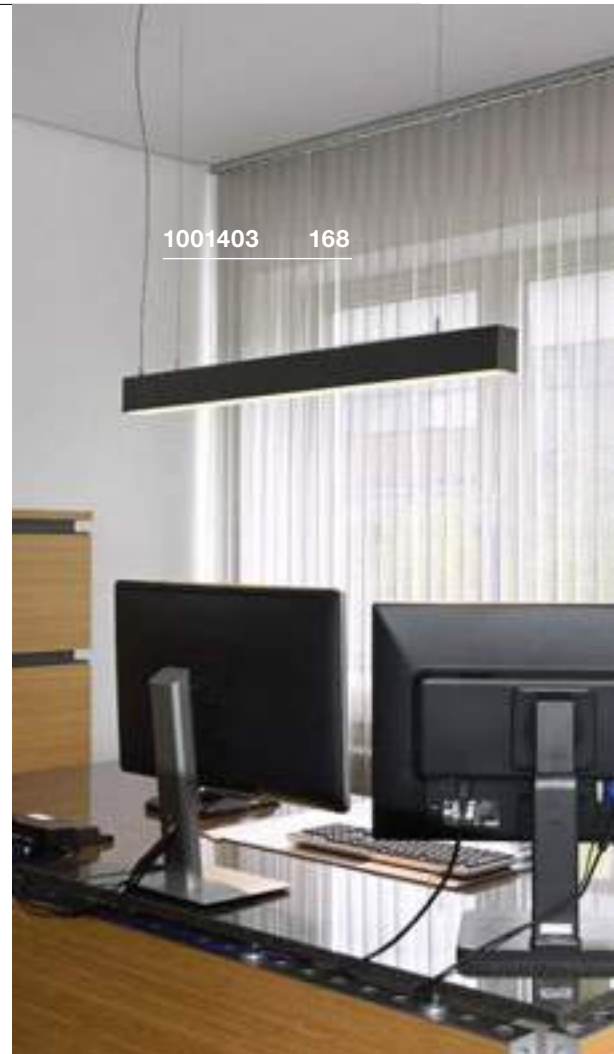

1001403 168

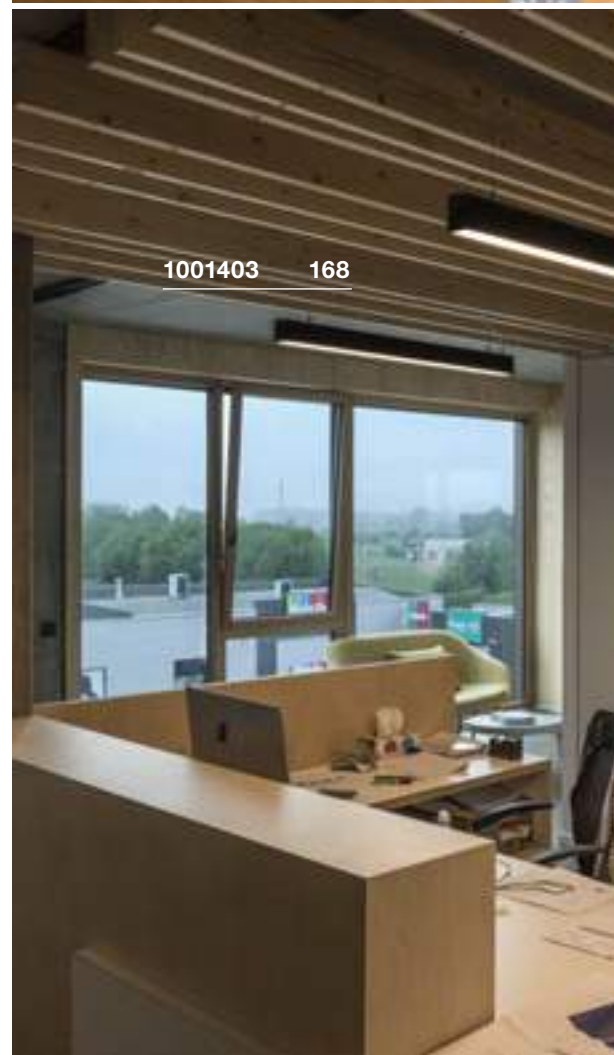

1001403 168





1001306 169



1001409 168

Q-LINE®  
PD, single

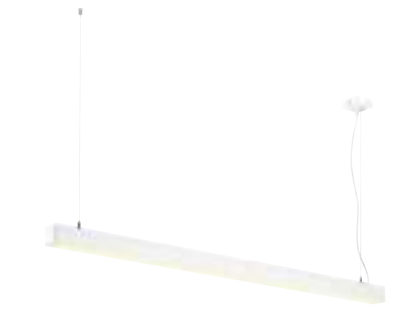

- Height adjustable

Product details

220-240V ~50/60Hz | 700mA  
Total wattage: 45.8W  
Material: aluminium/acrylic

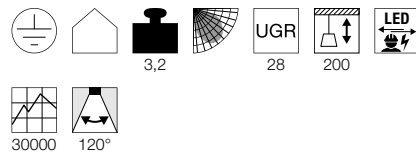

Dimensional drawing

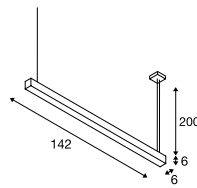

Variant	Item No.
3700lm   3000K   CRI>80	
■ black	1001306
3700lm   3000K   CRI>80	
□ white	1001307
3700lm   3000K   CRI>80	
■ grey	1001308 ▼

Q-LINE®  
PD, DALI, single

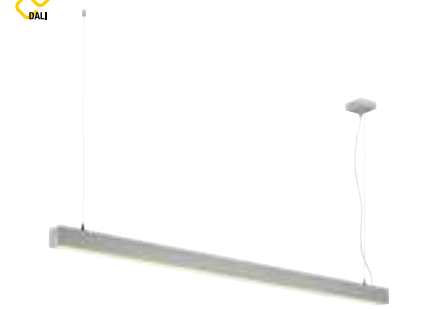

- Height adjustable

Product details

220-240V ~50/60Hz | 350mA-1050mA  
Total wattage: 47W  
Material: aluminium/acrylic  
Dimmable: Dali, switch

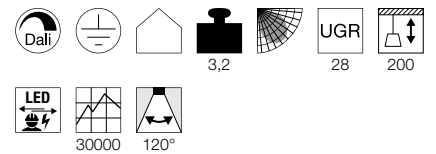

Dimensional drawing

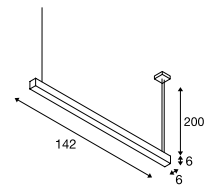

Variant	Item No.
3700lm   3000K   CRI>80	
■ black	1001309
3700lm   3000K   CRI>80	
□ white	1001310
3700lm   3000K   CRI>80	
■ grey	1001312 ▼

**Q-LINE®**  
PD, 1m, BAP, PHASE



- Premium LED with CRI>90
- Height adjustable

**Product details**

220-240V ~50/60Hz | 900mA  
Total wattage: 45W  
Material: aluminium/plastic  
Dimmable: L

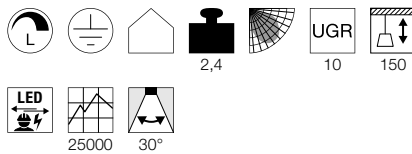

**Dimensional drawing**

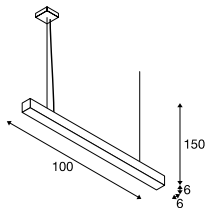

**Q-LINE®**  
PD, 2m, BAP, PHASE



- Premium LED with CRI>90
- Height adjustable

**Product details**

220-240V ~50/60Hz | 900mA  
Total wattage: 85W  
Material: aluminium/plastic  
Dimmable: L

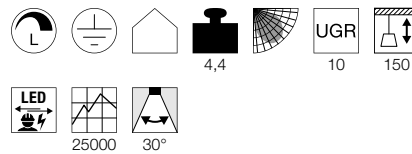

**Dimensional drawing**

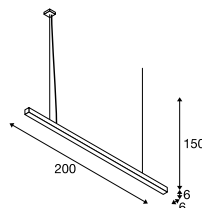

Variant	Item No.
2100lm   3000K   CRI>90 ■ black	<b>1000927</b>
2100lm   3000K   CRI>90 □ white	<b>1000926</b>
2100lm   3000K   CRI>90 ■ grey	<b>1000928 ▼</b>
2300lm   4000K   CRI>90 ■ black	<b>1000933</b>
2300lm   4000K   CRI>90 □ white	<b>1000932</b>
2300lm   4000K   CRI>90 ■ grey	<b>1000934 ▼</b>

Variant	Item No.
4200lm   3000K   CRI>90 ■ black	<b>1000930</b>
4200lm   3000K   CRI>90 □ white	<b>1000929</b>
4200lm   3000K   CRI>90 ■ grey	<b>1000931 ▼</b>
4600lm   4000K   CRI>90 ■ black	<b>1000936</b>
4600lm   4000K   CRI>90 □ white	<b>1000935</b>
4600lm   4000K   CRI>90 ■ grey	<b>1000937 ▼</b>



1000926 170



1000934 170



**OPEN GRILL**  
PD, Single, rotatable

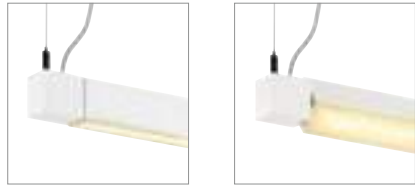

- Height adjustable

**Product details**

220-240V ~50/60Hz | 700mA  
Total wattage: 38W  
Material: aluminium/acrylic

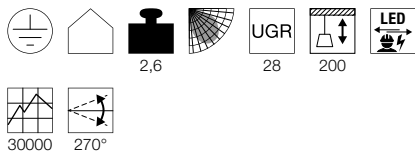

**Dimensional drawing**

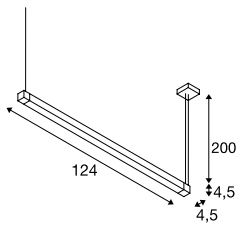

**OPEN GRILL**  
PD, Double, rotatable

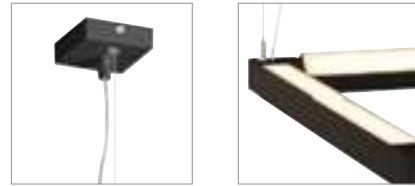

- Height adjustable

**Product details**

220-240V ~50/60Hz | 1050mA  
Total wattage: 54W  
Material: aluminium/acrylic

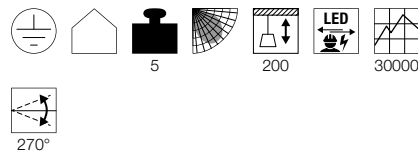

**Dimensional drawing**

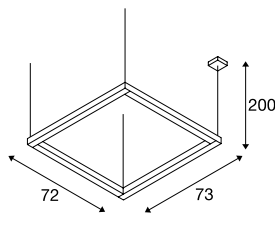

Variant	Item No.
3160lm   3000K   CRI>80	
■ black	1001297
250lm · 3000K · CRI>80	
□ white	157671

Variant	Item No.
4500lm   3000K   CRI>80	
■ black	1001295
4500lm   3000K   CRI>80	
□ white	1001296



159140 173

AIXLIGHT® 150  
PD, R2 Office, PHASE

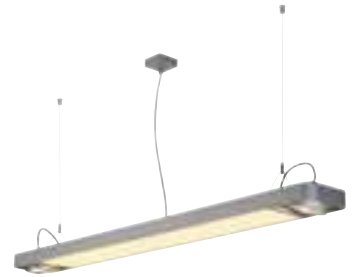

Product details

220-240V ~50/60Hz | 700mA  
Total wattage: 35W  
Material: aluminium/steel  
Dimmable: C, L

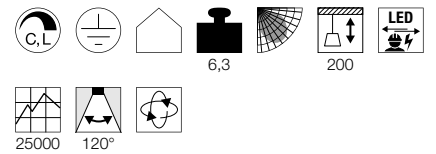

Dimensional drawing

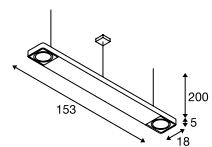

Recommended lamp

LED GU10 13W 55°  
2700K 840lm  
13kWh/1000h  
Item No. 1003094



LED GU10 13W 30°  
4000K 1100lm  
13kWh/1000h  
Item No. 1003087



Lamp details

2x max. 75W QPAR111

Variant	Item No.
GU10   QPAR111 4100lm   4000K   CRI>80	
■ black	<b>159140</b>
GU10   QPAR111 4100lm   4000K   CRI>80	
□ white	<b>159141</b>
GU10   QPAR111 4100lm   4000K   CRI>80	
■ grey/transparent	<b>159144</b>

**AIXLIGHT®**  
PD, R2, double, QPAR111



SOCKET  
INSIDE



**AIXLIGHT®**  
PD, R2, quad, QPAR111



SOCKET  
INSIDE



**AIXLIGHT®**  
PD, R2, quad, QPAR111



SOCKET  
INSIDE

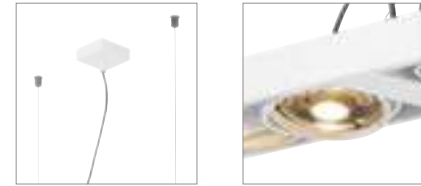

**Product details**

230V -50Hz  
Material: aluminium



**Product details**

230V -50Hz  
Material: aluminium

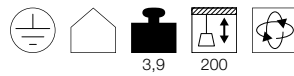

**Product details**

230V -50Hz  
Material: aluminium

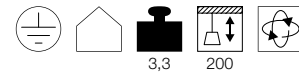

**Dimensional drawing**

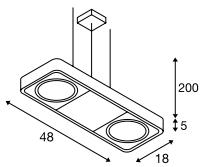

**Dimensional drawing**

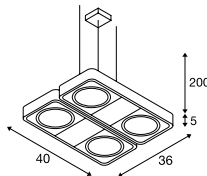

**Dimensional drawing**

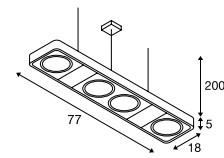

**Recommended lamp**

LED GU10 13W 55°  
2700K 840lm  
13kWh/1000h  
Item No. 1003094



LED GU10 9W 40°  
2700-6500K 765lm  
9kWh/1000h  
Item No. 1001921



**Recommended lamp**

LED GU10 13W 30°  
4000K 1100lm  
13kWh/1000h  
Item No. 1003087



LED GU10 6,5W 38°  
2700K 390lm  
7kWh/1000h  
Item No. 551882



**Recommended lamp**

LED GU10 13W 55°  
4000K 950lm  
13kWh/1000h  
Item No. 1003095



LED GU10 9W 25°  
2700-6500K 765lm  
9kWh/1000h  
Item No. 1001920



**Lamp details**

2x max. 75W QPAR111

Variant	Item No.
GU10   QPAR111	
■ black	159210
GU10   QPAR111	
□ white	159211

**Lamp details**

4x max. 75W QPAR111

Variant	Item No.
GU10   QPAR111	
■ black	159230
GU10   QPAR111	
□ white	159231

**Lamp details**

4x max. 75W QPAR111

Variant	Item No.
GU10   QPAR111	
■ black	159220
GU10   QPAR111	
□ white	159221



159220 174

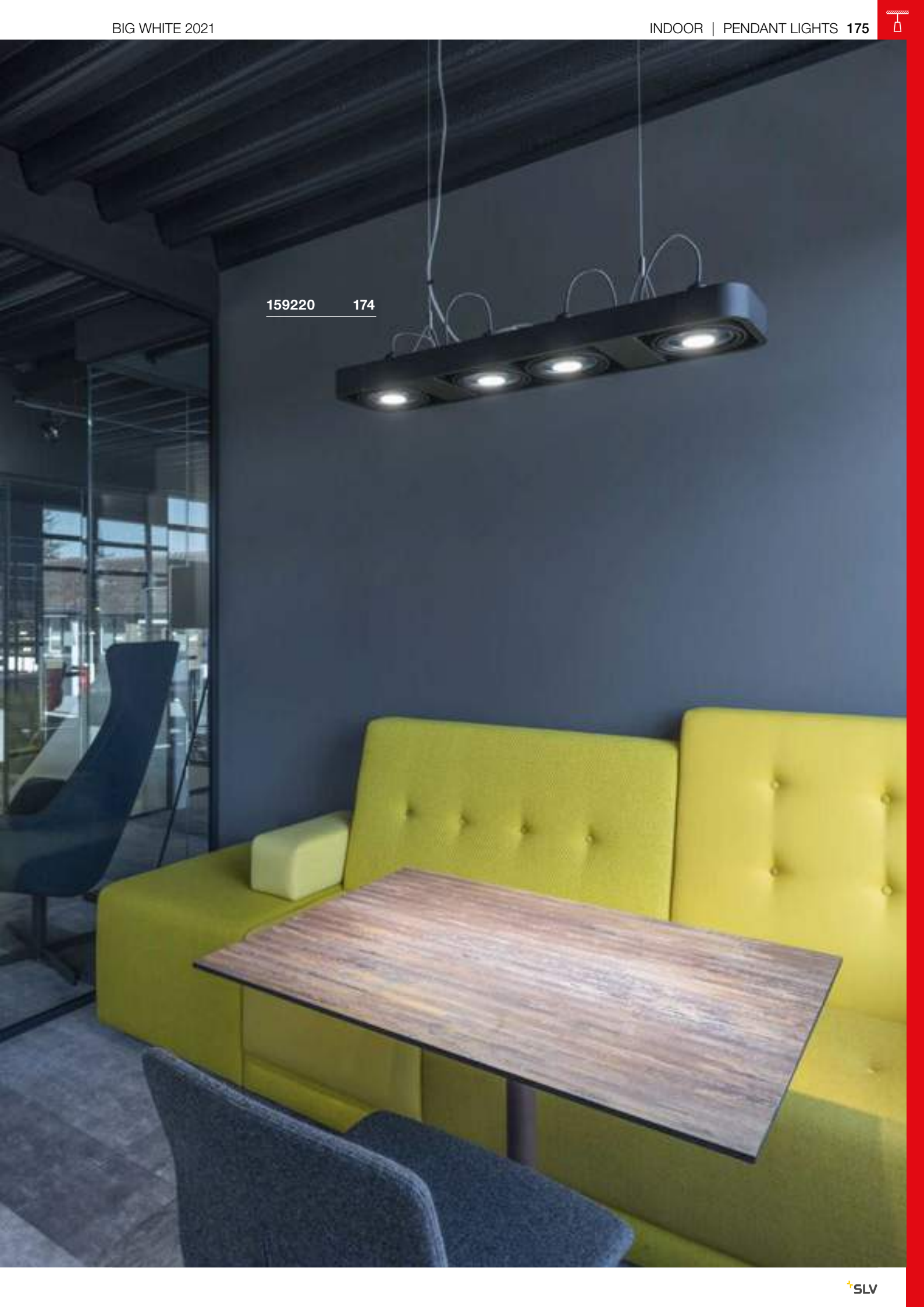

WORKLIGHT  
PD, DALI

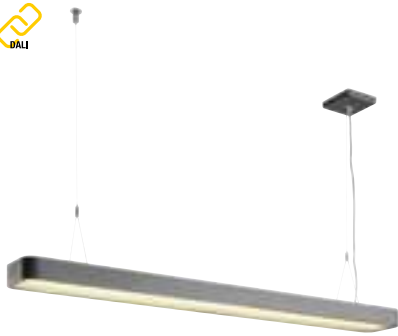

- Height adjustable
- Direct and indirect light

Product details

220-240V ~50/60Hz | 226mA  
 Total wattage: 49W  
 Material: aluminium/acrylic  
 Dimmable: Dali

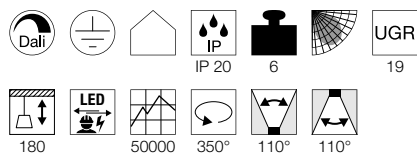

Dimensional drawing

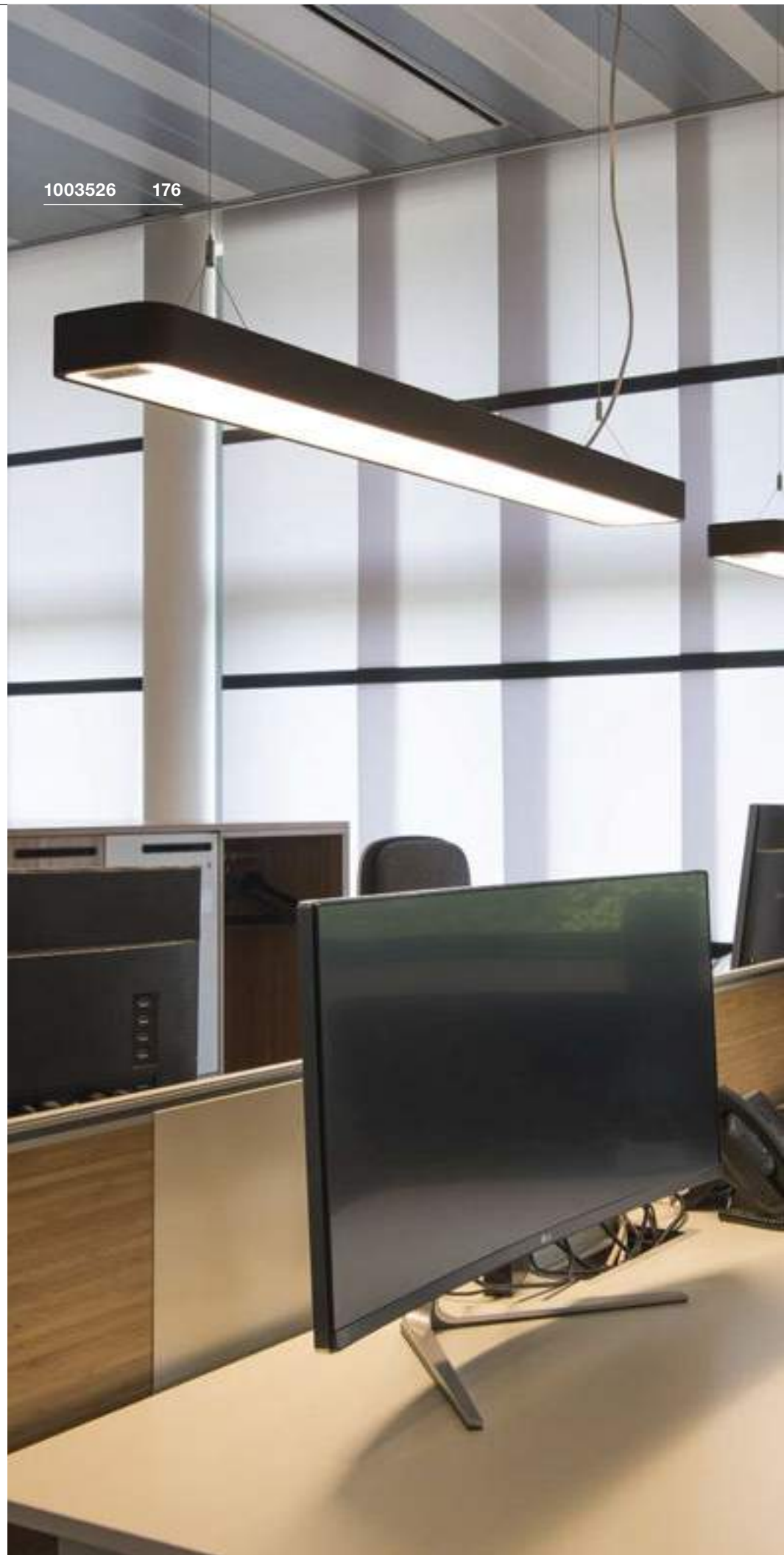
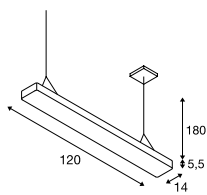

1003526 176

Variant	Item No.
Direct: 3700lm   3000K   CRI>80 Indirect: 1800lm   3000K   CRI>80 □ white	1002838
Direct: 3700lm   3000K   CRI>80 Indirect: 1800lm   3000K   CRI>80 ■ anthracite	1002839
Direct: 3700lm   4000K   CRI>80 Indirect: 1800lm   4000K   CRI>80 □ white	1003525
Direct: 3700lm   4000K   CRI>80 Indirect: 1800lm   4000K   CRI>80 ■ anthracite	1003526





1003527 177

WORKLIGHT PLUS  
PD, Switch



- Intelligent presence control and brightness sensor technology
- Direct and indirect light

Product details

220-240V ~50/60Hz | 226mA  
 Total wattage: 48W  
 Material: aluminium/acrylic  
 Dimmable: switch

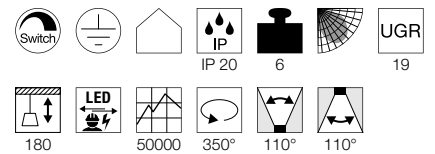

Dimensional drawing

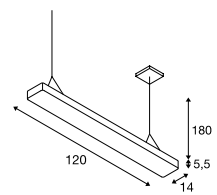

Variant	Item No.
Direct: 3600lm   3000K   CRI>80 Indirect: 1920lm   3000K   CRI>80	
□ white	<b>1002849</b>
Direct: 3600lm   3000K   CRI>80 Indirect: 1920lm   3000K   CRI>80	
■ anthracite	<b>1002850</b>
Direct: 3600lm   4000K   CRI>80 Indirect: 1920lm   4000K   CRI>80	
□ white	<b>1003527</b>
Direct: 3600lm   4000K   CRI>80 Indirect: 1920lm   4000K   CRI>80	
■ anthracite	<b>1003528</b>

SUPROS 78  
PD

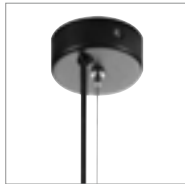

133121 178

Product details

220-240V ~50/60Hz | 250mA  
Total wattage: 12W  
Material: aluminium  
Dimmable: C, L

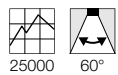

Dimensional drawing

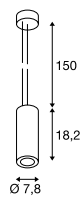

Accessory recommendation

Lens 20°  
Item No. 116302

Lens 40°  
Item No. 116304



Variant	Item No.
700lm   3000K   CRI>80   60°	
■ black	133120
700lm   3000K   CRI>80   60°	
□ white	133121





1003275 179



1003279 179

SUPROS PD



Product details

220-240V ~50/60Hz | 750mA  
 Total wattage: 31W  
 Material: aluminium

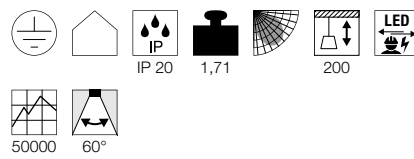

Dimensional drawing

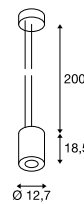

Accessory recommendation

- Reflector 20°
- Item No. 114102
- Reflector 40°
- Item No. 114104

Variant	Item No.
2600lm   3000K   CRI>90   60°	
■ black	1003275
□ white	1003276
2850lm   4000K   CRI>90   60°	
■ black	1003277
□ white	1003278

SUPROS PD



Product details

220-240V ~50/60Hz | 950mA  
 Total wattage: 36W  
 Material: aluminium

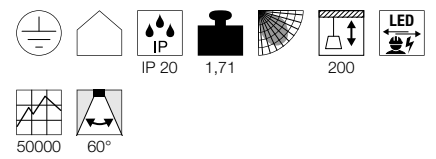

Dimensional drawing

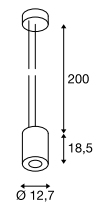

Accessory recommendation

- Reflector 20°
- Item No. 114102
- Reflector 40°
- Item No. 114104

Variant	Item No.
3380lm   3000K   CRI>90   60°	
■ black	1003279
□ white	1003280
3520lm   4000K   CRI>90   60°	
■ black	1003281
□ white	1003282



PARA DOME  
PD, E27

SOCKET  
INSIDE



PARA DOME  
Shade



PARA DOME  
Shade



Product details

230V -50Hz  
Material: aluminium



0,61

Dimensional drawing

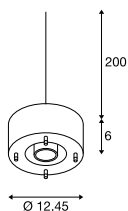

Tip

Open cable end

Recommended lamp

LED E27 15W 350°  
2700K 1300lm  
15kWh/1000h  
Item No. 1003097



LED E27 14.5W 200°  
2700K 1521lm  
15kWh/1000h  
Item No. 560422



Lamp details

max. 150W

Variant	Item No.
E27	
■ black	1002053
E27	
□ white	1002054
E27	
■ grey	1002055

Product details

Material: aluminium  
Product dimensions:  
Diameter: 30.8 cm H: 20.6 cm

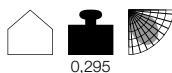

0,295

Product details

Material: Polycarbonate (PC)  
Product dimensions:  
Diameter: 31.5 cm H: 20.5 cm



0,63

Variant	Item No.
■ black	1002056
□ white	1002057
■ grey	1002058

Variant	Item No.
□ transparent	1002059

PARA 380  
PD, E27

SOCKET  
INSIDE

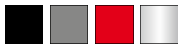

Product details

230V -50Hz  
Material: aluminium



1,1

150

Dimensional drawing

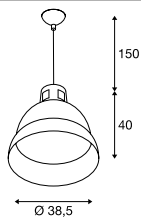

Recommended lamp

LED E27 7W  
2700K 640lm  
7kWh/1000h  
Item No. 1003085



LED E27 7W  
2700K 810lm  
7kWh/1000h  
Item No. 1003090



Lamp details

max. 160W HME-SB

Variant	Item No.
E27   HME-SB	
■ black	165359
E27   HME-SB	
■ grey	165350
E27   HME-SB	
■ glossy red	165356
E27   HME-SB	
■ aluminium	165358

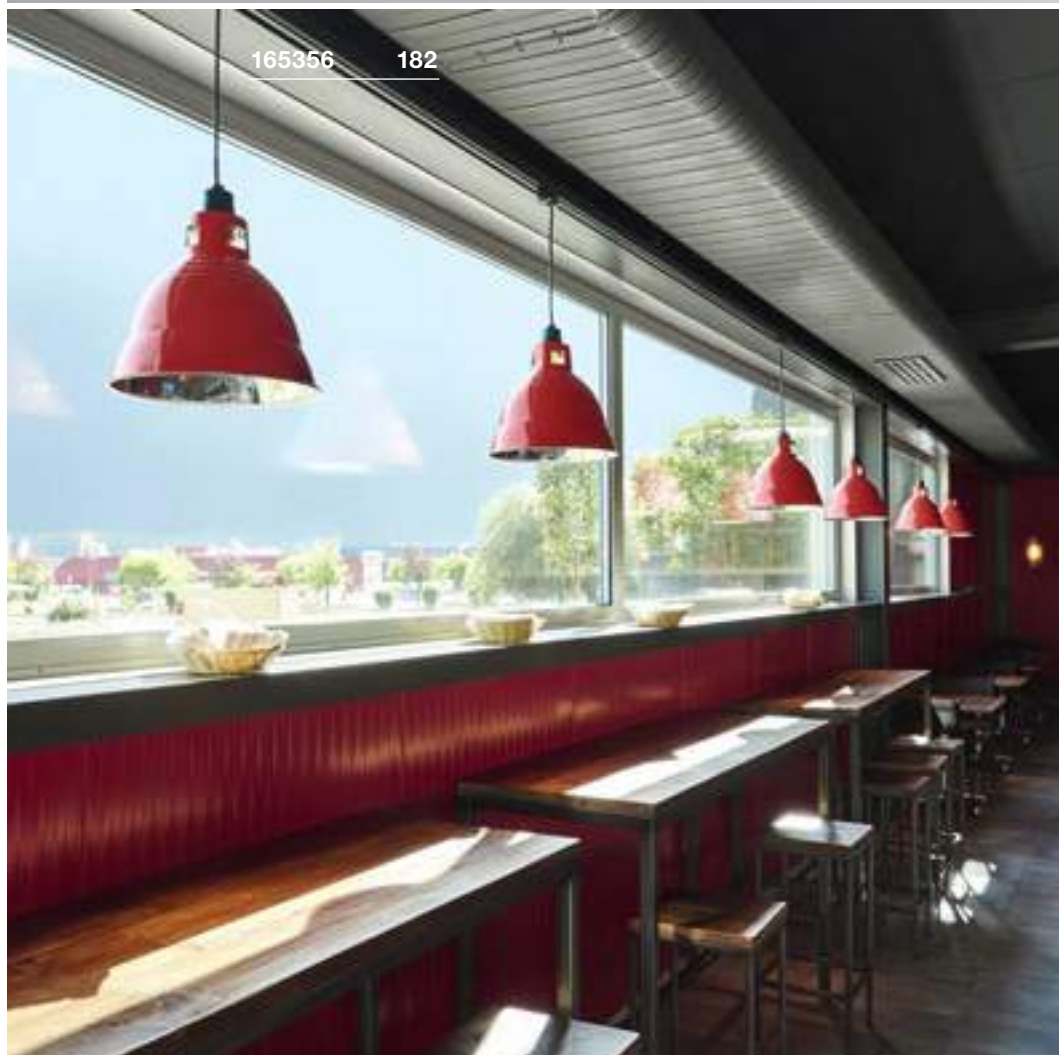



165100 183



165221 183

**PARA DOME**  
PD, E27

SOCKET  
INSIDE



• Wide open lampshade

**Product details**

230V -50Hz  
Material: aluminium/polycarbonate (PC)



**Dimensional drawing**

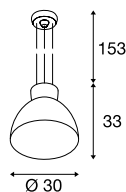

**Recommended lamp**

LED E27 15W 350°  
2700K 1300lm  
15kWh/1000h  
Item No. 1003097



LED E27 14.5W 200°  
2700K 1521lm  
15kWh/1000h  
Item No. 560422



**Lamp details**

max. 150W

Variant	Item No.
E27	
■ anthracite	165100

**PARA MULTI**  
PD, DLMI

LED  
INSIDE



**Product details**

220-240V ~50/60Hz  
Total wattage: 18W  
Material: Steel/acrylic



**Dimensional drawing**

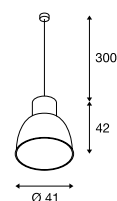

Variant	Item No.
2040lm   4000K   CRI>80	
■ grey	165221
1940lm   3000K   CRI>80	
■ grey	165222

PARA FLAC  
PD/CL



• High light output: >100lm/W

Product details

220-240V ~50/60Hz | 2400mA  
Material: aluminium/polycarbonate (PC)

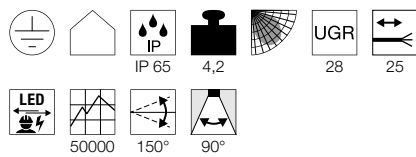

Dimensional drawing

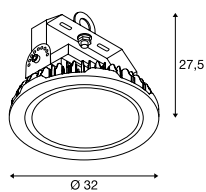

Tip

This product is supplied without a chain and can be hung with standard chains  
Open cable end

Accessory recommendation

■ Connection box IP68, 3-pole  
Item No. 228730

■ Reflector  
Item No. 1000918

□ Refractor  
Item No. 1001691

□ Refractor cover  
Item No. 1001692

Variant	Item No.
12800lm   4000K   CRI>80   104W	
■ matt black	1000827
19200lm   4000K   CRI>80   150W	
■ matt black	1000828



1000828 + 1000918 184





1003107 + 1001691 + 1001692 185

## PARA FLAC PD/CL, DALI



### Product details

220-240V ~50/60Hz | 1600mA  
 Total wattage: 104W  
 Material: aluminium/polycarbonate (PC)  
 Dimmable: Dali

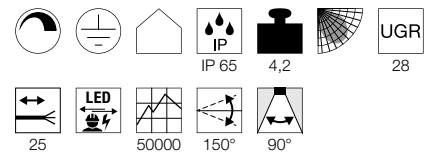

### Dimensional drawing

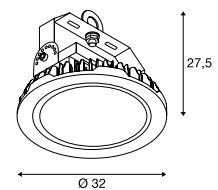

### Tip

This product is supplied without a chain and can be hung with standard chains  
 Open cable end

### Accessory recommendation

■ Connection box IP68, 3-pole  
 Item No. 228730

■ Reflector  
 Item No. 1000918

□ Refractor  
 Item No. 1001691

□ Refractor cover  
 Item No. 1001692

Variant	Item No.
12800lm   4000K   CRI>80	
■ matt black	1003107

# SURPRISINGLY VERSATILE.

WALL LIGHTS PRODUCE  
INDIVIDUAL SPOTS OF LIGHT.

---

An eye-catcher for the wall – a real highlight for the room: Wall lights are an ideal way of setting light spots in a space-saving way. With the wide range of designs and colours, there is something for every taste.

















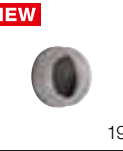
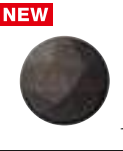
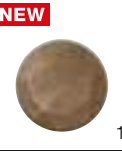













































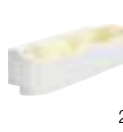



































1004733 211



1004682 + 132650 200 + 94

WALL LIGHTS

 190	 190	 191	 191	<b>NEW</b>  192	<b>NEW</b>  192	<b>NEW</b>  193	<b>NEW</b>  193
 194	 194	<b>NEW</b>  196	 197	 198	 199	 199	 199
 200	<b>NEW</b>  200	<b>NEW</b>  201	<b>NEW</b>  201	 202	 202	 204	 205
 205	 206	 206	 207	 207	<b>NEW</b>  208	 209	 210
 210	<b>NEW</b>  211	 212	 212	 213	 213	 214	 214
 215	 215	 216	<b>NEW</b>  217	<b>NEW</b>  217	 2018	 218	 219
 219	 220	 220	 220	 222	 223	 223	 223

 224	 224	 225	 226	 227	 228	 228	 229
 230	 231	 232	 232	 233	 234	 234	 235
 236	 236	 236	 238	 238	 239	 239	 240
 241	 241	 242	 243	 244	 245	 245	 246
 246	 246	 247	 248	 249	 250	 251	 251
 252	 253	 253	 254	 254	 255	 255	 256
 257	 258	 259	 260	 261	 261	 261	 262
 262	 263	 263	 264	 265	 265	 267	 268
 268	 269	 271	 271	 271	 272	 273	 273
 275	 275	 276	 276	 277			

 Other luminaires and variants can be found online at [www.slv.com](http://www.slv.com)  
You can find manufacturer's details for our recommended lamps in the chapter 'Lightbulbs', from page 844

PLASTRA  
WL, round



- Can be individually designed with colours, stickers & more

Product details

100-240V ~50/60Hz | 12V DC  
Total wattage: 7.4W  
Material: gypsum/steel



Dimensional drawing

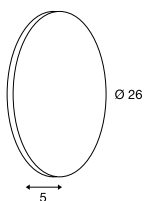

PLASTRA  
WL, square



- Can be individually designed with colours, stickers & more

Product details

100-240V ~50/60Hz | 12V DC  
Total wattage: 11W  
Material: gypsum/steel

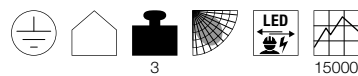

Dimensional drawing

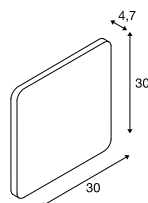

148091 190



148019 190

Variant	Item No.
400lm   3000K   CRI>80 □ matt white	148091

Variant	Item No.
400lm   3000K   CRI>80 □ matt white	148019



1000745 191

**BATO 35  
CW, PHASE**

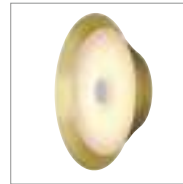
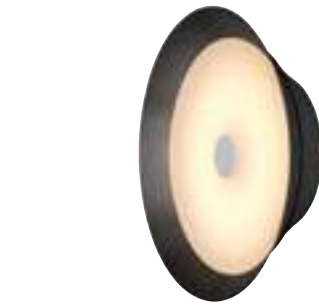

**BATO 35  
CW, E27**

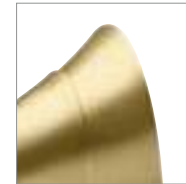

**Product details**

220-240V ~50/60Hz | 700mA  
 Total wattage: 15W  
 Material: aluminium/polymethylacrylate (PMMA)  
 Dimmable: C

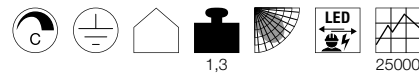

100°

**Product details**

220-240V ~50/60Hz  
 Material: aluminium/steel



**Dimensional drawing**

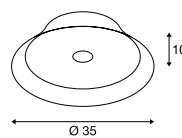

**Dimensional drawing**

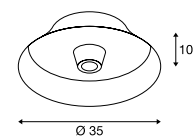

1000746 191

**Recommended lamp**

LED E27 4W 180°  
 2000-2900K 200lm  
 4kWh/1000h  
**Item No. 1003098**



LED E27 7W  
 2700K 640lm  
 7kWh/1000h  
**Item No. 1003085**



**Lamp details**

max. 60W

Variant	Item No.
850lm   2700K   CRI>80	
■ matt black	<b>1000743</b>
1050lm   2500K   CRI>80	
■ matt copper	<b>1000745</b>

Variant	Item No.
E27	
■ matt black	<b>1000746</b>
E27	
■ matt copper	<b>1000748</b>

MANA BASE  
WL, round, PHASE



MANA BASE  
Round



- Illuminated base for round shades in the MANA series
- The light colour can be selected during installation using a switch

- Non-illuminated base for round shades in the MANA series

Product details

220-240V ~50/60Hz | 350mA  
Total wattage: 15W  
Material: aluminium/polycarbonate (PC)  
Dimmable: C

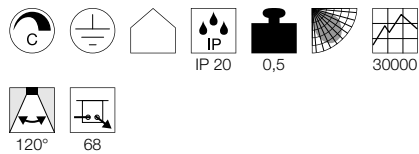

Product details

Material: aluminium/polycarbonate (PC)



Dimensional drawing

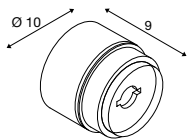

Dimensional drawing

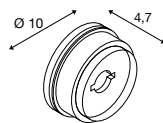

Variant	Item No.
800/820lm   2700/3000K   CRI>90	
■ anthracite	1004657

Variant	Item No.
■ anthracite	1004969

1004969 + 1004660 192 + 193







1004657 + 1004663 192 + 193

MANA 40  
Shade, round



NEW

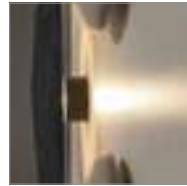

- A felt cover can contribute to acoustic attenuation

Product details

Material: felt/aluminium

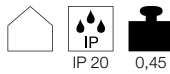

Dimensional drawing

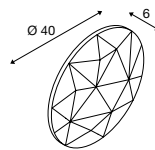

Variant	Item No.
■ matt beige	1004660
■ matt grey	1004661

MANA 60  
Shade, round



NEW



- A felt cover can contribute to acoustic attenuation

Product details

Material: felt/aluminium

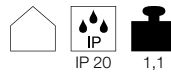

Dimensional drawing

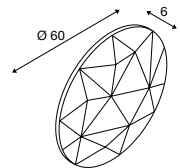

Variant	Item No.
■ matt beige	1004662
■ matt grey	1004663

ONE 40  
WL, DALI



- The light colour can be selected during installation using a switch

Product details

220-240V ~50/60Hz | 350mA  
Total wattage: 14W  
Material: aluminium/steel  
Dimmable: Dali

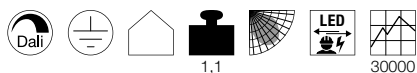

Dimensional drawing

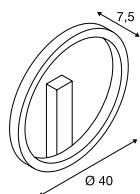

Variant	Item No.
720/770lm   3000/4000K   CRI>80	
■ matt black	1002915
720/770lm   3000/4000K   CRI>80	
□ matt white	1002917

ONE 60  
WL, DALI

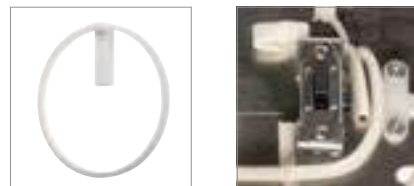

- The light colour can be selected during installation using a switch

Product details

220-240V ~50/60Hz | 600mA  
Total wattage: 25W  
Material: aluminium/steel  
Dimmable: Dali



Dimensional drawing

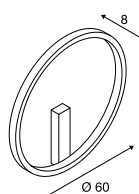

Variant	Item No.
1400/1500lm   3000/4000K   CRI>80	
■ matt black	1002918
1400/1500lm   3000/4000K   CRI>80	
□ matt white	1002919



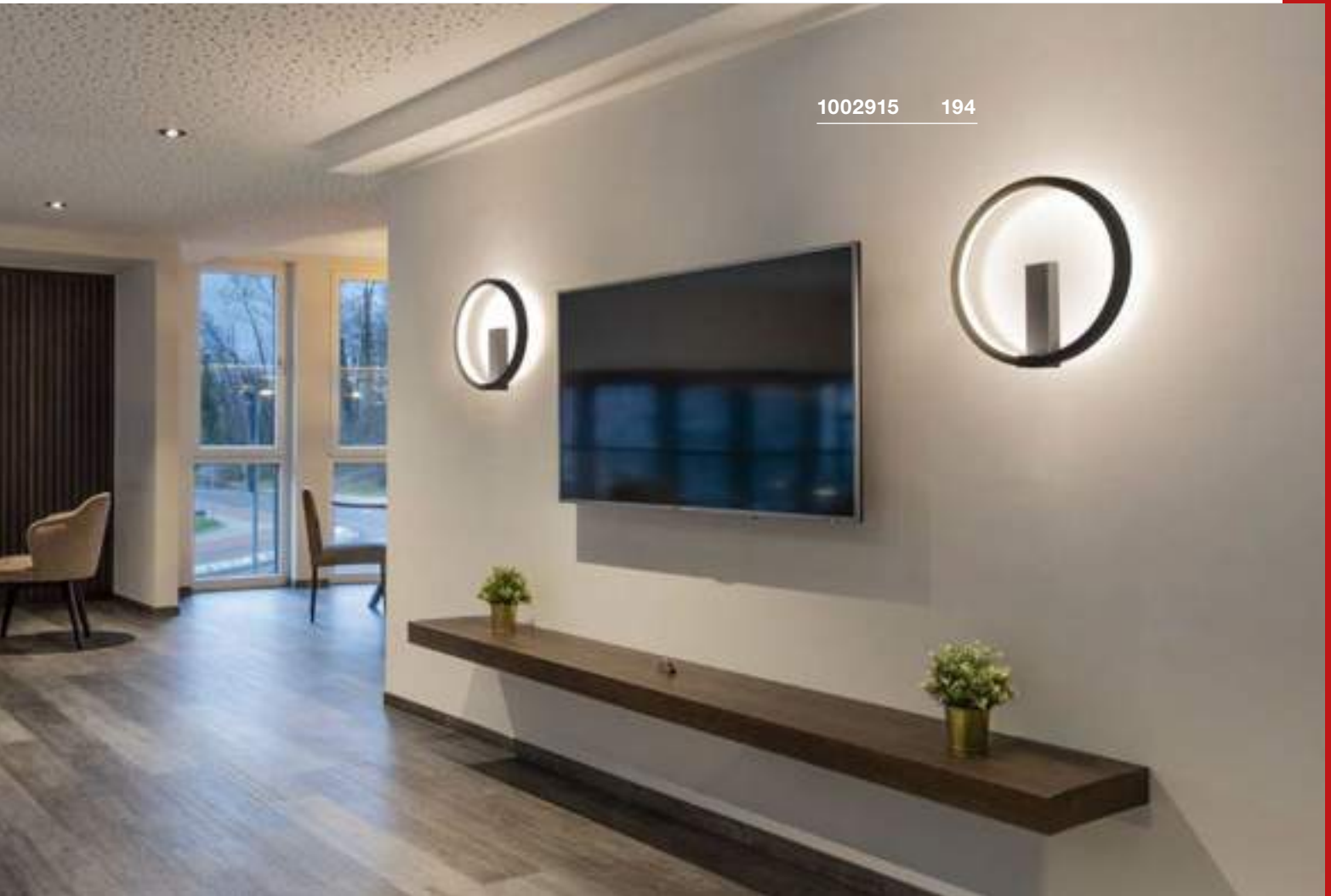

1002915 194



1002919 195

FITU CUBE  
WL, E27



NEW



SOCKET  
INSIDE



Product details

220-240V ~50/60Hz  
Material: steel

1004739 196

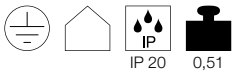

Dimensional drawing

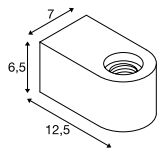

Tip

Lights may only be mounted with the lightbulb pointing upwards.

Recommended lamp

LED E27 8W  
2000-2900K 300lm  
8kWh/1000h  
Item No. 1003096



LED E27 8W 350°  
2200K 250lm  
8kWh/1000h  
Item No. 1003100



Lamp details

max. 20W LED E27  
Diameter: 12.5cm max.

Variant	Item No.
E27	
■ matt black	1004738
E27	
□ matt white	1004739





155752 197



155752 197

## LISENNE WL, E27



SOCKET  
INSIDE



- Basalt stone & smoked glass

### Product details

220-240V ~50/60Hz  
Material: basalt/glass

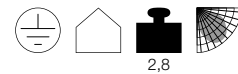

### Dimensional drawing

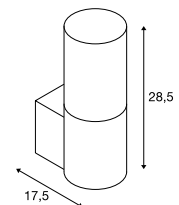

### Recommended lamp

LED E27 7.1W 330°  
2700K 806lm  
8kWh/1000h

Item No. 1001756



LED E27 9W 240°  
3000K 810lm  
10kWh/1000h

Item No. 1001031



### Lamp details

max. 23 W  
Diameter: 5.9 cm max. L: 15 cm max.

Variant	Item No.
E27 ■ grey/mirrored brown	155752

ANDREAS  
WL, QT-DE12

SOCKET  
INSIDE

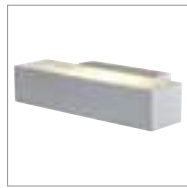

Product details

220-240V ~50/60Hz  
Material: aluminium/steel



0,56

100°

Dimensional drawing

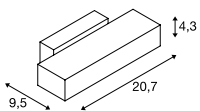

Recommended lamp

LED R7s 118mm 14W  
3000K 2000lm  
14kWh/1000h  
Item No. 1002135



Lamp details

max. 80W

Variant	Item No.
R7s 118mm	
■ black	1002927
R7s 118mm	
□ white	1002925
R7s 118mm	
■ grey	1002926

1002926 198

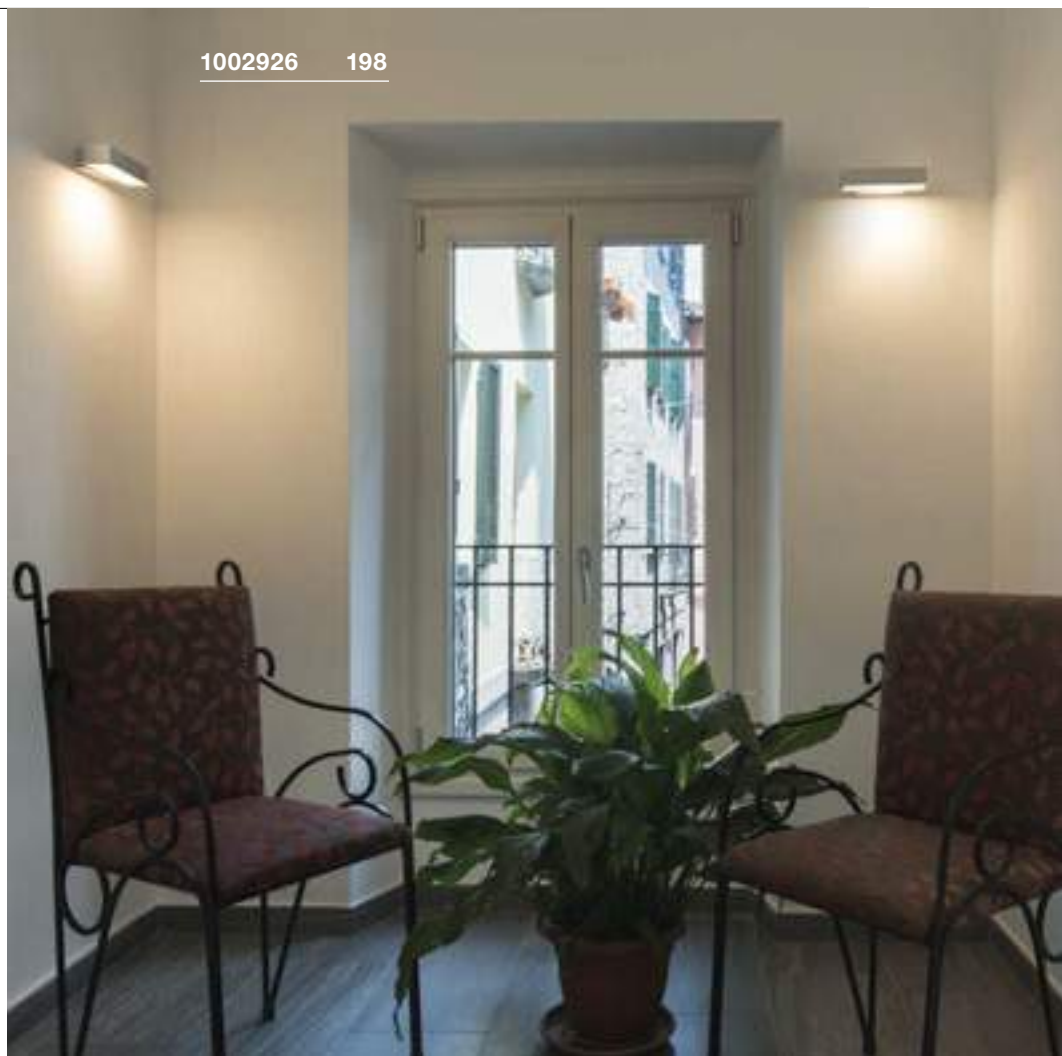

151591 199



**DENA 30**  
WL, E14

SOCKET  
INSIDE



**PURISA**  
WL, E27

SOCKET  
INSIDE

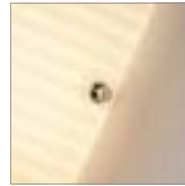

**BASKET**  
WL, E27

SOCKET  
INSIDE

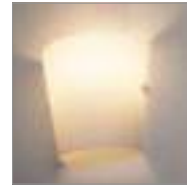

• High-quality, satin-finish glass

**Product details**

230V -50Hz  
Material: aluminium/glass



0,73

**Dimensional drawing**

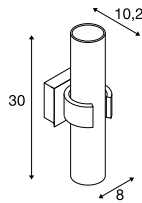

**Product details**

220-240V ~50/60Hz  
Material: steel/glass



0,98

**Dimensional drawing**

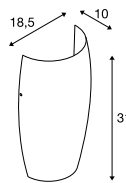

**Product details**

230V -50Hz  
Material: aluminium/glass



1,14

**Dimensional drawing**

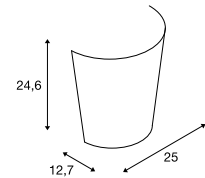

**Recommended lamp**

LED E14 4,5W 280°  
2700K 470lm  
5kWh/1000h  
Item No. 1002128



LED E14 6,5W 280°  
2700K 480lm  
7kWh/1000h  
Item No. 560372



**Lamp details**

2x max. 40W C35  
Diameter: 5 cm max. L: 9.6 cm max.

Variant	Item No.
white/aluminium	147529

**Recommended lamp**

LED E27 9.1W 240°  
2700K 760lm  
10kWh/1000h  
Item No. 560402



LED E27 7W  
2700K 810lm  
7kWh/1000h  
Item No. 1003090



**Lamp details**

max. 40W  
Diameter: 8 cm max. L: 15 cm max.

Variant	Item No.
white	1002993

**Recommended lamp**

LED E27 14.5W 200°  
2700K 1521lm  
15kWh/1000h  
Item No. 560422



LED E27 9W 240°  
4000K 850lm  
9kWh/1000h  
Item No. 1002827



**Lamp details**

max. 60W  
Diameter: 5.2 cm max. L: 15.2 cm max

Variant	Item No.
white	151591

FITU  
WL, E27



FITU  
Wall bracket



SOCKET  
INSIDE



NEW

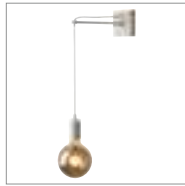

• Wall bracket for FITU pendant lights

Product details

220-240V ~50/60Hz  
Material: aluminium/steel



Product details

Material: steel

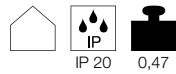

Dimensional drawing

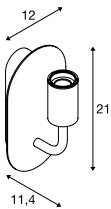

Dimensional drawing

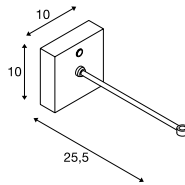

Tip

You can find pendant lights in the current BIG WHITE catalogue from page 94

Recommended lamp

LED E27 5W 330°  
2000K 500lm  
5kWh/1000h  
Item No. 560741



LED E27 7.1W 330°  
2700K 806lm  
8kWh/1000h  
Item No. 1001756



Lamp details

max. 24 W

Variant	Item No.
E27	
□ white	1002147
■ black	1002148
E27	
■ gold	1002149

Variant	Item No.
■ matt black	1004682
□ matt white	1004683

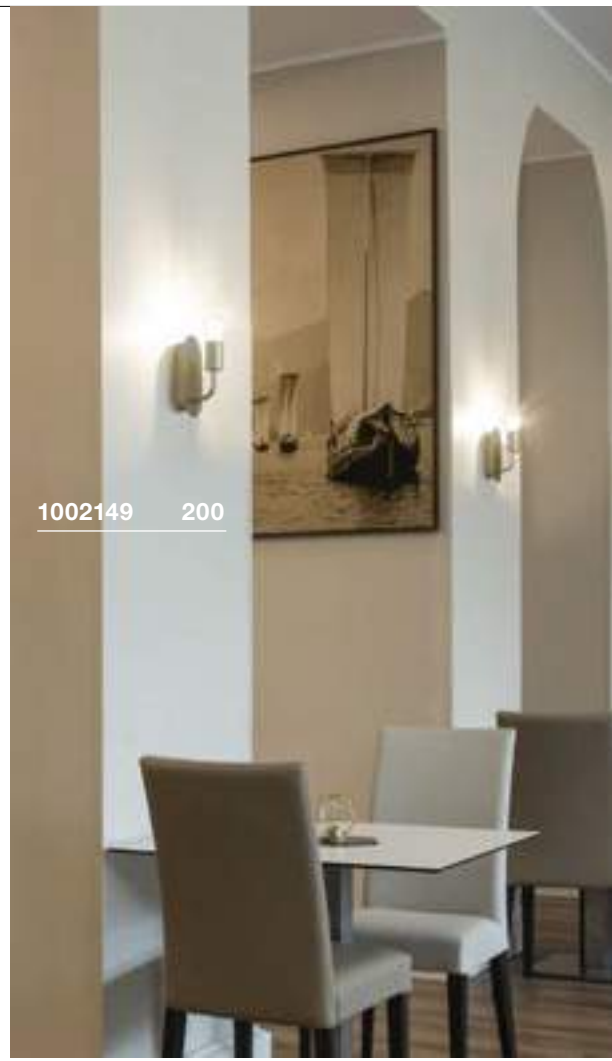

1002149 200



1004683 + 156141 200 + 104



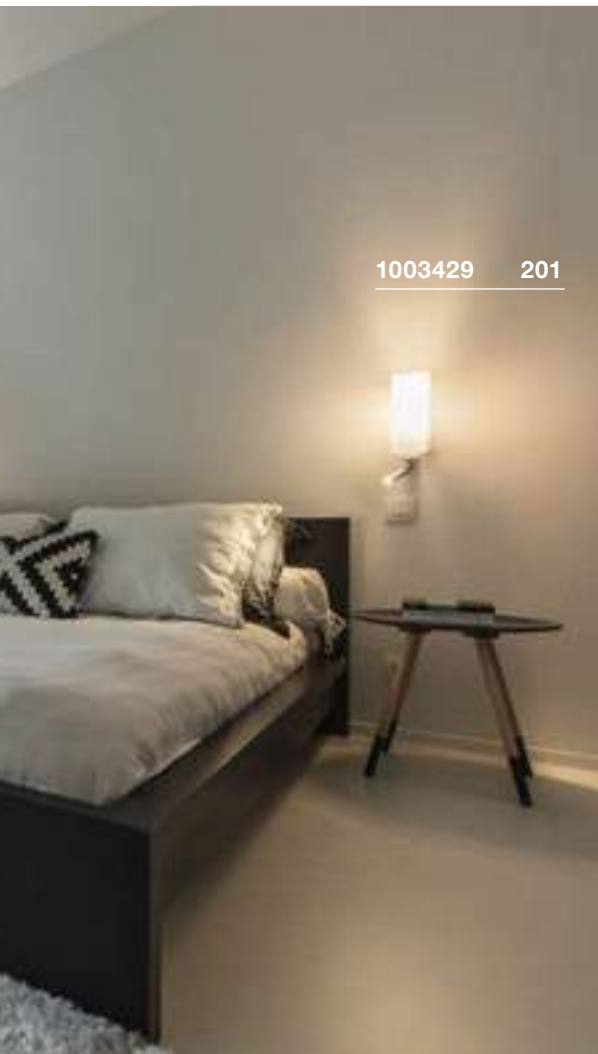

1003429 201



1003430 201

QUADRASS SPOT  
WL, E27



• Lightbulbs available separately

Product details

220-240V ~50/60Hz | 700mA  
Material: steel/glass

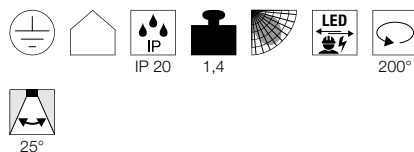

Dimensional drawing

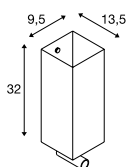

Recommended lamp

LED E27 9.1W 240°  
2700K 760lm  
10kWh/1000h  
Item No. 560402



LED E27 7W  
2700K 810lm  
7kWh/1000h  
Item No. 1003090



Lamp details

max. 40W  
Diameter: 6.5 cm max. L: 18 cm max.

Variant	Item No.
E27   Spot: 200lm   3000K   CRI>80	
■ matt black/white	1003428
E27   Spot: 200lm   3000K   CRI>80	
□ matt white/white	1003429

QUADRASS  
WL, E27



Product details

220-240V ~50/60Hz  
Material: steel/glass

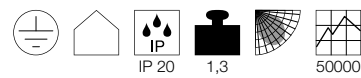

Dimensional drawing

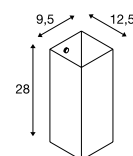

Recommended lamp

LED E27 14.5W 200°  
2700K 1521lm  
15kWh/1000h  
Item No. 560422



LED E27 7W  
2700K 810lm  
7kWh/1000h  
Item No. 1003090



Lamp details

max. 40W  
Diameter: 6.5 cm max. L: 18 cm max.

Variant	Item No.
E27	
■ matt black/white	1003430
E27	
□ matt white/white	1003431

FENDA  
WL, Base, E27



SOCKET  
INSIDE



Product details

230V ~50/60Hz  
Material: steel/plastic



Dimensional drawing

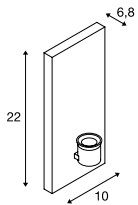

Recommended lamp

LED E27 9W 240°  
3000K 810lm  
10kWh/1000h  
Item No. 1001031



LED E27 9W 240°  
4000K 850lm  
9kWh/1000h  
Item No. 1002827



Lamp details

max. 40W  
Diameter: 5 cm max. L: 20 cm max.

Variant	Item No.
E27	
white	1001272

FENDA  
Half shade

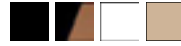

Product details

Material: textile/steel



Dimensional drawing

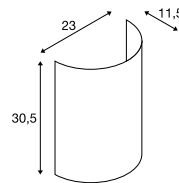

Tip

max. 40W

Variant	Item No.
black	1001273
black/copper	1001274
white	1001275
beige	1001276





1001272 + 1001273    202

MANA  
WL, Base, PHASE



- Premium LED with CRI>90
- Dim to Warm

Product details

220-240V ~50/60Hz | 350mA  
 Total wattage: 8W  
 Material: aluminium/steel  
 Dimmable: C



Dimensional drawing

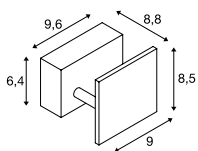

1000613 + 1000618 204 + 205



1000613 + 1000616 204 + 205

Variant	Item No.
320lm   2000-3000K   CRI>90	
□ white	1000613



MANA  
Shade



MANA  
Shade



- Can be individually designed with colours, stickers & more

Product details

Material: gypsum/steel



Dimensional drawing

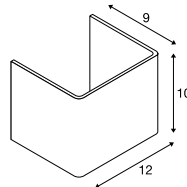

Tip

suitable only with 1000613

Dimensional drawing

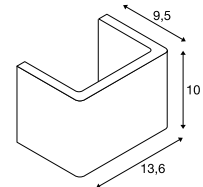

Tip

suitable only with 1000613

Variant	Item No.
Wood   0.11 kg	
■ grey/brown	1000616
Aluminium   0.29 kg	
□ white	1000618
Aluminium   0.29 kg	
□ aluminium	1000619

Variant	Item No.
□ matt white	1000824

MANA  
WL, Base, PHASE



- Premium LED with CRI>90
- Dim to Warm

Product details

220-240V ~50/60Hz | 350mA  
Total wattage: 15W  
Material: aluminium/steel  
Dimmable: C



Dimensional drawing

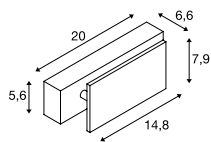

MANA  
WL, Base



- Premium LED with CRI>90
- With adjustable reading light; lightbulb with separate switch

Product details

100-240V ~50/60Hz | 320mA/500mA  
Total wattage: 11W  
Material: aluminium/steel



Dimensional drawing

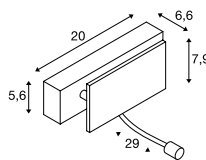

1000614 + 1000621 206 + 207



1000615 + 1000624 206 + 207

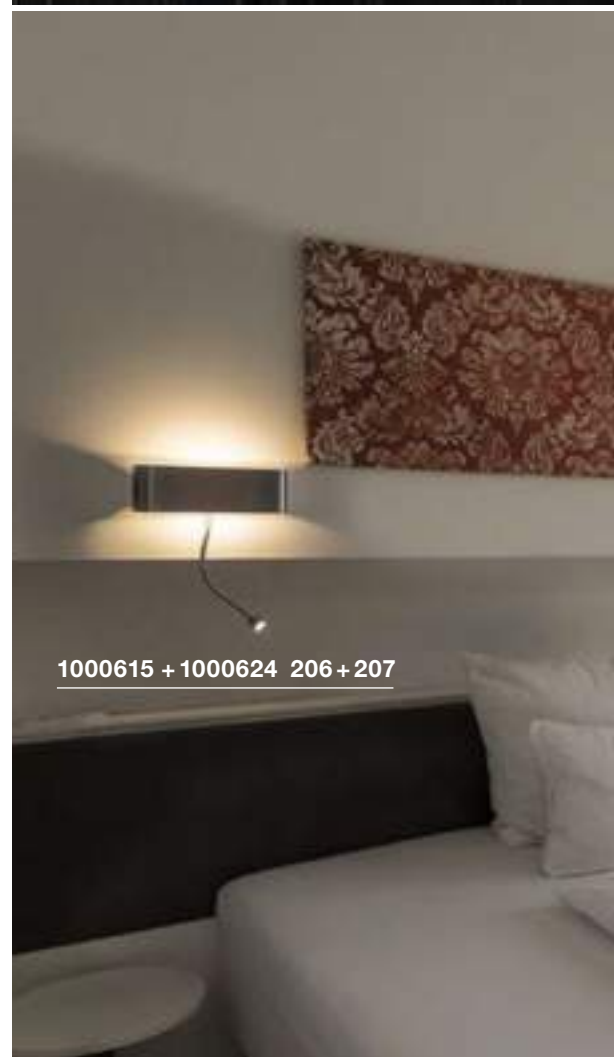

Variant	Item No.
700lm   2000-3000K   CRI>90 □ white	1000614

Variant	Item No.
Indirect: 490lm   3000K   CRI>90 Spot: 80lm   3000K   CRI>90 ■ white/chrome	1000615



1000614 + 1000825 206 + 207

MANA Shade



MANA Shade

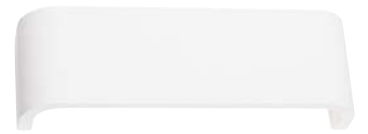

- Can be individually designed with colours, stickers & more

Product details

Material: gypsum/steel



Dimensional drawing

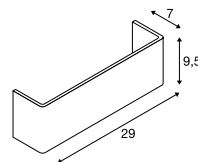

Tip

suitable only with 1000614/1000615

Dimensional drawing

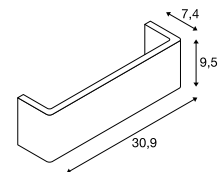

Tip

suitable only with 1000614/1000615

Variant	Item No.
Wood   0.16 kg	
■ grey/brown	1000621
Aluminium   0.39 kg	
□ white	1000623
Aluminium   0.39 kg	
■ aluminium	1000624

Variant	Item No.
□ matt white	1000825

PLASTRA  
WL, hemisphere



NEW

SOCKET  
INSIDE



1004732 208



Product details

220-240V ~50/60Hz  
Material: gypsum/steel

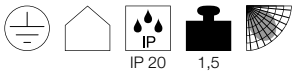

Dimensional drawing

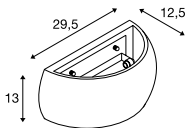

Recommended lamp

LED R7s 118mm 14W  
3000K 2000lm  
14kWh/1000h  
Item No. 1002135



Variant	Item No.
R7s 118mm   QT-DE12 □ matt white	1004732







1002238 209

**PLASTRA**  
WL, rectangular, QT-DE12**SOCKET**  
**INSIDE**

- Can be individually designed with colours, stickers & more

**Product details**220-240V ~50/60Hz  
Material: gypsum/steel

1,6

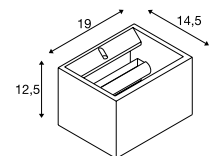
**Dimensional drawing****Recommended lamp**LED R7s 118mm 14W  
3000K 2000lm  
14kWh/1000h  
Item No. 1002135**Lamp details**

max. 20W

Variant	Item No.
R7s 118mm □ matt white	1002238

SOLID CUBE  
WL, QT14

SOCKET  
INSIDE



PLASTRA  
WL, Cube, QT14



SOCKET  
INSIDE

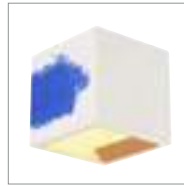
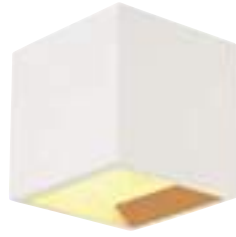

- Can be individually designed with colours, stickers & more

Product details

230V -50Hz  
Material: concrete



1,1

Product details

230V -50Hz  
Material: gypsum/steel



1

Dimensional drawing

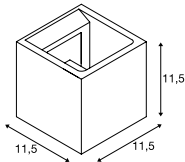

Dimensional drawing

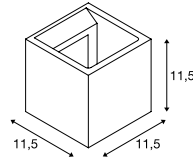

Recommended lamp

G9 2.5W  
2700K 180lm  
3kWh/1000h  
Item No. 560302



Recommended lamp

G9 2.5W  
2700K 180lm  
3kWh/1000h  
Item No. 560302



Lamp details

max. 25W QT14

Lamp details

max. 42W QT14

Variant	Item No.
G9   QT14	
■ grey	1000910
■ black	1000911

Variant	Item No.
G9   QT14	
□ matt white	148018



1000911 210



148018 210



1004733 211

## PLASTRA

WL, cubes

NEW

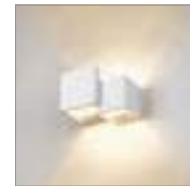
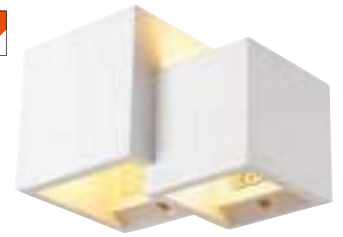
SOCKET  
INSIDE

- Can be individually designed with colours, stickers & more

### Product details

220-240V ~50/60Hz  
Material: gypsum/steel



IP 20



1,36



### Dimensional drawing

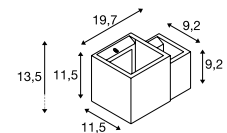

### Recommended lamp

G9 2,5W  
2700K 180lm  
3kWh/1000h  
Item No. 560302



### Lamp details

2x 15W QT14  
optional: LED G9

Variant	Item No.
G9   QT14 □ matt white	1004733

LOGS IN  
WL, PHASE



- Premium LED with CRI>90
- Dim to Warm

Product details

220-240V ~50/60Hz | 250mA  
Total wattage: 12W  
Material: aluminium  
Dimmable: C, L



Dimensional drawing

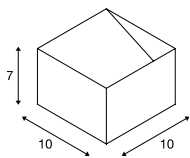

LOGS IN  
WL



Product details

100-240V ~50/60Hz | 500mA  
Total wattage: 6.9W  
Material: aluminium



Dimensional drawing

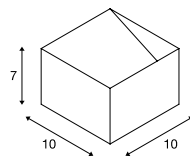

1000639 212



151320 212



Variant	Item No.
290lm   2000-3000K   CRI>90	
black/gold	1000638
490lm   2000-3000K   CRI>90	
white	1000639
490lm   2000-3000K   CRI>90	
aluminium/white	1000640

Variant	Item No.
390lm   3000K   CRI>90	
black/gold	151320
440lm   3000K   CRI>90	
white	151321
440lm   3000K   CRI>90	
aluminium/white	151325



1002843 213

LOGS IN L  
WL, PHASE



- Premium LED with CRI>90
- Dim to Warm

Product details

220-240V ~50/60Hz | 500mA  
Total wattage: 19W  
Material: aluminium  
Dimmable: C, L



Dimensional drawing

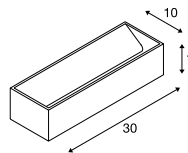

1002928 213

LOGS IN L  
WL, PHASE



- Premium LED with CRI>90

Product details

220-240V ~50/60Hz | 500mA  
Total wattage: 17W  
Material: aluminium  
Dimmable: C, L



Dimensional drawing

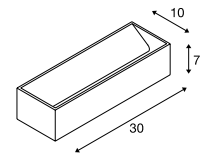

Variant	Item No.
1100lm   2000-3000K   CRI>90	
■ black/gold	1002928
1500lm   2000-3000K   CRI>90	
□ white	1002929
1500lm   2000-3000K   CRI>90	
■ aluminium/white	1002930

Variant	Item No.
1100lm   3000K   CRI>90	
■ black/gold	1002842
1400lm   3000K   CRI>90	
□ white	1002844
1400lm   3000K   CRI>90	
■ aluminium/white	1002843

QUAD UP/DOWN 12  
WL



QUAD UP/DOWN 15  
WL

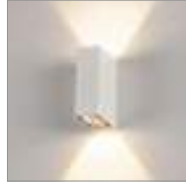

Product details

200-240V ~50/60Hz | 700mA  
Total wattage: 6.8W  
Material: aluminium/glass

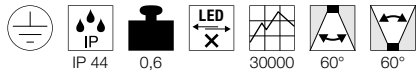

Product details

100-277V ~50/60Hz | 350mA  
Total wattage: 8.6W  
Material: aluminium/glass



Dimensional drawing

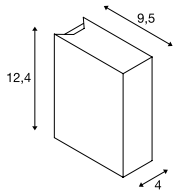

Dimensional drawing

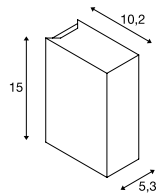

Variant	Item No.
175lm   3000K   CRI>80 white	232471
140lm   3000K   CRI>80 anthracite	232475

Variant	Item No.
Up: 290lm   3000K   CRI>80 Down: 290lm   3000K   CRI>80 white	232441
Up: 260lm   3000K   CRI>80 Down: 260lm   3000K   CRI>80 anthracite	232445



232471 214

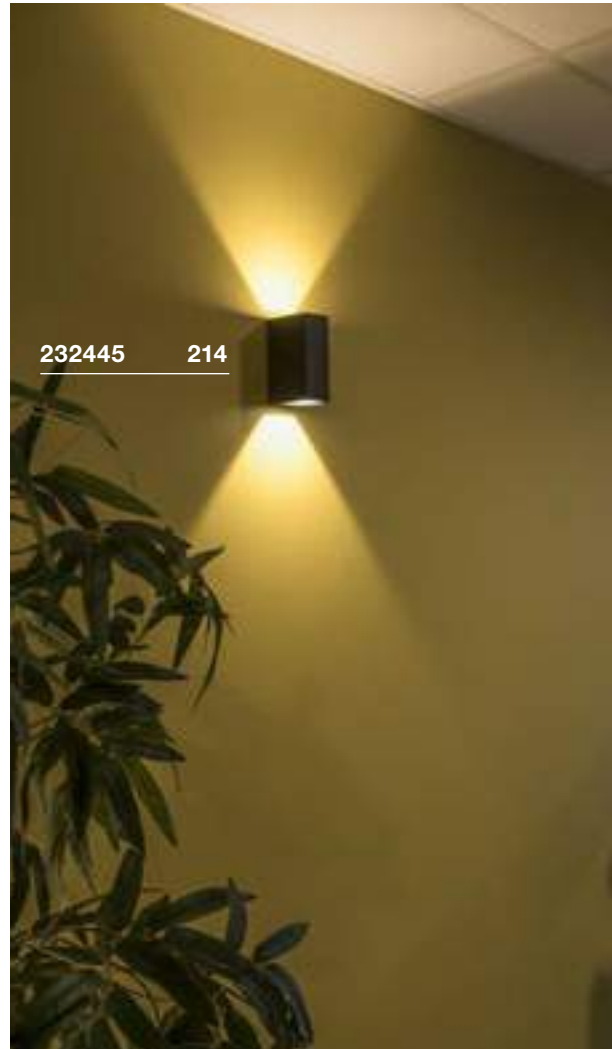

232445 214



148010 215



148015 215

PLASTRA SLOT  
WL, E14



SOCKET  
INSIDE

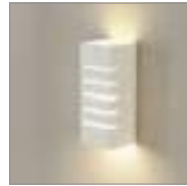

- Can be individually designed with colours, stickers & more

Product details

230V -50Hz  
Material: gypsum/steel



0,81

Dimensional drawing

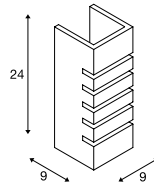

Recommended lamp

LED E14 6,5W 280°  
2700K 480lm  
7kWh/1000h  
Item No. 560372



Lamp details

max. 40W C35

Variant	Item No.
E14   C35	
<input type="checkbox"/> matt white	148010

PLASTRA  
WL, QPAR51



SOCKET  
INSIDE

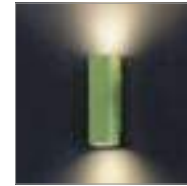

- Can be individually designed with colours, stickers & more

Product details

220-240V ~50/60Hz  
Material: gypsum/steel

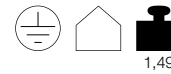

1,49

Dimensional drawing

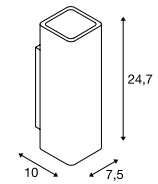

Recommended lamp

LED GU10 6W 36°  
3000K 460lm  
6kWh/1000h  
Item No. 1005079



LED GU10 4W 36°  
2700K 300lm  
4kWh/1000h  
Item No. 1004972



Lamp details

2x max. 35W QPAR51

Variant	Item No.
GU10   QPAR51	
<input type="checkbox"/> matt white	148015

THEO UP/DOWN  
WL, QPAR51



SOCKET  
INSIDE



Product details

230V -50Hz  
Material: aluminium



Dimensional drawing

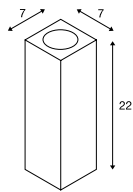

Recommended lamp

LED GU10 5.5W 38°  
2700K 400lm  
6kWh/1000h  
Item No. 1001030



LED GU10 4W 36°  
3000K 300lm  
4kWh/1000h  
Item No. 1004973



Lamp details

2x max. 50W QPAR51

Variant	Item No.
GU10   QPAR51 white	1000327
GU10   QPAR51 grey	1000328
GU10   QPAR51 matt aluminium	1000329
GU10   QPAR51 anthracite	1000330

1000330 + 1000327 216







1004740 217



1004743 217

DIRETO 60  
WL, PHASE



- The light colour can be selected during installation using a switch

Product details

220-240V ~50/60Hz | 500mA  
Total wattage: 14W  
Material: aluminium  
Dimmable: C

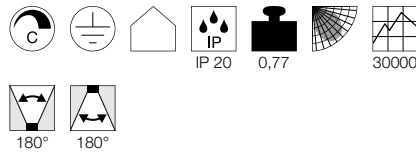

Dimensional drawing

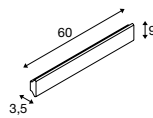

Variant	Item No.
Up: 590/625lm   2700/3000K   CRI>90 Down: 590/625lm   2700/3000K   CRI>90 ■ matt black	1004740
Up: 590/625lm   2700/3000K   CRI>90 Down: 590/625lm   2700/3000K   CRI>90 □ matt white	1004741

DIRETO 90  
WL, PHASE

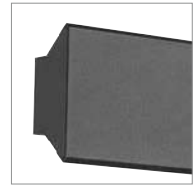

- The light colour can be selected during installation using a switch

Product details

220-240V ~50/60Hz | 500mA  
Total wattage: 20W  
Material: aluminium  
Dimmable: C

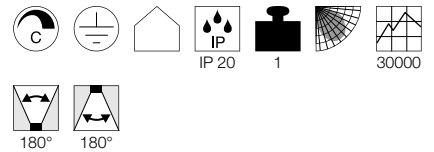

Dimensional drawing

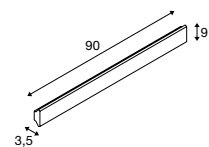

Variant	Item No.
Up: 840/880lm   2700/3000K   CRI>90 Down: 840/880lm   2700/3000K   CRI>90 ■ matt black	1004742
Up: 840/880lm   2700/3000K   CRI>90 Down: 840/880lm   2700/3000K   CRI>90 □ matt white	1004743

**CHROMBO**  
WL, PHASE



**TANI**  
WL, QT-DE12



**Product details**

220-240V ~50/60Hz  
Total wattage: 9.7W  
Material: steel/glass  
Dimmable: C, L



**Dimensional drawing**

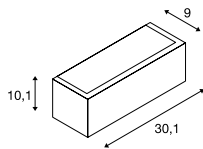

**Product details**

230V -50Hz  
Material: aluminium/glass



**Dimensional drawing**

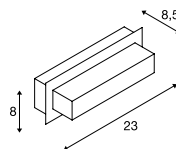

**Recommended lamp**

LED R7s 118mm 14W  
3000K 2000lm  
14kWh/1000h  
Item No. 1002135



**Lamp details**

max. 200W QT-DE12

Variant	Item No.
480lm   3000K   CRI>80 white	1003316
480lm   3000K   CRI>80 matt grey	1003317

Variant	Item No.
R7s 118mm   QT-DE12 matt aluminium	147566



1003317 218



147566 218



149512 219



149511 219

WL 149  
WL, QT-DE12

SOCKET  
INSIDE



WL 149  
WL

LED  
INSIDE

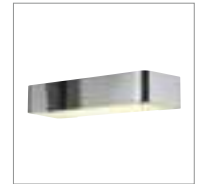

Product details

230V -50Hz  
Material: steel/glass



Product details

220-240V ~50/60Hz | 500mA  
Total wattage: 16W  
Material: steel/glass



Dimensional drawing

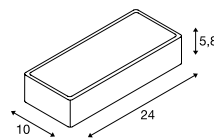

Dimensional drawing

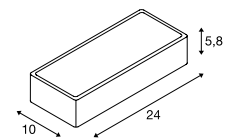

Recommended lamp

R7s 78mm 55W 330°  
3000K 530lm  
6kWh/1000h  
Item No. 560332



Lamp details

max. 60W QT-DE12

Variant	Item No.
R7s 78mm   QT-DE12	
□ white	149471
R7s 78mm   QT-DE12	
■ chrome	149472

Variant	Item No.
1060lm   3000K   CRI>80	
□ white	149511
1060lm   3000K   CRI>80	
■ chrome	149512

SEDO 7  
WL

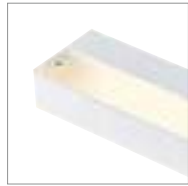

SEDO 14  
WL



SEDO 21  
WL



Product details

220-240V ~50/60Hz | 350mA  
Total wattage: 11.5W  
Material: aluminium/glass

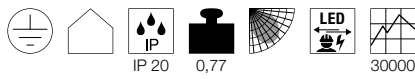

Product details

220-240V ~50/60Hz | 500mA  
Total wattage: 16W  
Material: aluminium/glass

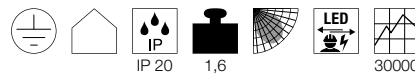

Product details

220-240V ~50/60Hz | 700mA  
Total wattage: 30W  
Material: aluminium/glass



Dimensional drawing

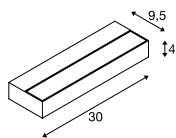

Dimensional drawing

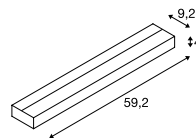

Dimensional drawing

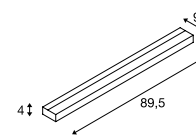

Variant	Item No.
1020lm   3000K   CRI>80	
white	1002962
1020lm   3000K   CRI>80	
aluminium	1002964

Variant	Item No.
1300lm   3000K   CRI>80	
white	151781
1300lm   3000K   CRI>80	
aluminium	151786

Variant	Item No.
250lm · 3000K · CRI>80	
white	151791
250lm · 3000K · CRI>80	
aluminium	151796



1002964    220



151796    220

ASSO 70  
WL



Product details

100-240V ~50/60Hz | 500mA  
Total wattage: 7.6W  
Material: aluminium/steel

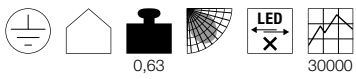

Dimensional drawing

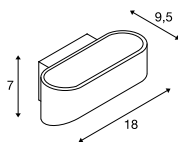

1000636 223



1000635 223

Variant	Item No.
350lm   3000K   CRI>80	
white	151311
350lm   3000K   CRI>80	
aluminium/white	151315

ASSO 300  
WL

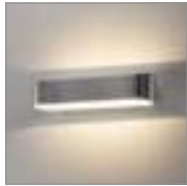

Product details

220-240V ~50/60Hz | 500mA  
Total wattage: 12W  
Material: aluminium/steel



Dimensional drawing

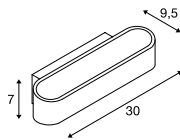

Variant	Item No.
700lm · 3000K · CRI>80	
white	151271
700lm · 3000K · CRI>80	
aluminium/white	151275

ASSO 300  
WL, PHASE



Product details

220-240V ~50/60Hz | 500mA  
Total wattage: 22W  
Material: aluminium/steel  
Dimmable: C, L



Dimensional drawing

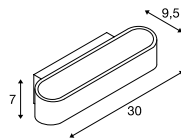

Variant	Item No.
1040lm   2000-3000K   CRI>90	
white	1000634
1040lm   2000-3000K   CRI>90	
aluminium/white	1000635

ASSO  
WL, PHASE



Product details

220-240V ~50/60Hz | 250mA  
Total wattage: 12W  
Material: aluminium/steel  
Dimmable: C



Dimensional drawing

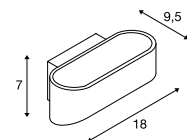

Variant	Item No.
530lm   2000-3000K   CRI>90	
white	1000636
530lm   2000-3000K   CRI>90	
aluminium/white	1000637

OSSA 180  
WL, QT-DE12

SOCKET  
INSIDE



OSSA 300  
WL, QT-DE12

SOCKET  
INSIDE



Product details

230V -50Hz  
Material: aluminium/steel



0,65

Product details

230V -50Hz  
Material: aluminium/steel



0,85

Dimensional drawing

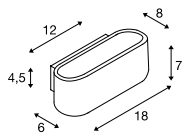

Dimensional drawing

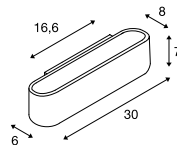

Recommended lamp

R7s 78mm 55W 330°  
3000K 530lm  
6kWh/1000h  
Item No. 560332



Recommended lamp

LED R7s 118mm 14W  
3000K 2000lm  
14kWh/1000h  
Item No. 1002135



Lamp details

max. 100W QT-DE12

Lamp details

max. 120W QT-DE12

Variant	Item No.
R7s 78mm   QT-DE12	
■ black	151450
R7s 78mm   QT-DE12	
□ white	151451
R7s 78mm   QT-DE12	
▒ aluminium	151456

Variant	Item No.
R7s 118mm   QT-DE12	
■ black	151410
R7s 118mm   QT-DE12	
□ white	151411
R7s 118mm   QT-DE12	
▒ aluminium	151416





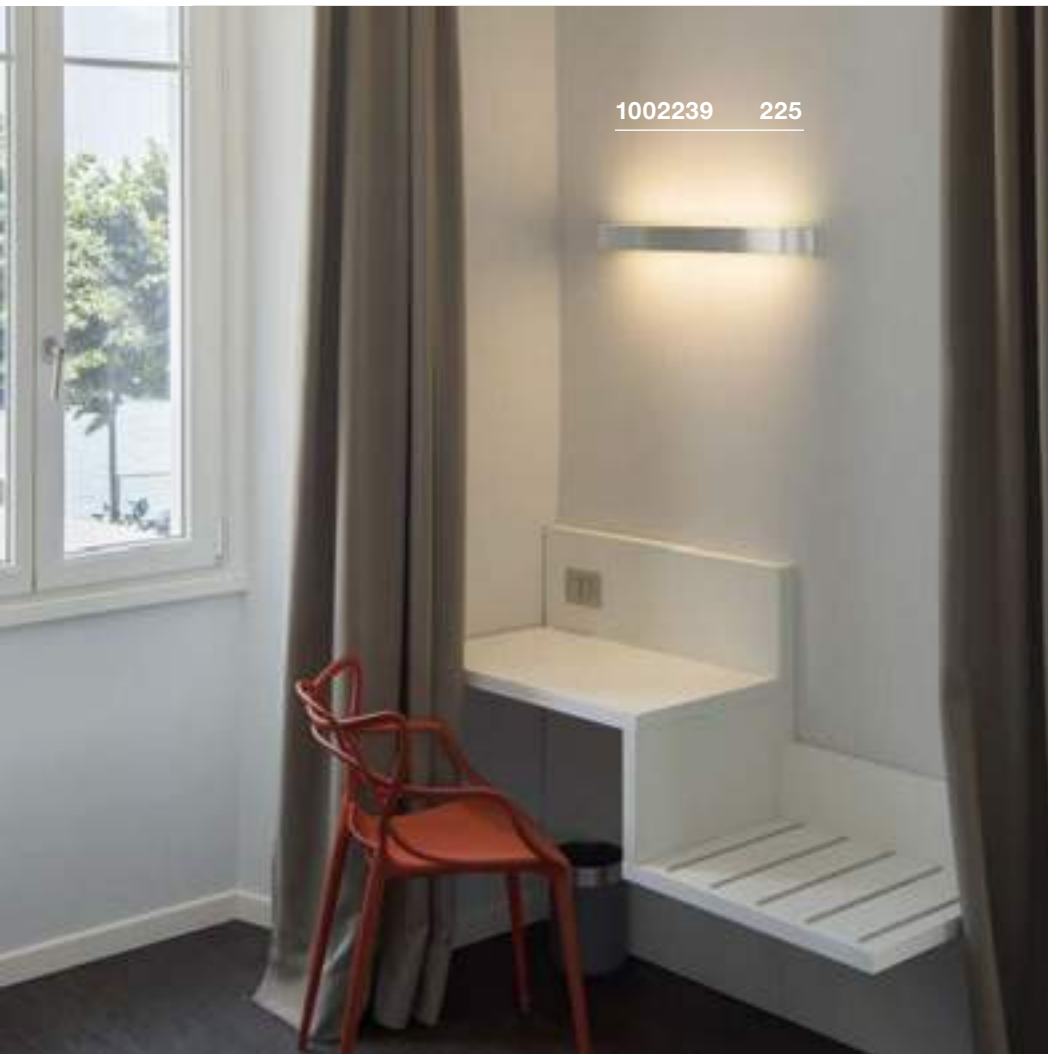

1002239 225

ARLINA 60/130  
WL

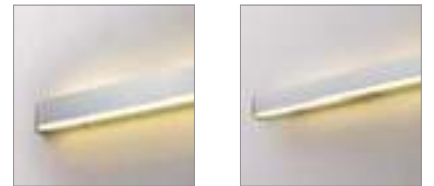
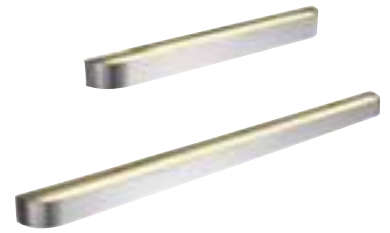

Product details

220-240V ~50/60Hz | 500mA  
Material: aluminium/glass  
Product dimensions: W: 6.8 cm H: 6 cm



Dimensional drawing

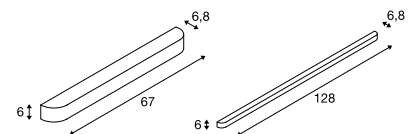

1002240 225

Variant	Item No.
1400lm   3000K   CRI>80 20W   L: 67 cm   2.2 kg	1002239
aluminium	
2400lm   3000K   CRI>80 28W   L: 128 cm   3.9 kg	1002240
aluminium	

NEW FLAT  
WL, RGB-W

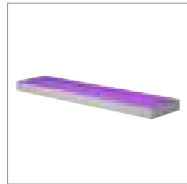
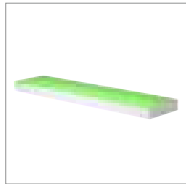

Product details

220-240V ~50/60Hz | 24V  
Total wattage: 11.3W  
Material: aluminium/acrylic



Dimensional drawing

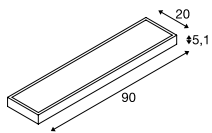

1003023 226



Variant	Item No.
Up: RGB-W (300lm   3000K   CRI>80) Down: RGB-W (280lm   3000K   CRI>80)	
<input type="checkbox"/> matt white	1003022
Up: RGB-W (300lm   3000K   CRI>80) Down: RGB-W (280lm   3000K   CRI>80)	
<input type="checkbox"/> matt aluminium	1003023



PLASTRA  
WL, curve, PHASE



- High-voltage LED
- Can be individually designed with colours, stickers & more

Product details

230V -50Hz  
Total wattage: 19W  
Material: gypsum/glass  
Dimmable: C, L

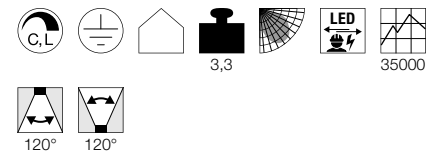

Dimensional drawing

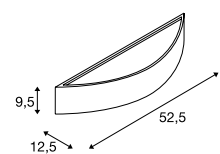

148062 227

Variant	Item No.
Up: 520lm   3000K   CRI>80 Down: 520lm   3000K   CRI>80 <input type="checkbox"/> matt white	148062

CARISO  
WL, PHASE

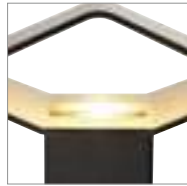

- The various different inner illumination colours lead to different light colours

Product details

220-240V ~50/60Hz | 500mA  
Total wattage: 11W  
Material: aluminium/steel  
Dimmable: C, L



Dimensional drawing

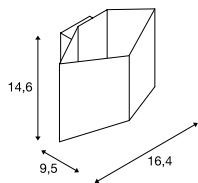

CARISO  
WL, PHASE



- Premium LED with CRI>90
- The various different inner illumination colours lead to different light colours

Product details

220-240V ~50/60Hz | 500mA  
Total wattage: 22W  
Material: aluminium/steel  
Dimmable: C, L

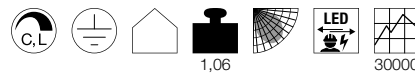

Dimensional drawing

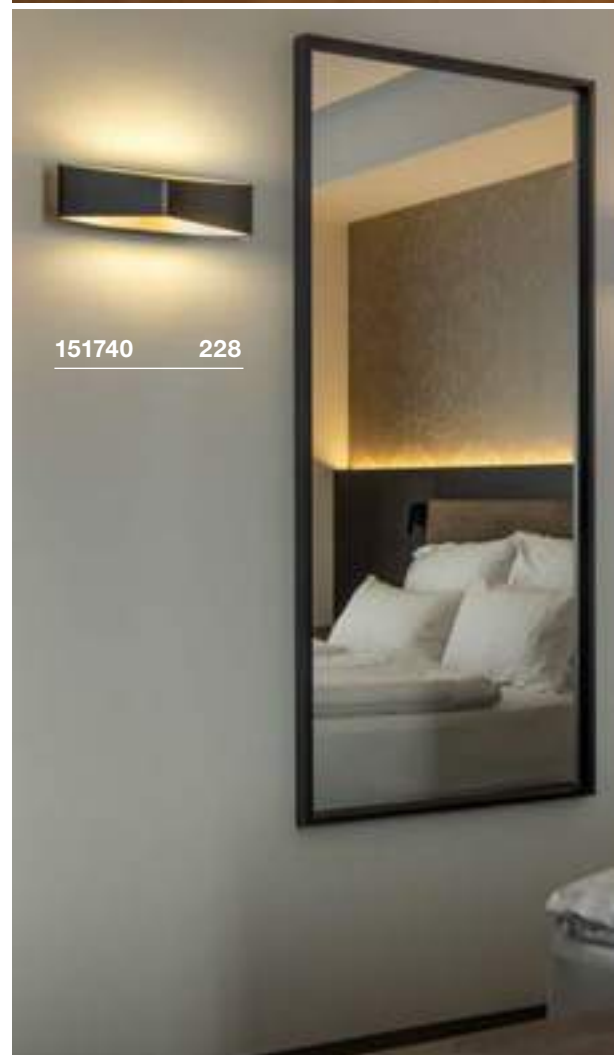
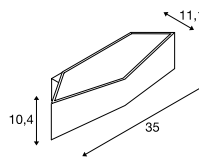

Variant	Item No.
200lm   2700K   CRI>80	
black/gold	151710
390lm   3000K   CRI>80	
white	151711

Variant	Item No.
500lm   1700-2700K   CRI>90	
black/gold	151740
900lm   2000-3000K   CRI>90	
white	151741



151610 229

LED SAIL  
WLLED  
INSIDE

## Product details

100-240V ~50/60Hz | 700mA  
Total wattage: 6W  
Material: aluminium/steel



0,94



30000

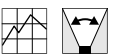

60°



60°

## Dimensional drawing

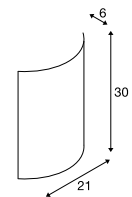

## Variant

## Item No.

Up: 85lm | 3000K | CRI&gt;80

Down: 85lm | 3000K | CRI&gt;80

■ glossy black

151610

Up: 520lm | 3000K | CRI&gt;80

Down: 120lm | 3000K | CRI&gt;80

□ glossy white

151611

PLASTRA 104  
WL, QT14



148016 230



- Can be individually designed with colours, stickers & more

Product details

230V -50Hz  
Material: gypsum/steel



Dimensional drawing

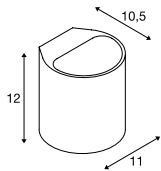

Recommended lamp

G9 2.5W  
2700K 180lm  
3kWh/1000h  
Item No. 560302



Lamp details

max. 42W QT14

Variant	Item No.
G9   QT14 <input type="checkbox"/> matt white	148016



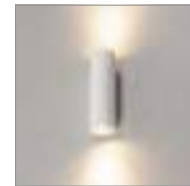

148060 231

PLASTRA  
WL, QPAR51

- Can be individually designed with colours, stickers & more

## Product details

220-240V ~50/60Hz  
Material: gypsum/steel



1,2

## Dimensional drawing

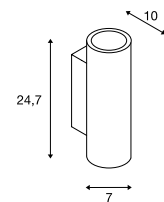

## Recommended lamp

LED 6W 36°  
2700K 460lm  
6kWh/1000h

Item No. 1005075



LED GU10 4W 36°  
2700K 300lm  
4kWh/1000h

Item No. 1004972



## Lamp details

2x max. 35W QPAR51

Variant	Item No.
GU10   QPAR51	
□ matt white	148060

ENOLA B  
WL, QPAR51



SOCKET  
INSIDE



ASTINA UP/DOWN  
WL, QPAR51



SOCKET  
INSIDE



• High-quality, satin-finish glass

Product details

230V ~50Hz  
Material: aluminium/steel



0,57

Dimensional drawing

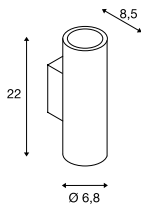

Accessory recommendation

■ Decorative ring  
Item No. 151840



Recommended lamp

LED GU10 6W 36°  
3000K 460lm  
6kWh/1000h  
Item No. 1005078



LED GU10 4W 36°  
3000K 300lm  
4kWh/1000h  
Item No. 1004973



Lamp details

2x max. 50W QPAR51  
L: 8,5 cm max.

Variant	Item No.
GU10   QPAR51	
■ black	151800
□ white	151801
■ gold	151803
■ silver grey	151804

Product details

220-240V ~50/60Hz  
Material: aluminium/steel



0,74

Dimensional drawing

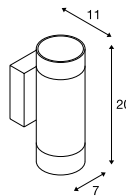

Recommended lamp

LED GU10 7.2W 36°  
4000K 540lm  
8kWh/1000h  
Item No. 1005083



LED GU10 4W 36°  
4000K 300lm  
4kWh/1000h  
Item No. 1004974



Lamp details

2x max. 10W QPAR51

Variant	Item No.
GU10   QPAR51	
■ black	1002933
□ white	1002931
■ grey	1002932



151803 232



1002933 232





1004670 233



1004671 233

OCULUS UP/DOWN  
WL, PHASE



Product details

220-240V ~50/60Hz | 700mA  
 Total wattage: 15W  
 Material: aluminium/glass  
 Dimmable: C

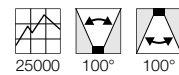
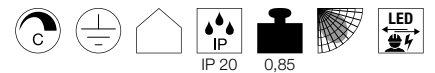

Dimensional drawing

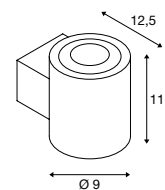

Variant	Item No.
Up: 22-555lm   2000-3000K   CRI>90 Down: 22-555lm   2000-3000K   CRI>90	
■ matt black	1004670
Up: 22-555lm   2000-3000K   CRI>90 Down: 22-555lm   2000-3000K   CRI>90	
□ matt white	1004671

ROX  
WL, QPAR111



ROX UP/DOWN  
WL, QPAR111



SOCKET  
INSIDE



SOCKET  
INSIDE



• High-quality brushed surface

• High-quality brushed surface

Product details

230V -50Hz  
Material: aluminium/glass

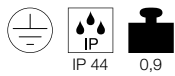

Product details

230V -50Hz  
Material: aluminium/glass

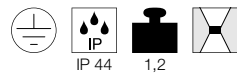

Dimensional drawing

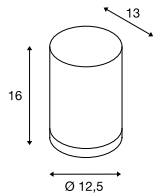

Dimensional drawing

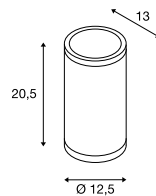

Recommended lamp

LED GU10 13W 30°  
4000K 1100lm  
13kWh/1000h  
Item No. 1003087



LED GU10 7,3W 13°  
2700K 660lm  
8kWh/1000h  
Item No. 1000939



Recommended lamp

LED GU10 13W 30°  
2700K 1100lm  
13kWh/1000h  
Item No. 1001242



LED GU10 13W 30°  
4000K 1100lm  
13kWh/1000h  
Item No. 1003087



Lamp details

max. 50W QPAR111

Lamp details

2x max. 50W QPAR111

Variant	Item No.
GU10   QPAR111 ■ brushed aluminium	1000333

Variant	Item No.
GU10   QPAR111 ■ brushed aluminium	1000334



1000334 234



116340 235

SUPROS 78 UP/DOWN  
WL, PHASE

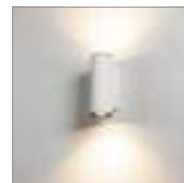

Product details

220-240V ~50/60Hz | 250mA  
Total wattage: 24W  
Material: aluminium  
Dimmable: C, L

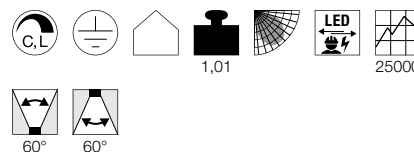

Dimensional drawing

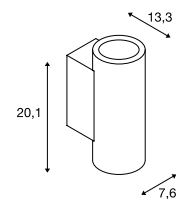

Accessory recommendation

Lens 20°	
<b>Item No. 116302</b>	
Lens 40°	
<b>Item No. 116304</b>	

Variant	Item No.
Up: 700lm   3000K   CRI>80   60° Down: 700lm   3000K   CRI>80   60°	
■ black	<b>116340</b>
Up: 700lm   3000K   CRI>80   60° Down: 700lm   3000K   CRI>80   60°	
□ white	<b>116341</b>

**PLASTRA 101**  
WL, E14



- Can be individually designed with colours, stickers & more

**Product details**

230V -50Hz  
Material: gypsum/steel



**Dimensional drawing**

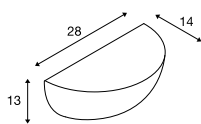

**Recommended lamp**

LED E14 6,5W 280°  
2700K 480lm  
7kWh/1000h  
**Item No. 560372**



LED E14 4,5W 280°  
2700K 470lm  
5kWh/1000h  
**Item No. 1002128**



**Lamp details**

max. 40W C35  
Diameter: 4.5 cm max. L: 11 cm max.

Variant	Item No.
E14   C35 □ matt white	148013

**PLASTRA**  
WL, Curve, QT-DE12

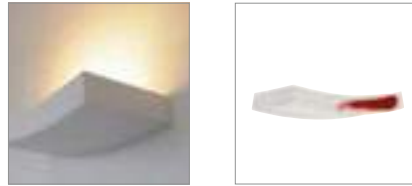

- Can be individually designed with colours, stickers & more

**Product details**

230V -50Hz  
Material: gypsum/steel

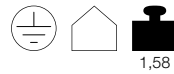

**Dimensional drawing**

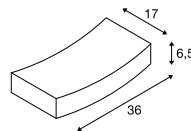

**Recommended lamp**

R7s 78mm 55W 330°  
3000K 530lm  
6kWh/1000h  
**Item No. 560332**



**Lamp details**

max. 100W QT-DE12

Variant	Item No.
R7s 78mm   QT-DE12 □ matt white	148012

**DELWA**  
WL



**Product details**

100-240V ~50/60Hz | 700mA  
Total wattage: 10W  
Material: aluminium/glass



**Dimensional drawing**

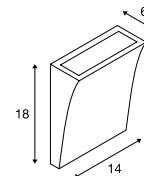

Variant	Item No.
910lm   3000K   CRI>80 □ white	1000340
910lm   3000K   CRI>80 ■ anthracite	1000342



148013    236



1000340    236



148012    236

QUAD FRAME 14  
WL



- The light colour can be selected during installation using a switch

Product details

100-277V ~50/60Hz | 350mA  
Total wattage: 4W  
Material: aluminium

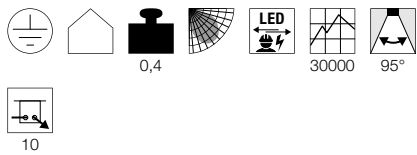

Dimensional drawing

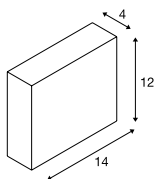

QUAD FRAME 19  
WL



- The light colour can be selected during installation using a switch

Product details

100-240V ~50/60Hz | 500mA  
Total wattage: 11W  
Material: aluminium

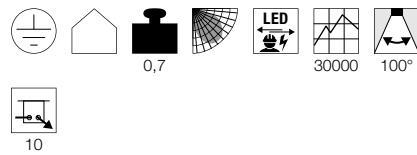

Dimensional drawing

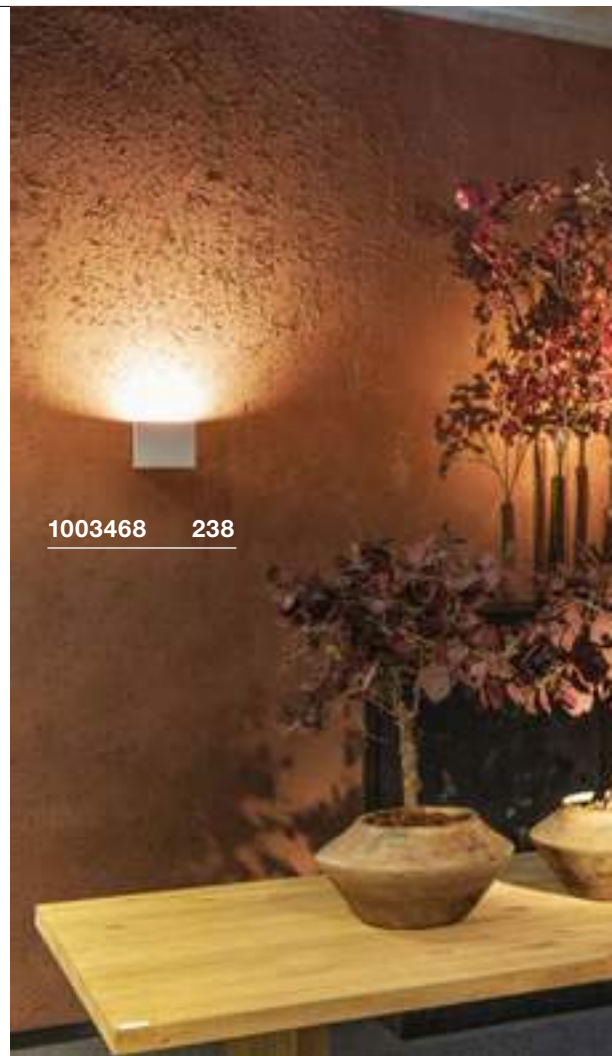
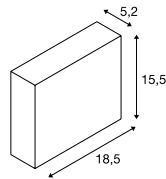

1003468 238

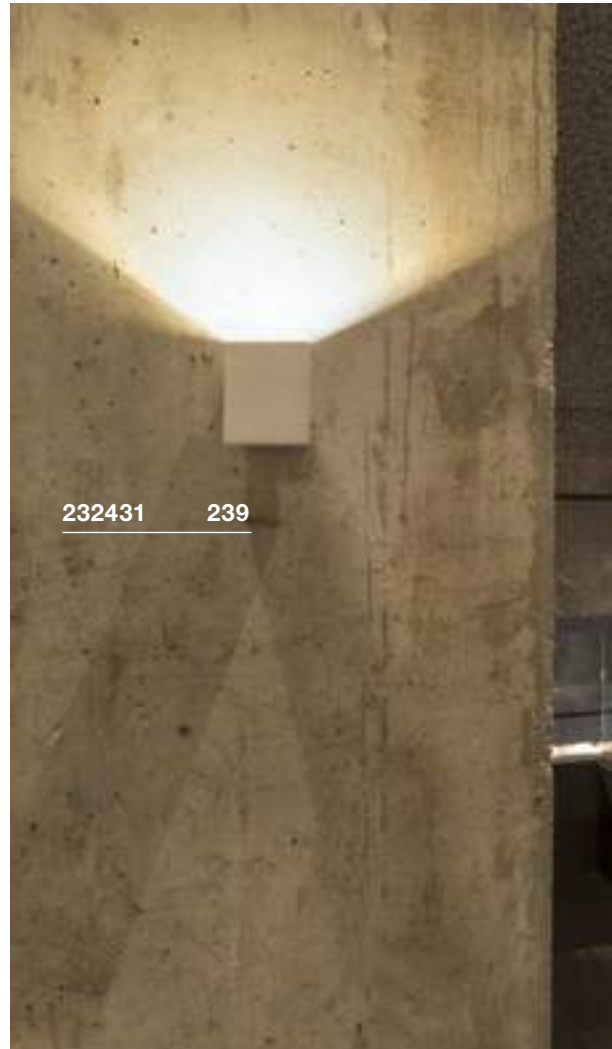

232431 239

Variant	Item No.
130/165lm   2700/3000K   CRI>90 □ matt white	1003467

Variant	Item No.
540/640lm   2700/3000K   CRI>90 □ matt white	1003468



QUAD  
WL



Product details

200-240V ~50/60Hz | 700mA  
Total wattage: 4.6W  
Material: aluminium/glass

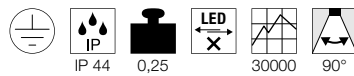

Dimensional drawing

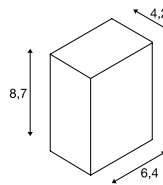

BIG QUAD  
WL



Product details

100-277V ~50/60Hz | 350mA  
Total wattage: 4.5W  
Material: aluminium/glass



Dimensional drawing

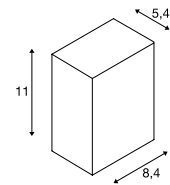

Variant	Item No.
100lm   3000K   CRI>80 □ matt white	232461
80lm   3000K   CRI>80 ■ matt anthracite	232465

Variant	Item No.
290lm   3000K   CRI>80 □ matt white	232431
260lm   3000K   CRI>80 ■ matt anthracite	232435

PEMA®  
WL



1000422 241

**Product details**

230V -50Hz  
Total wattage: 4.7W  
Material: aluminium/glass

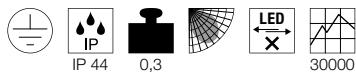

**Dimensional drawing**

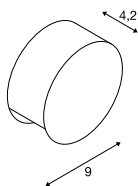

**Tip**

Protection rating IP44 only when mounted with light emission downwards.

231012 240

Variant	Item No.
125lm   3000K   CRI>80 white	231010
125lm   3000K   CRI>80 grey	231012
125lm   3000K   CRI>80 anthracite	231015







SHELL 15  
WL, PHASE



Product details

220-240V ~50/60Hz | 350mA  
Total wattage: 15W  
Material: aluminium/acrylic  
Dimmable: C, L

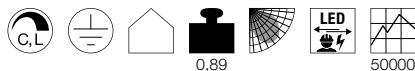

Dimensional drawing

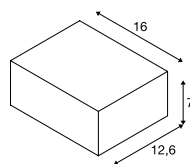

Variant	Item No.
1400lm   3000K   CRI>80 □ white	1000422

SHELL 30  
WL, PHASE



Product details

220-240V ~50/60Hz | 700mA  
Total wattage: 54W  
Material: aluminium/acrylic  
Dimmable: C



Dimensional drawing

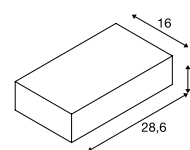

Variant	Item No.
5600lm   3000K   CRI>80 □ white	1000423

LENITO  
WL

1002920 242

LED  
INSIDE**Product details**

220-240V ~50/60Hz | 160mA

Total wattage: 24W

Material: aluminium/polycarbonate (PC)



0,55

30000

340°

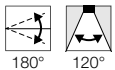

180°

120°

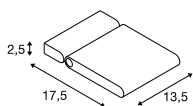
**Dimensional drawing****Variant** **Item No.**

2450lm | 3000K | CRI&gt;80

■ black 1002920

2540lm | 3000K | CRI&gt;80

□ white 1002921



1001468 243

## MERADO FLOOD WL, PHASE



LED  
INSIDE

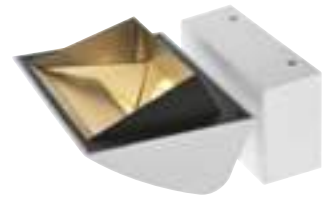

- Asymmetrical light distribution

### Product details

220-240V ~50/60Hz | 1000mA  
Total wattage: 40W  
Material: aluminium  
Dimmable: C, L

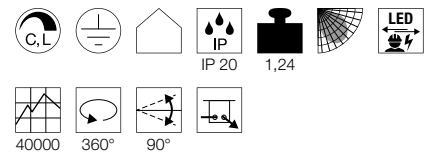

### Dimensional drawing

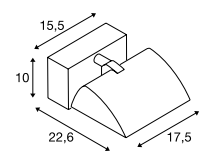

Variant	Item No.
3000lm   3000K   CRI>80	
■ black	<b>1001469</b>
3000lm   3000K   CRI>80	
□ white	<b>1001468</b>
3200lm   4000K   CRI>80	
■ black	<b>1001473</b>
3200lm   4000K   CRI>80	
□ white	<b>1001472</b>

FENDA  
WL, Base, E27



SOCKET  
INSIDE



- Can be individually altered through the selection of a suitable lampshade

Product details

230V -50Hz  
Material: steel



Dimensional drawing

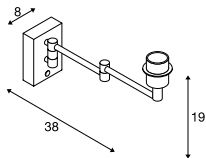

Recommended lamp

LED E27 7W 280°  
2700K 790lm  
7kWh/1000h  
Item No. 1002127



LED E27 7W  
2700K 810lm  
7kWh/1000h  
Item No. 1003090



Lamp details

max. 40W  
L: 12 cm max.

Variant	Item No.
E27	
■ black	1001450
■ chrome	1001449



1001450 + 156113 244 + 105



1003034 + 156152 245 + 104

FENDA  
WL, E27



SOCKET  
INSIDE



- Can be individually altered through the selection of a suitable lampshade
- Rotating and pivoting wall light
- Switch on the rose

Product details

220-240V ~50/60Hz  
Material: steel/aluminium



0,56 350° 90°

Dimensional drawing

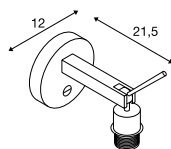

FENDA  
Diameter 20cm, round



- Can be individually altered through the selection of a suitable light base

Product details

Material: textile/steel



0,19

Dimensional drawing

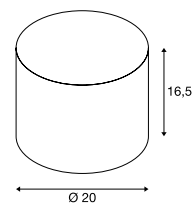

Tip

max. 60W



Recommended lamp

LED E27 9.1W 240°  
2700K 760lm  
10kWh/1000h  
Item No. 560402



LED E27 7W 280°  
2700K 790lm  
7kWh/1000h  
Item No. 1002127



Lamp details

max. 40W

Variant	Item No.
E27	
■ matt black	1003034
E27	
□ matt white	1003035

Variant	Item No.
■ black	1001451
■ black/copper	1001452
□ white	1001453
■ beige	1001454

**KENKUA SPOT**  
WL, E27

SOCKET  
INSIDE  
LED  
INSIDE



- High-quality, satin-finish glass
- Adjustable reading light
- Lightbulbs on the rose available separately

**Product details**

100-277V ~50/60Hz | 700mA  
Material: steel/glass

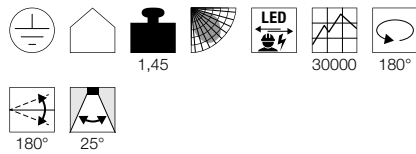

**Dimensional drawing**

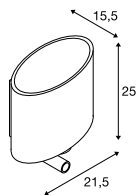

**Recommended lamp**

LED E27 9.1W 240°  
2700K 760lm  
10kWh/1000h  
Item No. 560402



**Lamp details**

max. 40W

Variant	Item No.
E27 Spot: 200lm   3000K   CRI>80 chrome/white	1002855

**KENKUA**  
WL, E27

SOCKET  
INSIDE



- High-quality, satin-finish glass

**Product details**

220-240V ~50/60Hz  
Material: steel/glass



**Dimensional drawing**

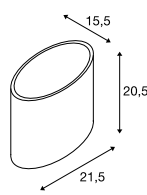

**Recommended lamp**

LED E27 14.5W 200°  
2700K 1521lm  
15kWh/1000h  
Item No. 560422



**Lamp details**

max. 40W

Variant	Item No.
E27 chrome/white	1002856

**ACCANTO SPOT SQUARE**  
WL, E27



SOCKET  
INSIDE  
LED  
INSIDE



**Product details**

230V -50Hz  
Material: steel/textile

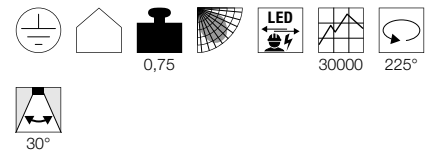

**Dimensional drawing**

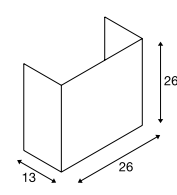

**Recommended lamp**

LED E27 7W  
2700K 810lm  
7kWh/1000h  
Item No. 1003090



**Lamp details**

max. 24 W  
L: 17.3 cm max.

Variant	Item No.
E27 Spot: 100lm   3000K   CRI>80 black	155670
E27 Spot: 100lm   3000K   CRI>80 white	155673

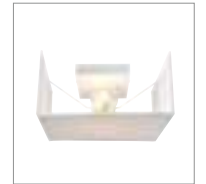

155670 246

ACCANTO  
WL, E27SOCKET  
INSIDE

## Product details

220-240V ~50/60Hz  
Material: steel/textile

0,68

## Dimensional drawing

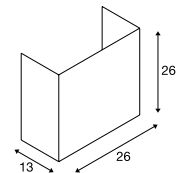

1002856 246

1002855 246

## Recommended lamp

LED E27 9.1W 240°  
2700K 760lm  
10kWh/1000h  
Item No. 560402LED E27 7W  
2700K 810lm  
7kWh/1000h  
Item No. 1003090

## Lamp details

max. 40W

Variant	Item No.
E27	
■ black	1002942
E27	
□ white	1002943

COUPA FLEX  
WL

SOCKET  
INSIDE  
LED  
INSIDE



- Lightbulbs available separately
- Switch on the rose

Product details

230V -50Hz  
Total wattage: 4.8W  
Material: steel/glass



1,3

30000

30°

Dimensional drawing

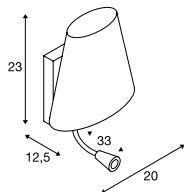

Recommended lamp

LED G9 2.7W  
2600K 250lm  
3kWh/1000h  
Item No. 1003102



LED G9 2.5W  
2700K 180lm  
3kWh/1000h  
Item No. 560302



Lamp details

max. 40W QT14  
L: 9cm max.

Variant	Item No.
---------	----------

G9 | QT14  
Spot: 125lm | 3000K | CRI>80  
chrome/white 149452

149452 248







1002859 249

**COUPA  
WL, QT14****SOCKET  
INSIDE**

- High-quality, satin-finish glass

**Product details**

220-240V ~50/60Hz  
Material: steel/glass

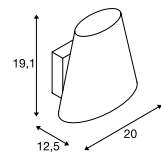

1,12

**Dimensional drawing****Recommended lamp**

LED G9 2.7W  
2600K 250lm  
3kWh/1000h  
Item No. 1003102



LED G9 2.5W  
2700K 180lm  
3kWh/1000h  
Item No. 560302

**Lamp details**

max. 42W QT14  
L: 9cm max.

Variant	Item No.
G9   QT14 chrome/white	1002859

KARPO MAGN  
CW, single, PHASE



NEW



LED  
INSIDE



- The light head adheres magnetically to the light base

Product details

220-240V ~50/60Hz | 500mA  
Total wattage: 6.2W  
Material: steel/aluminium  
Dimmable: C



0,34

25000



38°

Dimensional drawing

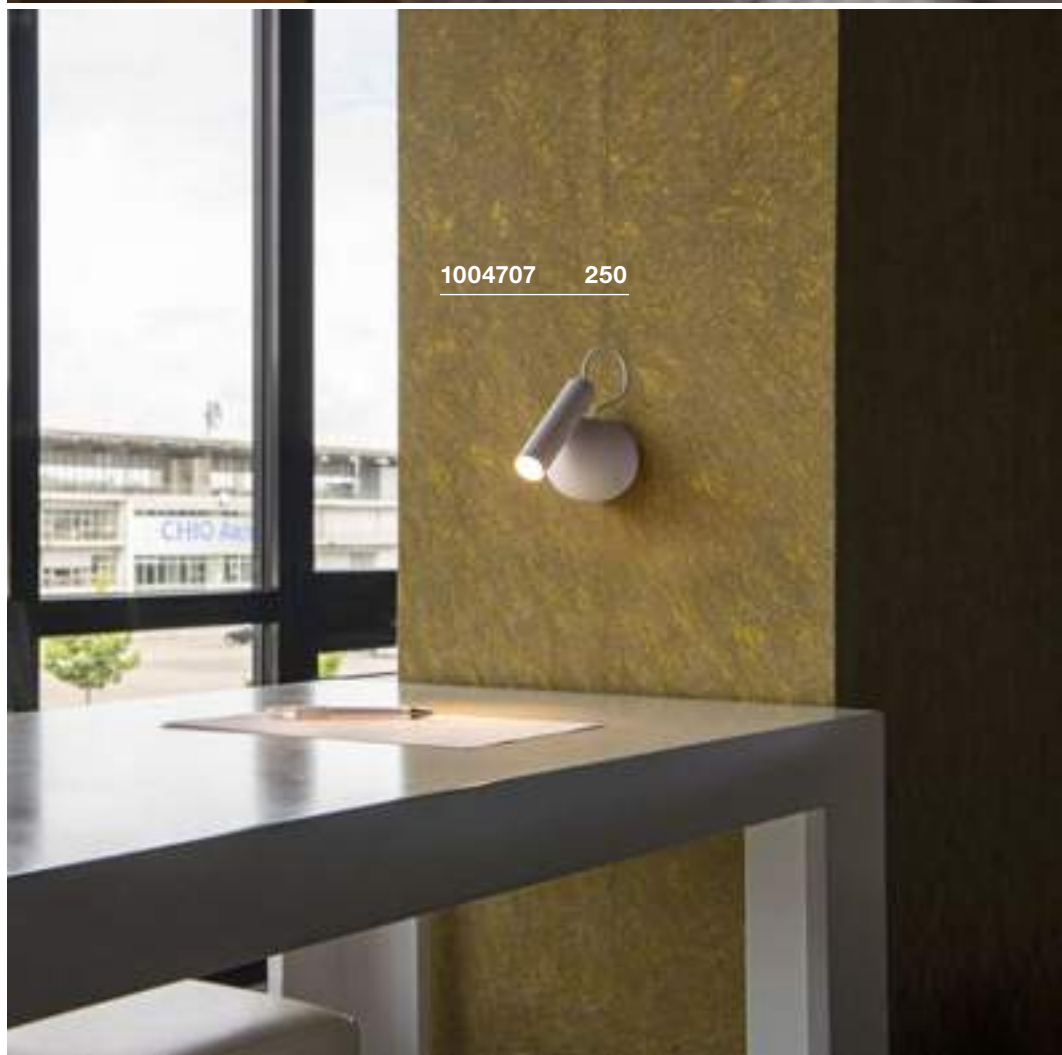
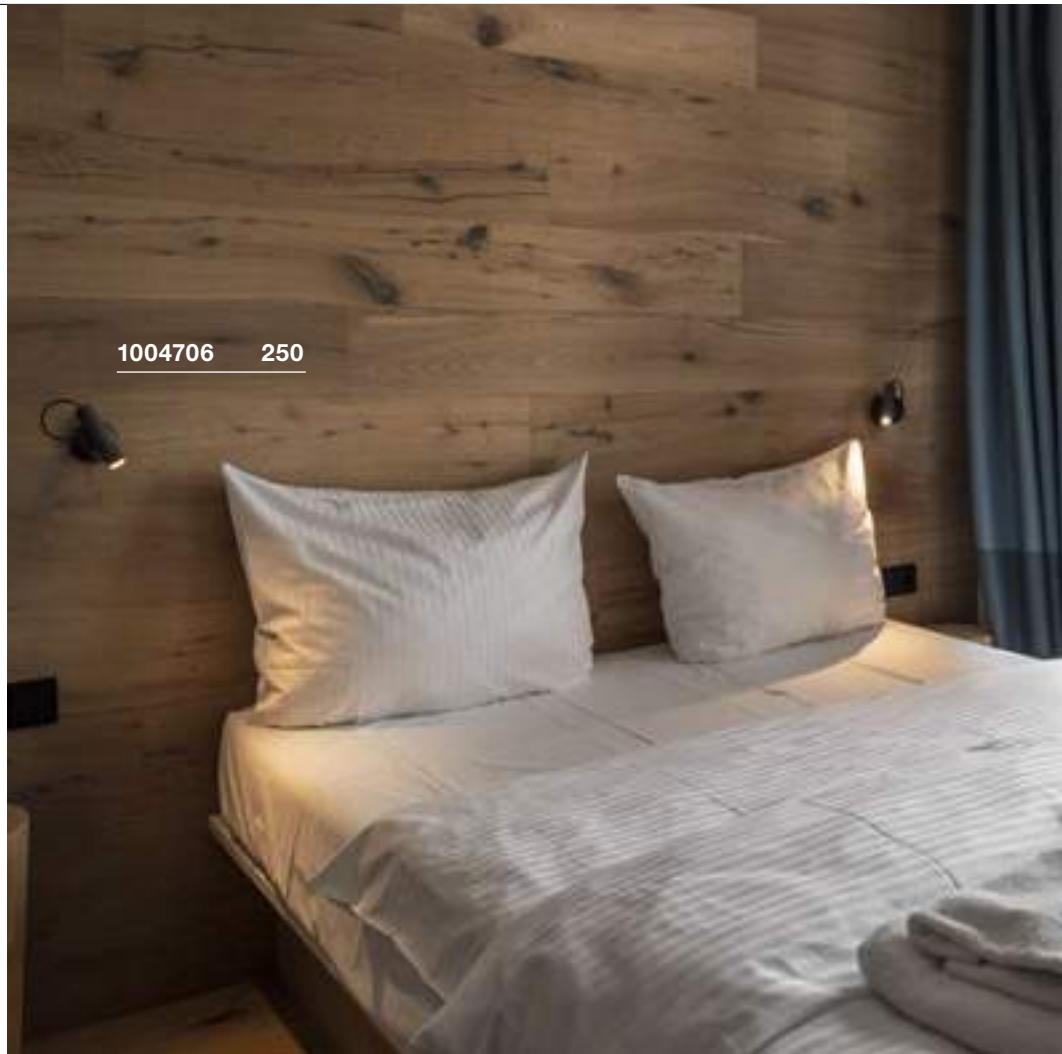
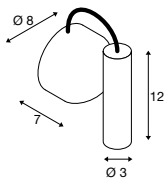

Variant	Item No.
350lm   3000K   CRI>90	
■ matt black	1004706
430lm   3000K   CRI>90	
□ matt white	1004707

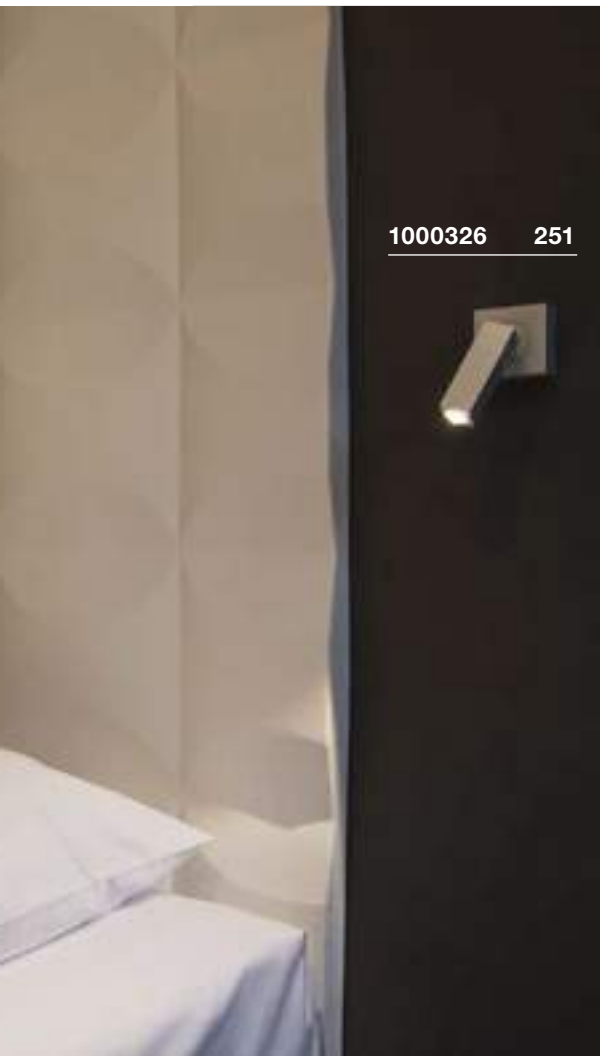

1000326 251

STIX  
WL



- Rotating and pivoting light head
- Switch on the rose

Product details

100-240V ~50/60Hz | 700mA  
Total wattage: 4.5W  
Material: aluminium

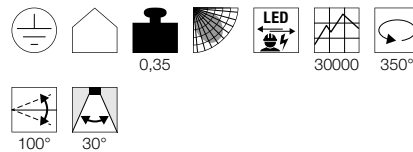

Dimensional drawing

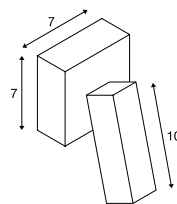

148540 251

PHELIA  
WL, QPAR51



SOCKET  
INSIDE



- Switch on light body
- Lampshade painted white on the inside

Product details

230V ~50/60Hz  
Material: aluminium/steel



Dimensional drawing

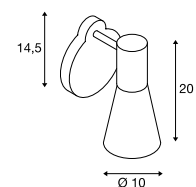

Recommended lamp

LED GU10 6W 36°  
2700K 460lm  
6kWh/1000h  
Item No. 1005077



LED GU10 4W 36°  
2700K 300lm  
4kWh/1000h  
Item No. 1004972



Lamp details

max. 35W QPAR51  
Diameter: 5 cm max. L: 10.5 cm max.

Variant	Item No.
185lm   3000K   CRI80	
■ black	1000324 ▼
185lm   3000K   CRI80	
■ grey	1000326 ▼

Variant	Item No.
GU10   QPAR51	
■ black	148540

ENOLA B  
WL, QPAR51



SOCKET  
INSIDE



1000731 252



- Switch on the rose

Product details

230V -50Hz  
Material: aluminium/steel



0,44 350°

Dimensional drawing

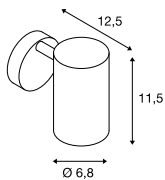

Accessory recommendation

- Decorative ring  
Item No. 151840



Recommended lamp

LED GU10 5.5W 38°  
2700K 400lm  
6kWh/1000h  
Item No. 1001030



LED GU10 4W 36°  
2700K 300lm  
4kWh/1000h  
Item No. 1004972



Lamp details

max. 50W QPAR51  
L: 6 cm max.

Variant	Item No.
GU10   QPAR51	
■ black	1000729
□ white	1000730
■ gold	1000731
■ grey	1000732





152341 253

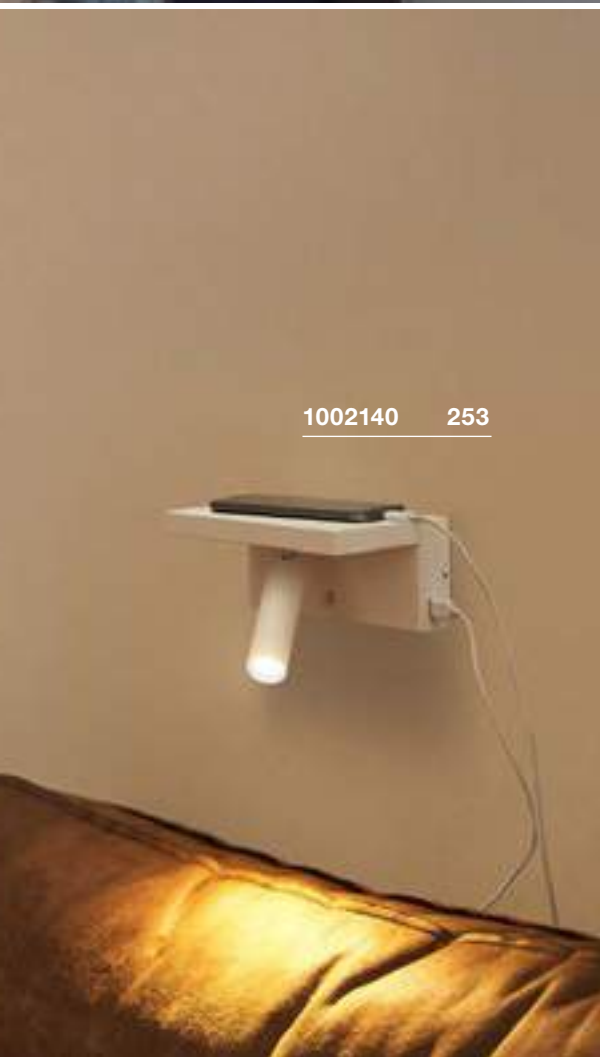

1002140 253

KARPO 30  
CW, single



- Premium LED with CRI>90
- Switch on the rose

Product details

100-240V ~50/60Hz | 500mA  
Total wattage: 6W  
Material: aluminium/steel

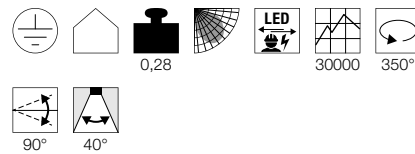

Dimensional drawing

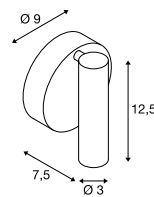

KARPO  
WL



- Premium LED with CRI>90
- 3-Step touch dimmer on the base
- Two USB ports (1.5A max)

Product details

220-240V ~50/60Hz | 500mA  
Total wattage: 6.6W  
Material: aluminium  
Dimmable: switch

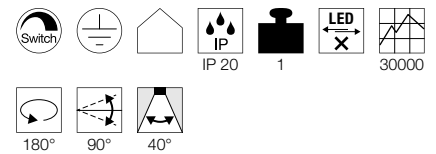

Dimensional drawing

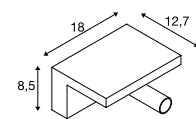

Variant	Item No.
330lm   3000K   CRI>90	
■ black	152340
380lm   3000K   CRI>90	
□ white	152341
360lm   3000K   CRI>90	
■ gold	1002173

Variant	Item No.
390lm   3000K   CRI>90	
□ white	1002140

SOMNILA SPOT  
WL, left



- Practical storage for smartphones
- USB charging function
- Lightbulbs can be switched on/off separately
- Direct and indirect light

Product details

100-240V ~50/60Hz | 12V  
Total wattage: 13W  
Material: aluminium/steel

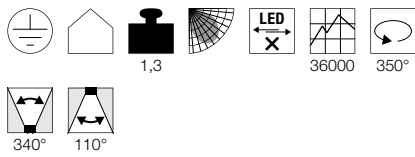

Dimensional drawing

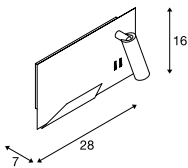

SOMNILA SPOT  
WL, right



- Practical storage for smartphones
- USB charging function
- Lightbulbs can be switched on/off separately
- Direct and indirect light

Product details

100-240V ~50/60Hz | 12V  
Total wattage: 13W  
Material: aluminium/steel

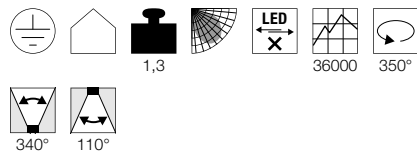

Dimensional drawing

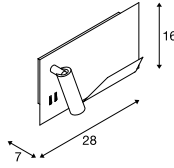

1003455 254



1003457 254

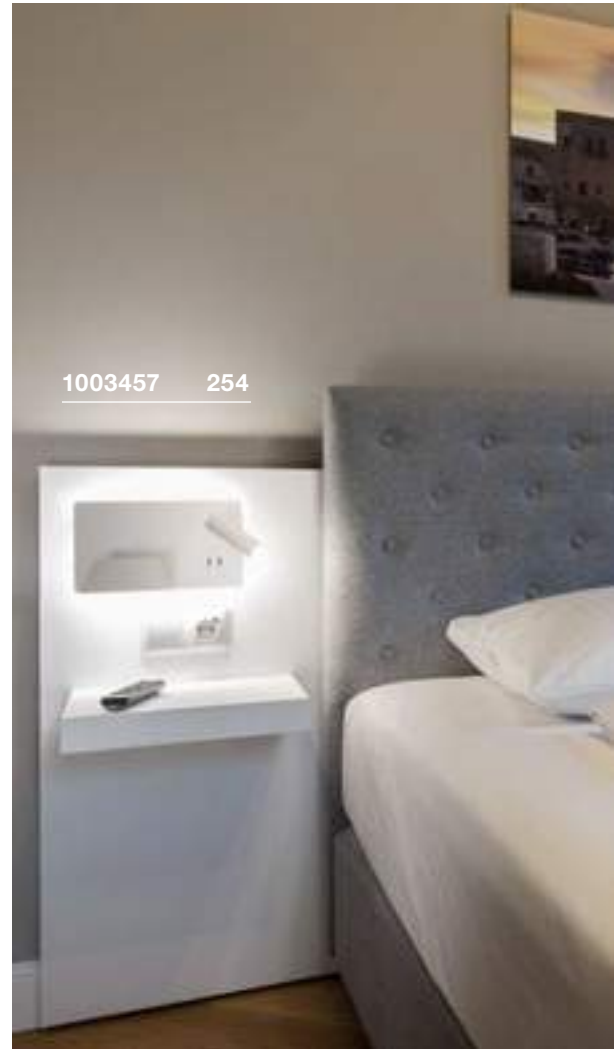

Variant	Item No.
Spot: 65lm   3000K   CRI>90 Indirect:: 370lm   3000K   CRI>90 ■ matt black	<b>1003455</b>
Spot: 65lm   3000K   CRI>90 Indirect:: 646lm   3000K   CRI>90 □ matt white	<b>1003457</b>

Variant	Item No.
Spot: 65lm   3000K   CRI>90 Indirect:: 370lm   3000K   CRI>90 ■ matt black	<b>1003456</b>
Spot: 65lm   3000K   CRI>90 Indirect:: 646lm   3000K   CRI>90 □ matt white	<b>1003458</b>

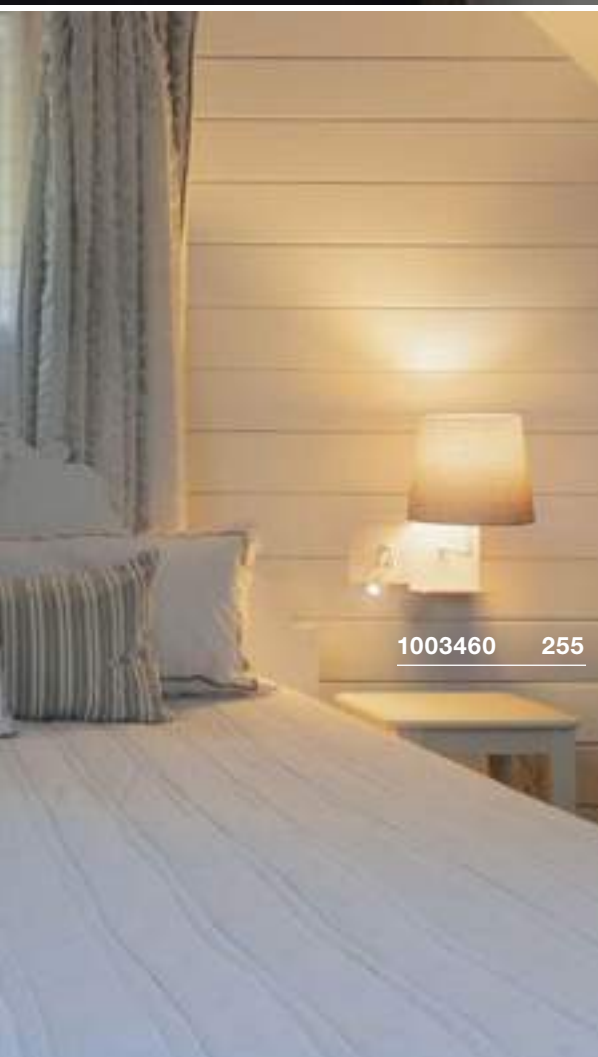

**SOMNILA FLEX**  
WL, left

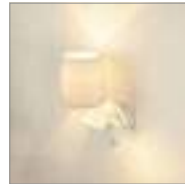

- Practical storage for smartphones
- USB charging function
- Lightbulbs can be switched on/off separately

**Product details**

100-240V ~50/60Hz | 12V  
Material: aluminium/textile



1,8 36000 110°

**Dimensional drawing**

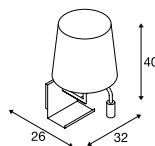

**Recommended lamp**

LED E27 9.1W 240°  
2700K 760lm  
10kWh/1000h  
Item No. 560402



LED E27 7W  
2700K 810lm  
7kWh/1000h  
Item No. 1003090



**Lamp details**

40W  
L: 18 cm max.

Variant	Item No.
E27 Spot: 65lm   3000K   CRI>90 <input type="checkbox"/> matt white	1003459

**SOMNILA FLEX**  
WL, right



- Practical storage for smartphones
- USB charging function
- Lightbulbs can be switched on/off separately

**Product details**

100-240V ~50/60Hz | 12V  
Material: aluminium/textile



1,8 36000 110°

**Dimensional drawing**

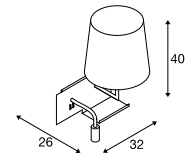

**Recommended lamp**

LED E27 14.5W 200°  
2700K 1521lm  
15kWh/1000h  
Item No. 560422



**Lamp details**

40W  
L: 18 cm max.

Variant	Item No.
E27 Spot: 65lm   3000K   CRI>90 <input type="checkbox"/> matt white	1003460

146700 256



PIPOFLEX  
WL



- Switch on the rose

Product details

220-240V ~50/60Hz | 266mA  
Total wattage: 4.6W  
Material: aluminium



Dimensional drawing

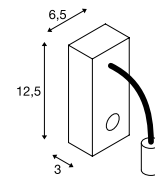

Variant	Item No.
200lm   3000K   CRI>80	
■ black	146700
200lm   3000K   CRI>80	
□ white	146701
200lm   3000K   CRI>80	
■ grey	146704



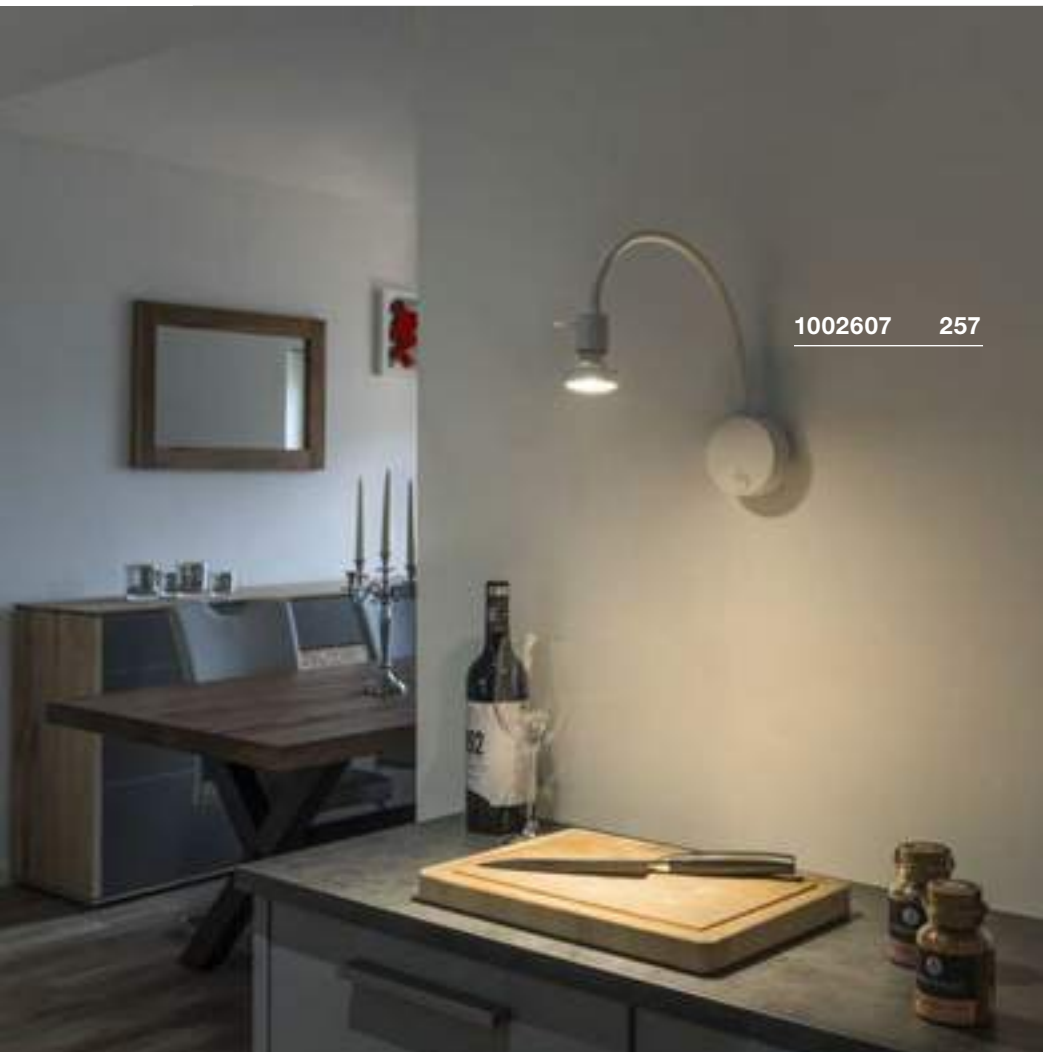

1002607 257

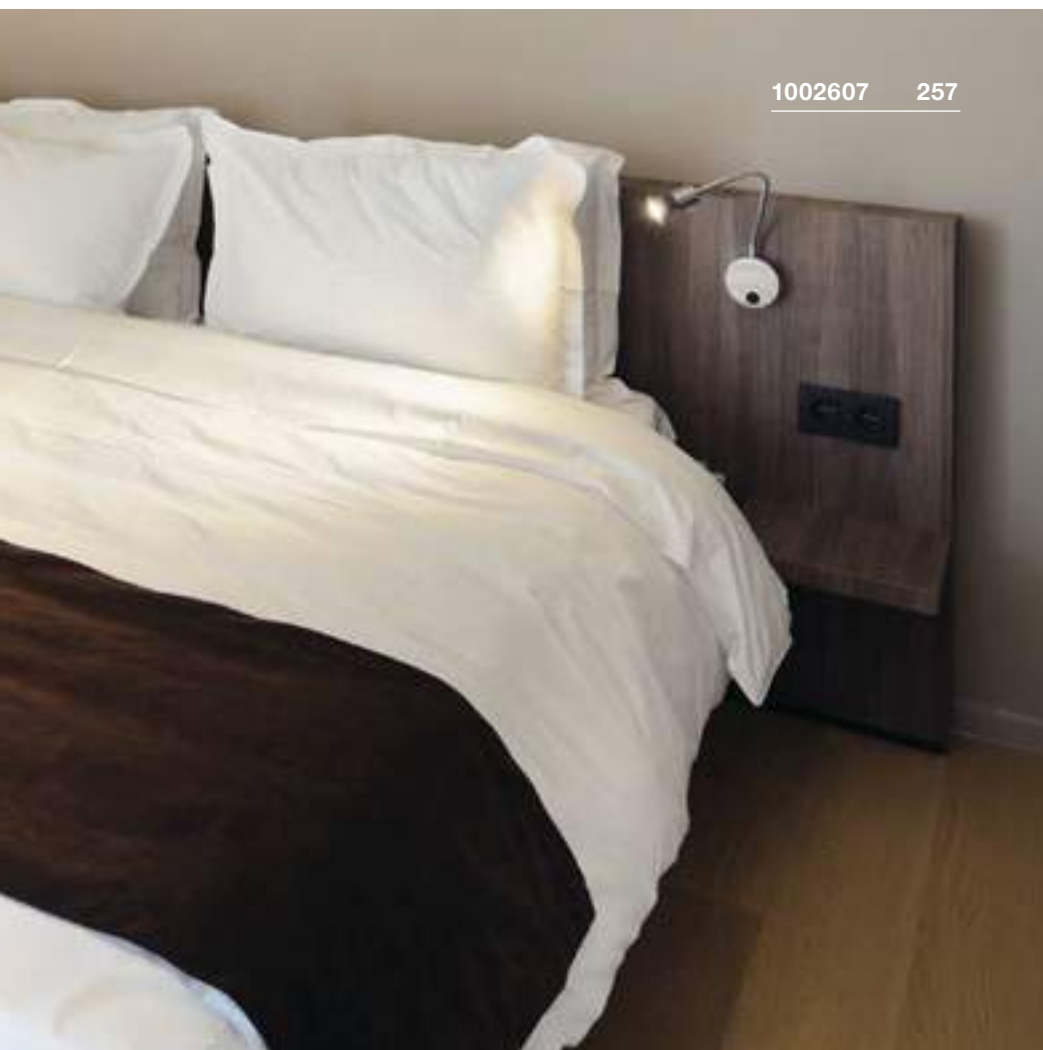

1002607 257

## DIO FLEX PLATE WL QPAR51

SOCKET  
INSIDE



- Switch on the rose

### Product details

230V -50Hz  
Material: aluminium



0,42

### Dimensional drawing

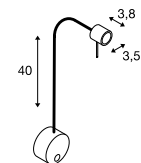

### Accessory recommendation

■ Lamp decorative ring diameter 5.7cm  
Item No. 151040



□ Lamp decorative ring diameter 5.7cm  
Item No. 151041



■ Lamp decorative ring diameter 5.7cm  
Item No. 151049



### Recommended lamp

LED GU10 5.5W 38°  
2700K 400lm  
6kWh/1000h  
Item No. 1001030



LED GU10 4W 36°  
2700K 300lm  
4kWh/1000h  
Item No. 1004972



### Lamp details

max. 50W QPAR51

Variant	Item No.
GU10   QPAR51	
■ black	1002608
□ white	1002607
■ chrome	146692

DIO FLEX PLATE  
WL



- Switch on the rose

Product details

100-240V ~50/60Hz | 320mA  
Total wattage: 1.9W  
Material: aluminium



Dimensional drawing

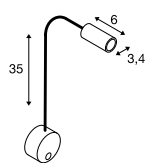

1002117 258

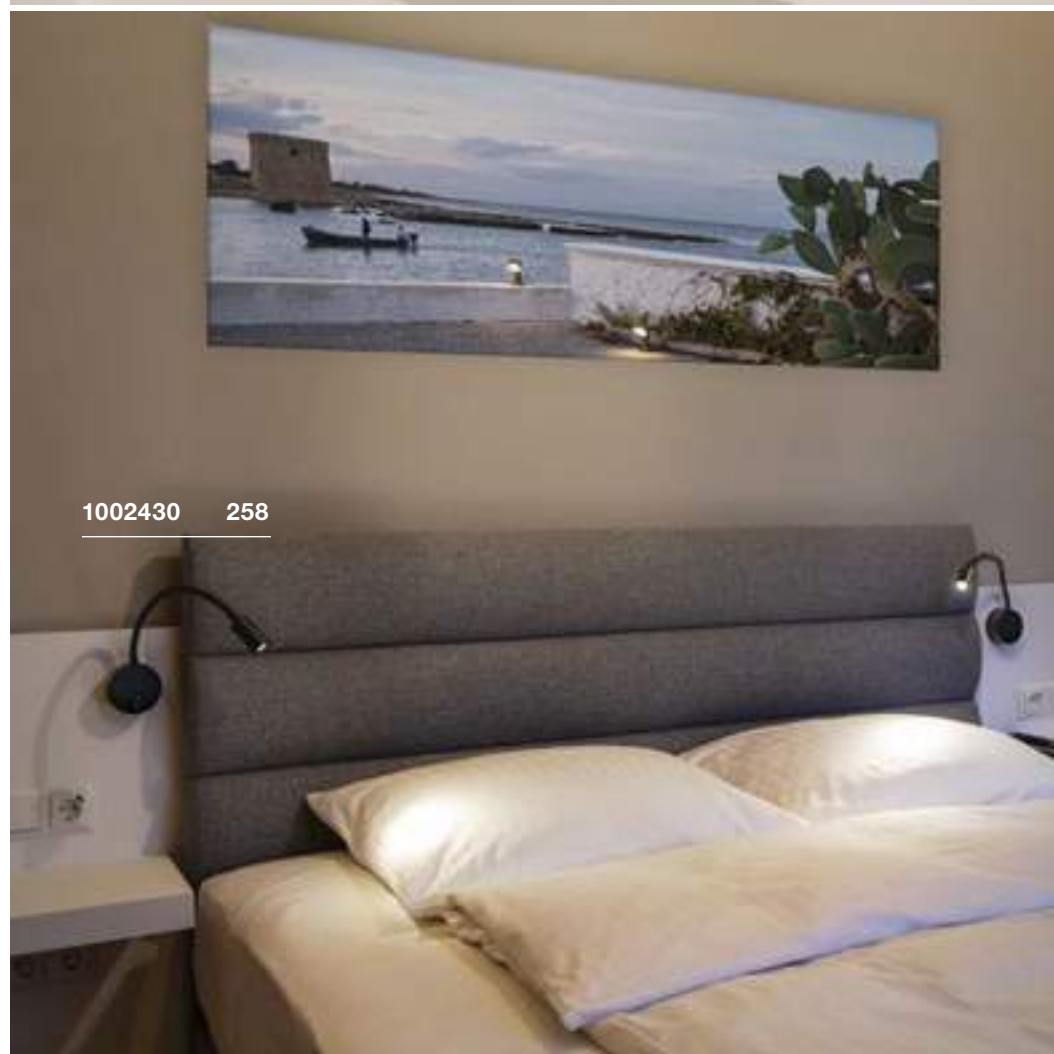

1002430 258

Variant	Item No.
82lm   2700K   CRI>80	
□ white	1002117
82lm   2700K   CRI>80	
■ chrome	1002116
82lm   2700K   CRI>80	
■ black	1002430
82lm   3000K   CRI>80	
□ white	1002118
82lm   3000K   CRI>80	
■ chrome	146682
82lm   3000K   CRI>80	
■ black	1002431
82lm   4000K   CRI>80	
□ white	1002119
82lm   4000K   CRI>80	
■ chrome	146680
82lm   4000K   CRI>80	
■ black	1002432



## IVED GOOSE

WL, Rose

LED  
INSIDE



146512 259

### Product details

100-240V ~50/60Hz | 350mA  
Total wattage: 2.2W  
Material: aluminium

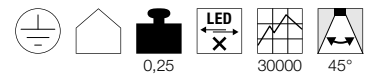

### Dimensional drawing

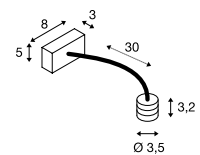

Variant	Item No.
80lm   3000K   CRI>80 ■ grey	146512

MAGANDA  
WL



- 3-times optical magnification
- Select from 3 light colours
- Touch sensitive switch

Product details

100-240V ~50/60Hz | 12V  
Total wattage: 4.8W  
Material: steel/glass

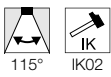

Dimensional drawing

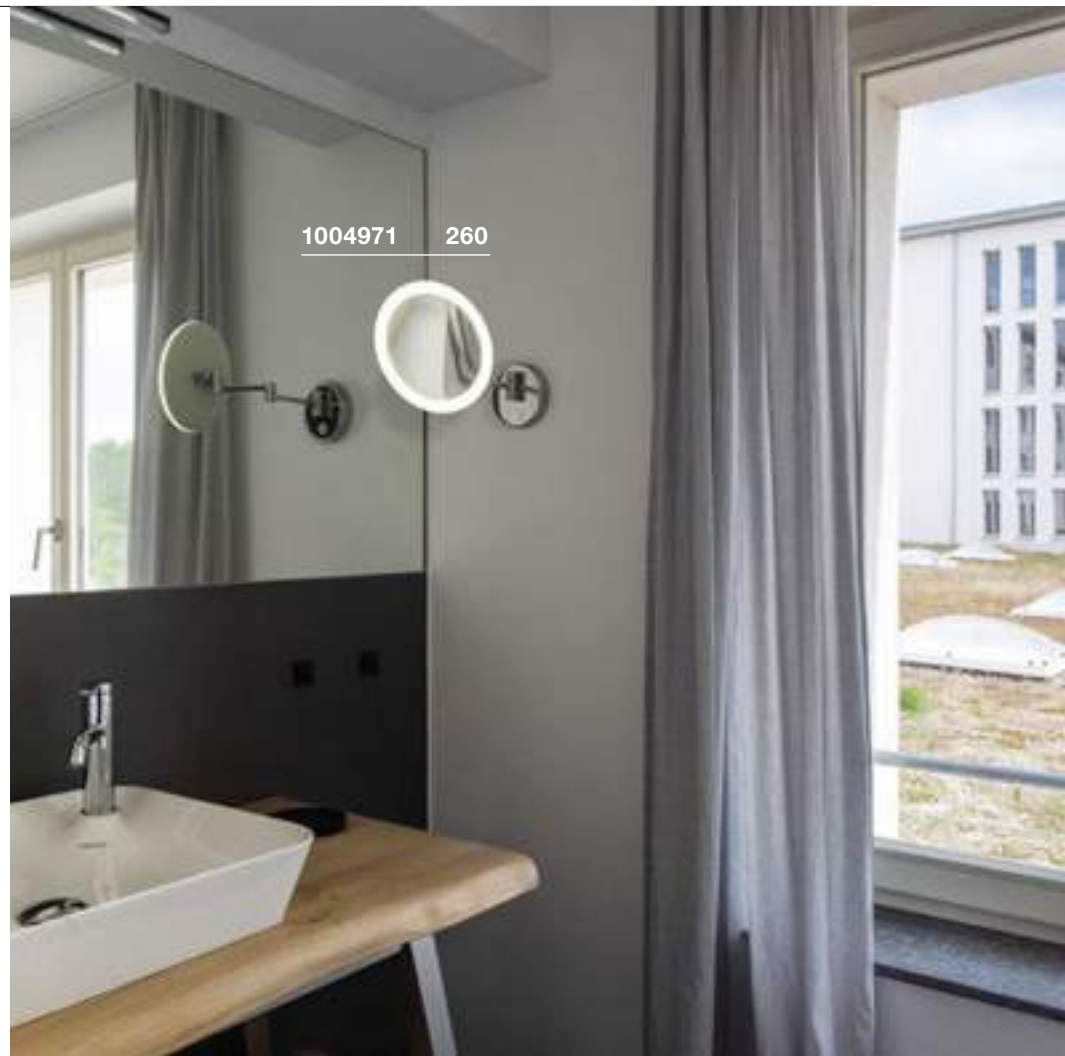
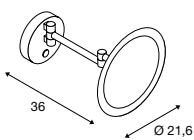

1004971 260



1004730 261

Variant	Item No.
45/48/51lm   2700/3000/4000K   CRI>90	
chrome/white	1004971

TRUKKO  
WL, rectangular



- A unique surface coating prevents the mirror from steaming
- Touch control

Product details

220-240V ~50/60Hz | 24V  
Total wattage: 25W  
Material: glass/plastic  
Dimmable: switch

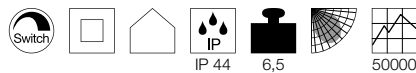

Dimensional drawing

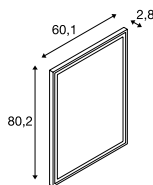

Variant	Item No.
1080/1290/1250lm   3000/4000/6500K   CRI>90 ■ silver	1004730

TRUKKO  
WL, round

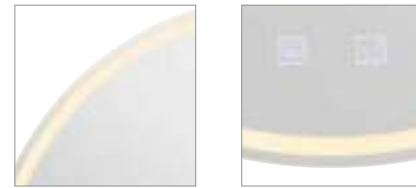

- A unique surface coating prevents the mirror from steaming
- Touch control

Product details

220-240V ~50/60Hz | 24V  
Total wattage: 25W  
Material: glass/plastic  
Dimmable: switch

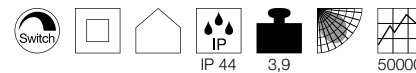

Dimensional drawing

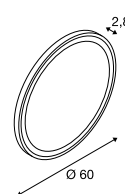

Variant	Item No.
1270/1260/1260lm   3000/4000/6500K   CRI>90 ■ silver	1004731

TRUKKO 60/90  
WL



Product details

100-240V ~50/60Hz | 500mA  
Material: steel/plastic

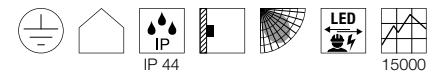

Dimensional drawing

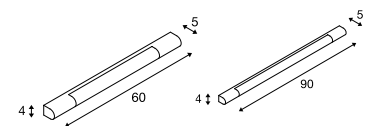

Variant	Item No.
450lm   8,8W   3000K   CRI>80 H: 60 cm   0.75 kg	149762
710lm   11,4W   3000K   CRI>80 H: 90 cm   0.8 kg	149772

MARYLIN 40/60/90  
WL



Product details

220-240V ~50/60Hz | 600mA  
Material: aluminium/polycarbonate (PC)

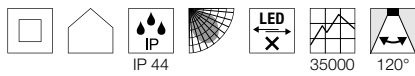

Dimensional drawing

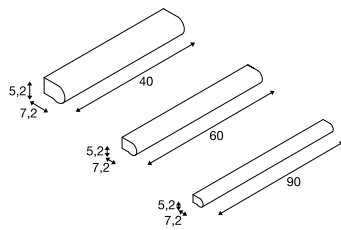

Variant	Item No.
800lm   10W   3000K   CRI>80 L: 40 cm   0.85 kg chrome/white	1002190
1200lm   15W   3000K   CRI>80 L: 60 cm   1.12 kg chrome/white	1002191
1700lm   21W   3000K   CRI>80 L: 90 cm   1.64 kg chrome/white	1002192

DEVIN  
WL, Double, PHASE

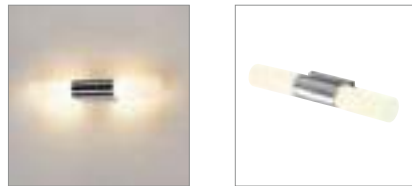

- Elegant aluminium/glass combination

Product details

220-240V ~50/60Hz  
Total wattage: 16W  
Material: steel/glass  
Dimmable: C, L

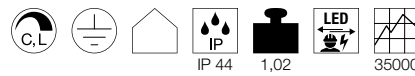

Dimensional drawing

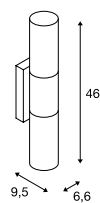

Variant	Item No.
890lm   3000K   CRI>80 chrome/white	151553

1002192 262



151553 262



WL 106  
E14

SOCKET  
INSIDE



Product details

220-240V ~50/60Hz  
Material: aluminium/glass



Dimensional drawing

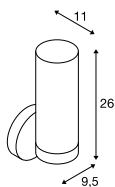

Recommended lamp

LED E14 4,5W 280°  
2700K 470lm  
5kWh/1000h  
Item No. 1002128



LED E14 6,5W 280°  
2700K 480lm  
7kWh/1000h  
Item No. 560372



Lamp details

max. 40W  
Diameter: 3.6 cm max. L: 11 cm max.

Variant	Item No.
E14	
chrome	1002228

WL 106  
E14

SOCKET  
INSIDE



Product details

220-240V ~50/60Hz  
Material: aluminium/glass



Dimensional drawing

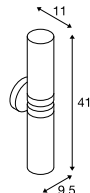

Recommended lamp

LED E14 4,5W 280°  
2700K 470lm  
5kWh/1000h  
Item No. 1002128



LED E14 6,5W 280°  
2700K 480lm  
7kWh/1000h  
Item No. 560372



Lamp details

2x max. 40W  
Diameter: 3.6 cm max. L: 11 cm max.

Variant	Item No.
E14	
chrome	1002229



1002228 263



151282 264

## MIBO UP/DOWN WL, QT14

SOCKET  
INSIDE

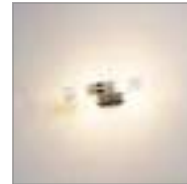

### Product details

220-240V ~50/60Hz  
Material: aluminium/glass



IP 21 0,4

### Dimensional drawing

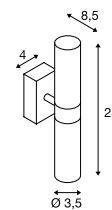

### Recommended lamp

LED G9 2.7W  
2600K 250lm  
3kWh/1000h  
Item No. 1003102



LED G9 2.5W  
2700K 180lm  
3kWh/1000h  
Item No. 560302



### Lamp details

2x max. 25W QT14

Variant	Item No.
G9   QT14	
■ chrome	151282



DORISA 30



- Can be converted to a mirror light by removing the bracket

Product details

220-240V ~50/60Hz | 340mA  
 Total wattage: 5.2W  
 Material: aluminium/plastic

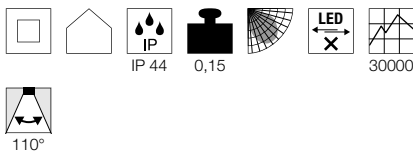

Dimensional drawing

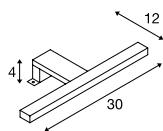

Tip

Clamping range: 0-6 mm

Variant	Item No.
280lm   4000K   CRI>80	
chrome	1000777
280lm   4000K   CRI>80	
matt grey	1000778

DORISA 50



- Can be converted to a mirror light by removing the bracket

Product details

220-240V ~50/60Hz | 340mA  
 Total wattage: 6.6W  
 Material: aluminium/plastic

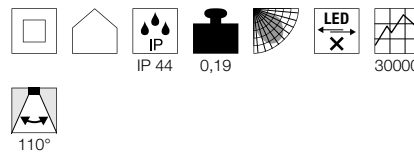

Dimensional drawing

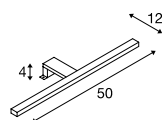

Tip

Clamping range: 0-6 mm

Variant	Item No.
370lm   4000K   CRI>80	
chrome	1000780
370lm   4000K   CRI>80	
matt grey	1000781



1000778 265



1000780 265

# BATHROOM LIGHTING HIGHLIGHTS.

OUR PERFECT LIGHTING  
FOR YOUR BATHROOM.



1000669 269



GLENOS® 60 | 219



L-LINE 60 | 220



L-LINE 120 | 220



Q-LINE® | 221



146800 267

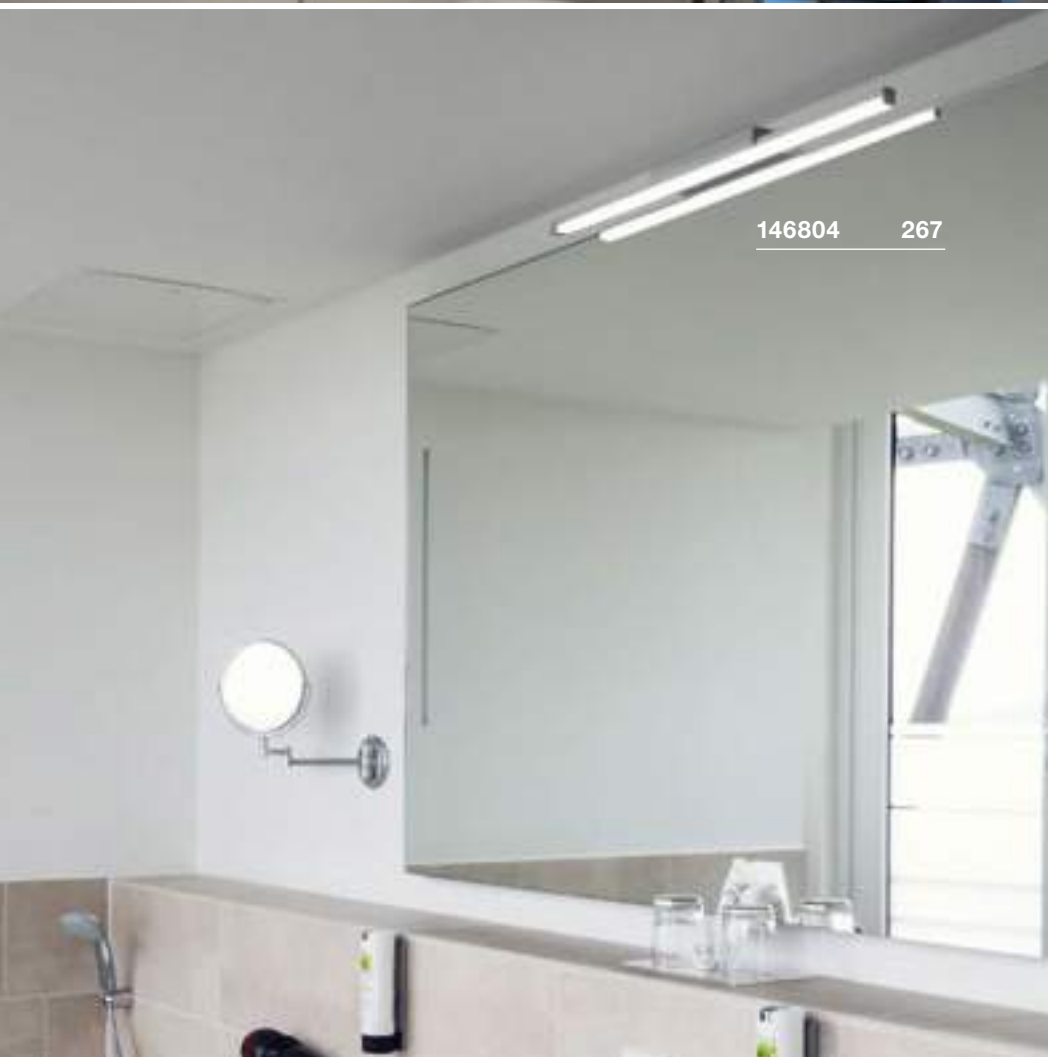

146804 267

### GLENOS® 60

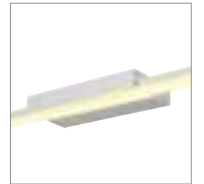
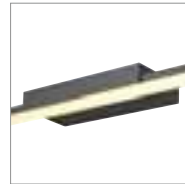

#### Product details

100-240V ~50/60Hz | 24V DC  
 Total wattage: 17W  
 Material: aluminium/acrylic

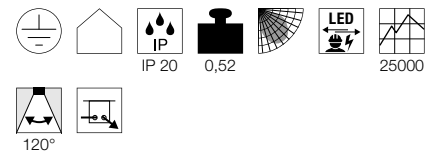

#### Dimensional drawing

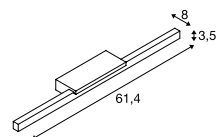

Variant	Item No.
1000lm   3000K   CRI>80	
■ black	146800
1000lm   3000K   CRI>80	
□ white	146801
1000lm   3000K   CRI>80	
■ grey	146804

L-LINE 60



L-LINE 120



Product details

220-240V ~50/60Hz | 350mA  
 Total wattage: 10W  
 Material: aluminium/polycarbonate (PC)

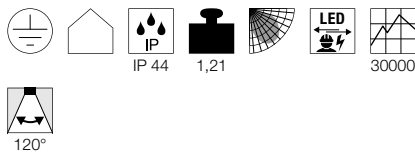

Product details

220-240V ~50/60Hz | 350mA  
 Total wattage: 18.5W  
 Material: aluminium/polycarbonate (PC)

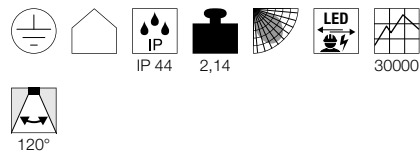

Dimensional drawing

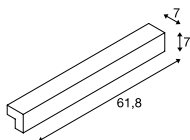

Dimensional drawing

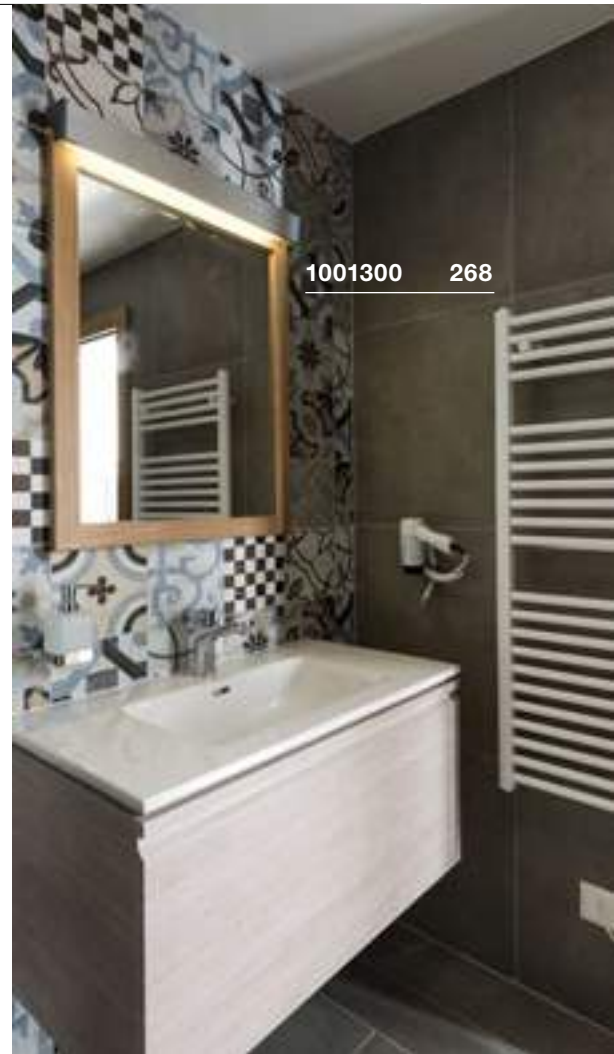
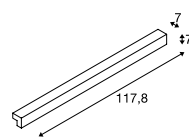

1001300 268



1001305 268

Variant	Item No.
820lm   3000K   CRI>80	
□ white	1001299
820lm   3000K   CRI>80	
■ matt silver	1001300
820lm   3000K   CRI>80	
■ grey	1001301

Variant	Item No.
1650lm   3000K   CRI>80	
□ white	1001303
1650lm   3000K   CRI>80	
■ matt silver	1001304
1650lm   3000K   CRI>80	
■ grey	1001305



1000668 269



1000670 269

Q-LINE®  
WL

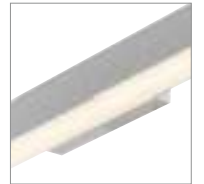
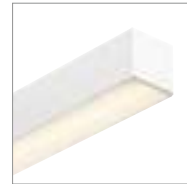

**Product details**

220-240V ~50/60Hz | 700mA  
Total wattage: 45W  
Material: aluminium/acrylic

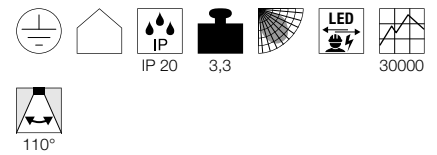

**Dimensional drawing**

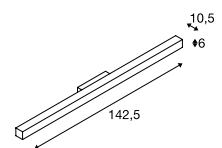

Variant	Item No.
3800lm   3000K   CRI>80 □ white	1000668
3800lm   3000K   CRI>80 ■ black	1000669
3800lm   3000K   CRI>80 ■ grey	1000670



1002066 271



1002067 271

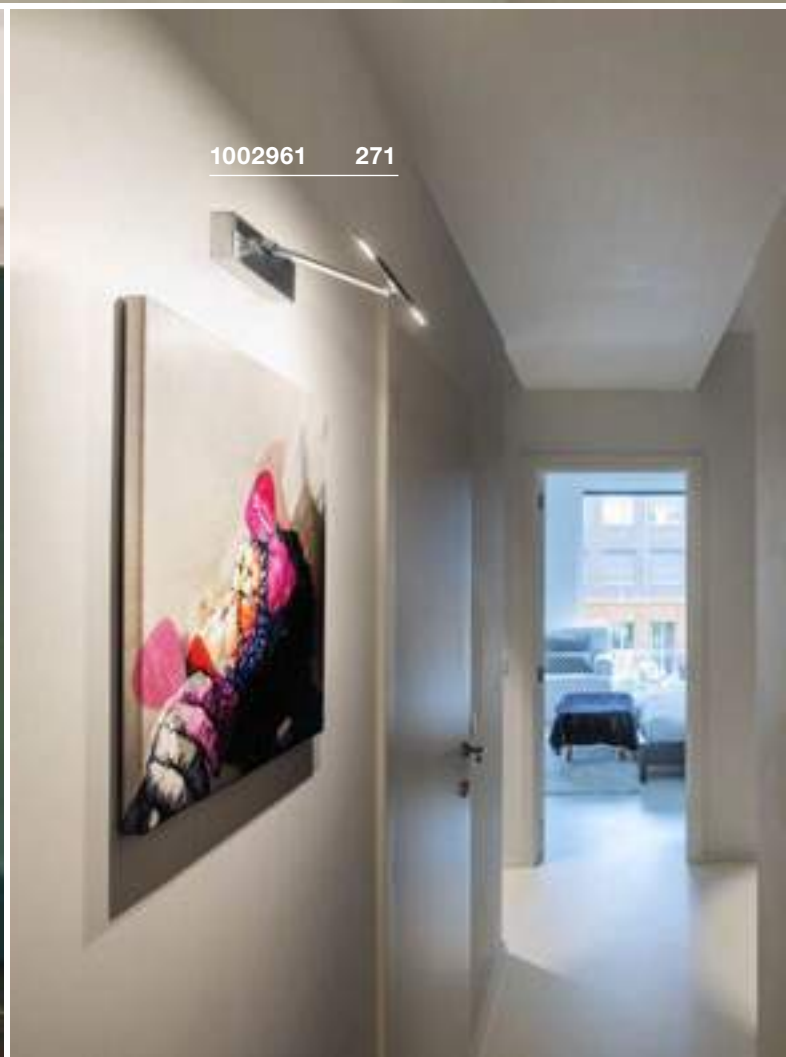

1002961 271

VINCELLI D  
WL, PHASE



- Slim design
- Light body made of real bamboo

Product details

220-240V ~50/60Hz | 350mA  
Total wattage: 11W  
Material: bamboo/steel  
Dimmable: C, L

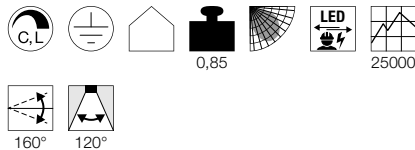

Dimensional drawing

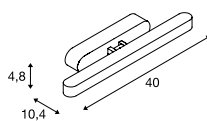

Variant	Item No.
500lm   2700K   CRI>80 ■ anthracite/brown	1002066

VINCELLI D  
WL, PHASE



- Slim design
- Light body made of real bamboo

Product details

220-240V ~50/60Hz | 350mA  
Total wattage: 11W  
Material: bamboo/steel  
Dimmable: C, L

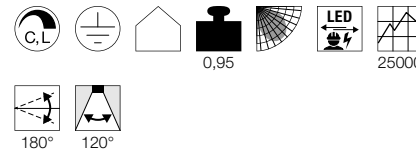

Dimensional drawing

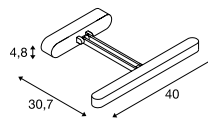

Variant	Item No.
500lm   2700K   CRI>80 ■ anthracite/brown	1002067

RETRATO  
WL, PHASE



- Rotating and pivoting light head

Product details

220-240V ~50/60Hz  
Total wattage: 12W  
Material: aluminium/steel  
Dimmable: C, L

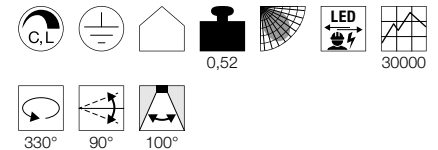

Dimensional drawing

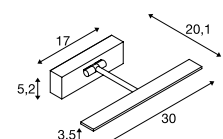

Variant	Item No.
730lm   3000K   CRI>90	
■ white/chrome	1002960
730lm   3000K   CRI>90	
■ chrome	1002961

**FILI, CLAMP**  
WL, QPAR51

SOCKET  
INSIDE



- Rotating and pivoting light head

**Product details**

230V -50Hz  
Material: aluminium/brass



**Dimensional drawing**

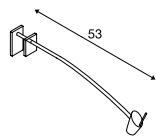

**Tip**

Clamping range max. 8 cm.

**Recommended lamp**

LED GU10 6W 36°  
3000K 460lm  
6kWh/1000h  
Item No. 1005078



LED GU10 4W 36°  
3000K 300lm  
4kWh/1000h  
Item No. 1004973



**Lamp details**

max. 50W QPAR51

Variant	Item No.
GU10   QPAR51	
■ grey	146452

1002860 225

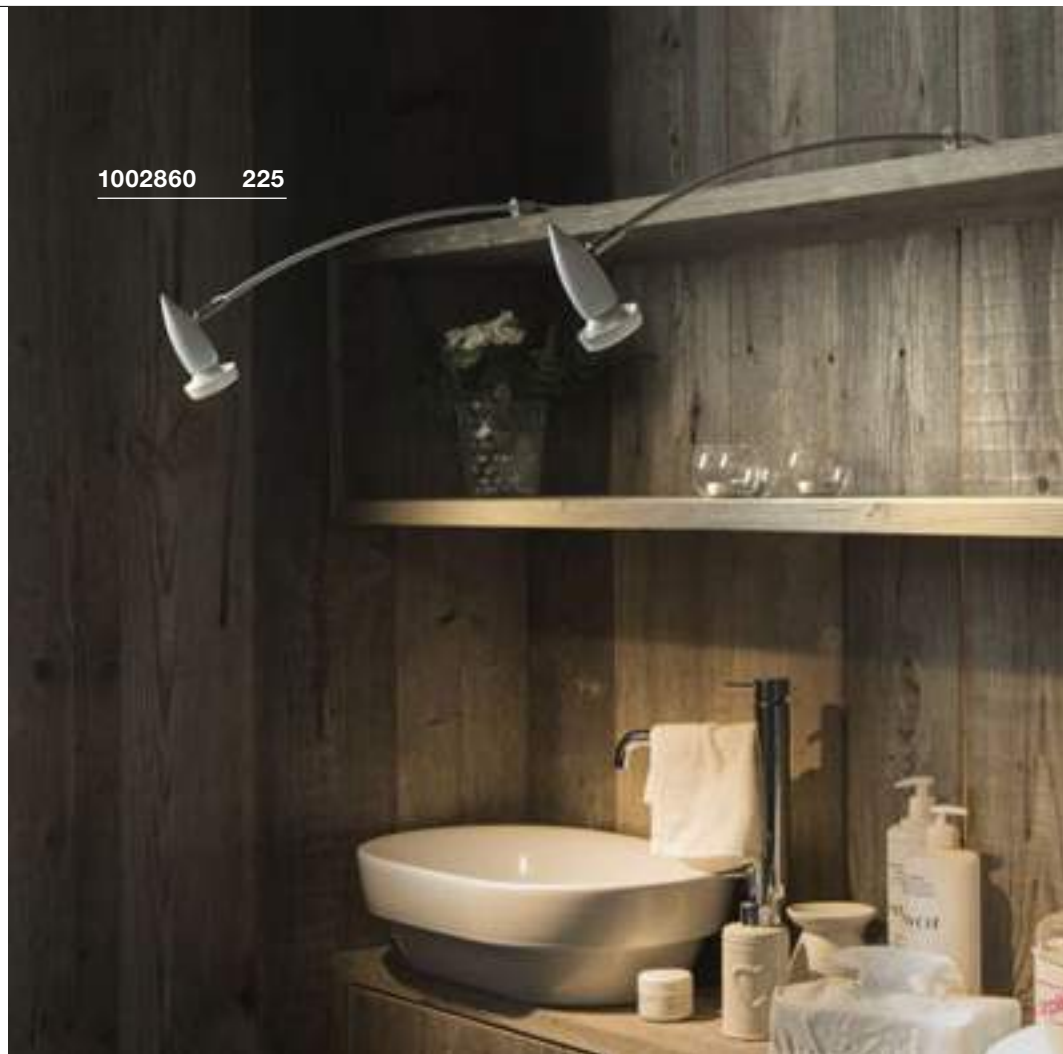

146452 224







DISPLAY ADL 50  
QPAR51

SOCKET  
INSIDE

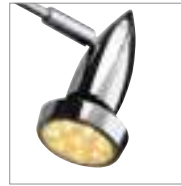
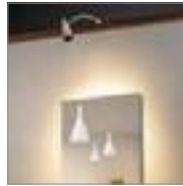

- Rotating and pivoting light head

Product details

220-240V ~50/60Hz  
Material: aluminium/brass



Dimensional drawing

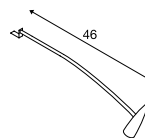

Accessory recommendation

- Lamp decorative ring diameter 5.7cm  
Item No. 151041
- Lamp decorative ring diameter 5.7cm  
Item No. 151049

Recommended lamp

- LED GU10 6W 36°  
3000K 460lm  
6kWh/1000h  
Item No. 1005079
- LED GU10 4W 36°  
3000K 300lm  
4kWh/1000h  
Item No. 1004973

Lamp details

max. 50W QPAR51

Variant	Item No.
GU10   QPAR51	
<input type="checkbox"/> white	1002860
GU10   QPAR51	
<input type="checkbox"/> chrome	146332

SPOT DISPLAY  
E27



SOCKET  
INSIDE

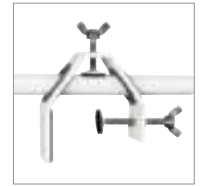

- Switch located on the power cord
- Robust

Product details

220-240V ~50/60Hz  
Material: aluminium/steel

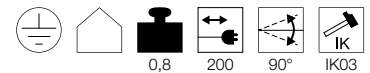

Dimensional drawing

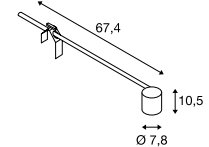

Tip

- Safety plug
- Clamping range: 10-60 mm

Recommended lamp

- LED E27 17W 45°  
3000K 1430lm  
17kWh/1000h  
Item No. 560473
- LED E27 8W 350°  
2200K 250lm  
8kWh/1000h  
Item No. 1003100

Lamp details

max. 18.5W

Variant	Item No.
E27	
<input type="checkbox"/> black	1002985
E27	
<input type="checkbox"/> white	1002986
E27	
<input type="checkbox"/> grey	1002987

1000734 275



1000746 + 1000748 191



1001009 275



1001464 275

ANELA  
Display

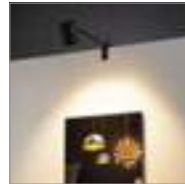

- Switch located on the power cord

Product details

220-240V ~50/60Hz  
Total wattage: 10W  
Material: aluminium  
Dimmable: C, L

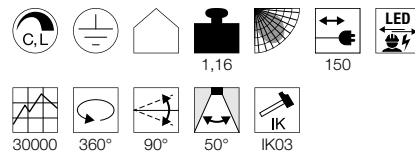

Dimensional drawing

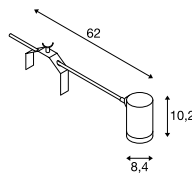

Tip

Euro plug  
Clamping range: 7-50 mm

LENITO  
WL



- Easy installation thanks to the screw clamp with wing nut

Product details

220-240V ~50/60Hz | 160mA  
Total wattage: 23W  
Material: aluminium/polycarbonate (PC)

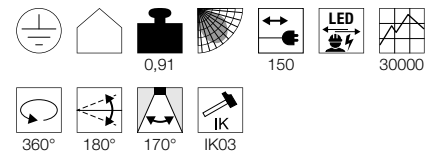

Dimensional drawing

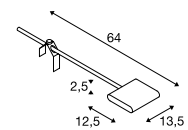

Tip

Safety plug and switch  
Clamping range: 10-45 mm

Variant	Item No.
750lm   3000K   CRI>80	
■ black	1000733
750lm   3000K   CRI>80	
□ white	1000734
750lm   4000K   CRI>80	
■ black	1001009
750lm   4000K   CRI>80	
□ white	1001010

Variant	Item No.
250lm · 3000K · CRI>80	
□ white	1001464
2350lm   3000K   CRI>80	
■ black	1001465

**MALO DISPLAY**  
WL



- Easy installation thanks to the screw clamp with wing nut

**Product details**

230V -50Hz  
Total wattage: 23W  
Material: aluminium

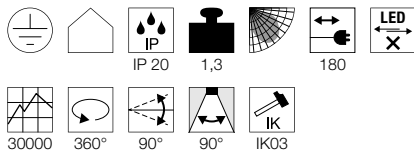

**Dimensional drawing**

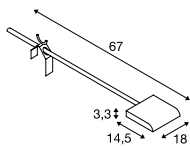

**Tip**

Euro plug and switch  
Clamping range: 15-55 mm

**NEPRO DISPLAY**  
QT-DE12



- Rotating and pivoting light head
- Easy installation thanks to the screw clamp with wing nut

**Product details**

230V -50Hz  
Material: aluminium

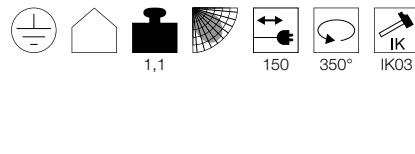

**Dimensional drawing**

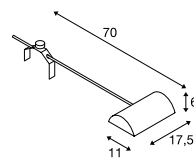

**Tip**

Safety plug and switch  
Clamping range: 15-55 mm

**Recommended lamp**

LED R7s 118mm 14W  
3000K 2000lm  
14kWh/1000h  
Item No. 1002135



**Lamp details**

max. 300W QT-DE12

Variant	Item No.
1600lm   4000K   CRI>80	
■ grey	1001857
1600lm   4000K   CRI>80	
■ white/chrome	1001858

Variant	Item No.
R7s 118mm   QT-DE12	
■ grey/chrome	146472





## DISPLAY

FOLLOW  
POWERLED  
INSIDE

## Product details

200-240V ~50/60Hz | 350mA  
 Total wattage: 13W  
 Material: aluminium/ABS

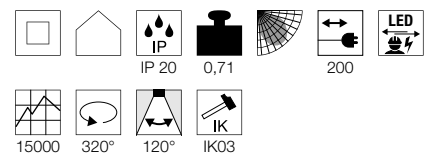

## Dimensional drawing

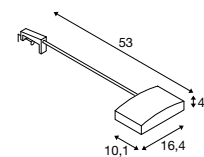

## Tip

Euro plug  
 Clamping range: 5-55 mm



Variant	Item No.
1350lm   4000K   CRI>80 <span style="display: inline-block; width: 10px; height: 10px; background-color: #cccccc; border: 1px solid #000;"></span> silver grey	1003492
1150lm   3000K   CRI>80 <span style="display: inline-block; width: 10px; height: 10px; background-color: #cccccc; border: 1px solid #000;"></span> silver grey	1003493

# THE BEST THINGS COME FROM ABOVE.

## CEILING LIGHTS FOR FLEXIBLE LIGHTING.

---

Ceiling lights are the centrepiece of any room. They bring a warm ambience into each space with their radiant power. Adapted to the room concept, you can align the luminaires in an optimum way and set impressive emphasis of light from above.





1001896 300

1001891 301

1001893 300

1001900 300















































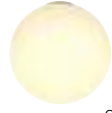





















148004

322



CEILING LIGHTS

							
282	283	283	283	284	285	285	286
							
286	288	288	288	289	289	294	295
							
296	296	296	297	298	299	299	299
							
300	300	300	301	302	303	304	305
							
305	305	306	307	308	308	308	311
							
311	312	312	313	313	314	315	315
							
315	316	316	317	317	319	319	319
							
321	321	321	322	323	323	324	324
							
325	325	325					

# SLV FENDA. MIX & MATCH.

MIX & MATCH

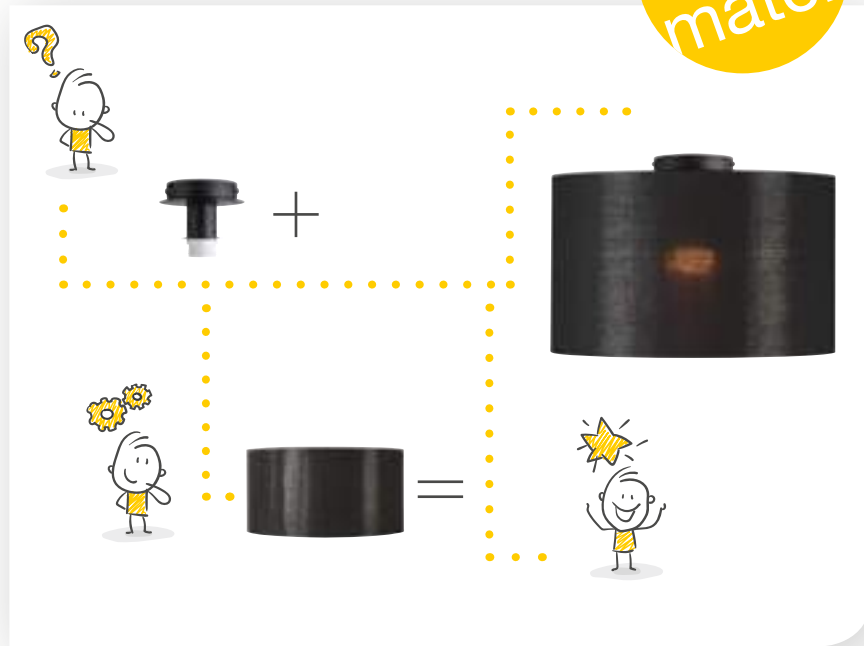

FENDA  
Ceiling rose, E27



SOCKET  
INSIDE



- Can be individually altered through the selection of a suitable lampshade

**Product details**

230V -50Hz  
Material: steel



0,3

**Dimensional drawing**

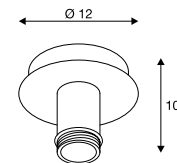

**Recommended lamp**

LED E27 14.5W 200°  
2700K 1521lm  
15kWh/1000h  
Item No. 560422



LED E27 7W 330°  
2700K 806lm  
8kWh/1000h  
Item No. 1001038



**Lamp details**

max. 60W

Variant	Item No.
E27	
■ black	155550
E27	
□ white	155551
E27	
■ chrome	155552



155552 + 156122

282

FENDA  
Diameter 30 cm, round



- Can be individually altered through the selection of a suitable light base

Product details

Material: textile/steel



Dimensional drawing

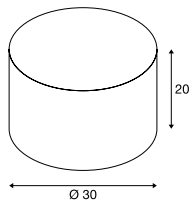

Tip

max. 60W  
Acrylic glass cover (155570) to close the shade on one side available as accessory.

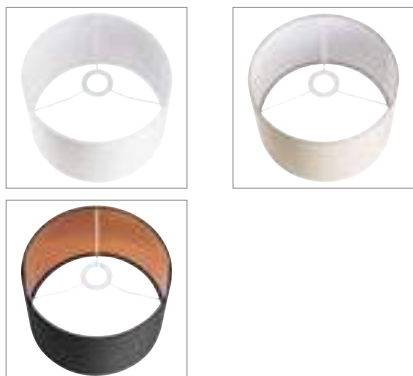

Accessory recommendation

Acrylic glass cover  
Item No. 155570

Variant	Item No.
<input type="checkbox"/> white	155582
<input type="checkbox"/> beige	155583
<input type="checkbox"/> black/copper	155592

FENDA  
Diameter 45 cm, round



- Can be individually altered through the selection of a suitable light base

Product details

Material: textile/steel



Dimensional drawing

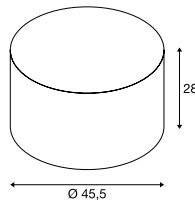

Tip

max. 60W  
Acrylic glass cover (156100) to close the shade on one side available as accessory.

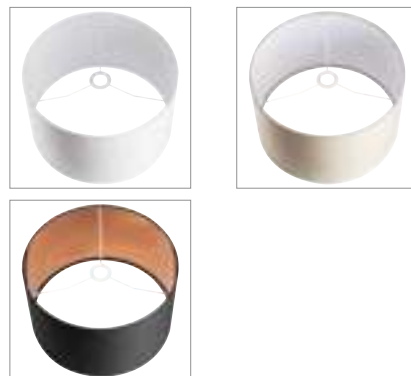

Accessory recommendation

Acrylic glass cover  
Item No. 156100

Variant	Item No.
<input type="checkbox"/> white	156111
<input type="checkbox"/> beige	156113
<input type="checkbox"/> black/copper	156122

FENDA  
Diameter 70 cm, round



- Can be individually altered through the selection of a suitable light base

Product details

Material: textile/steel



Dimensional drawing

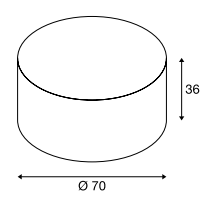

Tip

max. 60W  
Acrylic glass cover (1000957) to close the shade on one side available as accessory.



Accessory recommendation

Acrylic glass cover  
Item No. 1000957

Variant	Item No.
<input type="checkbox"/> white	1000579
<input checked="" type="checkbox"/> black/copper	1000580

ACCANTO  
CL, E27SOCKET  
INSIDE

1002945 284



- Acrylic cover at the bottom of the shade

## Product details

220-240V ~50/60Hz  
Material: steel/textile



## Dimensional drawing

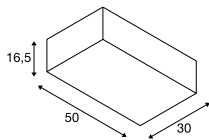

## Recommended lamp

LED E27 9.1W 240°  
2700K 760lm  
10kWh/1000h  
Item No. 560402



LED E27 7W  
2700K 810lm  
7kWh/1000h  
Item No. 1003090



## Lamp details

2x max. 40W

Variant	Item No.
E27	
■ black	1002945
□ white	1002945





156050 285

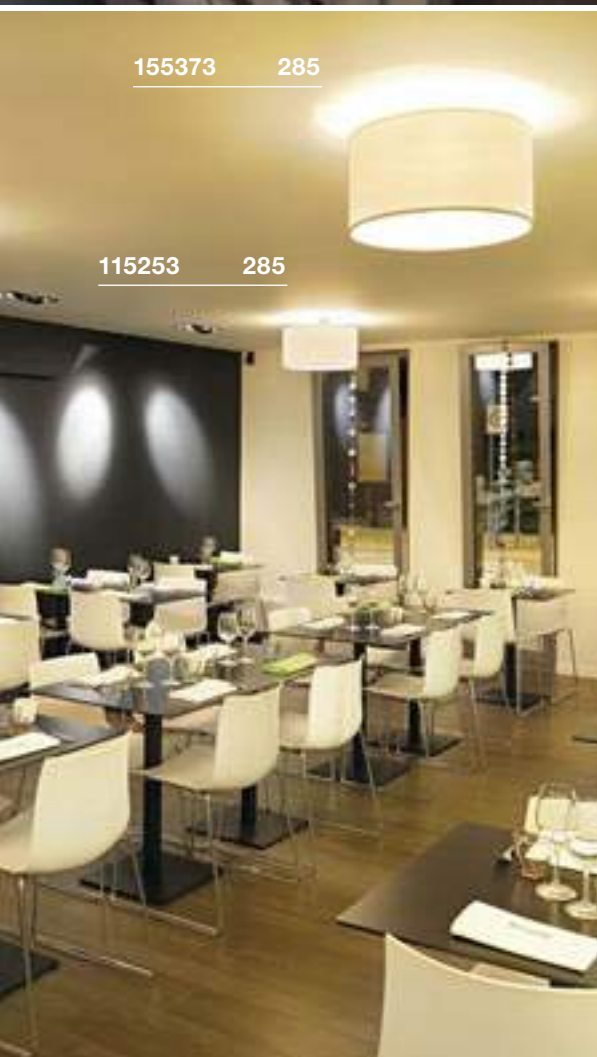

155373 285

115253 285

TENORA  
CL, E27



SOCKET  
INSIDE



Product details

230V -50Hz  
Material: steel/textile



1,4

Dimensional drawing

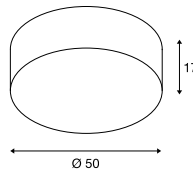

Tip

Rose: diameter 12cm

Recommended lamp

LED E27 9.1W 240°  
2700K 760lm  
10kWh/1000h  
Item No. 560402



LED E27 7W  
2700K 810lm  
7kWh/1000h  
Item No. 1003090



Lamp details

3x max. 23W  
L: 14.8 cm max.

Variant	Item No.
E27	
■ black	156050
E27	
□ white	156051

SOPRANA  
CL, E27



SOCKET  
INSIDE



Product details

230V -50Hz  
Material: steel/textile

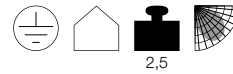

2,5

Dimensional drawing

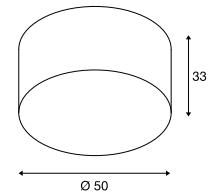

Tip

Rose: diameter 15cm

Recommended lamp

LED E27 14.5W 200°  
2700K 1521lm  
15kWh/1000h  
Item No. 560422



LED E27 7W 280°  
2200-2700K 830lm  
7kWh/1000h  
Item No. 1002126



Lamp details

3x max. 60W  
L: 20 cm max.

Variant	Item No.
E27	
□ white	155372
E27	
■ beige	155373

BATO 45  
CW, E27



BATO 45  
CW, PHASE



SOCKET  
INSIDE



LED  
INSIDE



Product details

220-240V ~50/60Hz  
Material: aluminium/steel



Product details

220-240V ~50/60Hz | 700mA  
Total wattage: 30W  
Material: aluminium/polymethylacrylate (PMMA)  
Dimmable: C

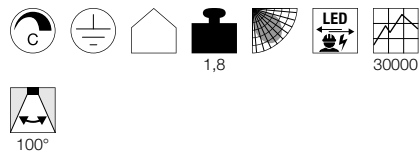

Dimensional drawing

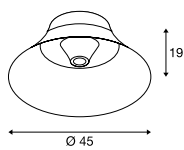

Dimensional drawing

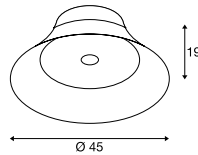

Recommended lamp

LED E27 4W 180°  
2000-2900K 200lm  
4kWh/1000h  
Item No. 1003098



LED E27 7W  
2700K 640lm  
7kWh/1000h  
Item No. 1003085



Lamp details

max. 60W

Variant	Item No.
E27	
■ matt black	1000443
E27	
■ matt copper	1000445

Variant	Item No.
1450lm   2700K   CRI>80	
■ matt black	1000437
1900lm   2500K   CRI>80	
■ matt copper	1000442

1000442 286



1000443 286





1000442 286



PLASTRA  
CL, PHASE



- Can be individually designed with colours, stickers & more

Product details

220-240V ~50/60Hz | 350mA  
Total wattage: 15W  
Material: gypsum/steel  
Dimmable: C, L

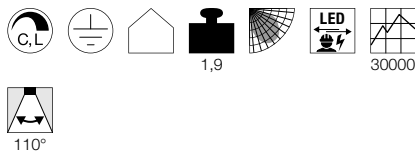

Dimensional drawing

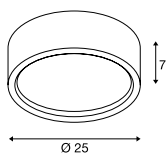

PLASTRA 105  
CL, E27



- Can be individually designed with colours, stickers & more

Product details

220-240V ~50/60Hz  
Material: gypsum/glass



Dimensional drawing

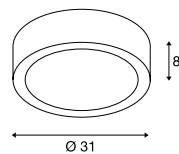

Recommended lamp

LED E27 9W 240°  
3000K 810lm  
10kWh/1000h  
Item No. 1001031



LED E27 9W 240°  
4000K 850lm  
9kWh/1000h  
Item No. 1002827



Lamp details

2x max. 25W  
Diameter: 5 cm max. L: 14 cm max.

Variant	Item No.
990lm   3000K   CRI>80 <input type="checkbox"/> matt white	148005

PLASTRA 104  
CL, E27

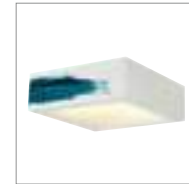

- Can be individually designed with colours, stickers & more

Product details

220-240V ~50/60Hz  
Material: gypsum/glass



Dimensional drawing

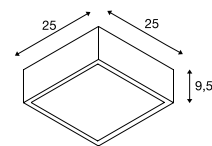

Recommended lamp

LED E27 9W 240°  
3000K 810lm  
10kWh/1000h  
Item No. 1001031



LED E27 9W 240°  
4000K 850lm  
9kWh/1000h  
Item No. 1002827



Lamp details

2x max. 25W  
Diameter: 5 cm max. L: 14 cm max.

Variant	Item No.
E27 <input type="checkbox"/> matt white	148002





1002968 289



1001939 289

**FERA 25**  
CL, DALI



- The light colour can be selected during installation using a switch

**Product details**

220-240V ~50/60Hz | 500mA  
 Total wattage: 19.5W  
 Material: polycarbonate (PC)/polymethacrylate  
 Dimmable: Dali

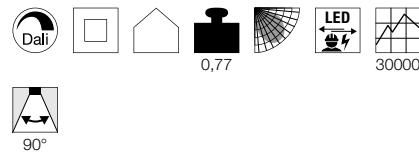

**Dimensional drawing**

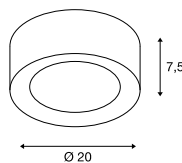

**FERA 25**  
CL



**Product details**

100-240V ~50/60Hz | 550mA  
 Total wattage: 21W  
 Material: aluminium/polystyrene (PS)

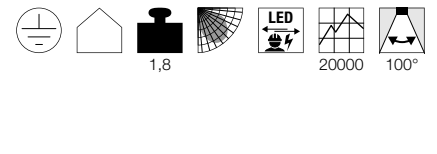

**Dimensional drawing**

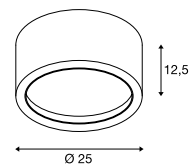



Variant	Item No.
1580/1650lm   3000/4000K   CRI>80	
■ matt black	<b>1002968</b>
1580/1650lm   3000/4000K   CRI>80	
□ matt white	<b>1002967</b>

Variant	Item No.
2000lm   3000K   CRI>80	
■ black	<b>1001939</b>
2000lm   3000K   CRI>80	
□ white	<b>161461</b>
2000lm   3000K   CRI>80	
■ grey	<b>161464</b>

# MEDO LIGHTING SERIES.

## CEILING OR PENDANT LIGHTS.

	MEDO 30 CL, 1-10V	MEDO 40 CL, 1-10V	MEDO 60 CL, 1-10V	MEDO 90 CL, 1-10V
Example				
Lightbulb				
Size	Diameter: 30 cm	Diameter: 40 cm	Diameter: 60 cm	Diameter: 90 cm
Light strength	1000lm	2000lm	3500lm	11000lm
UGR	25	25	22	25
Dimmable	1-10V	1-10V	1-10V	1-10V
Suspension kit	1.5 m   5 m	1.5 m   5 m	1.5 m   5 m	1.5 m   5 m

	MEDO 30 CL, PHASE	MEDO 40 CL, PHASE	
Example			
Lightbulb			
Size-diameter	Diameter: 30 cm	Diameter: 40 cm	
Light strength	1200lm	2125lm	
UGR	25	25	
Dimmable	C, L	C, L	
Suspension set (not included)	1.5 m   5 m	1.5 m   5 m	

	MEDO 60 CL, square, 1-10V	MEDO 60 CL, square, DALI
Example		
Lightbulb		
Size	W   L: 60 cm	W   L: 60 cm
Light strength	3300 lm	3300 lm
UGR	22	22
Dimmable	1-10V	
Suspension kit	1.5 m   5 m	1.5 m   5 m



# MEDO LIGHTING SERIES.

## CEILING OR PENDANT LIGHTS.

	MEDO 30 AMBIENT CW, PHASE	MEDO 40 AMBIENT CW, PHASE	MEDO 60 AMBIENT CW, PHASE	MEDO 90 AMBIENT CL, PHASE
Example				
Lightbulb				
Size	Diameter: 30 cm	Diameter: 40 cm	Diameter: 60 cm	Diameter: 90 cm
Light strength	Down: 1230/1280lm Up: 20lm	Down: 2750/2900lm Up: 50lm	Down: 4350/4750lm Up: 120lm	Down: 9500/10100lm Up: 125lm
UGR	25	25	25	25
Dimmable	C	C	C	C
Suspension kit	1.5 m   5 m	1.5 m   5 m	1.5 m   5 m	1.5 m   5 m

	MEDO 30 AMBIENT CW, DALI	MEDO 40 AMBIENT CW, DALI	MEDO 60 AMBIENT CW, DALI	MEDO 90 AMBIENT CL, DALI
Example				
Lightbulb				
Size	Diameter: 30 cm	Diameter: 40 cm	Diameter: 60 cm	Diameter: 90 cm
Light strength	Down: 1230/1280lm Up: 20lm	Down: 2750/2900lm Up: 50lm	Down: 4350/4750lm Up: 120lm	Down: 9500/10100lm Up: 125lm
UGR	25	25	25	25
Dimmable				
Suspension kit	1.5 m   5 m	1.5 m   5 m	1.5 m   5 m	1.5 m   5 m

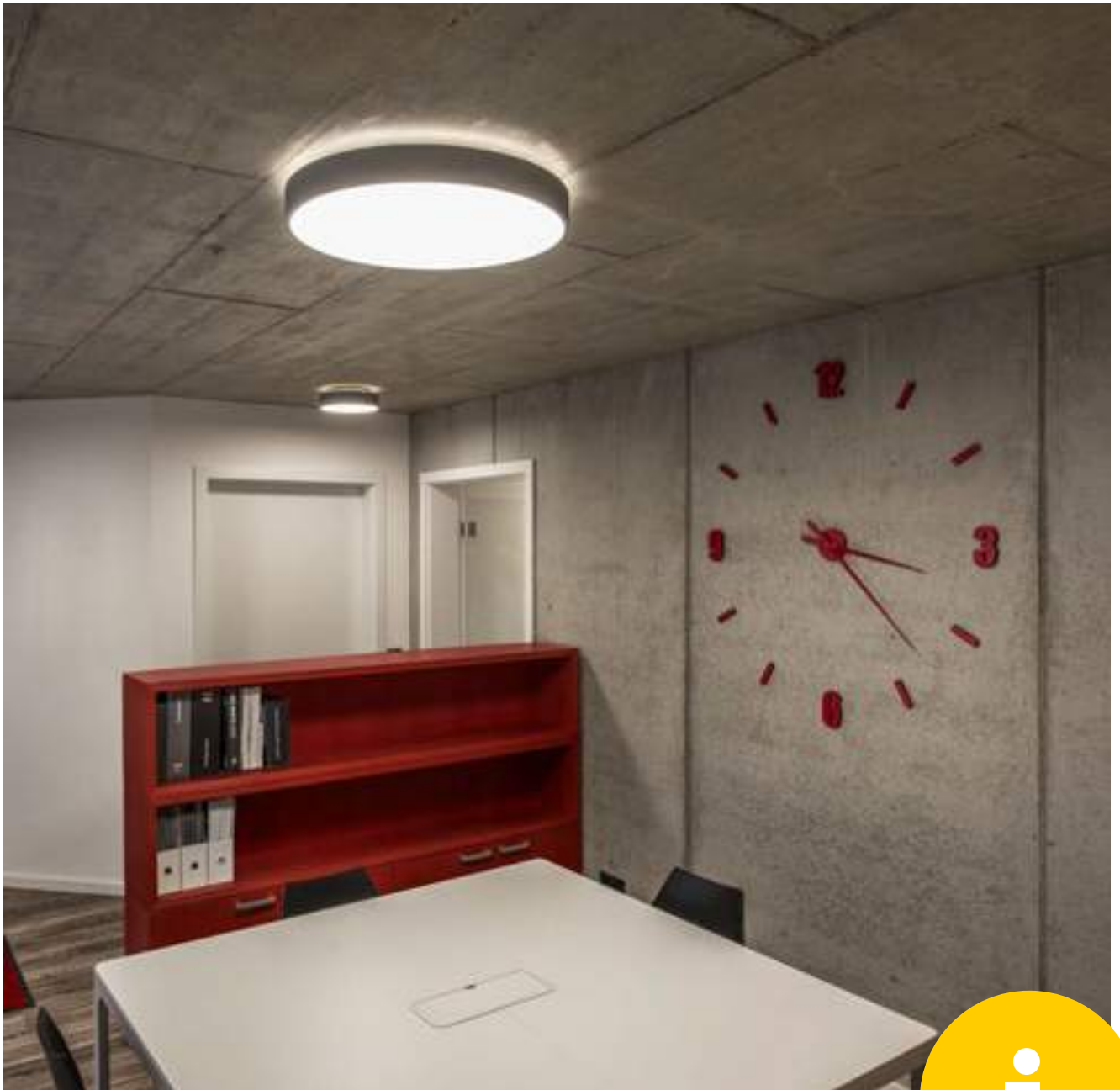

**Ambient effect** - These MEDO variants produce even and indirect light in an upwards direction.



**Colour temperature** - With this MEDO variant, you can select the colour temperature yourself. The switch on the reverse can be used to choose between 3000k and 4000k.

MEDO 30  
CL, PHASE



135070 295



135250 294



135120 296

135020 294

Product details

220-240V ~50/60Hz | 350mA  
Total wattage: 16W  
Material: aluminium/polymethylacrylate (PMMA)  
Dimmable: C, L

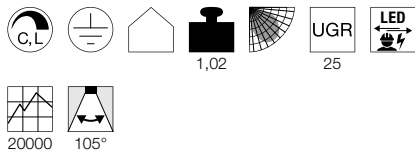

Dimensional drawing

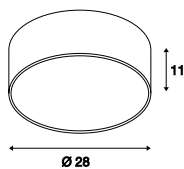

Tip

Suspension set not included

Accessory recommendation

- Suspension kit 1.5m  
Item No. 135250
- Suspension kit 1.5m  
Item No. 135251
- Suspension kit 1.5m  
Item No. 135254
- Suspension kit 5m  
Item No. 1001950
- Suspension kit 5m  
Item No. 1001951
- Suspension kit 5m  
Item No. 1001952

Variant	Item No.
1200lm   3000K   CRI>80	
<input checked="" type="checkbox"/> black	135020
1200lm   3000K   CRI>80	
<input type="checkbox"/> white	135021
1200lm   3000K   CRI>80	
<input checked="" type="checkbox"/> grey	135024



135071 295

MEDO 40  
CL, PHASE



Product details

220-240V ~50/60Hz | 700mA

Total wattage: 31W

Material: aluminium/polymethylacrylate (PMMA)

Dimmable: C, L



1,75

25



20000

105°

Dimensional drawing

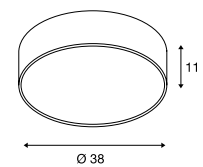

Tip

Suspension set not included

Accessory recommendation

■ Suspension kit 1.5m

Item No. 135250



□ Suspension kit 1.5m

Item No. 135251



■ Suspension kit 1.5m

Item No. 135254



□ Suspension kit 5m

Item No. 1001950



■ Suspension kit 5m

Item No. 1001951



■ Suspension kit 5m

Item No. 1001952



Variant	Item No.
2125lm   3000K   CRI>80	
■ black	135070
2125lm   3000K   CRI>80	
□ white	135071
2125lm   3000K   CRI>80	
■ grey	135074

MEDO 30  
CL, 1-10V



Product details

220-240V ~50/60Hz | 350mA  
Total wattage: 15W  
Material: aluminium/polymethylacrylate (PMMA)  
Dimmable: 1-10V

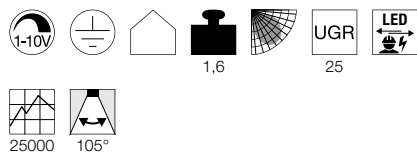

Dimensional drawing

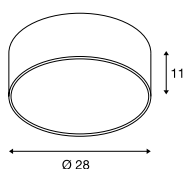

Tip

Suspension set not included

Accessory recommendation

- Suspension kit 1.5m  
Item No. 135250
- Suspension kit 1.5m  
Item No. 135251
- Suspension kit 1.5m  
Item No. 135254
- 1-10V dimming  
Item No. 470505
- Suspension kit 5m  
Item No. 1001950
- Suspension kit 5m  
Item No. 1001951
- Suspension kit 5m  
Item No. 1001952

Variant	Item No.
1000lm   3000K   CRI>80	
■ black	1000855
1000lm   3000K   CRI>80	
□ white	1000856
1000lm   3000K   CRI>80	
■ grey	1000857

MEDO 40  
CL, 1-10V



Product details

120-240V ~50/60Hz | 700mA  
Total wattage: 29W  
Material: aluminium/polymethylacrylate (PMMA)  
Dimmable: 1-10V

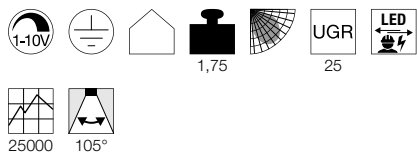

Dimensional drawing

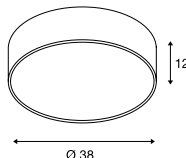

Tip

Suspension set not included

Accessory recommendation

- Suspension kit 1.5m  
Item No. 135250
- Suspension kit 1.5m  
Item No. 135251
- Suspension kit 1.5m  
Item No. 135254
- 1-10V dimming  
Item No. 470505
- Suspension kit 5m  
Item No. 1001950
- Suspension kit 5m  
Item No. 1001951
- Suspension kit 5m  
Item No. 1001952

Variant	Item No.
2000lm   3000K   CRI>80	
■ black	1000864
2000lm   3000K   CRI>80	
□ white	1000865
2000lm   3000K   CRI>80	
■ grey	1000866

MEDO 60  
CL, 1-10V



Product details

100-240V ~50/60Hz | 1000mA  
Total wattage: 40W  
Material: aluminium/polymethylacrylate (PMMA)  
Dimmable: 1-10V

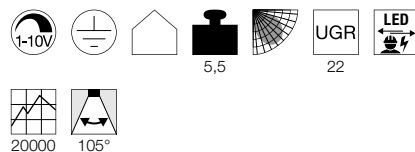

Dimensional drawing

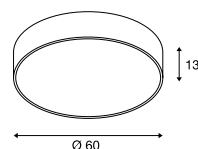

Tip

Suspension set not included

Accessory recommendation

- Suspension kit 1.5m  
Item No. 135250
- Suspension kit 1.5m  
Item No. 135251
- Suspension kit 1.5m  
Item No. 135254
- 1-10V dimming  
Item No. 470505
- Suspension kit 5m  
Item No. 1001950
- Suspension kit 5m  
Item No. 1001951
- Suspension kit 5m  
Item No. 1001952

Variant	Item No.
3500lm   3000K   CRI>80	
■ black	135120
3500lm   3000K   CRI>80	
□ white	135121
3500lm   3000K   CRI>80	
■ grey	135124





135121 292



135021 296

135171 297

135121 296



MEDO 90  
CL, 1-10V



Product details

220-240V ~50/60Hz | 2900mA  
Total wattage: 119W  
Material: aluminium/polymethylacrylate (PMMA)  
Dimmable: 1-10V

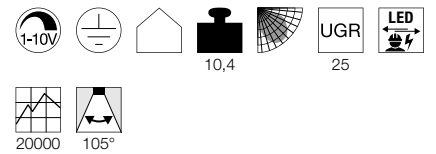

Dimensional drawing

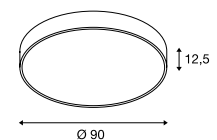

Tip

Suspension set not included

Accessory recommendation

- Suspension kit 1.5m  
Item No. 135250
- Suspension kit 1.5m  
Item No. 135251
- Suspension kit 1.5m  
Item No. 135254
- 1-10V dimming  
Item No. 470505
- Suspension kit 5m  
Item No. 1001950
- Suspension kit 5m  
Item No. 1001951
- Suspension kit 5m  
Item No. 1001952

Variant	Item No.
11000lm   3000K   CRI>80	
■ black	135170
11000lm   3000K   CRI>80	
□ white	135171
11000lm   3000K   CRI>80	
■ grey	135174

MEDO 30 AMBIENT  
CW, PHASE



- Colour temperature (3000K/4000K) can be adjusted using the switch

Product details

220-240V ~50/60Hz | 350mA  
 Total wattage: 15W  
 Material: aluminium/polycarbonate (PC)  
 Dimmable: C

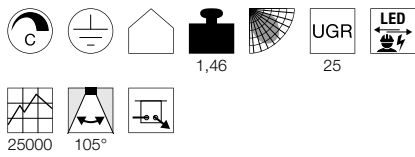

Dimensional drawing

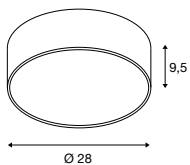

Tip

Suspension set not included

Accessory recommendation

- Suspension kit 1.5m  
Item No. 135250
- Suspension kit 1.5m  
Item No. 135251
- Suspension kit 1.5m  
Item No. 135254
- Suspension kit 5m  
Item No. 1001950
- Suspension kit 5m  
Item No. 1001951
- Suspension kit 5m  
Item No. 1001952

Variant	Item No.
Down: 1230/1280lm   3000/4000K   CRI>80 Up: 20lm   3000/4000K   CRI>80	
<input checked="" type="checkbox"/> black	1001877
Down: 1230/1280lm   3000/4000K   CRI>80 Up: 20lm   3000/4000K   CRI>80	
<input type="checkbox"/> white	1001881
Down: 1230/1280lm   3000/4000K   CRI>80 Up: 20lm   3000/4000K   CRI>80	
<input checked="" type="checkbox"/> grey	1001882

1001878 299



1001886 299

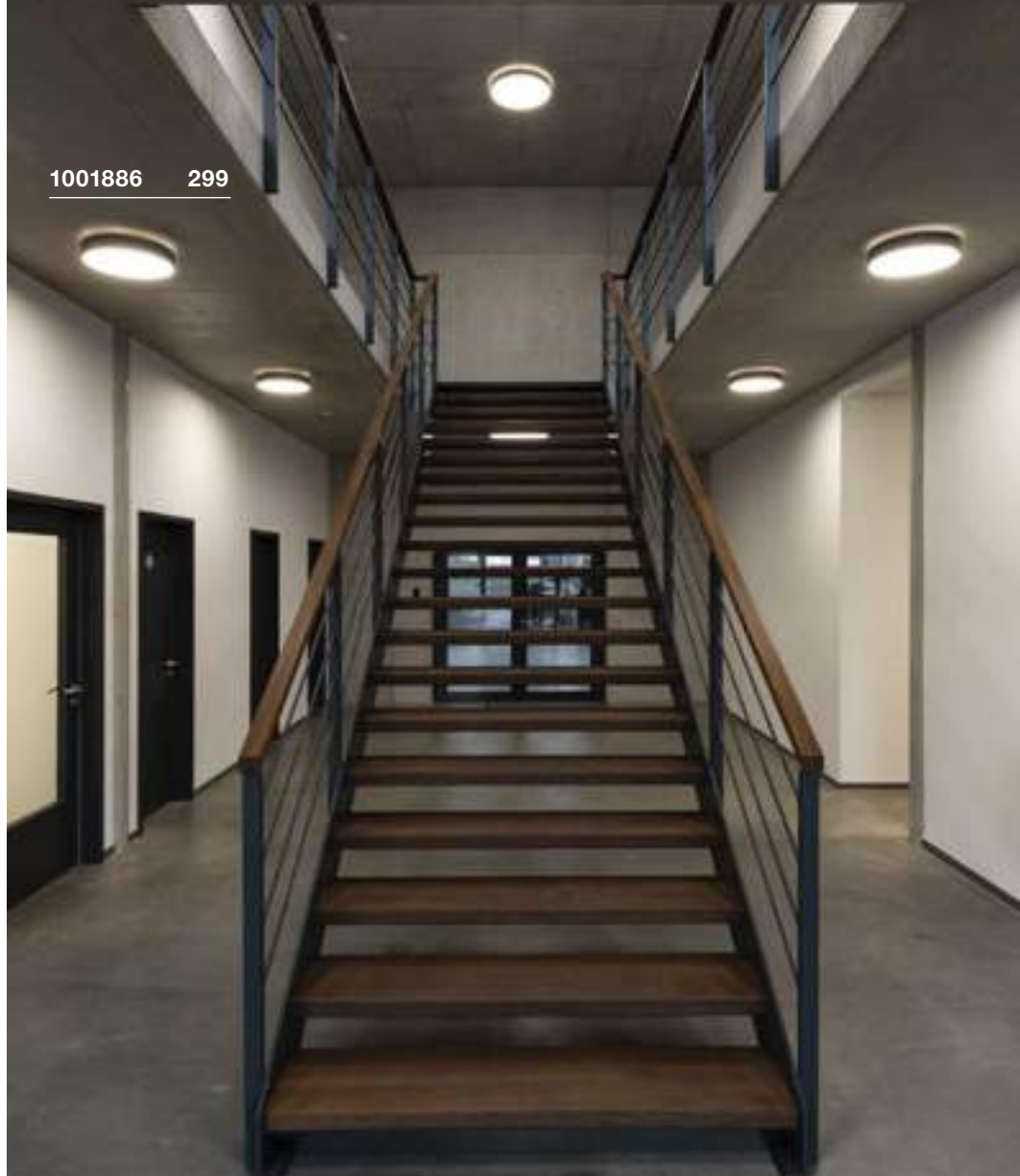

MEDO 40 AMBIENT  
CW, PHASE

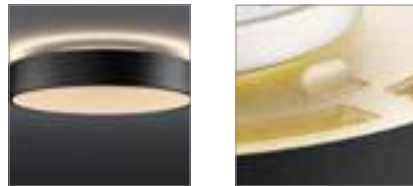

- Colour temperature (3000K/4000K) can be adjusted using the switch

Product details

220-240V ~50/60Hz | 700mA  
Total wattage: 30W  
Material: aluminium/polycarbonate (PC)  
Dimmable: C

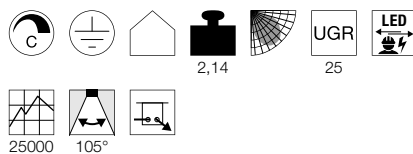

Dimensional drawing

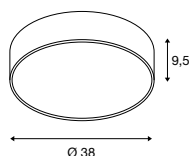

Tip

Suspension set not included

Accessory recommendation

- Suspension kit 1.5m  
Item No. 135250
- Suspension kit 1.5m  
Item No. 135251
- Suspension kit 1.5m  
Item No. 135254
- Suspension kit 5m  
Item No. 1001950
- Suspension kit 5m  
Item No. 1001951
- Suspension kit 5m  
Item No. 1001952

Variant	Item No.
Down: 2750/2900lm   3000/4000K   CRI>80 Up: 50lm   3000/4000K   CRI>80	
■ black	1001883
Down: 2750/2900lm   3000/4000K   CRI>80 Up: 50lm   3000/4000K   CRI>80	
□ white	1001884
Down: 2750/2900lm   3000/4000K   CRI>80 Up: 50lm   3000/4000K   CRI>80	
■ grey	1001885

MEDO 60 AMBIENT  
CW, PHASE



- Colour temperature (3000K/4000K) can be adjusted using the switch

Product details

220-240V ~50/60Hz | 1050mA  
Total wattage: 40W  
Material: aluminium/polycarbonate (PC)  
Dimmable: C

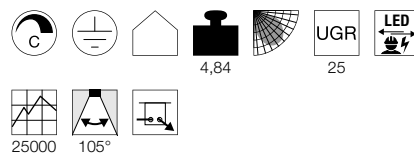

Dimensional drawing

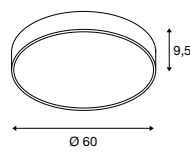

Tip

Suspension set not included

Accessory recommendation

- Suspension kit 1.5m  
Item No. 135250
- Suspension kit 1.5m  
Item No. 135251
- Suspension kit 1.5m  
Item No. 135254
- Suspension kit 5m  
Item No. 1001950
- Suspension kit 5m  
Item No. 1001951
- Suspension kit 5m  
Item No. 1001952

Variant	Item No.
Down: 4350/4750lm   3000/4000K   CRI>80 Up: 120lm   3000/4000K   CRI>80	
■ black	1001886
Down: 4350/4750lm   3000/4000K   CRI>80 Up: 120lm   3000/4000K   CRI>80	
□ white	1001887
Down: 4350/4750lm   3000/4000K   CRI>80 Up: 120lm   3000/4000K   CRI>80	
■ grey	1001888

MEDO 90 AMBIENT  
CL, PHASE

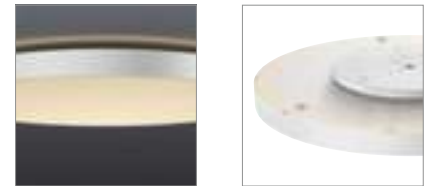

- Colour temperature (3000K/4000K) can be adjusted using the switch

Product details

220-240V ~50/60Hz | 1050mA  
Total wattage: 78W  
Material: aluminium/polycarbonate (PC)  
Dimmable: C

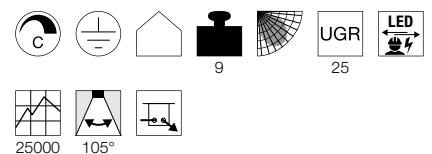

Dimensional drawing

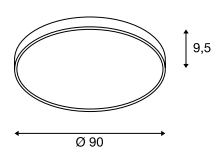

Tip

Suspension set not included

Accessory recommendation

- Suspension kit 1.5m  
Item No. 135250
- Suspension kit 1.5m  
Item No. 135251
- Suspension kit 1.5m  
Item No. 135254
- Suspension kit 5m  
Item No. 1001950
- Suspension kit 5m  
Item No. 1001951
- Suspension kit 5m  
Item No. 1001952

Variant	Item No.
Down: 9500/10100lm   3000/4000K   CRI>80 Up: 125lm   3000/4000K   CRI>80	
■ black	1001878
Down: 9500/10100lm   3000/4000K   CRI>80 Up: 125lm   3000/4000K   CRI>80	
□ white	1001879
Down: 9500/10100lm   3000/4000K   CRI>80 Up: 125lm   3000/4000K   CRI>80	
■ grey	1001880

MEDO 30 AMBIENT  
CW, DALI



• Colour temperature (3000K/4000K) can be adjusted using the switch

Product details

220-240V ~50/60Hz | 350mA  
Total wattage: 15W  
Material: aluminium/polycarbonate (PC)  
Dimmable: Dali

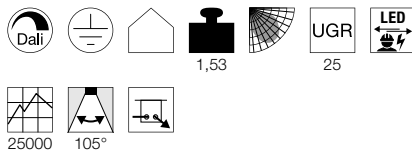

Dimensional drawing

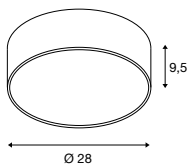

Tip

Suspension set not included

Accessory recommendation

- Suspension kit 1.5m  
Item No. 135250
- Suspension kit 1.5m  
Item No. 135251
- Suspension kit 1.5m  
Item No. 135254
- Suspension kit 5m  
Item No. 1001950
- Suspension kit 5m  
Item No. 1001951
- Suspension kit 5m  
Item No. 1001952

Variant	Item No.
Down: 1230/1280lm   3000/4000K   CRI>80 Up: 20lm   3000/4000K   CRI>80	
■ black	1001889
Down: 1230/1280lm   3000/4000K   CRI>80 Up: 20lm   3000/4000K   CRI>80	
□ white	1001893
Down: 1230/1280lm   3000/4000K   CRI>80 Up: 20lm   3000/4000K   CRI>80	
■ grey	1001894

MEDO 40 AMBIENT  
CW, DALI



• Colour temperature (3000K/4000K) can be adjusted using the switch

Product details

220-240V ~50/60Hz | 700mA  
Total wattage: 30W  
Material: aluminium/polycarbonate (PC)  
Dimmable: Dali

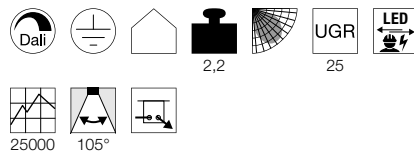

Dimensional drawing

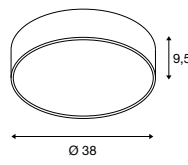

Tip

Suspension set not included

Accessory recommendation

- Suspension kit 1.5m  
Item No. 135250
- Suspension kit 1.5m  
Item No. 135251
- Suspension kit 1.5m  
Item No. 135254
- Suspension kit 5m  
Item No. 1001950
- Suspension kit 5m  
Item No. 1001951
- Suspension kit 5m  
Item No. 1001952

Variant	Item No.
Down: 2750/2900lm   3000/4000K   CRI>80 Up: 50lm   3000/4000K   CRI>80	
■ black	1001895
Down: 2750/2900lm   3000/4000K   CRI>80 Up: 50lm   3000/4000K   CRI>80	
□ white	1001896
Down: 2750/2900lm   3000/4000K   CRI>80 Up: 50lm   3000/4000K   CRI>80	
■ grey	1001897

MEDO 60 AMBIENT  
CW, DALI



• Colour temperature (3000K/4000K) can be adjusted using the switch

Product details

220-240V ~50/60Hz | 1000mA  
Total wattage: 40W  
Material: aluminium/polycarbonate (PC)  
Dimmable: Dali

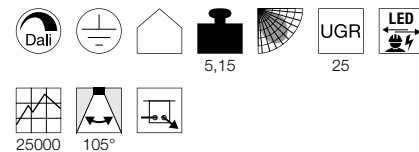

Dimensional drawing

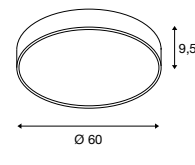

Tip

Suspension set not included

Accessory recommendation

- Suspension kit 1.5m  
Item No. 135250
- Suspension kit 1.5m  
Item No. 135251
- Suspension kit 1.5m  
Item No. 135254
- Suspension kit 5m  
Item No. 1001950
- Suspension kit 5m  
Item No. 1001951
- Suspension kit 5m  
Item No. 1001952

Variant	Item No.
Down: 4350/4750lm   3000/4000K   CRI>80 Up: 120lm   3000/4000K   CRI>80	
■ black	1001898
Down: 4350/4750lm   3000/4000K   CRI>80 Up: 120lm   3000/4000K   CRI>80	
□ white	1001900
Down: 4350/4750lm   3000/4000K   CRI>80 Up: 120lm   3000/4000K   CRI>80	
■ grey	1001899

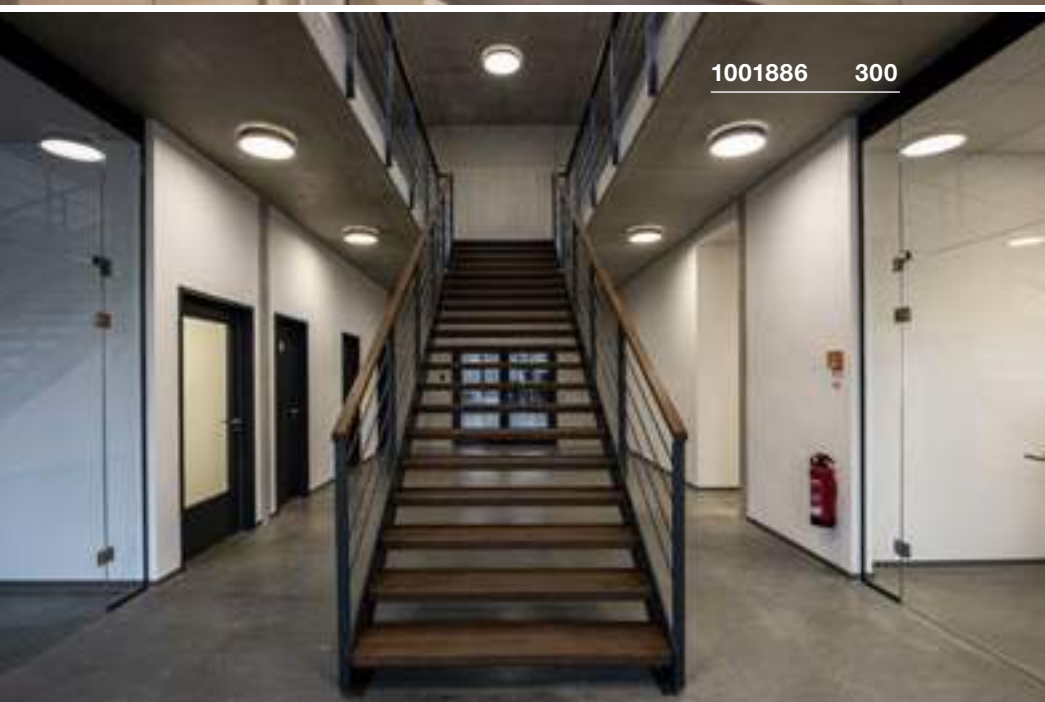
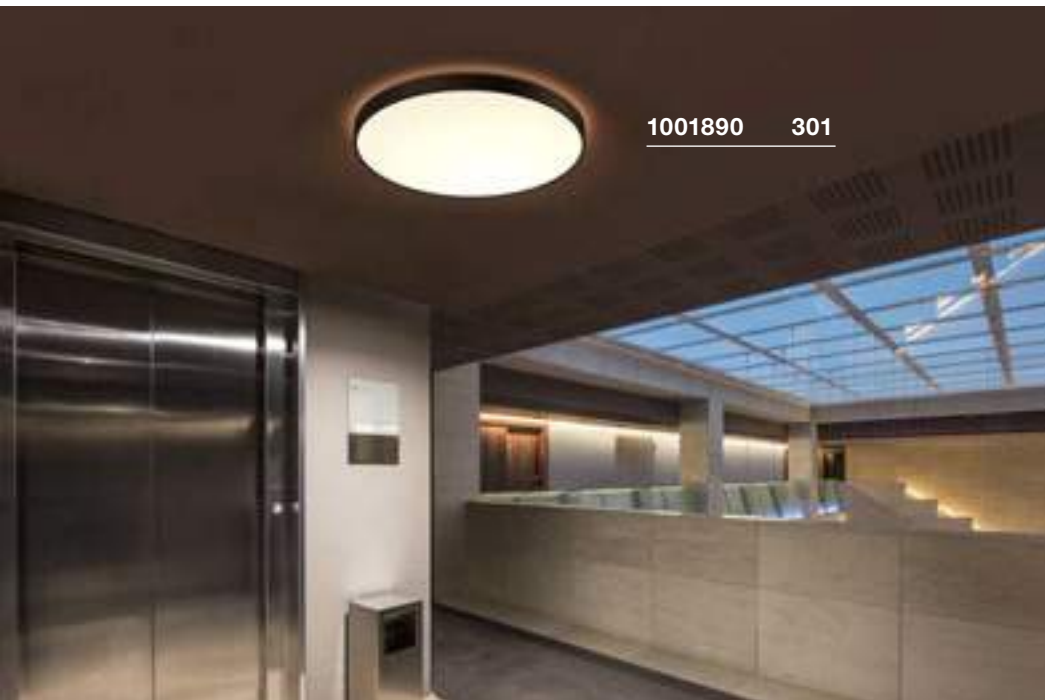

MEDO 90 AMBIENT CL, DALI

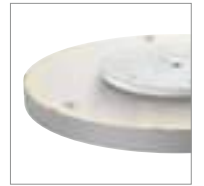

- Colour temperature (3000K/4000K) can be adjusted using the switch

Product details

220-240V ~50/60Hz | 1000mA  
 Total wattage: 78W  
 Material: aluminium/polycarbonate (PC)  
 Dimmable: Dali



9,1

25



25000

105°

Dimensional drawing

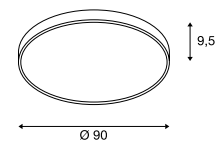

Tip

Suspension set not included

Accessory recommendation

- Suspension kit 1.5m  
Item No. 135250
- Suspension kit 1.5m  
Item No. 135251
- Suspension kit 1.5m  
Item No. 135254
- Suspension kit 5m  
Item No. 1001950
- Suspension kit 5m  
Item No. 1001951
- Suspension kit 5m  
Item No. 1001952

Variant	Item No.
Down: 9500/10100lm   3000/4000K   CRI>80 Up: 125lm   3000/4000K   CRI>80	■ black 1001890
Down: 9500/10100lm   3000/4000K   CRI>80 Up: 125lm   3000/4000K   CRI>80	□ white 1001891
Down: 9500/10100lm   3000/4000K   CRI>80 Up: 125lm   3000/4000K   CRI>80	■ grey 1001892

MEDO 60  
CL, square



1000725 302



Product details

100-240V ~50/60Hz | 1000mA  
Systemleistung: 39W  
Material: aluminium/acrylic  
Dimmable: 1-10V

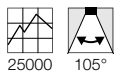

Dimensional drawing

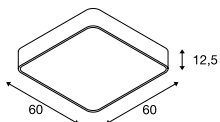

Tip

Suspension set not included

Accessory recommendation

- Suspension kit 1.5m  
Item No. 135250
- Suspension kit 1.5m  
Item No. 135251
- Suspension kit 1.5m  
Item No. 135254
- 1-10V dimming  
Item No. 470505
- Suspension kit 5m  
Item No. 1001950
- Suspension kit 5m  
Item No. 1001951
- Suspension kit 5m  
Item No. 1001952

Variant	Item No.
3300lm   3000K   CRI>80 <input checked="" type="checkbox"/> black	1000725
3300lm   3000K   CRI>80 <input type="checkbox"/> white	1000726
3300lm   3000K   CRI>80 <input checked="" type="checkbox"/> grey	1000727





1002822 303

MEDO 60  
CL, square, DALI



Product details

100-277V ~50/60Hz | 1000mA  
Systemleistung: 39W  
Material: aluminium/acrylic  
Dimmable: Dali

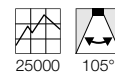
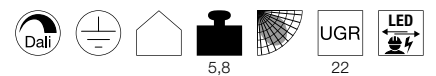

Dimensional drawing

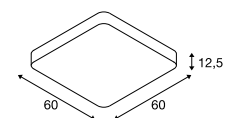

Accessory recommendation

- Suspension kit 1.5m  
Item No. 135250
- Suspension kit 1.5m  
Item No. 135251
- Suspension kit 1.5m  
Item No. 135254
- Suspension kit 5m  
Item No. 1001950
- Suspension kit 5m  
Item No. 1001951
- Suspension kit 5m  
Item No. 1001952

Variant	Item No.
3300lm   3000K   CRI>80 <input type="checkbox"/> white	1002882

PANEL 60  
CL, round, PHASE

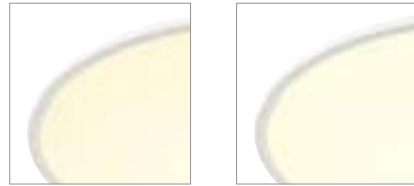

- Assembly or partial installation of the panel possible

Product details

220-240V ~50/60Hz | 1000mA  
 Total wattage: 42W  
 Material: aluminium/polymethylacrylate (PMMA)  
 Installation dimensions:  
 Assembly diameter: 20 cm T: 7 cm  
 Dimmable: C

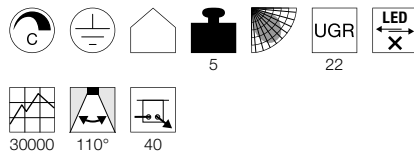

Dimensional drawing

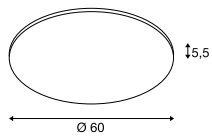

Variant	Item No.
3150lm   3000K   CRI>80 white	1000783
3350lm   4000K   CRI>80 white	1000784
3150lm   3000K   CRI>80 grey	1000785
3350lm   4000K   CRI>80 grey	1000786

1000783 304

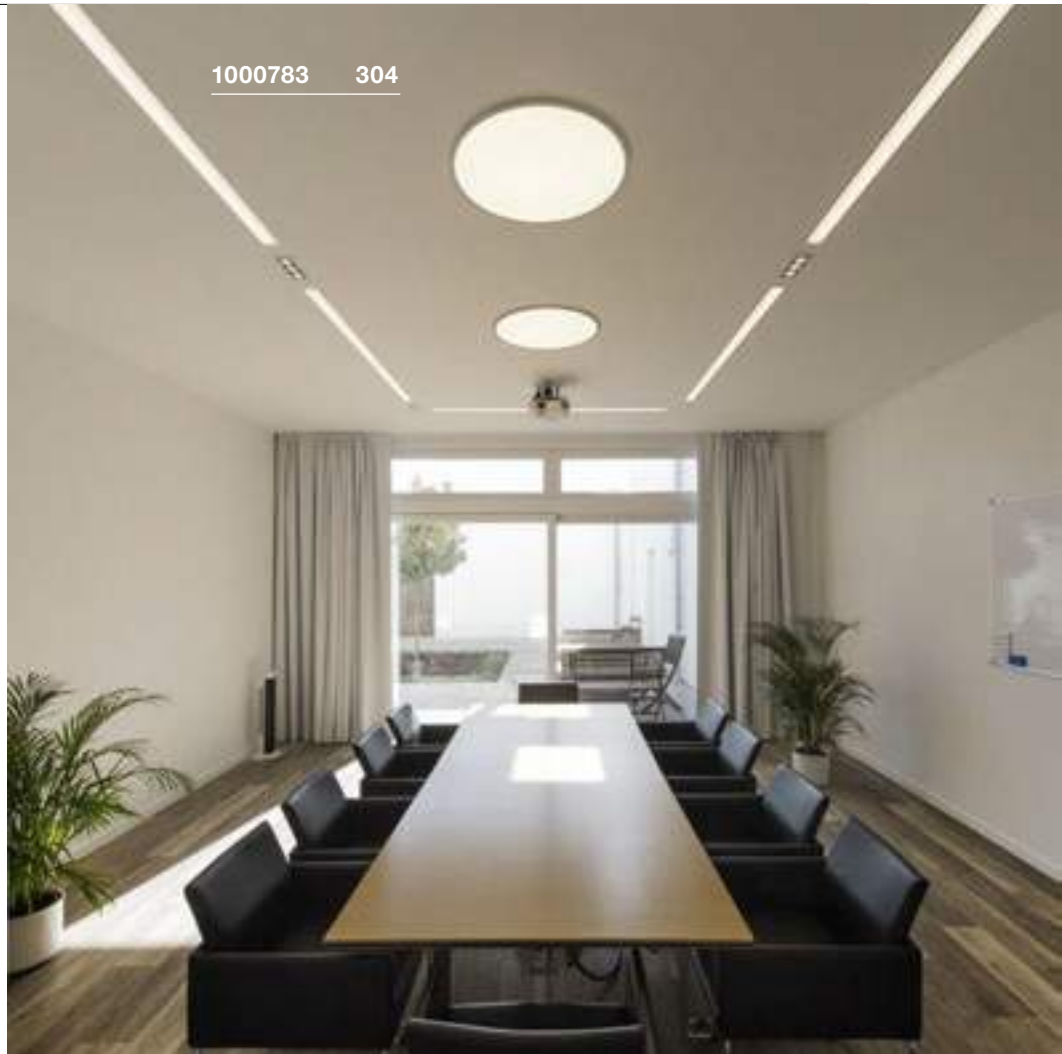

1000785 304





**PANEL 60**  
CL, round, DALI



- Assembly or partial installation of the panel possible

**Product details**

100-277V ~50/60Hz | 1000mA  
 Total wattage: 42W  
 Material: aluminium/polymethylacrylate (PMMA)  
 Installation dimensions:  
 Assembly diameter: 20 cm T: 7 cm  
 Dimmable: Dali

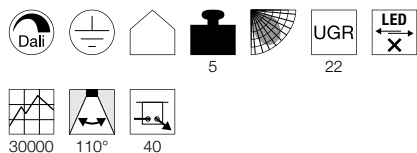

**Dimensional drawing**

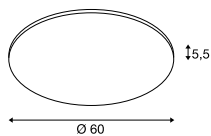

**PANEL**  
CL, 1200x300mm, PHASE

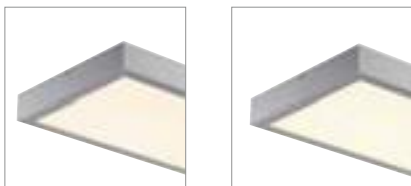

- UGR<19
- Suitable for screen-based workstations in line with EN 12464-1

**Product details**

220-240V ~50/60Hz | 1000mA  
 Total wattage: 45W  
 Material: aluminium/polymethylacrylate (PMMA)  
 Dimmable: C

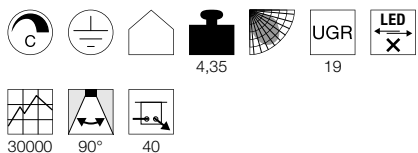

**Dimensional drawing**

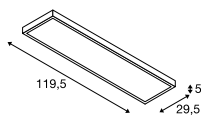

**PANEL**  
CL, 1200x300mm, DALI

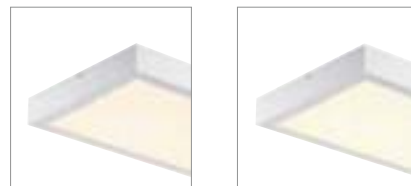

- UGR<19
- Suitable for screen-based workstations in line with EN 12464-1

**Product details**

100-277V ~50/60Hz | 1000mA  
 Total wattage: 45W  
 Material: aluminium/polymethylacrylate (PMMA)  
 Dimmable: Dali

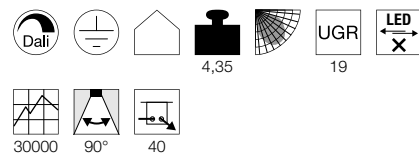

**Dimensional drawing**

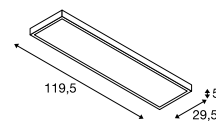

Variant	Item No.
3150lm   3000K   CRI>80 □ white	1003040
3350lm   4000K   CRI>80 □ white	1003041
3150lm   3000K   CRI>80 ■ grey	1003042
3350lm   4000K   CRI>80 ■ grey	1003043

Variant	Item No.
3100lm   3000K   CRI>80 □ white	1001505
3400lm   4000K   CRI>80 □ white	1001506
3100lm   3000K   CRI>80 ■ grey	1001508
3400lm   4000K   CRI>80 ■ grey	1001509

Variant	Item No.
3100lm   3000K   CRI>80 □ white	1003052
3400lm   4000K   CRI>80 □ white	1003053
3100lm   3000K   CRI>80 ■ grey	1003054
3400lm   4000K   CRI>80 ■ grey	1003055

Q-LINE®  
CL, 1m, BAP, PHASE



1000689 306



- Premium LED with CRI>90

Product details

220-240V ~50/60Hz | 900mA  
Total wattage: 45W  
Material: aluminium/plastic  
Dimmable: L

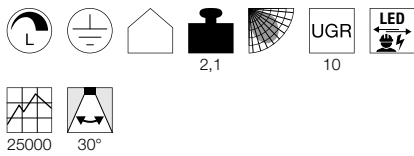

Dimensional drawing

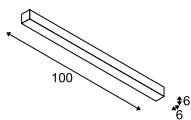

Variant	Item No.
2100lm   3000K   CRI>90 white	1000685
2100lm   3000K   CRI>90 black	1000686
2100lm   3000K   CRI>90 grey	1000687 ▼
2300lm   4000K   CRI>90 white	1000688
2300lm   4000K   CRI>90 black	1000689
2300lm   4000K   CRI>90 grey	1000690 ▼





1000692 307

Q-LINE®  
CL, 2m, BAP, PHASE



- Premium LED with CRI>90

Product details

220-240V ~50/60Hz | 900mA  
Total wattage: 85W  
Material: aluminium/plastic  
Dimmable: L

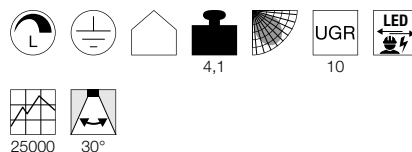

Dimensional drawing

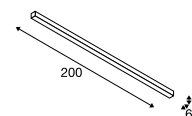

Variant	Item No.
4200lm   3000K   CRI>90 ■ white	1000691
4200lm   3000K   CRI>90 ■ black	1000692
4200lm   3000K   CRI>90 ■ grey	1000693 ▼
4600lm   4000K   CRI>90 ■ white	1000694
4600lm   4000K   CRI>90 ■ black	1000695
4600lm   4000K   CRI>90 ■ grey	1000696 ▼

**ROTOBALL 25**  
CL, E27



**ROTOBALL 40**  
CL, E27



**MALANG**  
CL, E27

SOCKET  
INSIDE



SOCKET  
INSIDE



SOCKET  
INSIDE

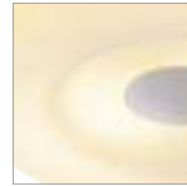

**Product details**

230V -50Hz  
Material: steel/polyethylene (PE)



1,85

**Product details**

230V -50Hz  
Material: steel/polyethylene (PE)



1,85

**Product details**

230V -50Hz  
Material: steel/glass

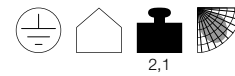

2,1

**Dimensional drawing**

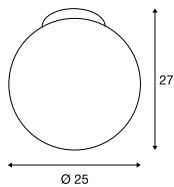

**Dimensional drawing**

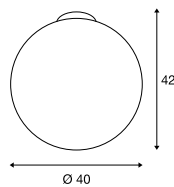

**Dimensional drawing**

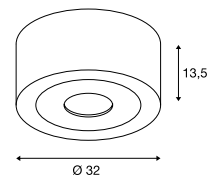

**Recommended lamp**

LED E27 9.1W 240°  
2700K 760lm  
10kWh/1000h  
Item No. 560402



**Recommended lamp**

LED E27 14.5W 200°  
2700K 1521lm  
15kWh/1000h  
Item No. 560422



**Recommended lamp**

LED E27 9W 240°  
3000K 810lm  
10kWh/1000h  
Item No. 1001031



LED E27 7W  
2700K 810lm  
7kWh/1000h  
Item No. 1003090



LED E27 15W 240°  
4000K 1600lm  
15kWh/1000h  
Item No. 1002828



LED E27 9W 240°  
4000K 850lm  
9kWh/1000h  
Item No. 1002827



**Lamp details**

max. 24 W  
Diameter: 9.5 cm max.

**Lamp details**

max. 24 W  
Diameter: 9.5 cm max.

**Lamp details**

2x max. 60W  
Diameter: 5.5 cm max. L: 13.5 cm max.

Variant	Item No.
E27	
<input type="checkbox"/> white	1002051

Variant	Item No.
E27	
<input type="checkbox"/> white	1002052

Variant	Item No.
E27	
<input type="checkbox"/> white	146942



117321 311

**DESIGNED BY**  
David Morgan

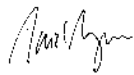

“Excellent light quality from innovative, distinctive and attractive luminaire designs.”



117351 311

OCCULDAS 13  
DL, Indirect, PHASE



OCCULDAS 23  
DL, Indirect, PHASE



- Indirect, glare-free lighting

- Indirect, glare-free lighting

Product details

220-240V ~50/60Hz | 350mA  
Total wattage: 15W  
Material: aluminium  
Dimmable: C

Product details

200-240V ~50/60Hz | 700mA  
Total wattage: 26W  
Material: aluminium/steel  
Dimmable: C, L

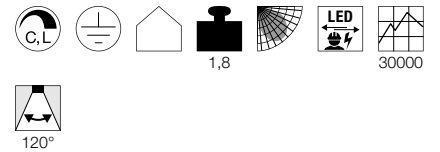
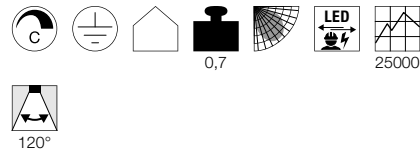

Dimensional drawing

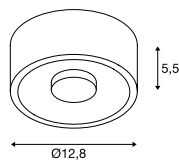

Dimensional drawing

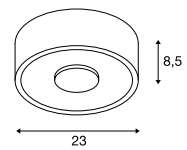

Variant	Item No.
810lm   3000K   CRI>80 □ matt white	117351

Variant	Item No.
1500lm   3000K   CRI>80 □ matt white	117321

ASTINA  
CL, QPAR51



SOCKET  
INSIDE



- High-quality, satin-finish glass

Product details

220-240V ~50/60Hz  
Material: aluminium



Dimensional drawing

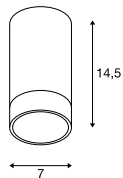

Recommended lamp

LED 6W 36°  
2700K 460lm  
6kWh/1000h  
Item No. 1005075



LED GU10 6W 36°  
3000K 460lm  
6kWh/1000h  
Item No. 1005079



Lamp details

max. 10W QPAR51

Variant	Item No.
GU10   QPAR51 □ matt white	1002934
GU10   QPAR51 ■ matt grey	1002935
GU10   QPAR51 ■ matt black	1002936

NAGY 75  
CL, QPAR51

SOCKET  
INSIDE



- Can be individually designed with colours, stickers & more

Product details

220-240V ~50/60Hz  
Material: gypsum



Dimensional drawing

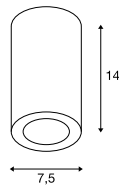

Recommended lamp

LED GU10 4W 36°  
2700K 300lm  
4kWh/1000h  
Item No. 1004972



LED GU10 4W 36°  
3000K 300lm  
4kWh/1000h  
Item No. 1004973



Lamp details

max. 10W QPAR51

Variant	Item No.
GU10   QPAR51 □ matt white	1002965

1002965 312



1002935 312

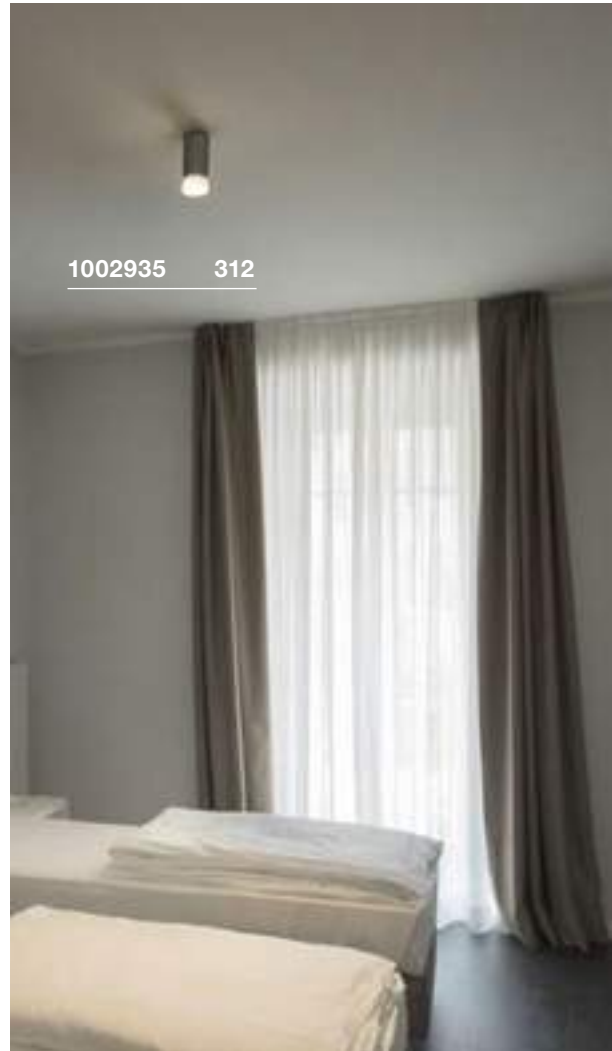





1000808 + 1000811 313



151810 313

**ENOLA B**  
CL, QPAR51



**SOCKET**  
INSIDE



**ANELA**  
CL, PHASE



**LED**  
INSIDE



- Premium LED with CRI>90
- Reduced glare
- Colourful reflectors available as accessories

**Product details**

220-240V ~50/60Hz  
Material: aluminium/steel



**Dimensional drawing**

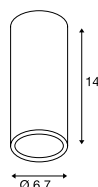

**Accessory recommendation**

■ Decorative ring  
Item No. 151840



**Recommended lamp**

LED GU10 6W 36°  
4000K 460lm  
6kWh/1000h  
Item No. 1005082



LED GU10 4W 36°  
4000K 300lm  
4kWh/1000h  
Item No. 1004974



**Lamp details**

max. 35W QPAR51  
L: 8.5 cm max.

Variant	Item No.
GU10   QPAR51	
■ black	151810
GU10   QPAR51	
□ white	151811
GU10   QPAR51	
■ gold	151813
GU10   QPAR51	
■ grey/black	151814

**Product details**

220-240V ~50/60Hz | 500mA  
Total wattage: 11W  
Material: aluminium  
Dimmable: C



**Dimensional drawing**

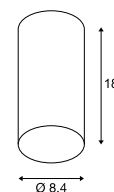

**Tip**

Luminous flux with reflector 1000809 = 500lm  
Luminous flux with reflector 1000810 = 620lm  
Luminous flux with reflector 1000811 = 200lm  
Luminous flux with reflector 1000812 = 620lm

**Accessory recommendation**

■ Reflector 28°  
Item No. 1000809  
■ Reflector 28°  
Item No. 1000810  
■ Reflector 28°  
Item No. 1000811  
□ Reflector 28°  
Item No. 1000812



Variant	Item No.
200-620lm   3000K   CRI>90	
■ black	1000807
200-620lm   3000K   CRI>90	
□ white	1000808



**Reflector 28°** - replace the reflector of this light to enjoy a different light effect thanks to the different colours (gold, grey, black and white).

ROX  
CL, QPAR111

1004666 315

SOCKET  
INSIDE

- High-quality brushed surface

## Product details

230V -50Hz  
Material: aluminium/glass



IP 44 0,8

## Dimensional drawing

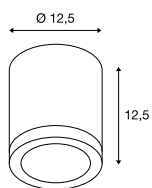

## Recommended lamp

LED GU10 7,9W 25°  
2700K 730lm  
8kWh/1000h  
Item No. 560702



LED GU10 7W 25°  
3000K 730lm  
8kWh/1000h  
Item No. 1001570



## Lamp details

max. 50W QPAR111

Variant	Item No.
GU10   QPAR111	
brushed aluminium	1000332



OCULUS  
CL, PHASE



NEW

LED  
INSIDE

DIM TO  
WARM



ENOLA C  
CL, PHASE



LED  
INSIDE

DIM TO  
WARM



ENOLA C  
CL



LED  
INSIDE



- Premium LED with CRI>90
- Dim to Warm
- The light colour alters when dimmed

Product details

220-240V ~50/60Hz | 250mA  
Total wattage: 10.5W  
Material: aluminium/glass  
Dimmable: C

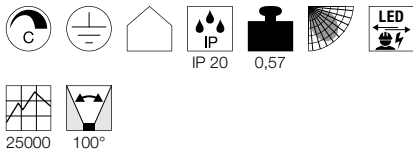

Dimensional drawing

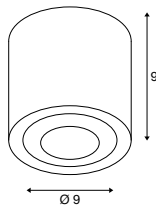

Product details

220-240V ~50/60Hz | 350mA  
Total wattage: 15W  
Material: aluminium/glass  
Dimmable: C

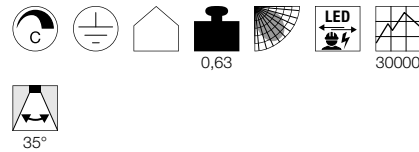

Dimensional drawing

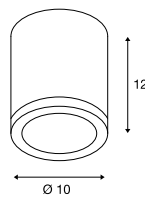

Product details

100-240V ~50/60Hz | 500mA  
Total wattage: 12W  
Material: aluminium/glass



Dimensional drawing

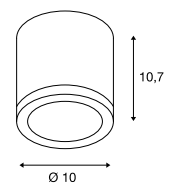

Variant	Item No.
36-780lm   2000-3000K   CRI>90	
■ matt black	1004666
36-780lm   2000-3000K   CRI>90	
□ matt white	1004667

Variant	Item No.
900lm   2000-3000K   CRI>90	
□ white	1000631

Variant	Item No.
850lm   3000K   CRI>80	
□ white	152101

ALTRA DICE  
CL, QPAR51



SOCKET  
INSIDE



Product details

220-240V ~50/60Hz  
Material: aluminium/steel



Dimensional drawing

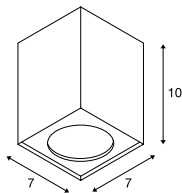

Recommended lamp

LED 6W 36°  
2700K 460lm  
6kWh/1000h  
Item No. 1005075



LED GU10 5.5W 38°  
2700K 400lm  
6kWh/1000h  
Item No. 1001030



Lamp details

max. 35W QPAR51

Variant	Item No.
GU10   QPAR51 □ white	151511
GU10   QPAR51 ■ grey/black	151514
GU10   QPAR51 ■ black	1002216

ALTRA DICE  
CW, double, QPAR51



SOCKET  
INSIDE



• Light completely pivotable

Product details

220-240V ~50/60Hz  
Material: aluminium/steel



Dimensional drawing

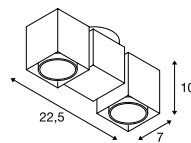

Recommended lamp

LED 6W 36°  
2700K 460lm  
6kWh/1000h  
Item No. 1005075



LED GU10 4W 36°  
3000K 300lm  
4kWh/1000h  
Item No. 1004973



Lamp details

2x max. 50W QPAR51

Variant	Item No.
GU10   QPAR51 □ white	151531
GU10   QPAR51 ■ grey/black	151534
GU10   QPAR51 ■ black	1002215



1001426 317



**TEC KALU**  
CL, double, PHASE

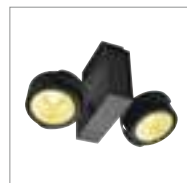

- Can be converted into a pendant light using the optional suspension set
- The spots can be rotated 360° and pivoted 120°
- The entire light can be rotated through 360°

**Product details**

220-240V ~50/60Hz | 700mA  
Total wattage: 31W  
Material: aluminium/polycarbonate (PC)  
Dimmable: C

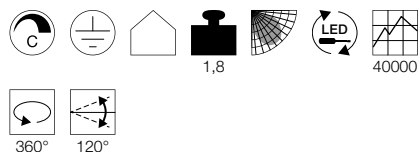

**Dimensional drawing**

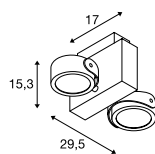

**Accessory recommendation**

- Suspension kit 1.5m  
Item No. 1001435
- Suspension kit 1.5m  
Item No. 1001436

Variant	Item No.
1900lm   3000K   CRI>80   24°	
■ black	<b>1001431</b>
1900lm   3000K   CRI>80   24°	
▨ white/black	<b>1001432</b>
1900lm   3000K   CRI>80   60°	
■ black	<b>1001423</b>
1900lm   3000K   CRI>80   60°	
▨ white/black	<b>1001424</b>

**TEC KALU**  
CL, quad, PHASE



- Can be converted into a pendant light using the optional suspension set
- The spots can be rotated 360° and pivoted 120°
- The entire light can be rotated through 360°

**Product details**

220-240V ~50/60Hz | 700mA  
Total wattage: 60W  
Material: aluminium/polycarbonate (PC)  
Dimmable: C

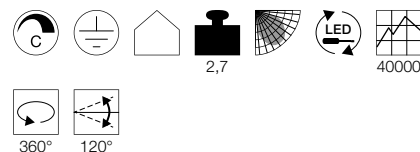

**Dimensional drawing**

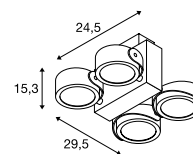

**Accessory recommendation**

- Suspension kit 1.5m  
Item No. 1001435
- Suspension kit 1.5m  
Item No. 1001436

Variant	Item No.
3800lm   3000K   CRI>80   24°	
■ black	<b>1001433</b>
3800lm   3000K   CRI>80   24°	
▨ white/black	<b>1001434</b>
3800lm   3000K   CRI>80   60°	
■ black	<b>1001425</b>
3800lm   3000K   CRI>80   60°	
▨ white/black	<b>1001426</b>



1001424 + 1001436 317

1002010 319



1002013 319



**TRILEDO**  
CL, single, round, QPAR51



**TRILEDO**  
CL, single, square, QPAR51



**TRILEDO**  
CL, double, square, QPAR51



**Product details**

220-240V ~50/60Hz  
Material: aluminium



**Dimensional drawing**

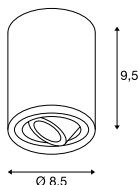

**Product details**

220-240V ~50/60Hz  
Material: aluminium



**Dimensional drawing**

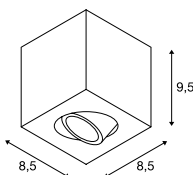

**Product details**

220-240V ~50/60Hz  
Material: aluminium



**Dimensional drawing**

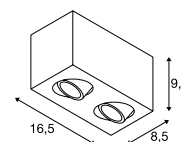

**Recommended lamp**

LED GU10 5.5W 36°  
2700K 400lm  
6kWh/1000h  
**Item No. 1001030**



LED GU10 6W 36°  
2700K 460lm  
6kWh/1000h  
**Item No. 1005076**



**Lamp details**

max. 10W LED GU10 51mm  
Diameter: 5 cm max. L: 5.5 cm max.

Variant	Item No.
GU10   QPAR51	
■ black	<b>1002010</b>
GU10   QPAR51	
□ white	<b>1002011</b>
GU10   QPAR51	
■ brushed aluminium	<b>1002012</b>

**Recommended lamp**

LED GU10 6W 36°  
3000K 460lm  
6kWh/1000h  
**Item No. 1005080**



LED GU10 4W 36°  
3000K 300lm  
4kWh/1000h  
**Item No. 1004973**



**Lamp details**

max. 10W LED GU10 51mm  
Diameter: 5 cm max. L: 5.5 cm max.

Variant	Item No.
GU10   QPAR51	
■ black	<b>1002013</b>
GU10   QPAR51	
□ white	<b>1002015</b>
GU10   QPAR51	
■ brushed aluminium	<b>1002004</b>

**Recommended lamp**

LED 6W 36°  
2700K 460lm  
6kWh/1000h  
**Item No. 1005075**



LED GU10 4W 36°  
2700K 300lm  
4kWh/1000h  
**Item No. 1004972**



**Lamp details**

2x max. 10W LED GU10 51mm  
Diameter: 5 cm max. L: 5.5 cm max.

Variant	Item No.
GU10   QPAR51	
■ black	<b>1002005</b>
GU10   QPAR51	
□ white	<b>1002006</b>

113931 321



1002008 321





TRILEDO  
CL, single, round



Product details

100-240V ~50/60Hz | 350mA  
Total wattage: 8.1W  
Material: aluminium

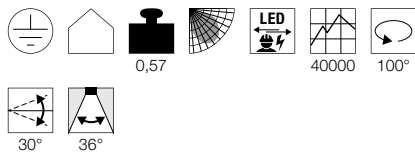

Dimensional drawing

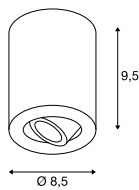

TRILEDO  
CL, single, square



Product details

100-240V ~50/60Hz | 350mA  
Total wattage: 8.1W  
Material: aluminium

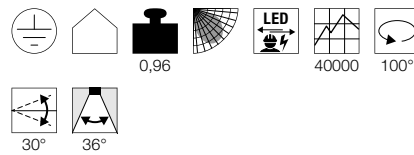

Dimensional drawing

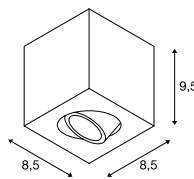

TRILEDO  
CL, double, square



Product details

220-240V ~50/60Hz | 350mA  
Total wattage: 14W  
Material: aluminium

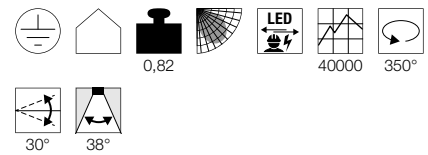

Dimensional drawing

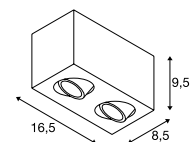

Variant	Item No.
670lm   3000K   CRI>80	
□ white	113931
670lm   3000K   CRI>80	
■ matt black	113930

Variant	Item No.
670lm   3000K   CRI>80	
□ white	113941
670lm   3000K   CRI>80	
■ matt black	113940

Variant	Item No.
1100lm   3000K   CRI>80	
□ white	1002008
1100lm   3000K   CRI>80	
■ black	1002003

PLASTRA  
CL, QPAR51SOCKET  
INSIDE

148004 272



- Can be individually designed with colours, stickers & more

## Product details

220-240V ~50/60Hz  
Material: gypsum/steel



1

## Dimensional drawing

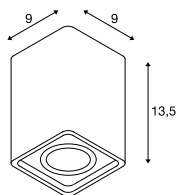

## Recommended lamp

LED GU10 6W 36°  
3000K 460lm  
6kWh/1000h  
Item No. 1005079



LED GU10 4W 36°  
3000K 300lm  
4kWh/1000h  
Item No. 1004973



## Lamp details

max. 35W QPAR51

Variant	Item No.
GU10   QPAR51	
□ matt white	148004



117101 274



**KARDAMOD**  
CL, square, single, QPAR111

SOCKET  
INSIDE



**KARDAMOD**  
CL, square, double, QPAR111

SOCKET  
INSIDE



**Product details**

230V -50Hz  
Material: steel



1,58

**Product details**

230V -50Hz  
Material: steel



2,88

**Dimensional drawing**

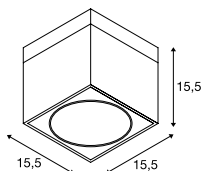

**Dimensional drawing**

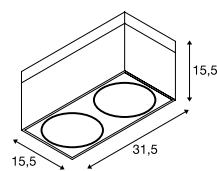

**Recommended lamp**

LED GU10 13W 55°  
2700K 840lm  
13kWh/1000h  
Item No. 1003094



LED GU10 6,5W 38°  
2700K 390lm  
7kWh/1000h  
Item No. 551882



**Recommended lamp**

LED GU10 13W 30°  
4000K 1100lm  
13kWh/1000h  
Item No. 1003087



LED GU10 13W 55°  
4000K 950lm  
13kWh/1000h  
Item No. 1003095



**Lamp details**

max. 75W QPAR111

**Lamp details**

2x max. 75W QPAR111

Variant	Item No.
GU10   QPAR111	
■ black	117100
GU10   QPAR111	
□ white	117101

Variant	Item No.
GU10   QPAR111	
■ black	117110
GU10   QPAR111	
□ white	117111



117110 274

**KARDAMOD**  
CL, round, single, QPAR111

SOCKET  
INSIDE



**Product details**

230V -50Hz  
Material: steel



1,5

**Dimensional drawing**

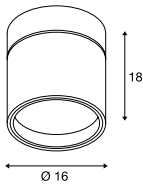

**Recommended lamp**

LED GU10 9W 25°  
2700-6500K 765lm  
9kWh/1000h  
Item No. 1001920



LED GU10 9W 40°  
2700-6500K 765lm  
9kWh/1000h  
Item No. 1001921



**Lamp details**

max. 75W QPAR111

Variant	Item No.
GU10   QPAR111	
■ black	117160
GU10   QPAR111	
□ white	117161

**KARDAMOD**  
CL, round, double, QPAR111

SOCKET  
INSIDE



**Product details**

230V -50Hz  
Material: steel



2,6

**Dimensional drawing**

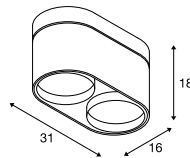

**Recommended lamp**

LED GU10 13W 30°  
4000K 1100lm  
13kWh/1000h  
Item No. 1003087



LED GU10 13W 140°  
4000K 1000lm  
13kWh/1000h  
Item No. 1003088



**Lamp details**

2x max. 75W QPAR111

Variant	Item No.
GU10   QPAR111	
■ black	117180
GU10   QPAR111	
□ white	117181

117181 276



114181 277



SUPROS 78  
CL, PHASE



Product details

220-240V ~50/60Hz | 250mA  
Total wattage: 12W  
Material: aluminium  
Dimmable: C, L

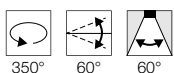
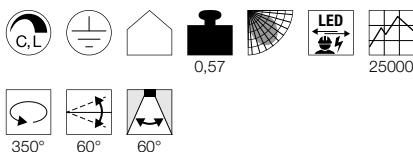

Dimensional drawing

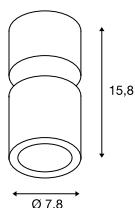

Accessory recommendation

Lens 20°  
Item No. 116302  
Lens 40°  
Item No. 116304

Variant	Item No.
700lm   3000K   CRI>80   60° ■ black	116330
700lm   3000K   CRI>80   60° □ white	116331

SUPROS  
CL, Move



Product details

220-240V ~50/60Hz | 750mA  
Total wattage: 31W  
Material: aluminium

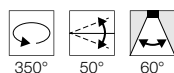

Dimensional drawing

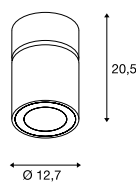

Accessory recommendation

Reflector 20°  
Item No. 114102  
Reflector 40°  
Item No. 114104

Variant	Item No.
2600lm   3000K   CRI>90 ■ black	1003289
2600lm   3000K   CRI>90 □ white	1003290
2700lm   4000K   CRI>90 ■ black	1003287
2700lm   4000K   CRI>90 □ white	1003288

SUPROS  
CL, Move



Product details

220-240V ~50/60Hz | 950mA  
Total wattage: 36W  
Material: aluminium

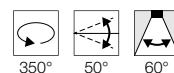

Dimensional drawing

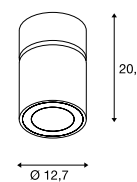

Accessory recommendation

Reflector 20°  
Item No. 114102  
Reflector 40°  
Item No. 114104

Variant	Item No.
3380lm   3000K   CRI>90 ■ black	1003283
3380lm   3000K   CRI>90 □ white	1003284
3520lm   4000K   CRI>90 ■ black	1003285
3520lm   4000K   CRI>90 □ white	1003286

# FOR THAT RADIANT LOOK.

## COMBINATION OF WALL AND CEILING LIGHTS.

---

Whereas ceiling lights call the tune with regard to general lighting, wall luminaires create individual impressions. A combination of the two is therefore ideal for an integrated light solution – providing many varying options; there are no limits to your creativity.



1005085 362





240000    372



WALL AND CEILING LIGHTS

 330	 330	<b>NEW</b>  331	 332	 333	 334	 334	 335
 336	 337	 337	 338	 339	 339	 341	 341
 341	 343	 343	 343	 345	 345	 345	 345
 347	 347	 347	 347	 349	 349	 349	 349
 350	 350	 350	 350	 352	 352	 352	 353
 356	 356	 356	 357	 357	 357	 358	 358
 358	 359	 359	 360	 360	 361	<b>FOLLOWER</b>  362	<b>FOLLOWER</b>  362
<b>FOLLOWER</b>  363	<b>FOLLOWER</b>  363	 365	 365	 366	 366	 366	 367
 367	 367	 369	 369	 370	 370	 371	 372
 373	 375						

**i** Other luminaires and variants can be found online at [www.slv.com](http://www.slv.com)  
You can find manufacturer's details for our recommended lamps in the chapter 'Lightbulbs', from page 844

SPOT 79  
CW, QPAR51

SOCKET  
INSIDE



INDA  
CW, QPAR51

SOCKET  
INSIDE



Product details

230V -50Hz  
Material: aluminium



0,25 350° 180°

Product details

230V -50Hz  
Material: aluminium



0,3 350° 180°

Dimensional drawing

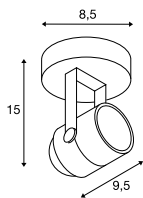

Dimensional drawing

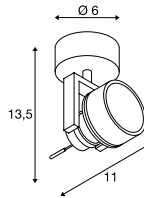

Recommended lamp

LED GU10 5.5W 38°  
2700K 400lm  
6kWh/1000h  
Item No. 1001030



LED GU10 4W 36°  
2700K 300lm  
4kWh/1000h  
Item No. 1004972



Recommended lamp

LED GU10 6W 36°  
3000K 460lm  
6kWh/1000h  
Item No. 1005078



LED GU10 6W 36°  
4000K 460lm  
6kWh/1000h  
Item No. 1005083



Lamp details

max. 50W QPAR51  
Diameter: 5cm max. L: 5.7cm max.

Lamp details

max. 50W QPAR51  
Diameter: 5cm max. L: 5.7cm max.

Variant	Item No.
GU10   QPAR51	
■ black	132020
GU10   QPAR51	
□ white	132021
GU10   QPAR51	
■ grey	132024

Variant	Item No.
GU10   QPAR51	
■ black	147550
GU10   QPAR51	
□ white	147551
GU10   QPAR51	
■ aluminium	147559

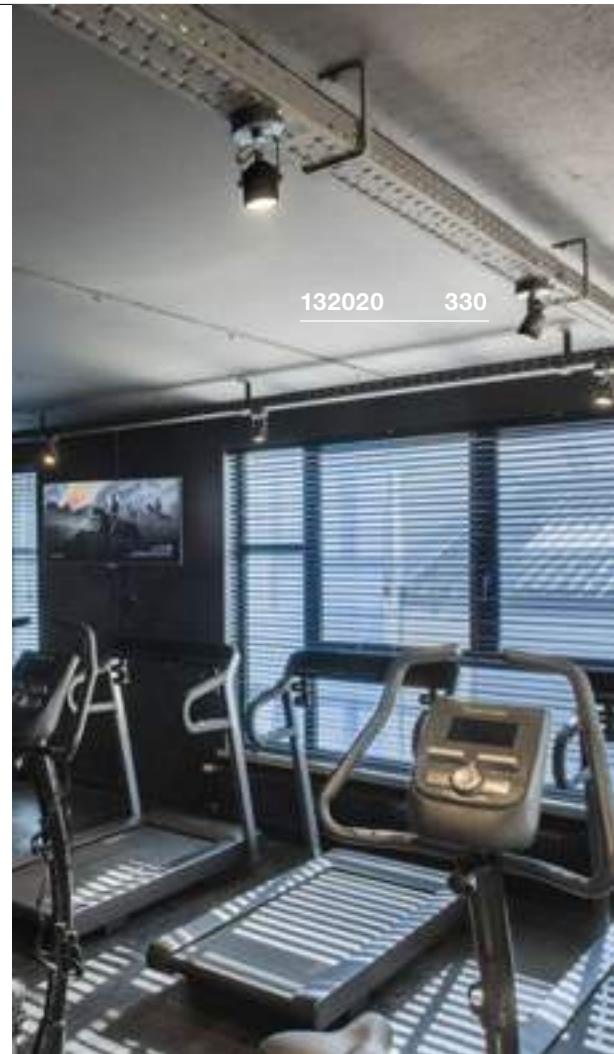



1004665 331

OCULUS  
CW, PHASE



Product details

220-240V ~50/60Hz | 250mA  
 Total wattage: 10.5W  
 Material: aluminium/glass  
 Dimmable: C

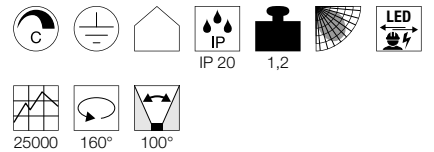

Dimensional drawing

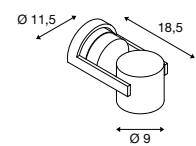

Variant	Item No.
36-780lm   2000-3000K   CRI>90	
■ matt black	1004664
36-780lm   2000-3000K   CRI>90	
□ matt white	1004665

## ALTRA DICE

CW, double, QPAR51



SOCKET  
INSIDE



1002215 332



- Light completely pivotable

### Product details

220-240V ~50/60Hz  
Material: aluminium/steel



### Dimensional drawing

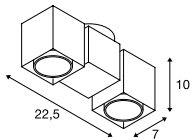

### Recommended lamp

LED 6W 36°  
2700K 460lm  
6kWh/1000h  
Item No. 1005075



LED GU10 4W 36°  
2700K 300lm  
4kWh/1000h  
Item No. 1004972



### Lamp details

2x max. 50W QPAR51

Variant	Item No.
GU10   QPAR51	
□ white	151531
GU10   QPAR51	
■ grey/black	151534
GU10   QPAR51	
■ black	1002215





1002585 333



1002584 333

FITU  
CW, E27
**SOCKET**  
**INSIDE**



#### Product details

220-240V ~50/60Hz  
 Material: aluminium/steel

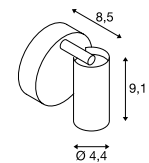

0,31 330° 120°

#### Dimensional drawing



#### Recommended lamp

LED E27 7W 280°  
 2700K 790lm  
 7kWh/1000h  
**Item No. 1002124**



LED E27 10,5W 360°  
 2700K 1000lm  
 10,5kWh/1000h  
**Item No. 1003093**



#### Lamp details

max. 60W

Variant	Item No.
E27	
□ white	1002584
E27	
■ black	1002585

KARPO 30  
CW, single



KARPO 30  
CW, single, PHASE

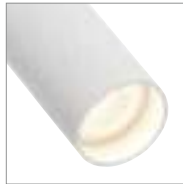

- Premium LED with CRI>90

- Premium LED with CRI>90
- Dimmable

Product details

100-240V ~50/60Hz | 500mA  
Total wattage: 9.5W  
Material: aluminium/steel

Product details

220-240V ~50/60Hz | 500mA  
Total wattage: 9W  
Material: aluminium/steel  
Dimmable: C

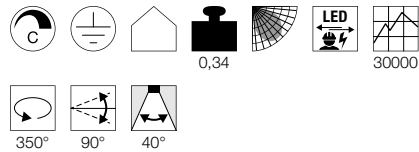

Dimensional drawing

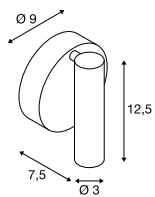

Dimensional drawing

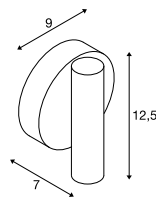

152331 334



Variant	Item No.
480lm   3000K   CRI>90	
■ black	152330
530lm   3000K   CRI>90	
□ white	152331

Variant	Item No.
580lm   3000K   CRI>90	
■ black	1001495
600lm   3000K   CRI>90	
□ white	1001496



1000247 335

TOTHEE  
CW, PHASE



LED  
INSIDE



**Product details**

220-240V ~50/60Hz | 350mA  
 Total wattage: 17W  
 Material: aluminium  
 Dimmable: C, L

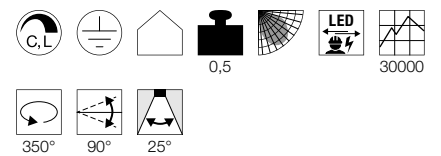

**Dimensional drawing**

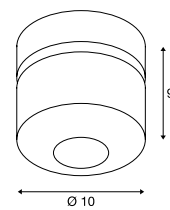

Variant	Item No.
1250lm   3000K   CRI>80	
■ black	1000426
1250lm   3000K   CRI>80	
■ white/black	1000427

**BILAS**  
CW, single, PHASE



156420 336



- High-voltage LED

**Product details**

230V ~50/60Hz  
Total wattage: 16W  
Material: aluminium/glass  
Dimmable: C, L

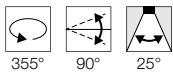

**Dimensional drawing**

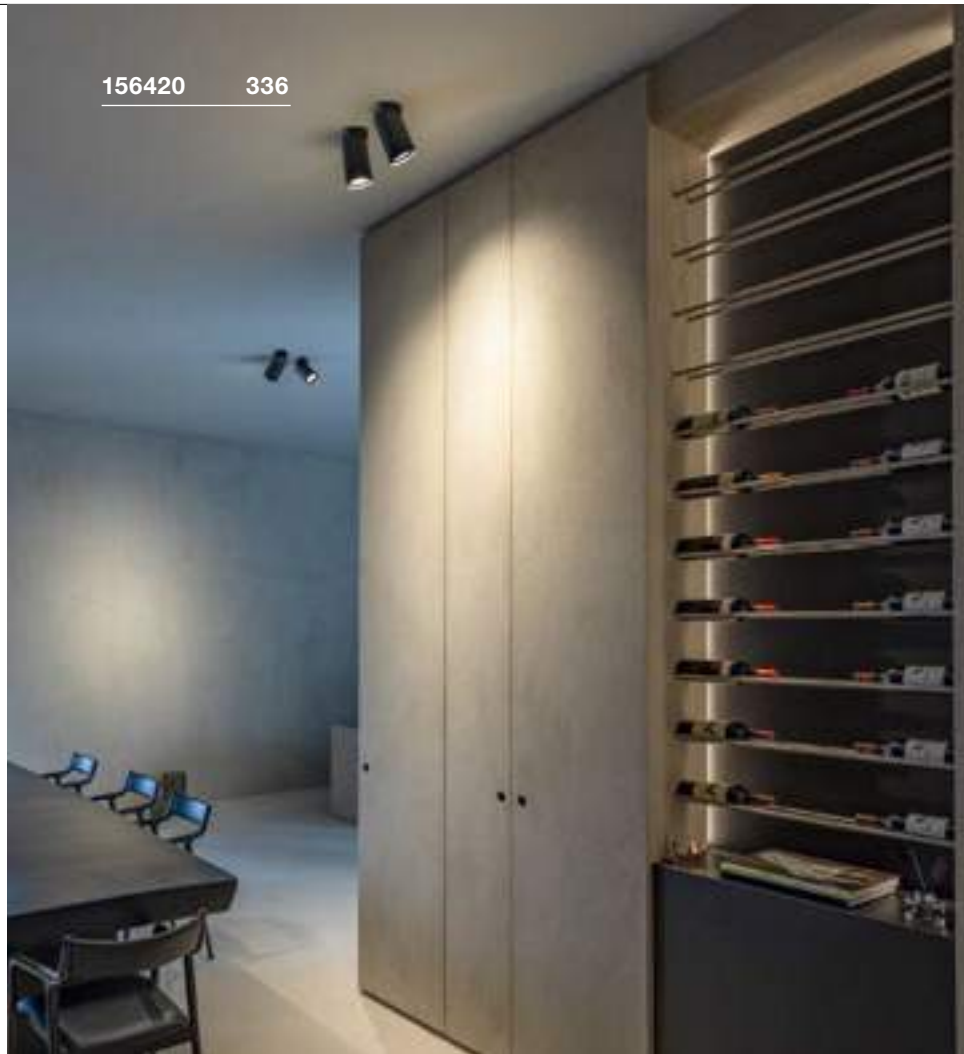
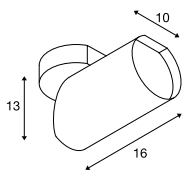

156420 336

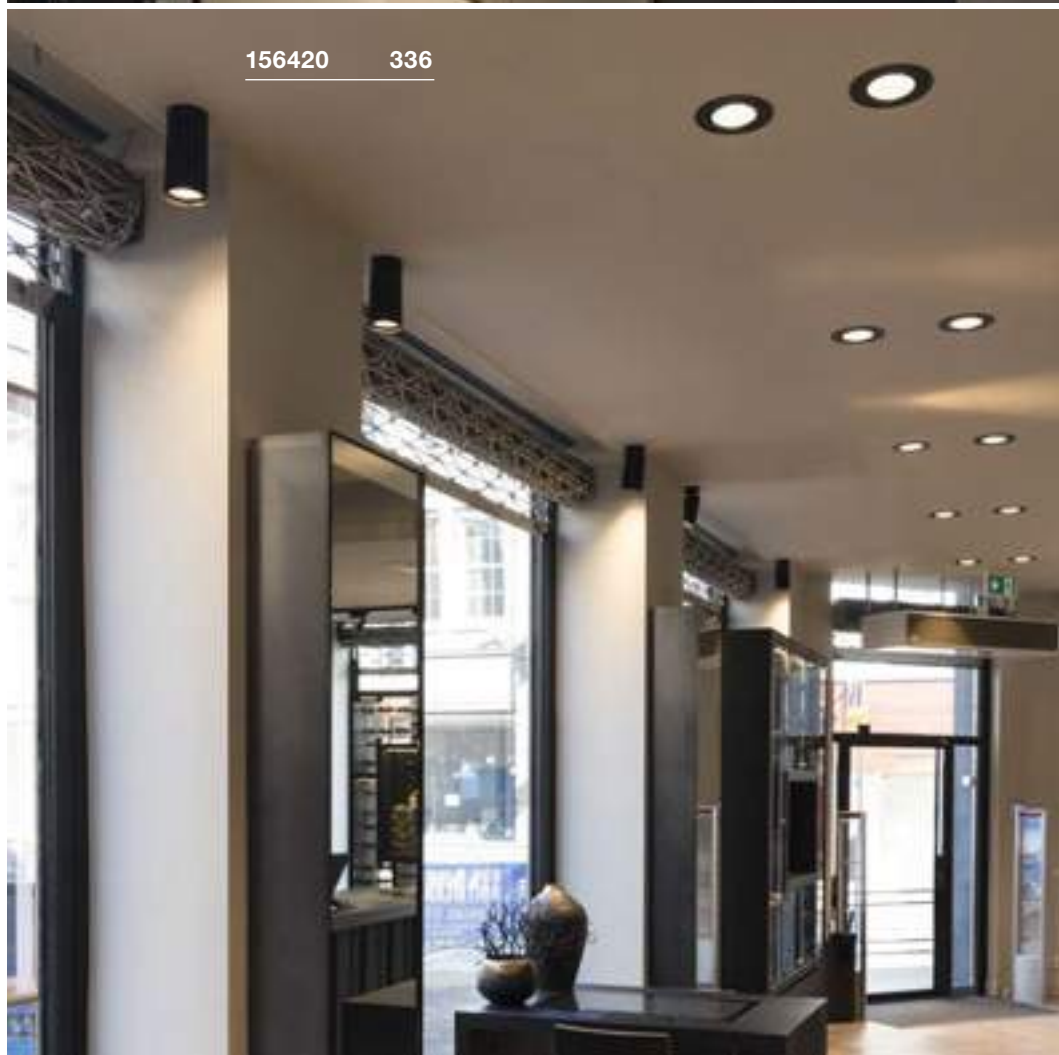

Variant	Item No.
1000lm   2700K   CRI>80	
■ matt black	156420
1000lm   2700K   CRI>80	
□ matt white	156421





148004 322 152010 337

**ENOLA B**  
CW, single, QPAR51



SOCKET  
INSIDE



**Product details**

220-240V ~50/60Hz  
Material: aluminium/steel



0,39 350° 100°

**Dimensional drawing**

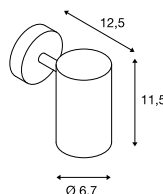

**Tip**

Decorative ring in light colour included.  
Optional black decorative ring available as an accessory.

**Accessory recommendation**

Decorative ring  
Item No. 151840



**Recommended lamp**

LED GU10 6W 36°  
4000K 460lm  
6kWh/1000h  
Item No. 1005081



LED GU10 4W 36°  
3000K 300lm  
4kWh/1000h  
Item No. 1004973



**Lamp details**

max. 50W QPAR51  
L: 6.7 cm max.

Variant	Item No.
GU10   QPAR51	
■ black	152010
□ white	152011
■ gold	152013

**ENOLA B**  
CW, double, QPAR51



SOCKET  
INSIDE



**Product details**

220-240V ~50/60Hz  
Material: aluminium/steel

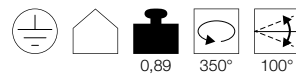

0,89 350° 100°

**Dimensional drawing**

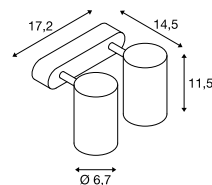

**Tip**

Decorative ring in light colour included.  
Optional black decorative ring available as an accessory.

**Accessory recommendation**

Decorative ring  
Item No. 151840



**Recommended lamp**

LED GU10 6W 36°  
2700K 460lm  
6kWh/1000h  
Item No. 1005077



LED GU10 4W 36°  
4000K 300lm  
4kWh/1000h  
Item No. 1004974



**Lamp details**

2x max. 50W QPAR51  
L: 6.7 cm max.

Variant	Item No.
GU10   QPAR51	
■ black	152020
□ white	152021
■ gold	152023



152023 337

**ENOLA B**  
CW, double, QPAR51



SOCKET  
INSIDE



156510 339



**Product details**

220-240V ~50/60Hz  
Material: aluminium/steel



0,83 350° 180°

**Dimensional drawing**

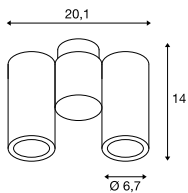

**Tip**

Decorative ring in light colour included.  
Optional black decorative ring available  
as an accessory.

**Accessory recommendation**

■ Decorative ring  
Item No. 151840



**Recommended lamp**

LED GU10 5.5W 38°  
2700K 400lm  
6kWh/1000h  
Item No. 1001030



LED GU10 6W 36°  
3000K 460lm  
6kWh/1000h  
Item No. 1005079



**Lamp details**

2x max. 50W QPAR51  
L: 8 cm max.

Variant	Item No.
GU10   QPAR51	
■ black	151830
GU10   QPAR51	
□ white	151831





156501 339



156500 339

HELIA  
CW, single, PHASE



- Premium LED with CRI>90

Product details

220-240V ~50/60Hz | 500mA  
Total wattage: 11W  
Material: aluminium  
Dimmable: C

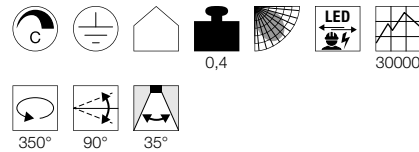

Dimensional drawing

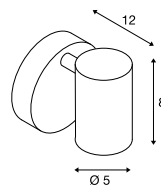

HELIA  
CW, double, PHASE



- Premium LED with CRI>90

Product details

220-240V ~50/60Hz | 500mA  
Total wattage: 18W  
Material: aluminium  
Dimmable: C, L

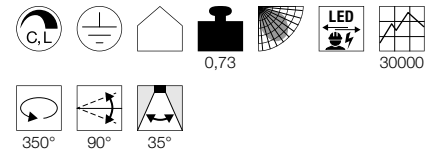

Dimensional drawing

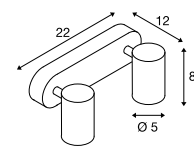

Variant	Item No.
620lm   3000K   CRI>90	
■ black	156500
620lm   3000K   CRI>90	
□ white	156501

Variant	Item No.
1200lm   3000K   CRI>90	
■ black	156510
1200lm   3000K   CRI>90	
□ white	156511

147414 341



**ASTO TUBE**  
CW, QPAR51

**Product details**

230V -50Hz  
Total wattage: 50W  
Material: aluminium



**Recommended lamp**

LED GU10 6W 36°  
3000K 460lm  
6kWh/1000h  
**Item No. 1005079**

LED GU10 4W 36°  
3000K 300lm  
4kWh/1000h  
**Item No. 1004973**



**ASTO TUBE**  
CW, single, QPAR51

**SOCKET**  
**INSIDE**



**Dimensional drawing**

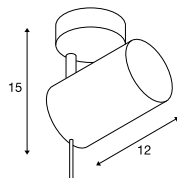

**Lamp details**

max. 50W QPAR51  
Diameter: 6.4cm max. L. 8.1cm max.

Variant	Item No.
GU10   QPAR51   0.34 kg □ white	<b>147411</b>

**ASTO TUBE**  
CW, double, QPAR51

**SOCKET**  
**INSIDE**

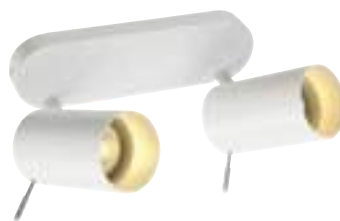

**Dimensional drawing**

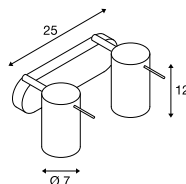

**Lamp details**

2x max. 50W QPAR51  
Diameter: 6.4cm max. L. 8.1cm max.

Variant	Item No.
GU10   QPAR51   0.7 kg □ white	<b>147412</b>

**ASTO TUBE**  
CW, triple, QPAR51

**SOCKET**  
**INSIDE**



**Dimensional drawing**

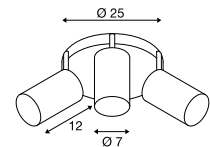

**Lamp details**

3x max. 50W QPAR51  
Diameter: 6.4cm max. L. 8.1cm max.

Variant	Item No.
GU10   QPAR51   1.15 kg □ white	<b>147414</b>

1002974 343



**NOBLO**  
CW, PHASE



- Rotating and pivoting light head

**Product details**

220-240V ~50/60Hz | 350mA

Material: aluminium

Dimmable: C, L

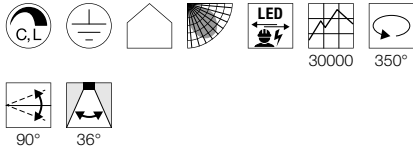

**NOBLO**  
CW, single, PHASE



**Dimensional drawing**

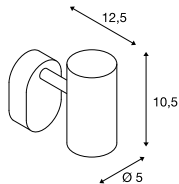

Variant	Item No.
600lm   2700K   CRI>80   8W   0.31 kg	
■ black	<b>1002969</b>
600lm   2700K   CRI>80   8W   0.31 kg	
□ white	<b>1002970</b>
600lm   2700K   CRI>80   8W   0.31 kg	
■ silver grey	<b>1002971</b>

**NOBLO**  
CW, double, PHASE



**Dimensional drawing**

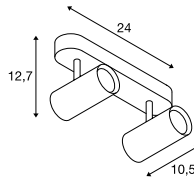

Variant	Item No.
1200lm   2700K   CRI>80   16W   0.67 kg	
■ black	<b>1002973</b>
1200lm   2700K   CRI>80   16W   0.67 kg	
□ white	<b>1002974</b>
1200lm   2700K   CRI>80   16W   0.67 kg	
■ silver grey	<b>1002975</b>

**NOBLO**  
CW, triple, PHASE



**Dimensional drawing**

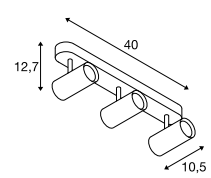

Variant	Item No.
1800lm   2700K   CRI>80   24W   1 kg	
■ black	<b>1002976</b>
1800lm   2700K   CRI>80   24W   1 kg	
□ white	<b>1002977</b>
1800lm   2700K   CRI>80   24W   1 kg	
■ silver grey	<b>1002978</b>



1000892 345



1000887 345



AVO  
CW, QPAR51



Product details

230V -50Hz  
Material: steel

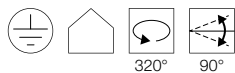

Recommended lamp

LED GU10 6W 36°  
3000K 460lm  
6kWh/1000h  
Item No. 1005078



LED GU10 4W 36°  
2700K 300lm  
4kWh/1000h  
Item No. 1004972



AVO  
CW, single, QPAR51

SOCKET  
INSIDE



Dimensional drawing

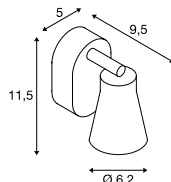

Lamp details

max. 50W QPAR51

Variant	Item No.
GU10   QPAR51   0.22 kg	
■ black	1000886
GU10   QPAR51   0.22 kg	
□ white	1000887
GU10   QPAR51   0.22 kg	
■ silver grey	1000888

AVO  
CW, double, QPAR51

SOCKET  
INSIDE



Dimensional drawing

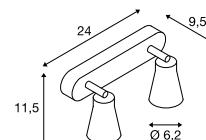

Lamp details

2x max. 50W QPAR51

Variant	Item No.
GU10   QPAR51   0.47 kg	
■ black	1000889
GU10   QPAR51   0.47 kg	
□ white	1000890
GU10   QPAR51   0.47 kg	
■ silver grey	1000891

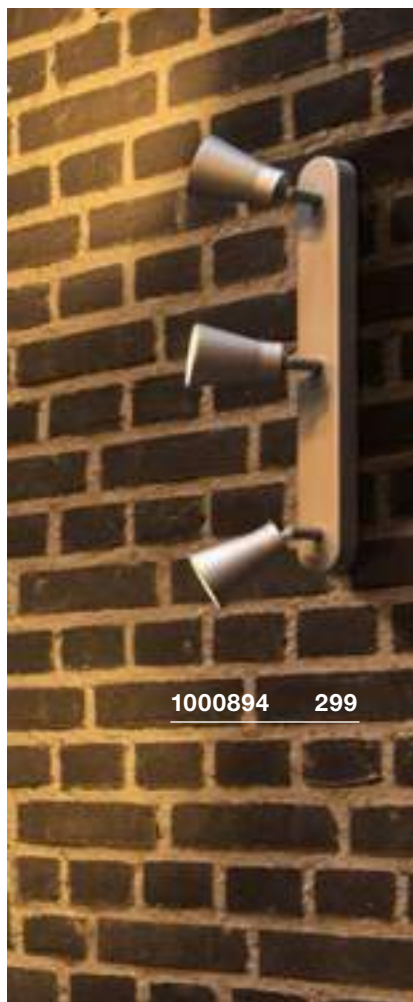

AVO  
CW, triple, QPAR51

SOCKET  
INSIDE



Dimensional drawing

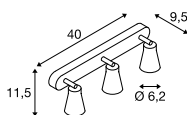

Lamp details

3x max. 50W QPAR51

Variant	Item No.
GU10   QPAR51   0.71 kg	
■ black	1000892
GU10   QPAR51   0.71 kg	
□ white	1000893
GU10   QPAR51   0.71 kg	
■ silver grey	1000894

AVO  
CW, quad, QPAR51

SOCKET  
INSIDE



Dimensional drawing

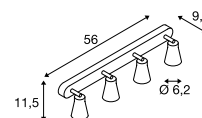

Lamp details

4x max. 50W QPAR51

Variant	Item No.
GU10   QPAR51   1 kg	
■ black	1000895
GU10   QPAR51   1 kg	
□ white	1000896
GU10   QPAR51   1 kg	
■ silver grey	1000897

147443    347



147316    304

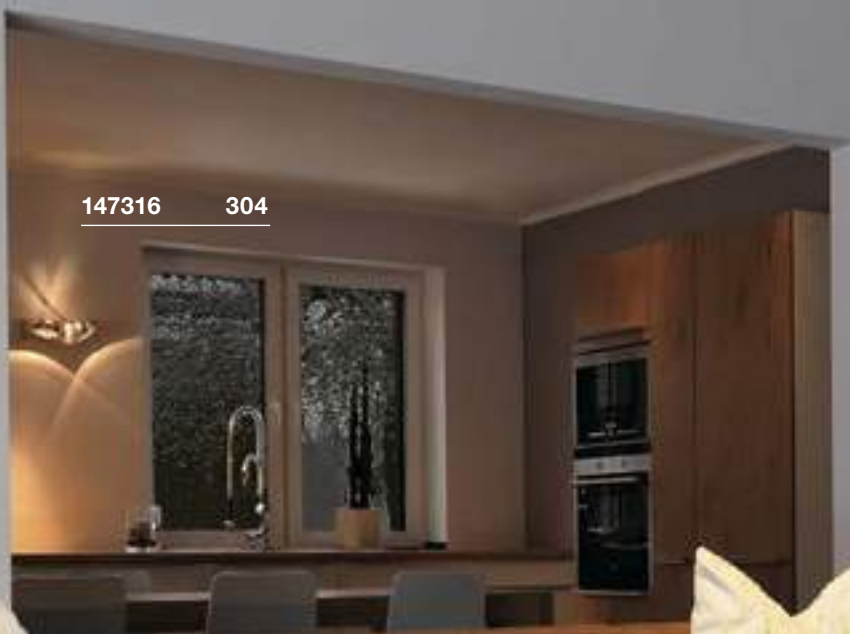

ASTO  
QPAR51



Product details

230V -50Hz  
Material: aluminium



Recommended lamp

LED 6W 36°  
2700K 460lm  
6kWh/1000h  
Item No. 1005075



LED GU10 4W 36°  
3000K 300lm  
4kWh/1000h  
Item No. 1004973



ASTO  
CW, single, QPAR51

SOCKET  
INSIDE



Dimensional drawing

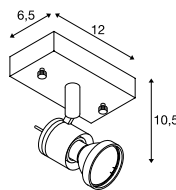

Lamp details

max. 50W QPAR51

Variant	Item No.
GU10   QPAR51   0.25 kg aluminium	147441

ASTO  
CW, double, QPAR51

SOCKET  
INSIDE



Dimensional drawing

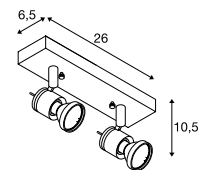

Lamp details

max. 75W QPAR51

Variant	Item No.
GU10   QPAR51   0.35 kg aluminium	147442



ASTO  
CW, triple, QPAR51

SOCKET  
INSIDE



Dimensional drawing

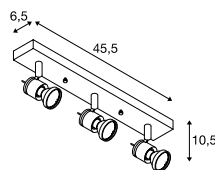

Lamp details

max. 75W QPAR51

Variant	Item No.
GU10   QPAR51   0.55 kg aluminium	147443

ASTO  
CW, quad, QPAR51

SOCKET  
INSIDE



Dimensional drawing

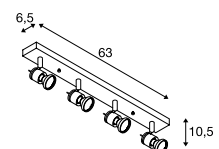

Lamp details

max. 75W QPAR51

Variant	Item No.
GU10   QPAR51   0.8 kg aluminium	147444

1002030 349



PURI  
CW, QPAR51



Product details

230V -50Hz  
Material: aluminium/steel



Recommended lamp

LED GU10 4W 36°  
2700K 300lm  
4kWh/1000h  
Item No. 1004972

LED GU10 6W 36°  
3000K 460lm  
6kWh/1000h  
Item No. 1005080



PURI  
CW, single, QPAR51

SOCKET  
INSIDE



Dimensional drawing

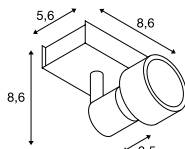

PURI  
CW, double, QPAR51

SOCKET  
INSIDE



Dimensional drawing

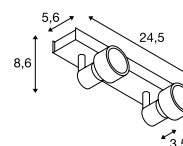

Lamp details

max. 50W QPAR51

Variant	Item No.
GU10   QPAR51   0.27 kg	
■ black	147360
GU10   QPAR51   0.27 kg	
□ white	147361

Lamp details

2x max. 50W QPAR51

Variant	Item No.
GU10   QPAR51   0.62 kg	
■ black	147370
GU10   QPAR51   0.62 kg	
□ white	147371



PURI  
CW, triple, QPAR51

SOCKET  
INSIDE



Dimensional drawing

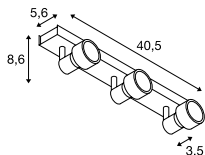

Lamp details

3x max. 50W QPAR51

Variant	Item No.
GU10   QPAR51   0.98 kg	
■ black	147380
GU10   QPAR51 0.98 kg	
□ white	147381

PURI  
CW, quad, QPAR51

SOCKET  
INSIDE



Dimensional drawing

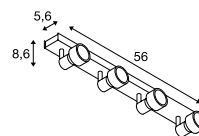

Lamp details

4x max. 50W QPAR51

Variant	Item No.
GU10   QPAR51   1.25 kg	
■ black	1002029
GU10   QPAR51   1.25 kg	
□ matt white	1002030

**KALU**  
CW, QPAR111



**KALU**  
CW, single, QPAR111

SOCKET  
INSIDE



Dimensional drawing

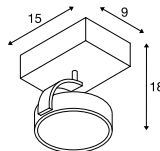

Lamp details

max. 75W QPAR111

Variant	Item No.
GU10   QPAR111   0.44 kg	
■ black	<b>1000702</b>
GU10   QPAR111   0.44 kg	
□ white	<b>147301</b>
GU10   QPAR111   0.44 kg	
■ aluminium	<b>147306</b>

**KALU**  
CW, double, QPAR111

SOCKET  
INSIDE



Dimensional drawing

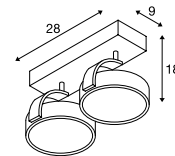

Lamp details

2x max. 75W QPAR111

Variant	Item No.
GU10   QPAR111   0.8 kg	
■ black	<b>1000703</b>
GU10   QPAR111   0.8 kg	
□ white	<b>147311</b>
GU10   QPAR111   0.8 kg	
■ aluminium	<b>147316</b>

Product details

220-240V ~50/60Hz

Material: aluminium

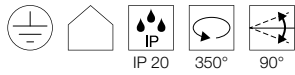

Recommended lamp

LED GU10 13W 55°  
2700K 840lm  
13kWh/1000h  
Item No. **1003094**



LED GU10 6.5W 38°  
2700K 390lm  
7kWh/1000h  
Item No. **551882**



**KALU**  
CW, triple, QPAR111

SOCKET  
INSIDE



Dimensional drawing

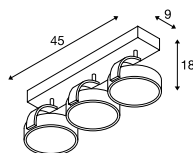

Lamp details

3x max. 75W QPAR111

Variant	Item No.
GU10   QPAR111   1.23 kg	
■ black	<b>1000704</b>
GU10   QPAR111   1.23 kg	
□ white	<b>147321</b>
GU10   QPAR111   1.23 kg	
■ aluminium	<b>147326</b>

**KALU**  
CW, quad, QPAR111

SOCKET  
INSIDE



Dimensional drawing

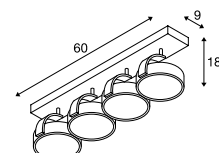

Lamp details

4x max. 75W QPAR111

Variant	Item No.
GU10   QPAR111   1.7 kg	
■ black	<b>1002023</b>
GU10   QPAR111   1.7 kg	
□ white	<b>1002024</b>
GU10   QPAR111   1.7 kg	
■ aluminium	<b>1002025</b>

1002024 350



1000702 350



KALU  
CW, PHASE



- Lighting unit can be rotated and swivelled through 340°

Product details

220-240V ~50/60Hz | 350mA  
Material: aluminium/polycarbonate (PC)  
Dimmable: C

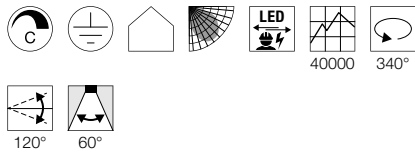

KALU  
CW, single, PHASE



Dimensional drawing

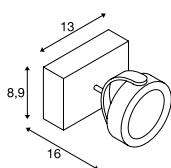

Variant	Item No.
1000lm   3000K   CRI>80   17W   0.77 kg ■ black	<b>1000127</b>
1000lm   3000K   CRI>80   17W   0.77 kg ■ white/black	<b>1000128</b>

KALU  
CW, double, PHASE



Dimensional drawing

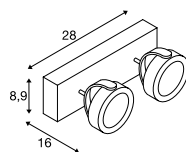

Variant	Item No.
2000lm   3000K   CRI>80   31W   1.6 kg ■ black	<b>1000129</b>
2000lm   3000K   CRI>80   31W   1.6 kg ■ white/black	<b>1000130</b>

KALU  
CW, triple, PHASE



Dimensional drawing

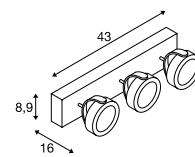

Variant	Item No.
3000lm   3000K   CRI>80   47W   2.2 kg ■ black	<b>1000131</b>
3000lm   3000K   CRI>80   47W   2.2 kg ■ white/black	<b>1000132</b>



1000136 353



## KALU CW, quad, PHASE



LED  
INSIDE



- Lighting unit can be rotated and swivelled through 340°
- Premium LED

### Product details

220-240V ~50/60Hz | 700mA

Total wattage: 60W

Material: aluminium/polycarbonate (PC)

Dimmable: C

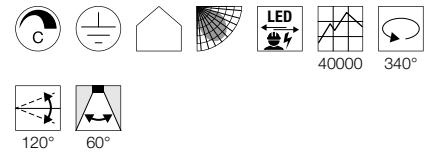



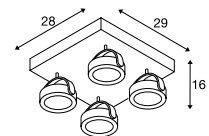





### Dimensional drawing



Variant	Item No.
4000lm   3000K   CRI>80   3.75 kg	
■ black	<b>1000135</b>
4000lm   3000K   CRI>80   3.75 kg	
■ white/black	<b>1000136</b>









# LIPSY® LIGHTING SERIES.

## THE COLOURS YOU WANT.

	LIPSY® 30 Connected	LIPSY® 40 Connected	LIPSY® 50 Connected
Example			
Lamp			
Sensor	-	-	-
Size	Diameter: 28 cm	Diameter: 39 cm	Diameter: 49.6 cm
Colour temperature	3000K	3000K	3000K
Light colour	1400lm	1700lm	2800lm
Control/dimmable	 Remote-controllable and dimmable with SLV VALETO® CCT/RGBW remote control [1002994] or Gateway [1002411]	 Remote-controllable and dimmable with SLV VALETO® CCT/RGBW remote control [1002994] or Gateway [1002411]	 Remote-controllable and dimmable with SLV VALETO® CCT/RGBW remote control [1002994] or Gateway [1002411]

	LIPSY® 30 Dome	LIPSY® 40 Dome	LIPSY® 50 Dome	
Example				
Lamp				
Sensor	-	-	-	
Size	Diameter: 30 cm	Diameter: 35 cm	Diameter: 40 cm	
Colour temperature	3000K   4000K	3000K   4000K	3000K   4000K	
Light colour	1400/1600lm	1800/2000lm	2200/2400lm	 <p><b>With this LIPSY® variant</b> you can select/change the colour temperature yourself!</p>
Control/dimmable	-	-	-	

	LIPSY® 30 Drum	LIPSY® 40 Drum	LIPSY® 50 Drum	
Example				    <b>With this LIPSY® variant</b> you can select/change the colour temperature yourself!
Lamp				
Sensor	-	-	-	
Size	Diameter: 30 cm	Diameter: 35 cm	Diameter: 40 cm	
Colour temperature	3000K   4000K	3000K   4000K	3000K   4000K	
Light colour	1400/1600lm	1800/2000lm	2200/2400lm	
Control/dimmable	-	-	-	

	LIPSY® 40 CW, Drum, DALI	LIPSY® 50 CW, Drum, DALI	
Example			    <b>With this LIPSY® variant</b> you can select the colour temperature yourself!
Lamp			
Sensor	-	-	
Size	Diameter: 35 cm	Diameter: 40 cm	
Colour temperature	3000K   4000K	3000K   4000K	
Light colour	1800/2000lm	2200/2400lm	
Control/dimmable			

LIPSY®  
CW, Connected

- Can be integrated with the Connected System

Product details

230V ~50/60Hz  
Total wattage: 14.5W/17W/31.5W  
Material: Polymethylacrylate (PMMA)/steel



Tip

Remote-controllable and dimmable with SLV VALETO® CCT/RGBW remote control [1002994] or Gateway [1002411]



LIPSY® 30  
CW, Connected



Dimensional drawing

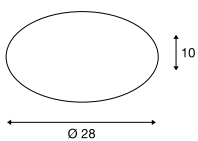

LIPSY® 40  
CW, Connected



Dimensional drawing

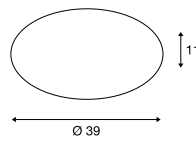

LIPSY® 50  
CW, Connected



Dimensional drawing

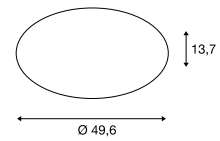

Variant	Item No.
1400lm   3000K   CRI>80   0.4 kg □ white	1002132

Variant	Item No.
1700lm   3000K   CRI>80   0.77 kg □ white	1002133

Variant	Item No.
2800lm   3000K   CRI>80   1.36 kg □ white	1002134

LIPSY®  
CW, Dome

- Colour temperature (3000K/4000K) can be adjusted using the switch

Product details

220-240V ~50/60Hz | 500mA  
Total wattage: 15W/18W/21W  
Material: aluminium/polycarbonate (PC)

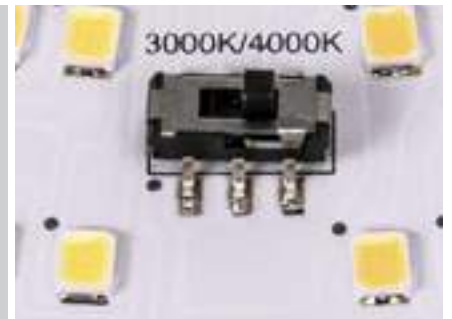
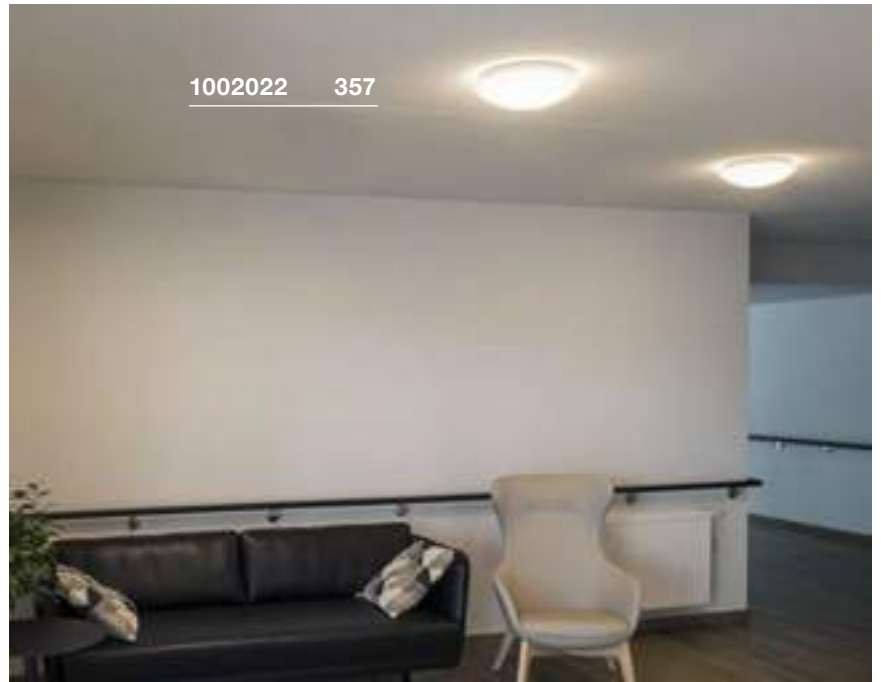
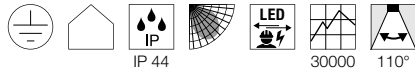

LIPSY® 30  
CW, Dome



Dimensional drawing

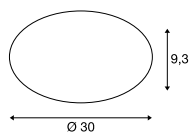

LIPSY® 40  
CW, Dome



Dimensional drawing

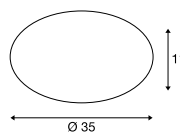

LIPSY® 50  
CW, Dome



Dimensional drawing

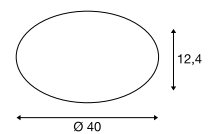

Variant	Item No.
1400/1600lm   3000/4000K   CRI>80   0.6 kg □ white	1002020

Variant	Item No.
1800/2000lm   3000/4000K   CRI>80   0.77 kg □ white	1002021

Variant	Item No.
2200/2400lm   3000/4000K   CRI>80   0.96 kg □ white	1002022

LIPSY®  
CW, Drum

- Colour temperature (3000K/4000K) can be adjusted using the switch

Product details

220-240V ~50/60Hz | 500mA  
Total wattage: 15W/18W/21W  
Material: aluminium/polycarbonate (PC)

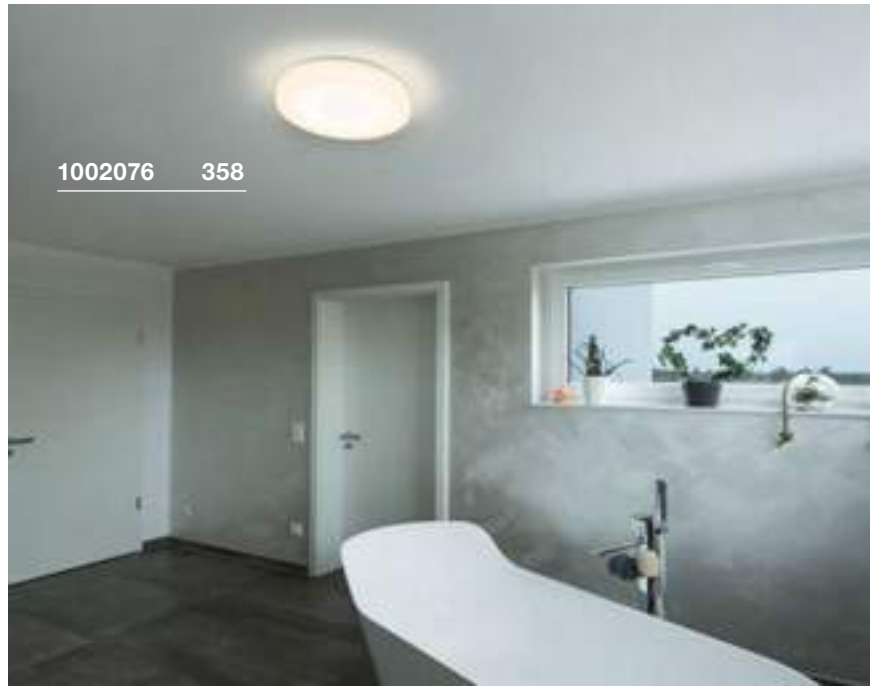
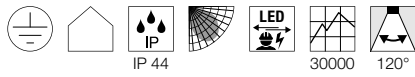

LIPSY® 30  
CW, Drum



Dimensional drawing

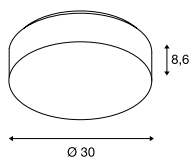

LIPSY® 40  
CW, Drum



Dimensional drawing

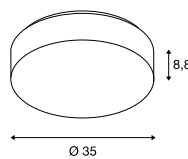

LIPSY® 50  
CW, Drum



Dimensional drawing

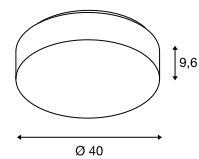

Variant	Item No.
1400/1600lm   3000/4000K   CRI>80   0.6 kg □ white	1002075

Variant	Item No.
1800/2000lm   3000/4000K   CRI>80   0.77 kg □ white	1002076

Variant	Item No.
2200/2400lm   3000/4000K   CRI>80   0.96 kg □ white	1002077

LIPSY®  
CW, Drum, DALI

- Colour temperature (3000K/4000K) can be adjusted using the switch

Product details

220-240V ~50/60Hz | 500mA  
Total wattage: 8W/21W  
Material: aluminium/polycarbonate (PC)  
Dimmable: Dali

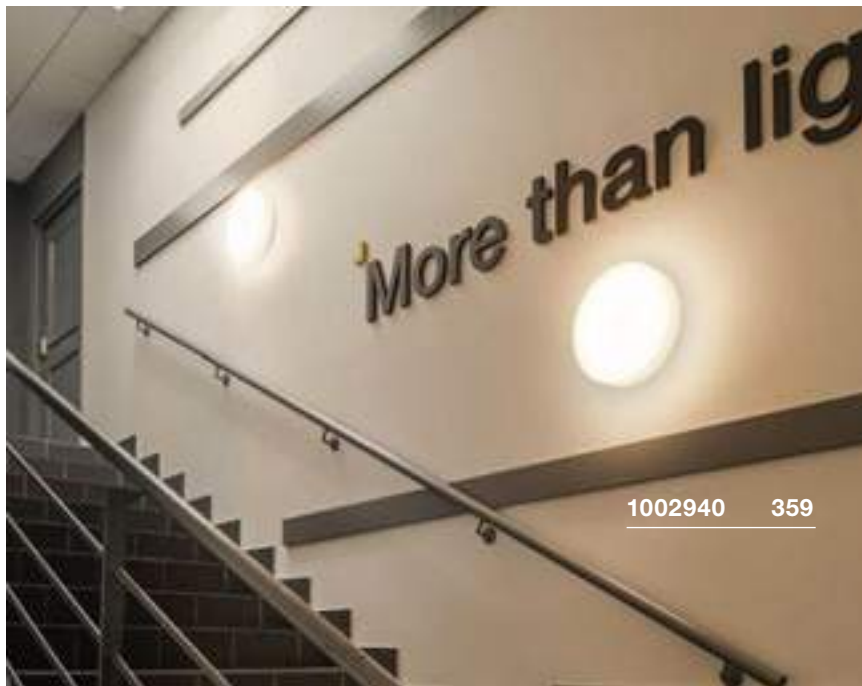
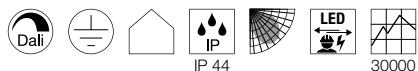

LIPSY® 40  
CW, Drum, DALI



Dimensional drawing

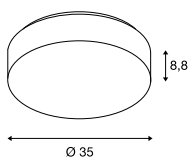

Variant	Item No.
1800/2000lm   3000/4000K   CRI>80   0.77 kg □ white	<b>1002940</b>

LIPSY® 50  
CW, Drum, DALI



Dimensional drawing

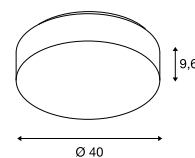

Variant	Item No.
2200/2400lm   3000/4000K   CRI>80   0.96 kg □ white	<b>1002941</b>

**MARONA**  
CW, PHASE



**MELAN**  
CW, E27



**Product details**

200-240V ~50/60Hz | 430mA  
Total wattage: 15W  
Material: Polymethylacrylate (PMMA)/steel  
Dimmable: C, L

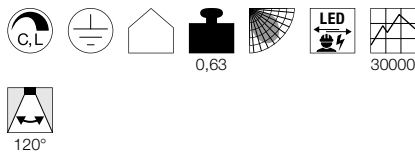

**Product details**

230V -50Hz  
Material: aluminium/glass



**Dimensional drawing**

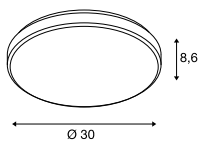

**Dimensional drawing**

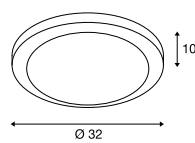

**Recommended lamp**

LED E27 9.1W 240°  
2700K 760lm  
10kWh/1000h  
**Item No. 560402**



LED E27 7W  
2700K 810lm  
7kWh/1000h  
**Item No. 1003090**



**Lamp details**

max. 60W  
Diameter: 7 cm max. L: 16 cm max.

Variant	Item No.
1200lm   3000K   CRI>80 chrome	155152
1200lm   3000K   CRI>80 grey	155156

Variant	Item No.
E27 aluminium	155236

155156 360







155236 360

## GLASSA

CW, square, E27

SOCKET  
INSIDE



### Product details

230V -50Hz  
Material: satin-finish glass/steel

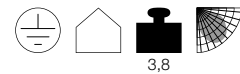

3,8

### Dimensional drawing

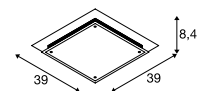

155180 361

### Recommended lamp

LED E27 9W 240°  
3000K 810lm  
10kWh/1000h  
Item No. 1001031

LED E27 9W 240°  
4000K 850lm  
9kWh/1000h  
Item No. 1002827



### Lamp details

2x max. 60W  
Diameter: 4.8 cm max. L: 1.48 cm max.

Variant	Item No.
E27	
chrome	155180

SIMA  
CW, round, PHASE



- Flat, robust construction
- With spacer for cable surface mounting
- Contains recycled material

Product details

220-240V ~50/60Hz | 350mA  
Total wattage: 24W  
Material: Polycarbonate (PC)  
Dimmable: C, L

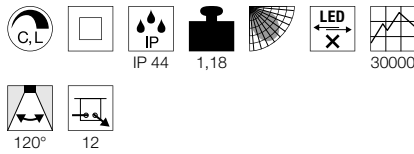

Dimensional drawing

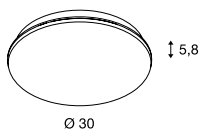

SIMA  
CW, round, Sensor

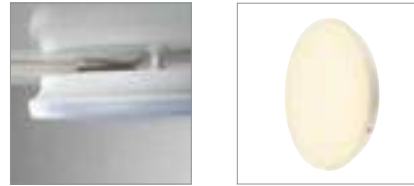

- Flat, robust construction
- With spacer for cable surface mounting
- Motion detector with MR (microwave) technology integrated in light housing
- Contains recycled material

Product details

220-240V ~50/60Hz | 350mA  
Total wattage: 24W  
Material: Polycarbonate (PC)

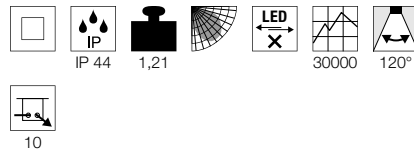

Dimensional drawing

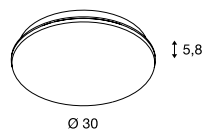

1005085 362



Variant	Item No.
2150lm   3000K   CRI>90 □ white	1005085

Variant	Item No.
2150lm   3000K   CRI>90 □ white	1005086

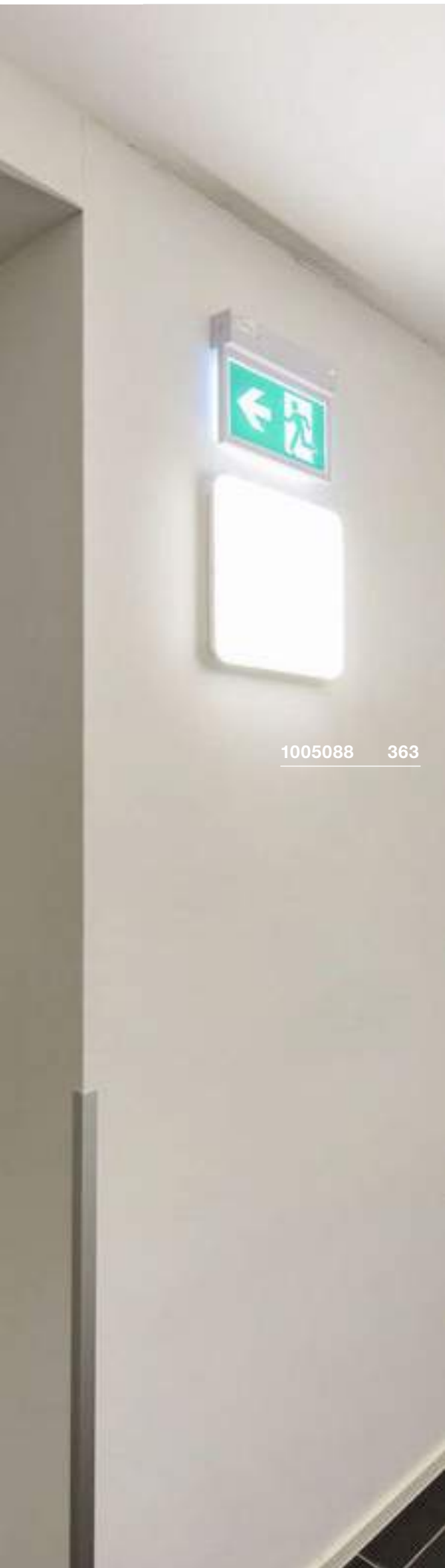

1005088 363

**SIMA**  
CW, square, PHASE



- Flat, robust construction
- With spacer for cable surface mounting
- Contains recycled material

**Product details**

220-240V ~50/60Hz | 350mA  
Total wattage: 24W  
Material: Polycarbonate (PC)  
Dimmable: C, L

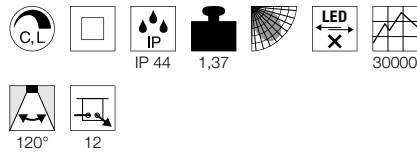

**Dimensional drawing**

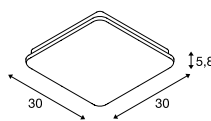

**SIMA**  
CW, square, Sensor



- Flat, robust construction
- With spacer for cable surface mounting
- Motion detector with MR (microwave) technology integrated in light housing
- Contains recycled material

**Product details**

220-240V ~50/60Hz | 350mA  
Total wattage: 24W  
Material: Polycarbonate (PC)

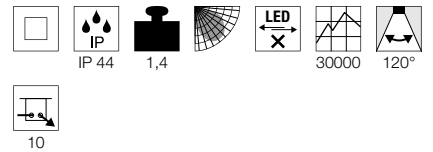

**Dimensional drawing**

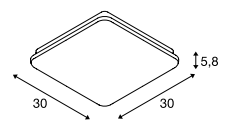

Variant	Item No.
2150lm   3000K   CRI>90 □ white	1005087

Variant	Item No.
2150lm   3000K   CRI>90 □ white	1005088

1001316 365





1001317 365

**IMPERVA 120**  
CW



**IMPERVA 150**  
CW



- High IR protection rating
- Exceptionally resilient light housing

- High IR protection rating
- Exceptionally resilient light housing

**Product details**

220-240V ~50/60Hz | 700mA  
Total wattage: 40W  
Material: Polycarbonate (PC)

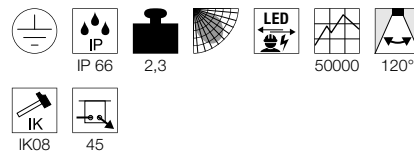

**Product details**

220-240V ~50/60Hz | 1050mA  
Total wattage: 55W  
Material: Polycarbonate (PC)

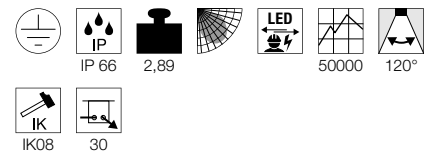

**Dimensional drawing**

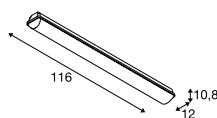

**Tip**

Chain and cable not included

**Dimensional drawing**

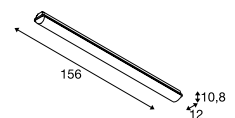

**Tip**

Chain and cable not included

Variant	Item No.
4200lm   3000K   CRI>80	
■ grey	<b>1001314</b>
400lm · 4000K · CRI>80	
■ grey	<b>1001315</b>

Variant	Item No.
6600lm   3000K   CRI>80	
■ grey	<b>1001316</b>
7100lm   4000K   CRI>80	
■ grey	<b>1001317</b>

**SENSER**  
CW, square, PHASE



1004705 366

**Product details**

220-240V ~50/60Hz  
Material: aluminium  
Dimmable: C

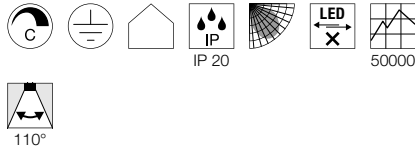

**SENSER 12**  
CW, square, PHASE

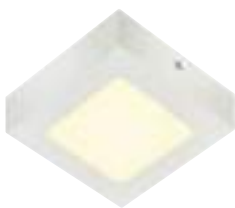

**Dimensional drawing**

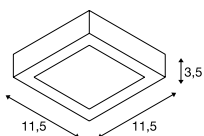

Variant	Item No.
480lm   3000K   CRI>80   8.2W   0.27 kg □ white	<b>1003017</b>
440lm   4000K   CRI90   8.5W   0.27 kg □ white	<b>1004703</b>

**SENSER 18**  
CW, square, PHASE



**Dimensional drawing**

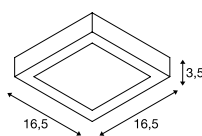

Variant	Item No.
880lm   3000K   CRI>80   12W   0.39 kg □ white	<b>1003018</b>
880lm   4000K   CRI90   13W   0.39 kg □ white	<b>1004704</b>

**SENSER 24**  
CW, square, PHASE



**Dimensional drawing**

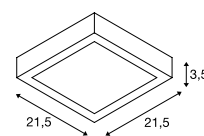

Variant	Item No.
1200lm   3000K   CRI>80   15W   0.5 kg □ white	<b>1003019</b>
1200lm   4000K   CRI90   15W   0.5 kg □ white	<b>1004705</b>

**SENSER**  
CW, round, PHASE



**Product details**

220-240V ~50/60Hz  
Material: aluminium  
Dimmable: C

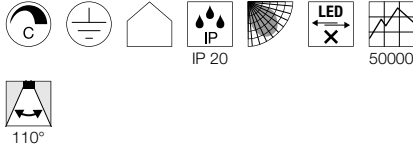

**SENSER 12**  
CW, round, PHASE



**Dimensional drawing**

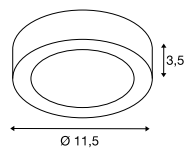

Variant	Item No.
480lm   3000K   CRI>80   8.2W   0.23 kg □ white	<b>1003014</b>
470lm   4000K   CRI90   8.5W   0.23 kg □ white	<b>1004700</b>

**SENSER 18**  
CW, round, PHASE



**Dimensional drawing**

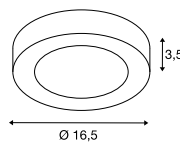

Variant	Item No.
880lm   3000K   CRI>80   12W   0.34 kg □ white	<b>1003015</b>
990lm   4000K   CRI90   13W   0.34 kg □ white	<b>1004701</b>

**SENSER 24**  
CW, round, PHASE



**Dimensional drawing**

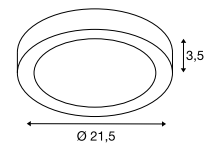

Variant	Item No.
1200lm   3000K   CRI>80   15W   0.47 kg □ white	<b>1003016</b>
1300lm   4000K   CRI90   15W   0.47 kg □ white	<b>1004702</b>



BENA Video



[bit.ly/slv-bena](https://bit.ly/slv-bena)







631347 369



631339 369

**BENA 120**  
CW



- Easy installation

**Product details**

220-240V ~50/60Hz | 700mA  
Total wattage: 28W  
Material: Polymethylacrylate (PMMA)/steel



**Dimensional drawing**

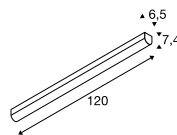

**BENA 150**  
CW



- Easy installation

**Product details**

220-240V ~50/60Hz | 700mA  
Total wattage: 38W  
Material: Polymethylacrylate (PMMA)/steel



**Dimensional drawing**

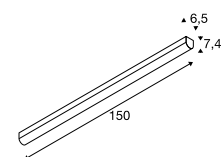

Variant	Item No.
3200lm   3000K   CRI>80 □ white	631337
3400lm   4000K   CRI>80 □ white	631347

Variant	Item No.
4400lm   3000K   CRI>80 □ white	631339
400lm · 4000K · CRI>80 □ white	631349

SIGHT 60  
CW

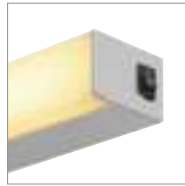

• Switch on light housing

Product details

220-240V ~50/60Hz | 700mA  
Total wattage: 20W  
Material: aluminium/acrylic

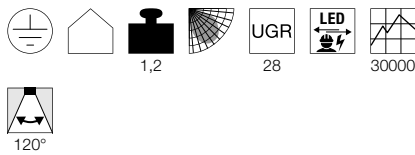

Dimensional drawing

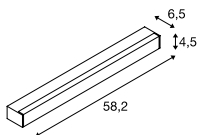

SIGHT 115  
CW

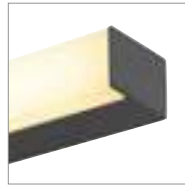
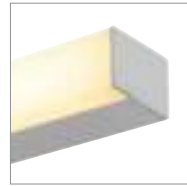

Product details

220-240V ~50/60Hz | 700mA  
Total wattage: 37.3W  
Material: aluminium/acrylic

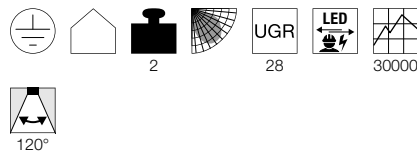

Dimensional drawing

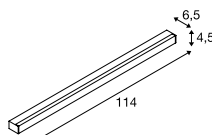

1001286 370



Variant	Item No.
1490lm   3000K   CRI>80	
■ black	1001283
1490lm   3000K   CRI>80	
□ white	1001284
1490lm   3000K   CRI>80	
■ grey	1001285

Variant	Item No.
3100lm   3000K   CRI>80	
■ black	1001286
3100lm   3000K   CRI>80	
□ white	1001287
3100lm   3000K   CRI>80	
■ grey	1001288



1001020 371

LONG GRILL  
CW

- Lighting unit can be pivoted through 270°

## Product details

220-240V ~50/60Hz | 700mA  
Total wattage: 20W  
Material: aluminium/acrylic



1,25



30000



270°



110°

## Dimensional drawing

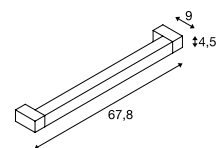

Variant	Item No.
1600lm   3000K   CRI>80	
■ black	1001020
1600lm   3000K   CRI>80	
□ white	1001019

P-LIGHT  
CW



Pictogram foil

Polypropylen (PP)  
B: 24 cm H: 13.1 cm



5-part pictogram set for insertion  
(left diagonal up/ left diagonal  
down/ right diagonal up/ right  
diagonal down/ up).  
1 piece

Variant	Item No.
■ green	240007



- 24 m perception distance
- Easy assembly
- Can be used flexibly - as ceiling-mounted or wall-mounted variant
- Flat emergency lighting with efficient LED technology
- 4-piece pictogram set included for insertion

Product details

220-240V ~50Hz  
Total wattage: 3.5W  
Material: ABS / Polycarbonate (PC)



Dimensional drawing

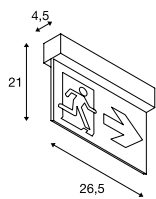

Tip

Perception distance 24 m. 3 escape route signs (right/left/down) and 1 white foil included. Emergency lighting with built-in Ni-Mh battery, with automatic self-test. Emergency operating time 3 hours. Luminance >15cd/m². Operating mode: Continuous operation/standby

Accessory recommendation

■ Accumulator 3,6V | 900mA  
Item No. 240020



■ Pictogram foil, set  
Item No. 240007



Variant	Item No.
32lm   6000K   CRI>70	
□ white	240000



240002 373



240000 372



240002 373

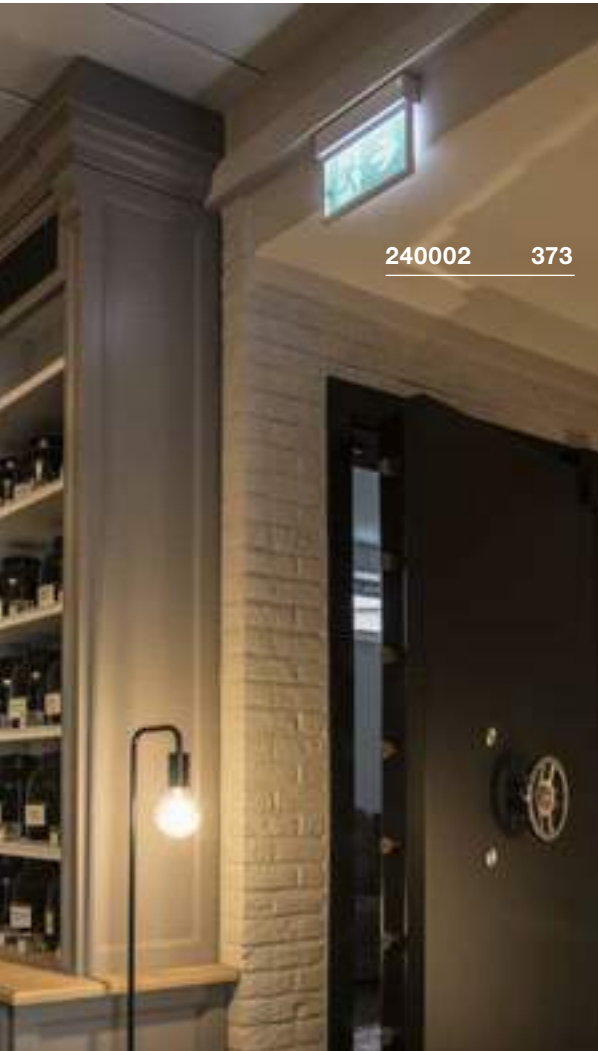

240002 373

**Pictogram foil**

Polypropylen (PP)  
B: 30 cm H: 16.1 cm

5-part pictogram set for insertion  
(left diagonal up/ left diagonal  
down/ right diagonal up/ right  
diagonal down/ up).  
1 piece



Variant	Item No.
■ green	240008



**P-LIGHT  
CW**



- 30 m perception distance
- Tested in line with DIN EN 60598-2-22
- Can be used flexibly - as ceiling-mounted or wall-mounted variant
- Very low maintenance costs thanks to efficient LED technology
- 4-piece pictogram set included for insertion
- Easy assembly

**Product details**

220-240V ~50/60Hz  
Total wattage: 4W  
Material: ABS / Polycarbonate (PC)



**Dimensional drawing**

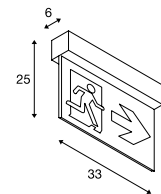

**Tip**

Perception distance 30 m. 3 escape route signs (right/left/down) and 1 white foil included. Emergency lighting with built-in Ni-Mh battery, with automatic self-test. Emergency operating time 3 hours. Luminance >15cd/m<sup>2</sup>. Operating mode: Continuous operation/standby

**Accessory recommendation**

Accumulator 3,6V | 1000mA

**Item No. 240021**

Pictogram foil, set

**Item No. 240008**



Variant	Item No.
32lm   6000K   CRI>70	
<input type="checkbox"/> white	240002

240000 372



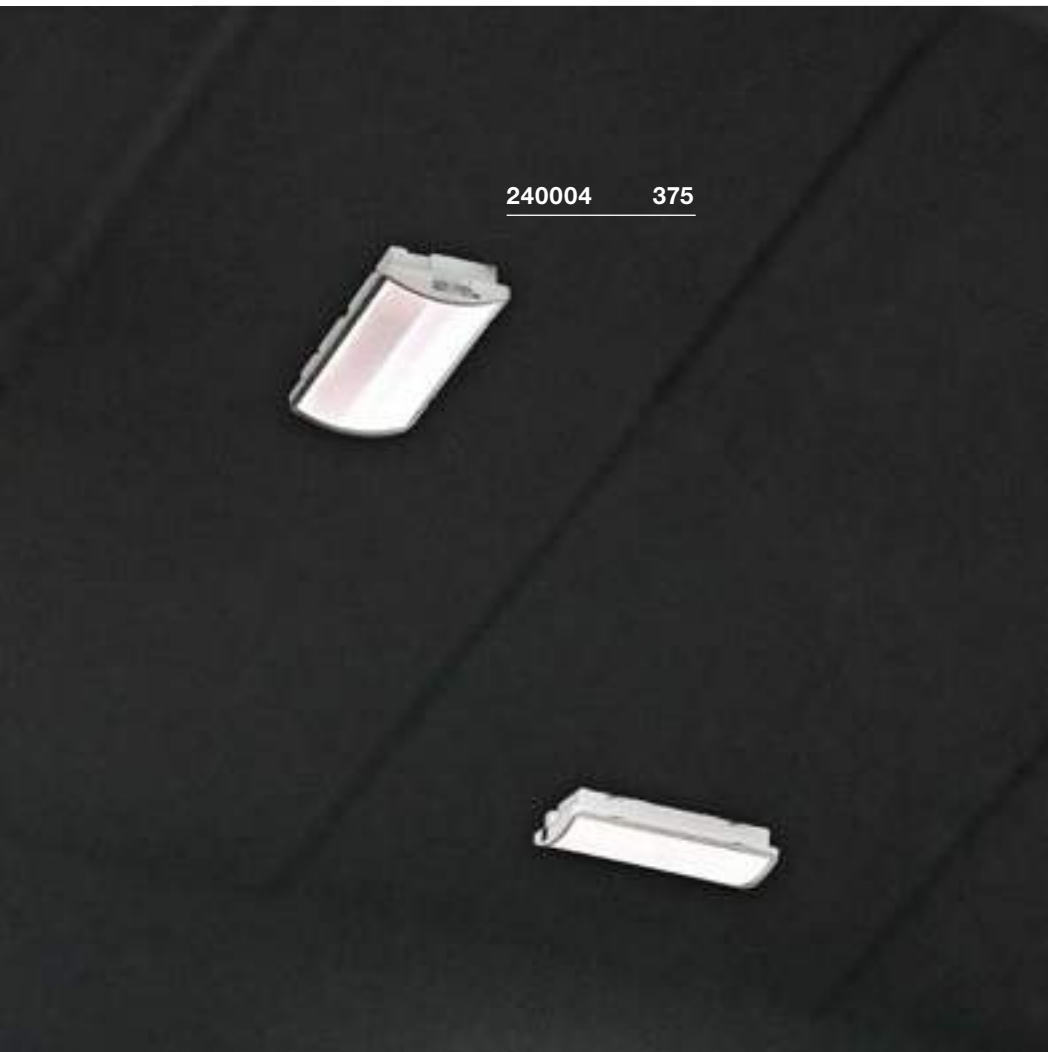

P-LIGHT  
CW



- 30 m perception distance
- IP 65 light with efficient LED technology
- Tested in line with DIN EN 60598-2-22
- Can be used flexibly - as ceiling-mounted or wall-mounted variant
- Easy assembly

Product details

220-240V ~50Hz  
Total wattage: 6.5W  
Material: Polycarbonate (PC)



Pictogram foil

Polypropylen (PP)  
W: 35.3 cm H: 16.5 cm



2-part pictogram set for inserting  
(right diagonal up/ right diagonal down)  
1 piece

Variant	Item No.
■ green	240010

Pictogram foil

Polypropylen (PP)  
W: 35.3 cm H: 16.5 cm



3-part pictogram set for inserting  
(above, below, right)  
1 piece

Variant	Item No.
■ green	240009



Dimensional drawing

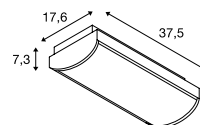

Tip

Perception distance 30 m. For use as emergency lighting. Auto-test function, Ni-Mh battery 2 x 3.6V 1.0Ah included Emergency operation via battery 2 hours. Escape route signs optionally available and can be used as emergency lights.

Accessory recommendation

□ Accumulator 3,6V | 1000mA, 2 units  
Item No. 240022

■ Pictogram foil, set  
Item No. 240009

■ Pictogram foil, set  
Item No. 240010



Variant	Item No.
100lm   6000K   CRI>70	
□ white	240004

# DEEP ROOTED.

## RECESSED FITTINGS RADIATE AN IMPRESSION.

---

Be it broad-beamed, flooded, static or swivelling: Recessed fittings are the core element of many lighting concepts, and provide a good alternative to freely suspended luminaires. You can adapt to any ambience and give yourself a great deal of furnishing freedom.







113171 414

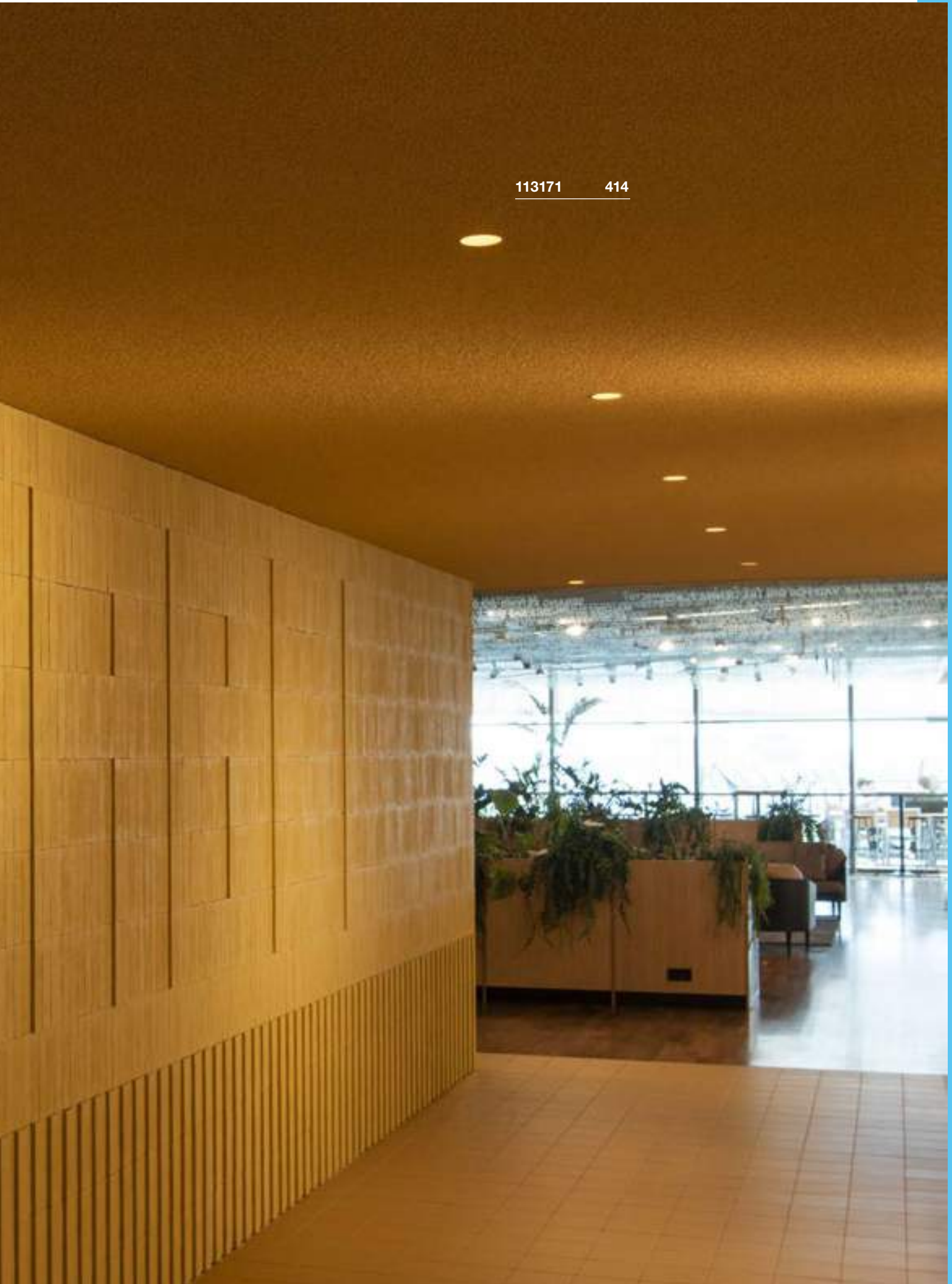

# OUR QUALITY PROMISE

## INNOVATION AND DEVELOPMENT

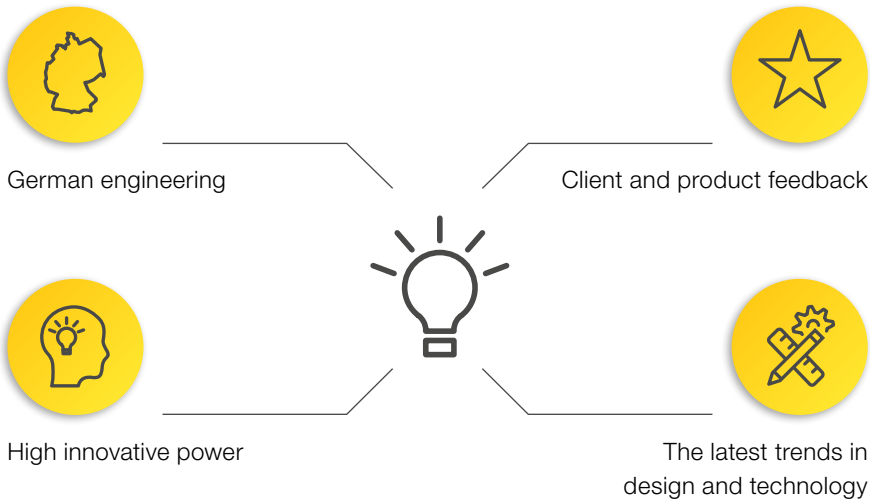

## MANUFACTURE

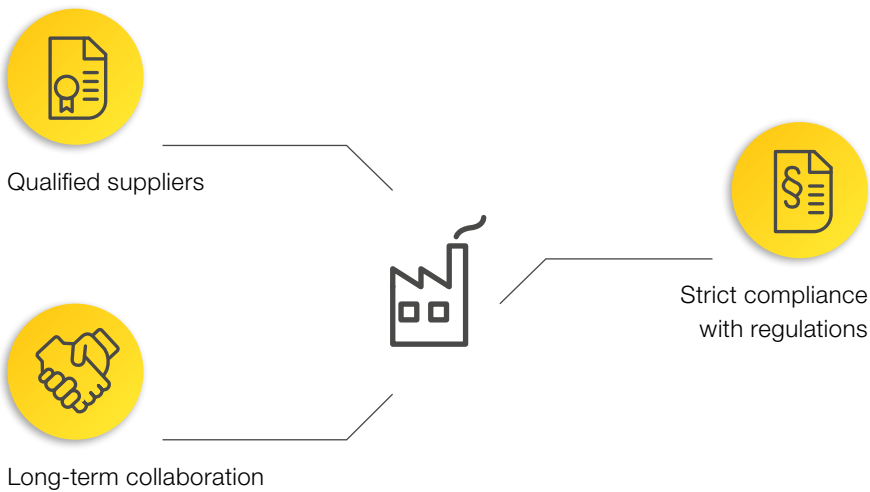

## QUALITY ASSURANCE

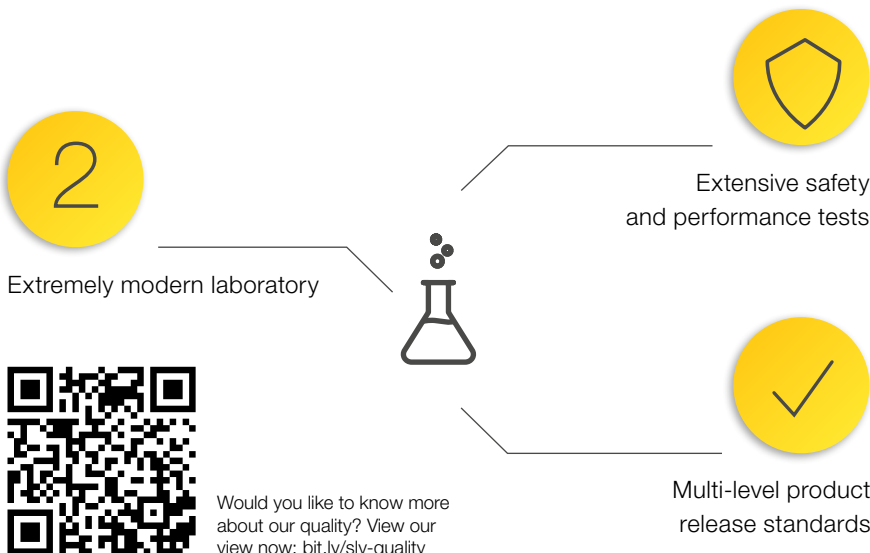

Would you like to know more about our quality? View our view now: [bit.ly/slv-quality](https://bit.ly/slv-quality)





### RECESSED LIGHTS

 382	 383	 383	 383	 385	 385	 385	 386
 386	 386	 388	 388	 389	 390	 390	 391
 391	 392	 393	 393	 394	 395	 396	 397
 397	 397	 399	 399	 399	 400	 400	 401
 402	 402	 403	 403	 404	 405	 406	 407
 407	 408	 408	 409	 409	 411	 411	 413
 413	 413	 414	 415	 415	 416	 416	 416
 420	 420	 421	 421	 422	 422	 423	 423
 424	 425	 425	 425	 426	 426	 427	 427
 428	 428	 429	 429	 430	 430	 431	 432
 433	 433	 433	 434	 434	 434	 435	 435

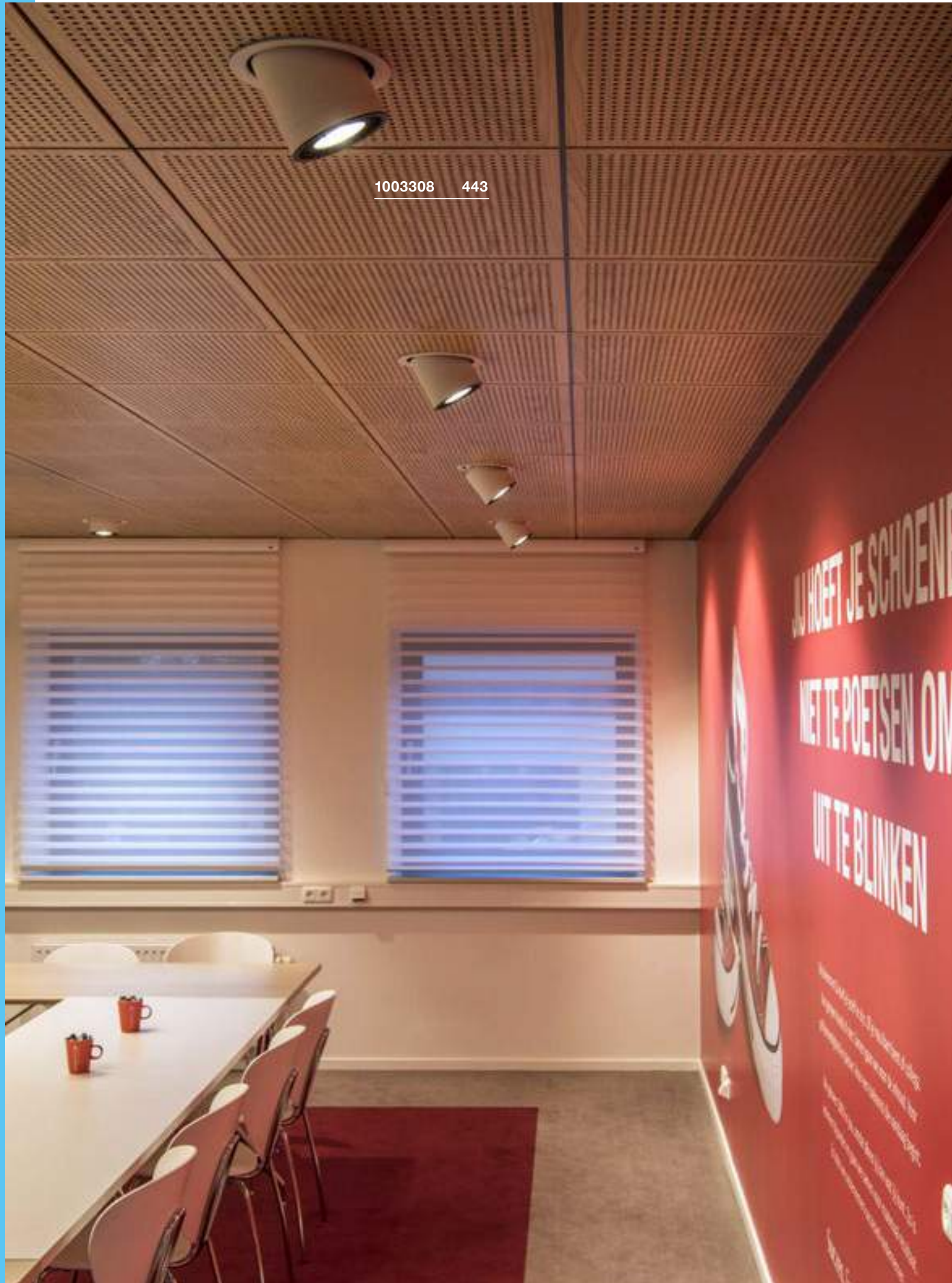

1003308 443

 436	 436	 436	 437	 437	 438	 438	 439
 440	 441	 442	 443	 445	 446	 446	 446
 447	 448	 448	 448	 449	 449	 449	 451
 451	 451	 452	 453	 453	 454	 455	 455
 455	 456	 456	 456	 457	 458	 459	 460
 461	 461	 461	 463	 463	 463	 463	



Other luminaires and variants can be found online at [www.slv.com](http://www.slv.com)  
 You can find manufacturer's details for our recommended lamps in the chapter 'Lightbulbs', from page 844



1002980 382

NOTAPO  
WL



Product details

700mA | 2.2W  
Material: aluminium



Dimensional drawing

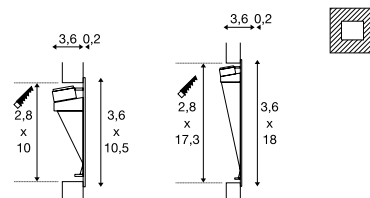

Tip

When connecting several lights, make sure they are connected in series!  
Open cable end  
Driver not included



151952 383

Accessory recommendation

- LED driver 700mA | 3W incl. strain relief  
Item No. 464200
- Installation frame  
Item No. 1002981



Variant	Item No.
6lm   3000K   CRI>90   H:10.5 cm   0.07 kg <input type="checkbox"/> white	1002979
6lm   3000K   CRI>90   H:18 cm   0.1 kg <input type="checkbox"/> white	1002980



DOWNUNDER PUR 80 EL



DOWNUNDER PUR 120 EL



DOWNUNDER PUR 150 EL



Product details

350mA | 3.6W  
Material: aluminium/steel



Dimensional drawing

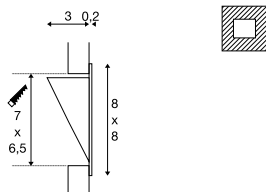

Tip

When connecting several lights, make sure they are connected in series!  
Material thickness of mounting surface: max. 15 mm  
MP connector incl./driver excl.

Product details

350mA | 3.6W  
Material: aluminium/steel



Dimensional drawing

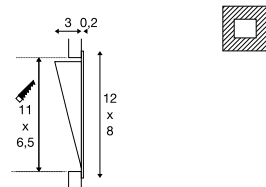

Tip

When connecting several lights, make sure they are connected in series!  
Material thickness of mounting surface: max. 15 mm  
AMP connector incl./driver excl.

Product details

500mA | 5.2W  
Material: aluminium/steel



Dimensional drawing

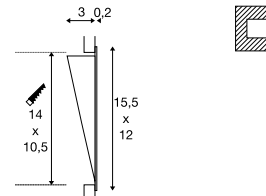

Tip

When connecting several lights, make sure they are connected in series!  
Material thickness of mounting surface: max. 15 mm  
AMP connector incl./driver excl.

Accessory recommendation

- LED driver 320mA | 10W  
Item No. 464140
- LED driver 350mA | 15W  
Item No. 1002803
- Installation frame  
Item No. 151960

Accessory recommendation

- LED driver 350mA | 15W  
Item No. 1002803
- LED driver 350mA | 9W  
Item No. 464109
- Installation frame  
Item No. 151961

Accessory recommendation

- LED driver 500mA | 15W dimmable  
Item No. 464144
- LED driver 500mA | 9W  
Item No. 464091
- Installation frame  
Item No. 151962

Variant	Item No.
180lm   3000K   CRI>80 <input type="checkbox"/> white	151950

Variant	Item No.
160lm   3000K   CRI>80 <input type="checkbox"/> white	151951

Variant	Item No.
230lm   3000K   CRI>80 <input type="checkbox"/> white	151952



1000575 385

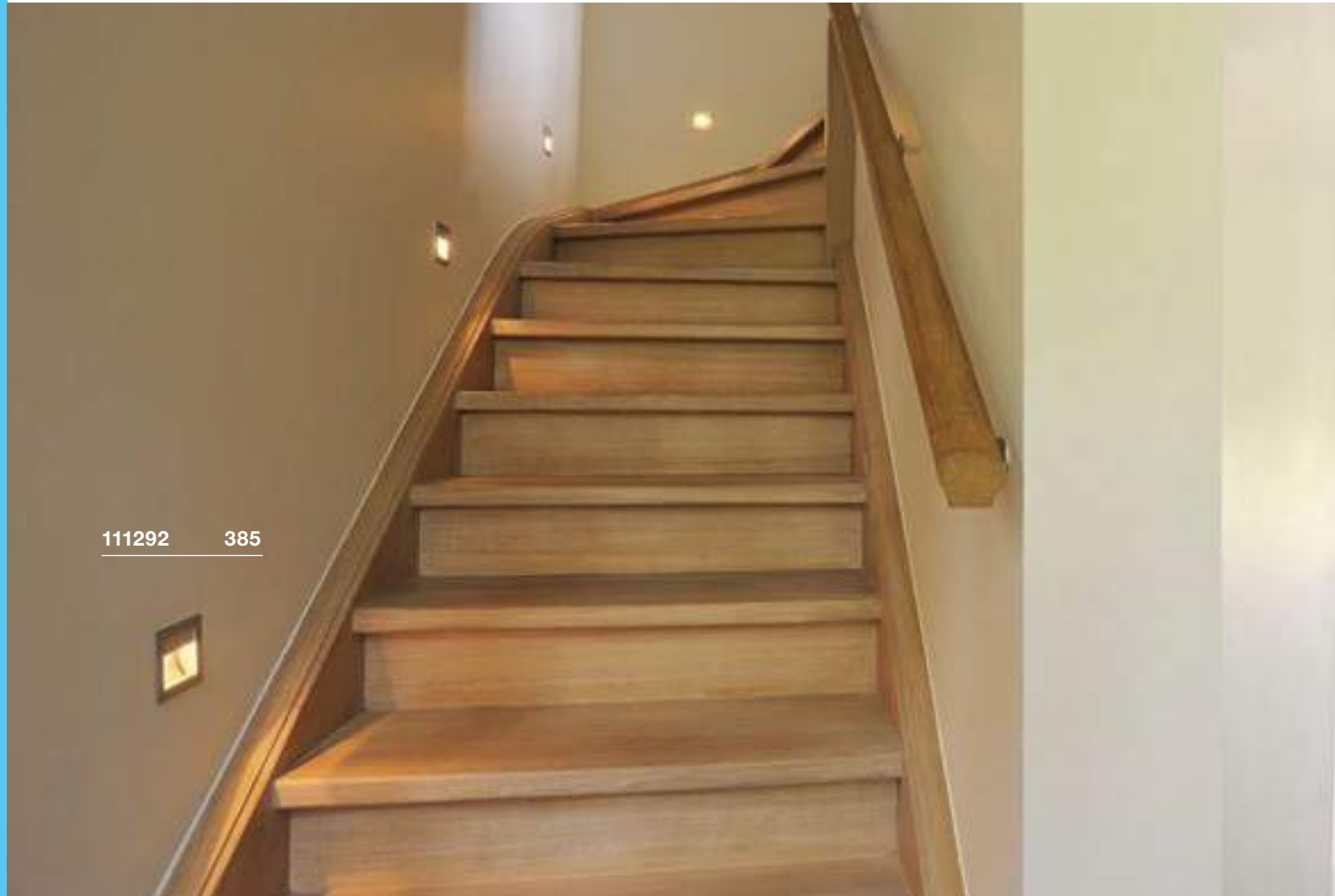

111292 385





**FLAT FRAME CURVE**  
EL, QT9

SOCKET  
INSIDE



**Product details**

12V ~50/60Hz  
Material: aluminium



0,15

**Dimensional drawing**

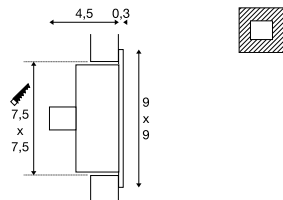

**Tip**

Material thickness of mounting surface:  
max. 10-25 mm  
Dimension drawing left with mounting box

**Accessory recommendation**

Transformer 12V AC | 60VA

Item No. 461060

Panel connection

Item No. 112781

Flush frame

Item No. 112780



**Lamp details**

max. 20W QT9

Variant	Item No.
G4   QT9	
white	112771
G4   QT9	
grey	112772

**FRAME CURVE**  
EL, HV

LED  
INSIDE



**Product details**

100-277V ~50/60Hz | 350mA  
Total wattage: 3.1W  
Material: aluminium



0,26

30000

250

**Dimensional drawing**

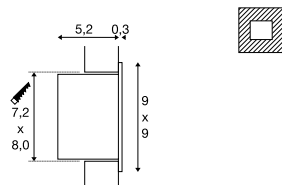

**Tip**

Material thickness of mounting surface:  
10-30 mm

**Accessory recommendation**

Panel connection

Item No. 112781

Flush frame

Item No. 112780



**FRAME CURVE**  
EL

LED  
INSIDE



**Product details**

350mA | 1W  
Material: aluminium



0,11

30000

**Dimensional drawing**

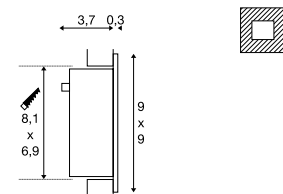

**Tip**

Material thickness of mounting surface:  
max. 10-30 mm. When connecting several lights,  
make sure that they are connected in series!  
AMP connector incl./driver excl.

**Accessory recommendation**

LED driver 350mA | 3W

Item No. 464107

Panel connection

Item No. 112781

Flush frame

Item No. 112780

Connector strip 3 outlets

Item No. 111850



Variant	Item No.
60lm   4000K   CRI>80	
grey	111290
60lm   3000K   CRI>80	
grey	111292
60lm   4000K   CRI>80	
white	113290
60lm   3000K   CRI>80	
white	113292

**FLAT FRAME BASIC**  
EL, QT9

SOCKET  
INSIDE



**Product details**

12V ~50/60Hz  
Material: aluminium/glass



0,15

**Dimensional drawing**

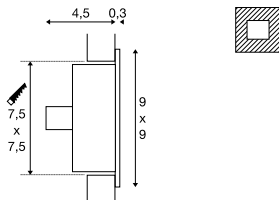

**Tip**

Material thickness of mounting surface:  
max. 10-25 mm  
Transformer not included

**Accessory recommendation**

Transformer 12V AC | 60VA

Item No. 461060

Flush frame

Item No. 112780

Panel connection

Item No. 112781



**Lamp details**

max. 20W QT9

Variant	Item No.
G4   QT9	
white	112731
G4   QT9	
grey	112732

**FRAME BASIC**  
EL, HV

LED  
INSIDE



**Product details**

100-277V ~50/60Hz | 350mA  
Total wattage: 3.1W  
Material: aluminium



0,26

30000 250

**Dimensional drawing**

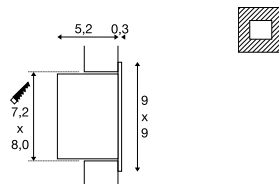

**Tip**

Material thickness of mounting surface:  
10-30 mm

**Accessory recommendation**

Flush frame

Item No. 112780

Panel connection

Item No. 112781



Variant	Item No.
140lm   2700K   CRI>80	
white	1000576
140lm   2700K   CRI>80	
grey	1000577

**FRAME BASIC**  
EL

LED  
INSIDE



**Product details**

350mA | 1W  
Material: aluminium/glass



0,23

30000

**Dimensional drawing**

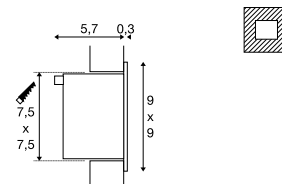

**Tip**

Material thickness of mounting surface:  
max. 10-30 mm  
When connecting several lights, make sure  
they are connected in series!  
AMP connector incl./driver excl.

**Accessory recommendation**

LED driver 350mA | 3W

Item No. 464107

Flush frame

Item No. 112780

Panel connection

Item No. 112781

Connector strip 3 outlets

Item No. 111850



Variant	Item No.
45lm   4000K   CRI>80	
grey	111260
40lm   3000K   CRI>80	
grey	111262
45lm   4000K   CRI>80	
white	113260
40lm   3000K   CRI>80	
white	113262

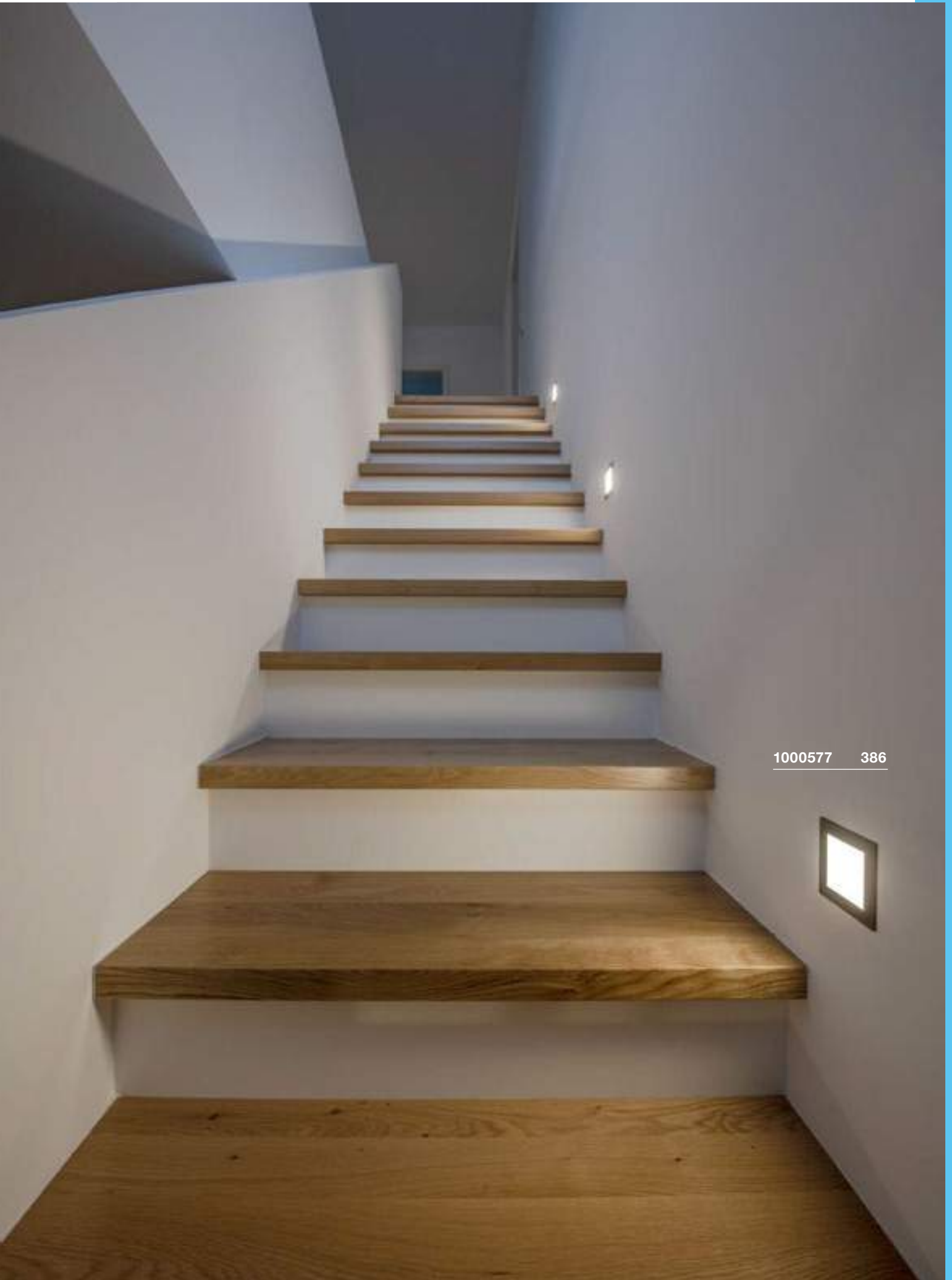

1000577 386

MOBALA  
EL



WORO  
EL



- Installation in standard switch box possible

Product details

100-240V ~50/60Hz | 24V DC  
Total wattage: 1.3W  
Material: aluminium



0,12 30000

Product details

350mA | 1.1W  
Material: steel



0,095 35 30000

Dimensional drawing

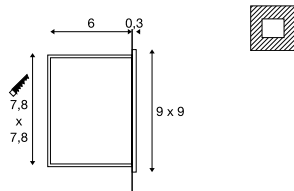

Dimensional drawing

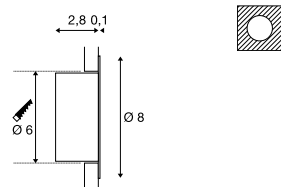

Tip

When connecting several lights, make sure they are connected in series!  
This article is suitable for installation in cavity walls and flush-mounted sockets for switches/sockets.  
Open cable end  
Driver not included

Accessory recommendation

- Panel connection  
Item No. 1002983
- Installation frame  
Item No. 1002984

Accessory recommendation

- LED driver 350mA | 9W  
Item No. 464109

Variant	Item No.
14lm   3000K   CRI>80 □ white	1002982

Variant	Item No.
50lm   3000K   CRI>80 □ white	1002922



1002982 388



1003466 389

QUAD FRAME 9  
WL

NEW

LED  
INSIDE

## Product details

100-277V ~50/60Hz | 350mA  
 Total wattage: 3W  
 Material: aluminium/aluminium  
 Installation dimensions:  
 B: 8 cm L: 7.2 cm T: 6.5 cm



0,37

30000

10

## Dimensional drawing

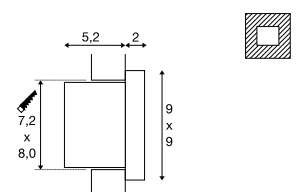

## Tip

Material thickness of mounting surface:  
 10-30 mm

## Accessory recommendation

■ Panel connection  
 Item No. 112781

Flush frame

Item No. 112780



Variant	Item No.
65lm   3000K   CRI>90 □ white	1003466

BEDSIDE  
EL, left



- "Dip-it" – Switch by swivelling
- With blue orientation light when off
- Implementation left

Product details

700mA | 3W  
Material: aluminium

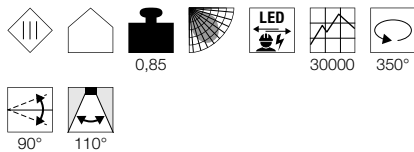

Dimensional drawing

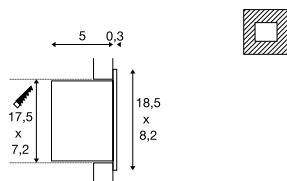

Tip

Not suitable for connection in series.  
Operate only with 3W driver (464200).  
Material thickness of mounting surface:  
max. 20 mm  
Driver not included

Accessory recommendation

LED driver 700mA |  
3W incl. strain relief  
**Item No. 464200**



Panel connection  
**Item No. 146260**



Variant	Item No.
110lm   3000K   CRI>80 ■ silver grey	146242 ▼

BEDSIDE  
EL, right



- "Dip-it" – Switch by swivelling
- With blue orientation light when off
- Implementation right

Product details

700mA | 3W  
Material: aluminium

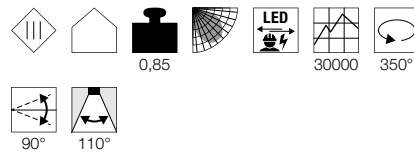

Dimensional drawing

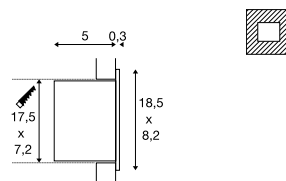

Tip

Not suitable for connection in series.  
Operate only with 3W driver (464200).  
Material thickness of mounting surface:  
max. 20 mm  
Driver not included

Accessory recommendation

LED driver 700mA |  
3W incl. strain relief  
**Item No. 464200**



Panel connection  
**Item No. 146260**



Variant	Item No.
110lm   3000K   CRI>80 ■ silver grey	146252 ▼

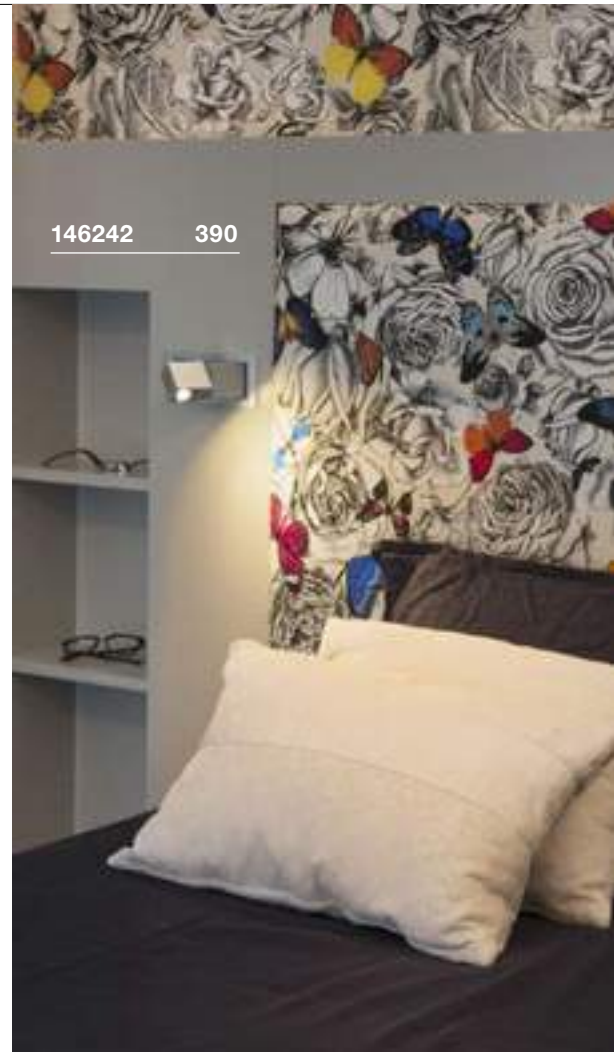

146242 390



146242 390



152381 391

**KARPO 30**  
EL



- Premium LED with CRI>90

**Product details**

500mA | 7.5W  
Material: aluminium/steel

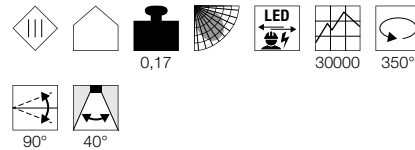

**Dimensional drawing**

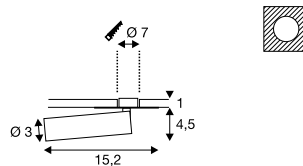

**Tip**

Material thickness of mounting surface:  
max. 12 mm  
When connecting several lights, make sure  
they are connected in series!  
Driver not included

**Accessory recommendation**

LED driver 500mA | 9W  
**Item No. 464091**



Variant	Item No.
450lm   3000K   CRI>90	
■ black	<b>152380</b>
470lm   3000K   CRI>90	
□ white	<b>152381</b>

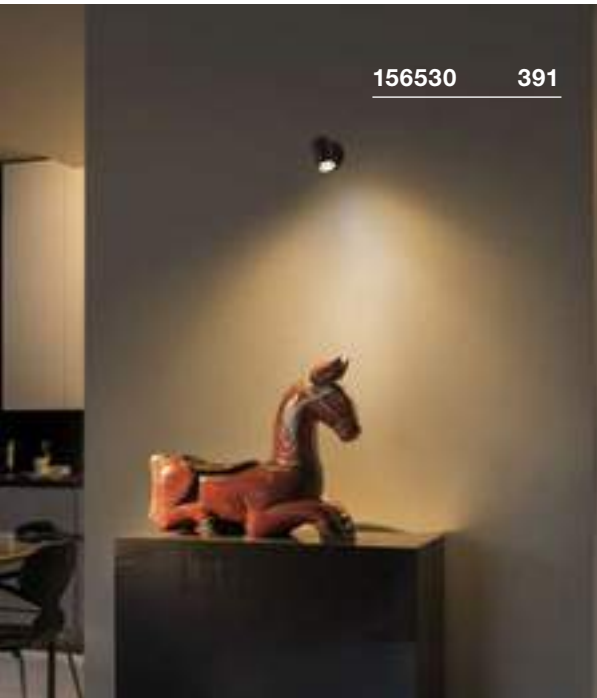

156530 391

**HELIA**  
EL



- Premium LED with CRI>90
- Low installation depth

**Product details**

500mA | 9W  
Material: aluminium

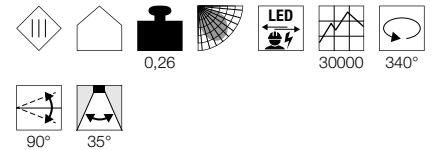

**Dimensional drawing**

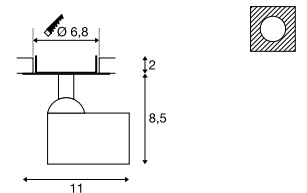

**Tip**

Material thickness of mounting surface:  
15 mm

**Accessory recommendation**

LED driver 500mA | 9W  
**Item No. 464091**



Variant	Item No.
700lm   3000K   CRI>90	
■ black	<b>156530</b>
800lm   3000K   CRI>90	
□ white	<b>156531</b>

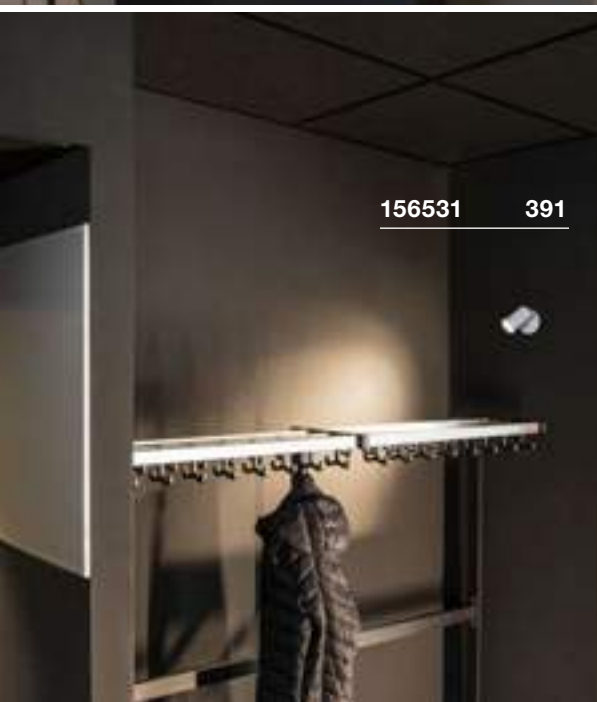

156531 391

# LIGHTPOINT EL

SOCKET  
INSIDE



1001156 392



## Product details

350mA | 1W  
Material: aluminium/polymethylacrylate (PMMA)

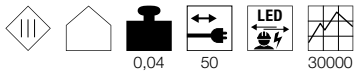

0,04 50 30000

## Dimensional drawing

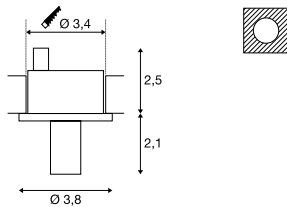

## Tip

When connecting several lights, make sure they are connected in series!  
Driver not included

## Accessory recommendation

■ Connector strip 3 outlets

Item No. 111850



□ LED driver 350mA | 3W

Item No. 464107



Variant	Item No.
100lm   3000K   CRI>80	
□ white	1001156
100lm   3000K   CRI>80	
■ chrome	1001155







112242 393



112222 393

DEKLED  
EL



Product details

350mA | 1W  
Material: aluminium/polycarbonate (PC)

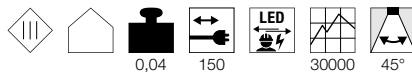

0,04 150 30000 45°

Dimensional drawing

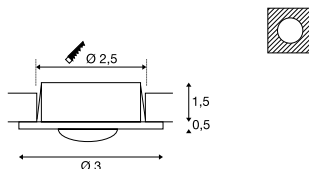

Tip

When connecting several lights, make sure they are connected in series!  
Driver not included

Accessory recommendation

LED driver 320mA | 3W incl. strain relief  
Item No. 464108



Variant	Item No.
60lm   4000K   CRI>80	
■ silver grey	112240
60lm   3000K   CRI>80	
■ silver grey	112242

DL 126  
EL



Product details

12V DC | 2.8W  
Material: aluminium/plastic

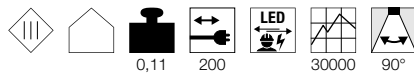

0,11 200 30000 90°

Dimensional drawing

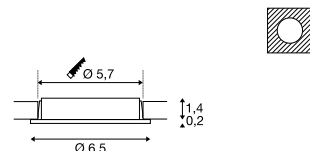

Accessory recommendation

LED power supply 12V DC | 12W  
Item No. 470507



Variant	Item No.
160lm   3000K   CRI>80	
□ white	112221
160lm   3000K   CRI>80	
■ chrome	112222
160lm   3000K   CRI>80	
■ silver grey	112225
160lm   2700K   CRI>80	
□ white	112161
160lm   2700K   CRI>80	
■ chrome	112162
160lm   2700K   CRI>80	
■ silver grey	112165

## PLASTRA

EL, round, QPAR51



SOCKET  
INSIDE



148070 394

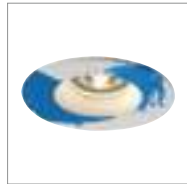

- Flush installation against ceiling possible
- Can be individually designed with colours, stickers & more

### Product details

220-240V ~50/60Hz  
Material: gypsum/steel

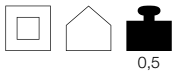

### Dimensional drawing

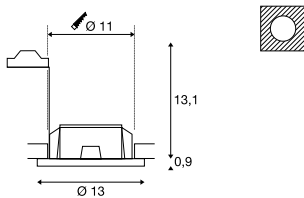

### Tip

Material thickness of mounting surface:  
max. 25 mm

### Recommended lamp

LED GU10 6W 36°  
3000K 460lm  
6kWh/1000h  
Item No. 1005079



LED GU10 4W 36°  
3000K 300lm  
4kWh/1000h  
Item No. 1004973



### Lamp details

max. 35W QPAR51

Variant	Item No.
GU10   QPAR51 □ matt white	148070





148071 395

**PLASTRA**  
EL, square, QPAR51**SOCKET**  
**INSIDE**

- Flush installation against ceiling possible
- Can be individually designed with colours, stickers & more

**Product details**220-240V ~50/60Hz  
Material: gypsum/steel

0,6

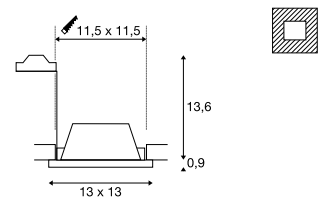
**Dimensional drawing****Tip**Material thickness of mounting surface:  
max. 25 mm**Recommended lamp**LED GU10 6W 36°  
2700K 460lm  
6kWh/1000h  
**Item No. 1005076**LED GU10 4W 36°  
2700K 300lm  
4kWh/1000h  
**Item No. 1004972****Lamp details**

max. 35W QPAR51

Variant	Item No.
GU10   QPAR51	
□ matt white	148071

## PIKA

EL, round, QPAR51, rigid

SOCKET  
INSIDE



- 3-pole loop-in/loop-out (for through wiring)

### Product details

230V -50Hz  
Material: aluminium



0,12 10

### Dimensional drawing

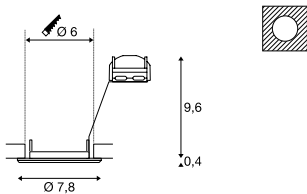

### Tip

Material thickness of mounting surface:  
max. 13 mm

### Recommended lamp

LED GU10 5.5W 38°  
2700K 400lm  
6kWh/1000h  
Item No. 1001030



LED GU10 6W 36°  
3000K 460lm  
6kWh/1000h  
Item No. 1005080



### Lamp details

max. 50W QPAR51

Variant	Item No.
GU10   QPAR51 white	1000714
GU10   QPAR51 chrome	1000715
GU10   QPAR51 brass	1000716
GU10   QPAR51 silver grey	1000717



**PIKA**  
EL, round, QPAR51

SOCKET  
INSIDE



- 3-pole loop-in/loop-out (for through wiring)
- Lighting unit can be pivoted through 30°

**Product details**

230V -50Hz  
Material: aluminium



0,14 10 30°

**Dimensional drawing**

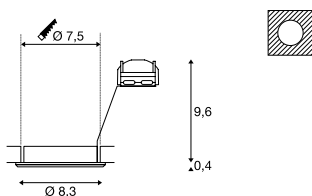

**Tip**

Material thickness of mounting surface:  
max. 15 mm

**Recommended lamp**

LED GU10 5.5W 38°  
2700K 400lm  
6kWh/1000h  
Item No. 1001030



LED GU10 6W 36°  
3000K 460lm  
6kWh/1000h  
Item No. 1005078



**Lamp details**

max. 50W QPAR51

Variant	Item No.
GU10   QPAR51 white	1000718
GU10   QPAR51 chrome	1000719
GU10   QPAR51 brass	1000720
GU10   QPAR51 silver grey	1000721

**PIKA**  
EL, square, QPAR51, rigid

SOCKET  
INSIDE

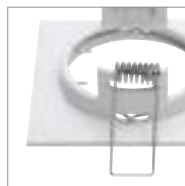

- 3-pole loop-in/loop-out (for through wiring)

**Product details**

230V -50Hz  
Material: aluminium



0,12 10

**Dimensional drawing**

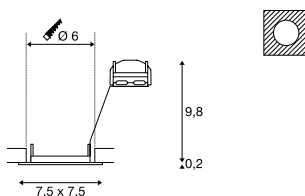

**Tip**

Material thickness of mounting surface:  
max. 13 mm

**Recommended lamp**

LED GU10 3,7W 36°  
2700K 260lm  
4kWh/1000h  
Item No. 560122



LED 6W 36°  
2700K 460lm  
6kWh/1000h  
Item No. 1005075



**Lamp details**

max. 50W QPAR51

Variant	Item No.
GU10   QPAR51 white	1002204
GU10   QPAR51 chrome	1002205
GU10   QPAR51 brass	1002206
GU10   QPAR51 silver grey	1002207

**PIKA**  
EL, square, QPAR51,  
swivelling

SOCKET  
INSIDE



- 3-pole loop-in/loop-out (for through wiring)
- Lighting unit can be pivoted through 30°

**Product details**

230V -50Hz  
Material: aluminium



0,12 10 30°

**Dimensional drawing**

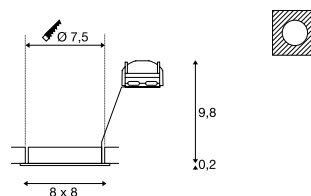

**Tip**

Material thickness of mounting surface:  
max. 15 mm

**Recommended lamp**

LED GU10 4W 36°  
2700K 300lm  
4kWh/1000h  
Item No. 1004972



LED GU10 4W 36°  
3000K 300lm  
4kWh/1000h  
Item No. 1004973



**Lamp details**

max. 50W QPAR51

Variant	Item No.
GU10   QPAR51 white	1002208
GU10   QPAR51 chrome	1002209
GU10   QPAR51 brass	1002210
GU10   QPAR51 silver grey	1002211

1003036 399



161301 399



1003039 399



**CONTONE®**  
EL, round/square, adjustable, PHASE



- Premium LED with CRI>90
- The light colour alters when dimmed

**Product details**

220-240V ~50/60Hz | 350mA  
Total wattage: 16W  
Material: aluminium  
Dimmable: C, L

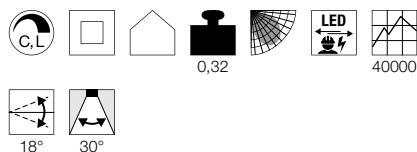

**Dimensional drawing**

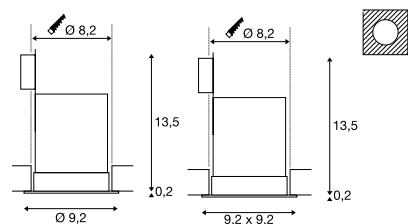

**Tip**

Material thickness of mounting surface:  
max. 25 mm

Variant	Item No.
890lm   2000K-3000K   CRI>90	
○ □ white	<b>161271</b>
890lm   2000K-3000K   CRI>90	
□ □ white	<b>161281</b>

**CONTONE®**  
EL, round/square, rigid, PHASE

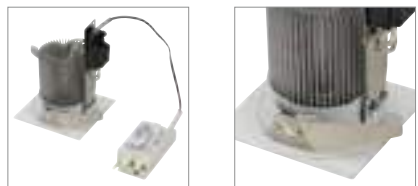

- Premium LED with CRI>90
- The light colour alters when dimmed

**Product details**

220-240V ~50/60Hz | 350mA  
Total wattage: 16W  
Material: aluminium  
Dimmable: C, L

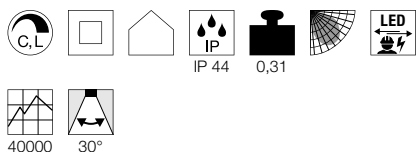

**Dimensional drawing**

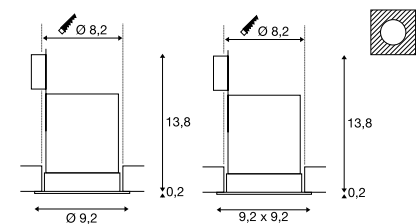

**Tip**

Material thickness of mounting surface:  
max. 25 mm

Variant	Item No.
890lm   2000K-3000K   CRI>90	
○ □ white	<b>161291</b>
890lm   2000K-3000K   CRI>90	
□ □ white	<b>161301</b>

**DINGILO**  
EL, round, adjustable



- Premium LED with CRI>90

**Product details**

100-277V ~50/60Hz | 200mA  
Total wattage: 4.4W  
Material: aluminium/plastic

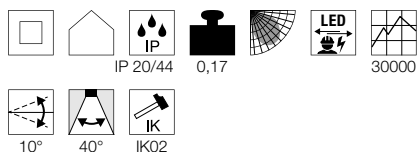

**Dimensional drawing**

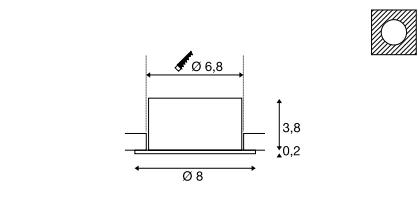

**Tip**

Material thickness of mounting surface:  
max. 25 mm

Variant	Item No.
330lm   2700K   CRI>90	
■ black	<b>1003036</b>
330lm   2700K   CRI>90	
□ white	<b>1003037</b>
330lm   3000K   CRI>90	
■ black	<b>1003038</b>
330lm   3000K   CRI>90	
□ white	<b>1003039</b>

H-LIGHT  
EL, round, PHASE



- Narrow rotationally symmetrical light distribution for accentuated illumination
- Generation of contoured light cones on vertical surfaces

Product details

220-240V ~50/60Hz | 500mA  
Total wattage: 11W  
Material: aluminium  
Dimmable: C, L

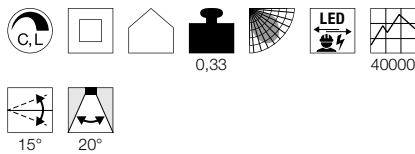

Dimensional drawing

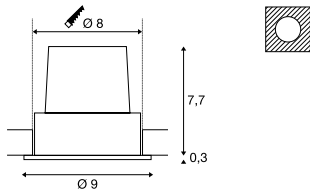

Tip

Material thickness of mounting surface:  
max. 30 mm

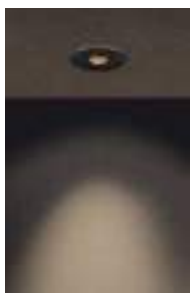

Variant	Item No.
265lm   2700K   CRI>80 ■ black	114480
265lm   2700K   CRI>80 □ white	114481

H-LIGHT  
EL, oval, PHASE



- Narrow asymmetrical light distribution for accentuated illumination
- Generation of contoured light cones on vertical surfaces

Product details

220-240V ~50/60Hz | 500mA  
Total wattage: 11W  
Material: aluminium  
Dimmable: C, L

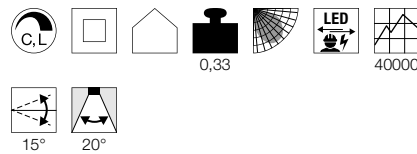

Dimensional drawing

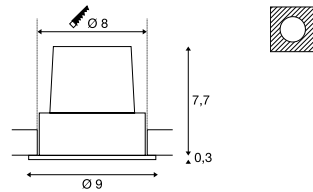

Tip

Material thickness of mounting surface:  
max. 30 mm

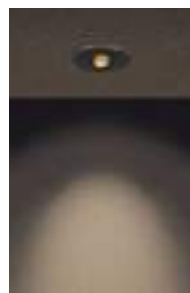

Variant	Item No.
395lm   2700K   CRI>80 ■ black	114490
395lm   2700K   CRI>80 □ white	114491

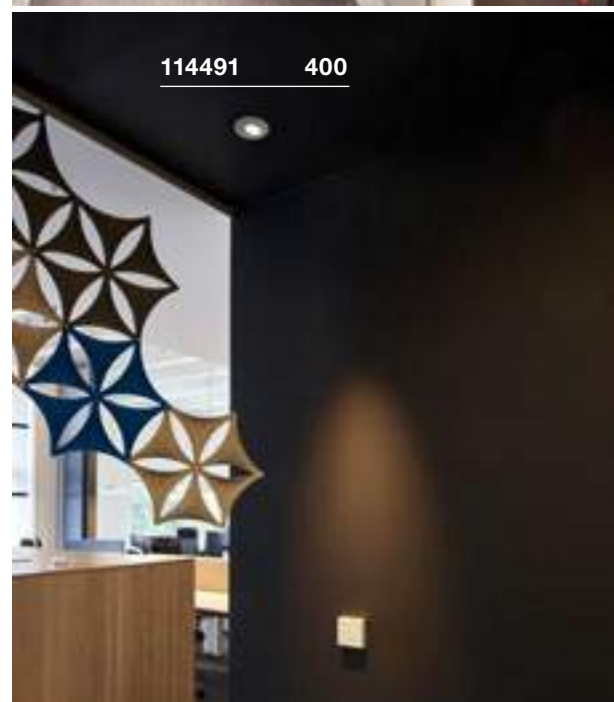
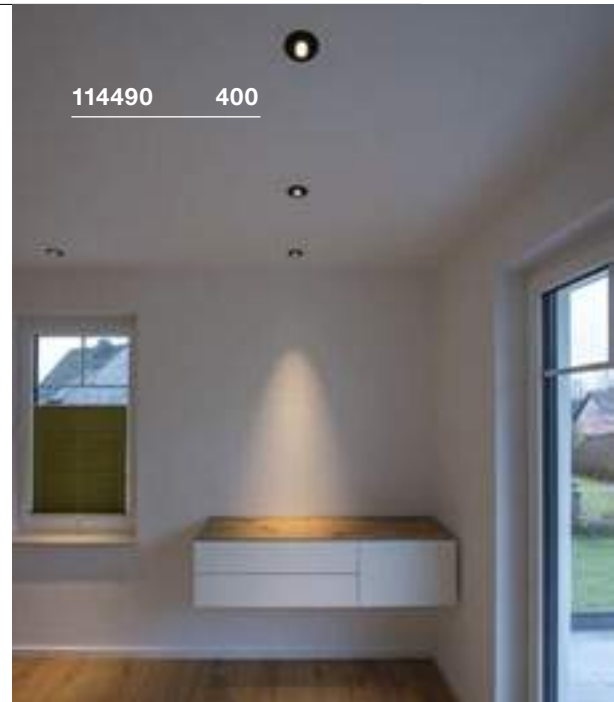



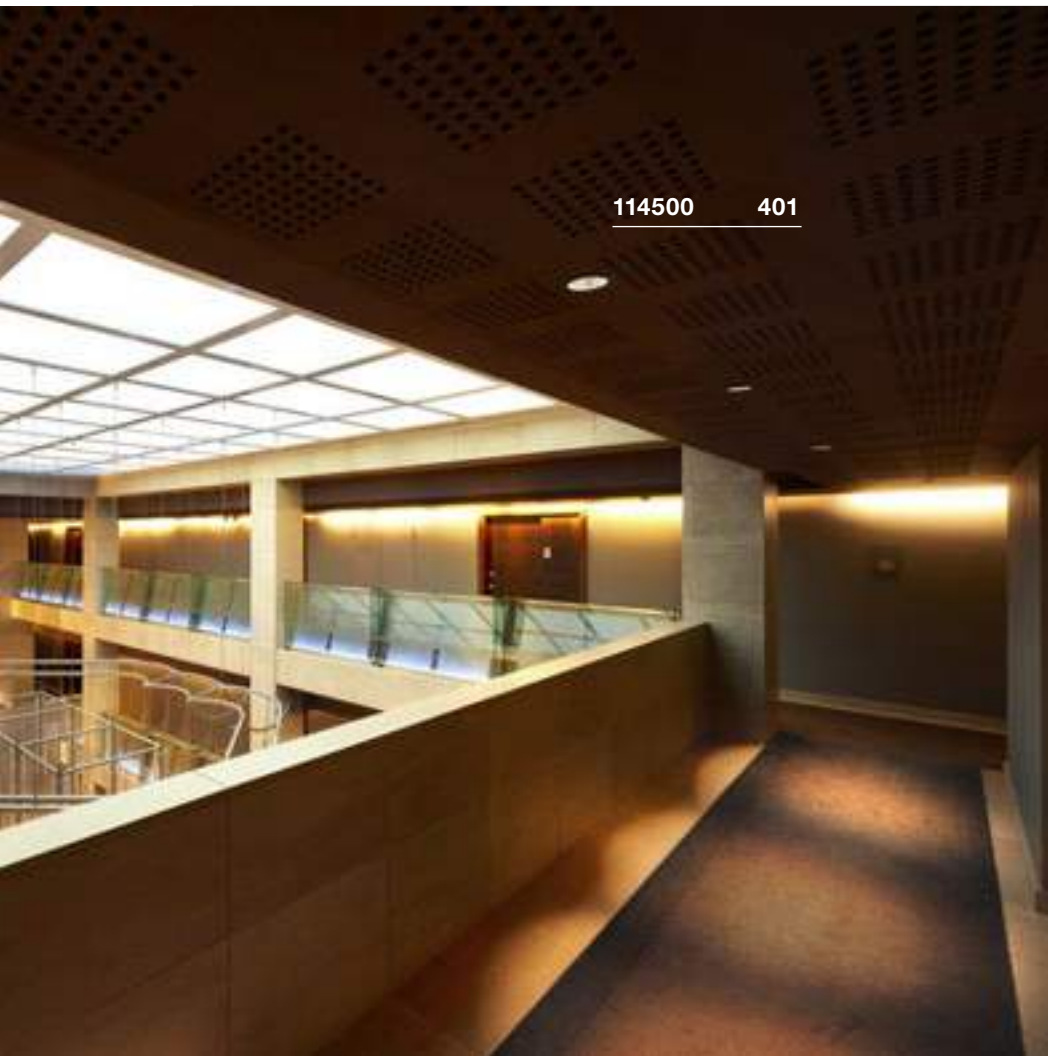

114500 401

H-LIGHT  
EL, PHASE



- Narrow rotationally symmetrical light distribution for accentuated illumination
- Generation of contoured light cones on vertical surfaces

Product details

220-240V ~50/60Hz | 500mA  
 Total wattage: 11W  
 Material: aluminium  
 Dimmable: C, L

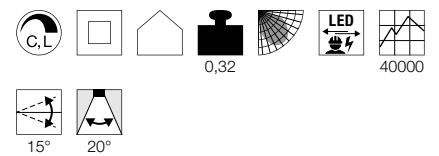

Dimensional drawing

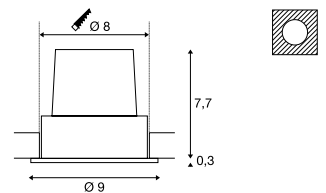

Tip

Material thickness of mounting surface:  
 max. 30 mm

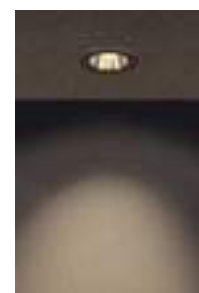

114500 401

Variant	Item No.
540lm   2700K   CRI>80	
■ black	114500
540lm   2700K   CRI>80	
□ white	114501

**DOLIX OUT**  
EL, round, QPAR51



**Product details**

220-240V ~50/60Hz  
Material: aluminium/glass

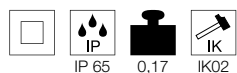

**Dimensional drawing**

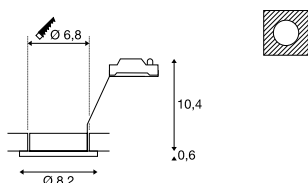

**Tip**

Material thickness of mounting surface:  
max. 20 mm

**Recommended lamp**

LED GU10 5.5W 38°  
2700K 400lm  
6kWh/1000h  
**Item No. 1001030**



LED 6W 36°  
2700K 460lm  
6kWh/1000h  
**Item No. 1005075**



**Lamp details**

max. 50W QPAR51

Variant	Item No.
GU10   QPAR51 □ white	<b>1001165</b>
GU10   QPAR51 ■ chrome	<b>1001166</b>
GU10   QPAR51 ■ silver grey	<b>1001167</b>
GU10   QPAR51 ■ brushed chrome	<b>1001168</b>

**DOLIX OUT**  
EL, square, QPAR51



**Product details**

220-240V ~50/60Hz  
Material: aluminium/glass

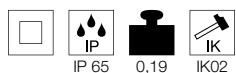

**Dimensional drawing**

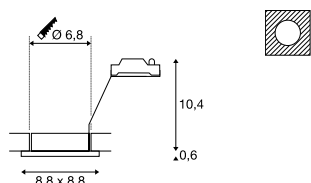

**Tip**

Material thickness of mounting surface:  
max. 20 mm

**Recommended lamp**

LED GU10 3,7W 36°  
2700K 260lm  
4kWh/1000h  
**Item No. 560122**



LED GU10 4W 36°  
2700K 300lm  
4kWh/1000h  
**Item No. 1004972**



**Lamp details**

max. 50W QPAR51

Variant	Item No.
GU10   QPAR51 □ white	<b>1001169</b>
GU10   QPAR51 ■ chrome	<b>1001170</b>
GU10   QPAR51 ■ silver grey	<b>1001171</b>
GU10   QPAR51 ■ brushed chrome	<b>1001172</b>



1001166 402

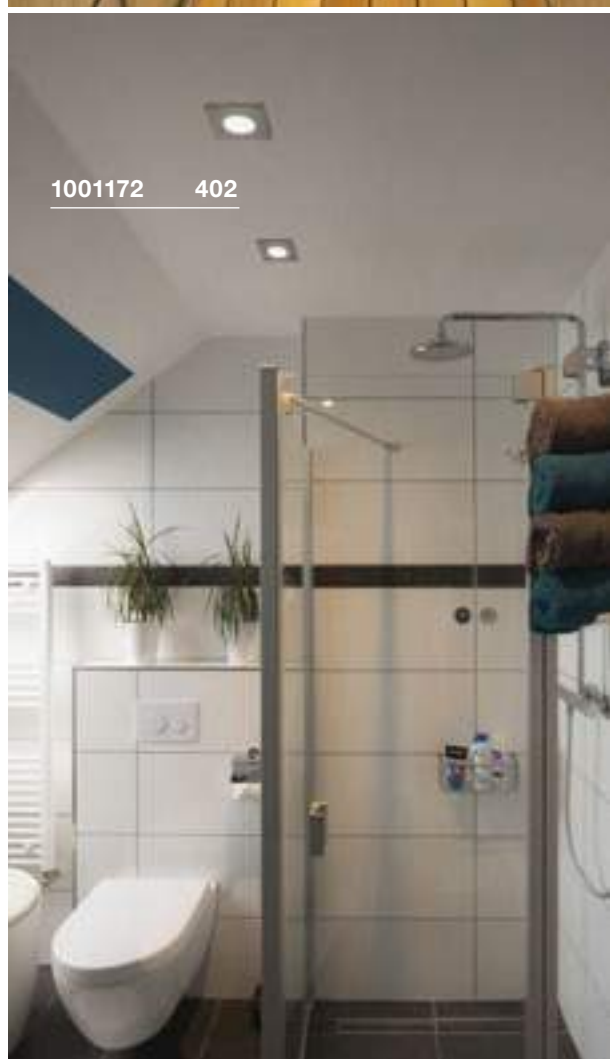

1001172 402



1001931 403



1001931 403

**VARU**  
EL, QPAR51

SOCKET  
INSIDE



- High IP rating
- Resilient housing

**Product details**

230V~50Hz  
Material: aluminium/glass

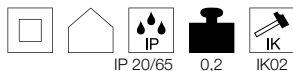

**Dimensional drawing**

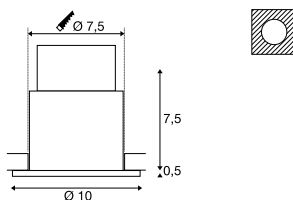

**Tip**

Material thickness of mounting surface:  
15 mm

**Recommended lamp**

LED GU10 3,7W 36°  
2700K 260lm  
4kWh/1000h  
Item No. 560122



LED GU10 4W 36°  
2700K 300lm  
4kWh/1000h  
Item No. 1004972



**Lamp details**

max. 5W LED GU10 51mm  
Diameter: 5 cm max.

Variant	Item No.
GU10   QPAR51	
■ black	1001930
GU10   QPAR51	
□ white	1001931

**VARU**  
EL

LED  
INSIDE



- High IP rating
- Resilient housing
- Glare reduction thanks to recessed LED

**Product details**

350mA | 5W  
Material: aluminium/glass



**Dimensional drawing**

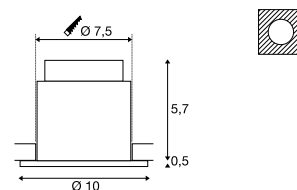

**Tip**

Material thickness of mounting surface:  
15 mm

**Accessory recommendation**

□ LED driver 350mA | 9W  
Item No. 464109



Variant	Item No.
400lm   2700K   CRI>80	
■ black	1001932
400lm   2700K   CRI>80	
□ white	1001933

KAMUELA ECO  
EL, round, PHASE



1001015 404



- Fire resistant for at least 90 minutes compliant with BS 476-21
- IP 65 light with efficient LED technology

Product details

220-240V ~50Hz  
Total wattage: 6.5W  
Material: aluminium/plastic  
Dimmable: C, L

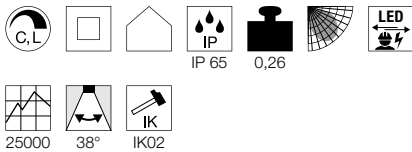

Dimensional drawing

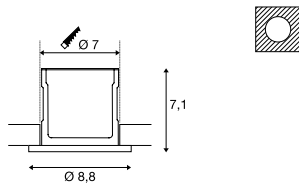

Tip

Material thickness of mounting surface:  
max. 40 mm

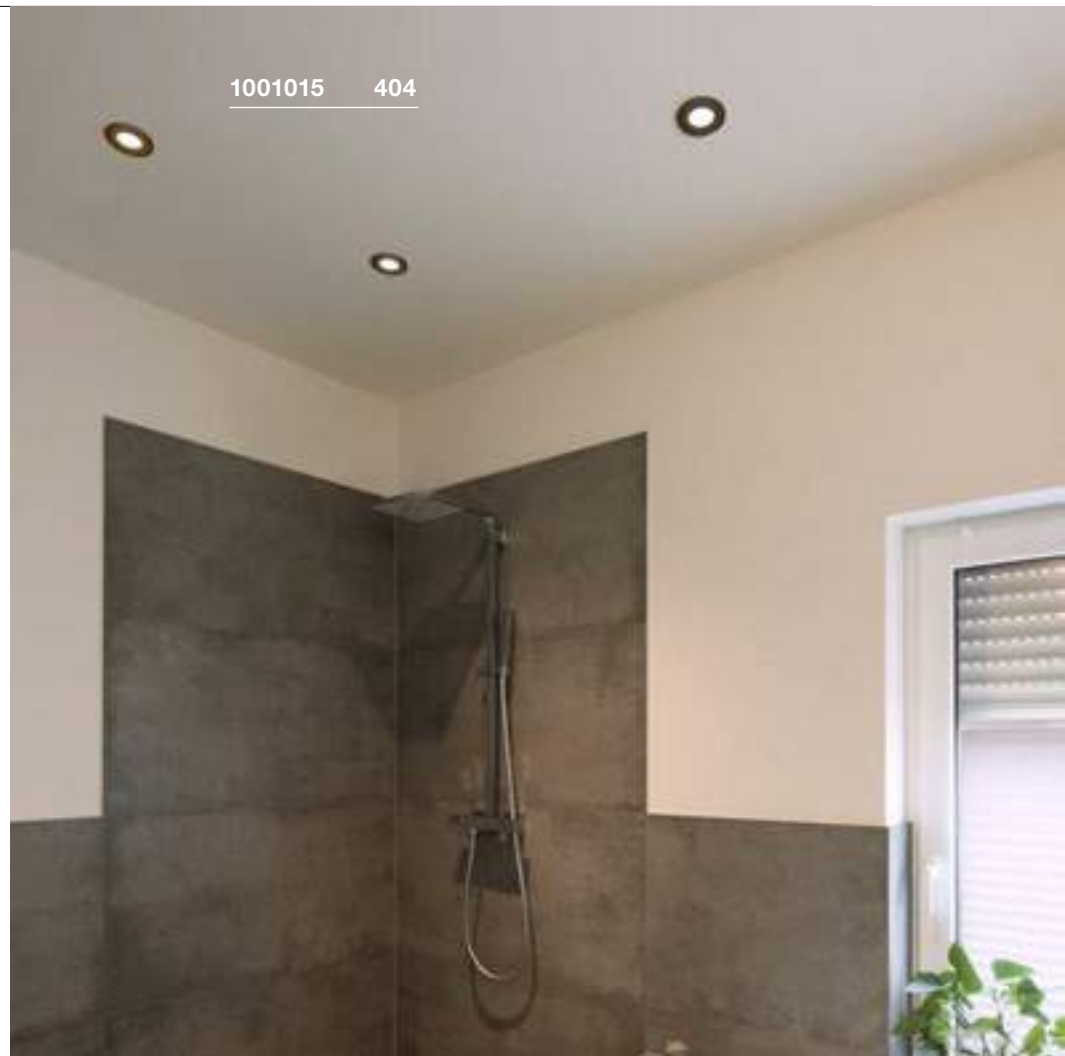

1001017 404

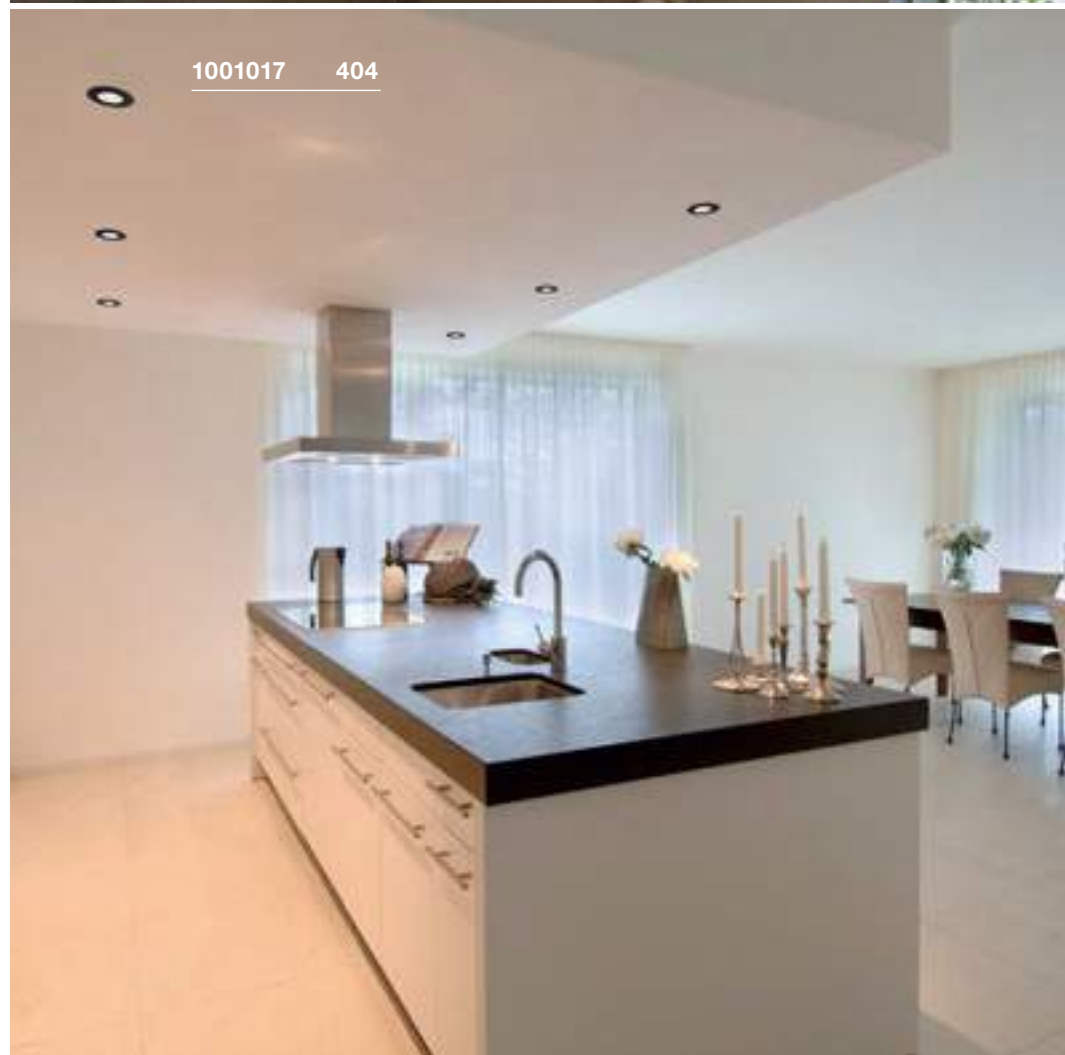

Variant	Item No.
400lm   3000K   CRI>80	
■ black	1001015
400lm   3000K   CRI>80	
□ white	1001016
400lm   4000K   CRI>80	
■ black	1001017
400lm   4000K   CRI>80	
□ white	1001018



240006 405

P-LIGHT  
ELLED  
INSIDE

- Tested in line with DIN EN 60598-2-22
- Recessed ceiling version with efficient LED technology

## Product details

220-240V ~50Hz

Total wattage: 5W

Material: ABS / Polycarbonate (PC)



0,37

25000

90°

## Dimensional drawing

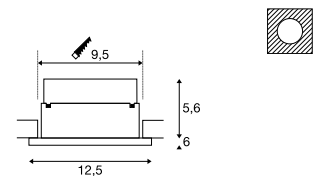

## Tip

Can be used as emergency lighting. Auto test function, Ni-Mh battery 2x 3,6V 1.5Ah included. Emergency operation via battery 3 hours. Half beam angle 90°, material thickness Installation surface: 25 mm max.

## Accessory recommendation

 Akkumulator 7.2V | 1000mA

Item No. 240024



Variant	Item No.
120lm   6000K   CRI>70	
<input type="checkbox"/> white	240006

AKALO D83  
EL, PHASELED  
INSIDE

CCT



1001264 406



- The light colour can be adjusted with the rear switch.

## Product details

220-240V ~50/60Hz | 120mA  
 Total wattage: 9W  
 Material: aluminium/polycarbonate (PC)  
 Dimmable: C

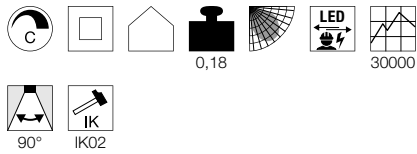

## Dimensional drawing

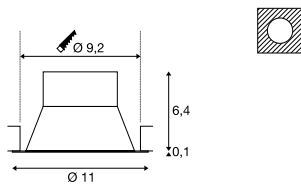

## Tip

Material thickness of mounting surface:  
 20 mm

Variant	Item No.
800/880/850lm   3000/4200/5700K   CRI>80	
□ white	1001264



114440 407

PATTA-F  
EL, round, PHASE



- High IP rating (full protection glass)

Product details

220-240V ~50/60Hz | 500mA  
Total wattage: 11W  
Material: aluminium/glass  
Dimmable: C, L

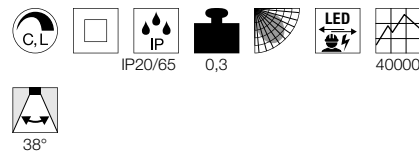

Dimensional drawing

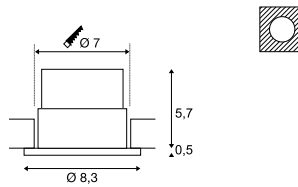

Tip

Material thickness of mounting surface:  
20 mm

PATTA-F  
EL, square, PHASE



- High IP rating (full protection glass)

Product details

220-240V ~50/60Hz | 500mA  
Total wattage: 11W  
Material: aluminium/glass  
Dimmable: C, L

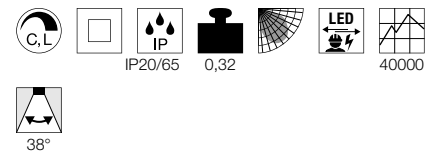

Dimensional drawing

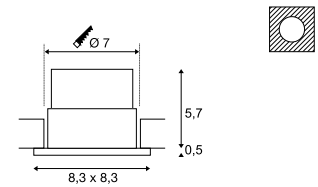

Tip

Material thickness of mounting surface:  
20 mm



114450 407

Variant	Item No.
745lm   3000K   CRI>80	
■ black	114440
860lm   3000K   CRI>80	
□ white	114441

Variant	Item No.
745lm   3000K   CRI>80	
■ black	114450
860lm   3000K   CRI>80	
□ white	114451

PATTA-I  
EL, round, PHASE

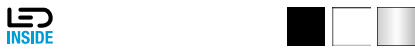

- Premium LED with CRI>90
- Dim to Warm (1800-3000K)
- High IR protection rating

Product details

220-240V ~50/60Hz | 350mA  
Total wattage: 7.3W  
Material: aluminium/glass  
Dimmable: C, L

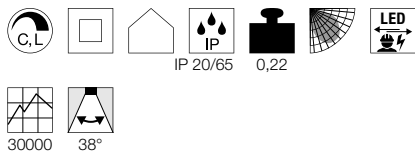

Dimensional drawing

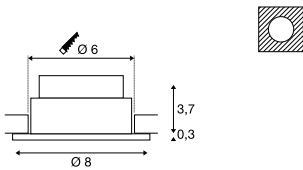

Tip

Products are delivered with spring clips. Leaf springs are included with the product and can be replaced. Material thickness of mounting surface: 20 mm

PATTA-I  
EL, square, PHASE



- Premium LED with CRI>90
- Dim to Warm (1800-3000K)
- High IR protection rating

Product details

220-240V ~50/60Hz | 350mA  
Total wattage: 7.3W  
Material: aluminium/glass  
Dimmable: C, L

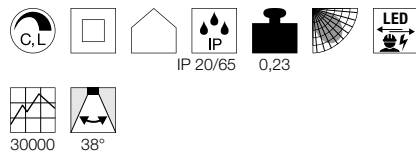

Dimensional drawing

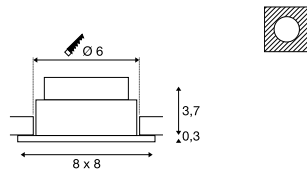

Tip

Products are delivered with spring clips. Leaf springs are included with the product and can be replaced. Material thickness of mounting surface: 20 mm

Variant	Item No.
440lm   1800-3000K   CRI>95	
■ black	1002098
440lm   1800-3000K   CRI>95	
□ white	1002099
440lm   1800-3000K   CRI>95	
■ aluminium	1002100

Variant	Item No.
440lm   1800-3000K   CRI95	
■ black	1002101
440lm   1800-3000K   CRI95	
□ white	1002102
440lm   1800-3000K   CRI95	
■ aluminium	1002103



1002098 408

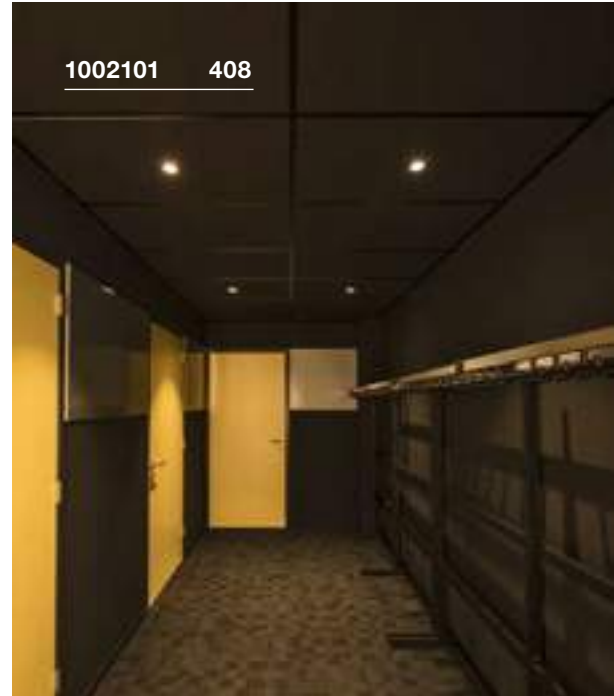

1002101 408

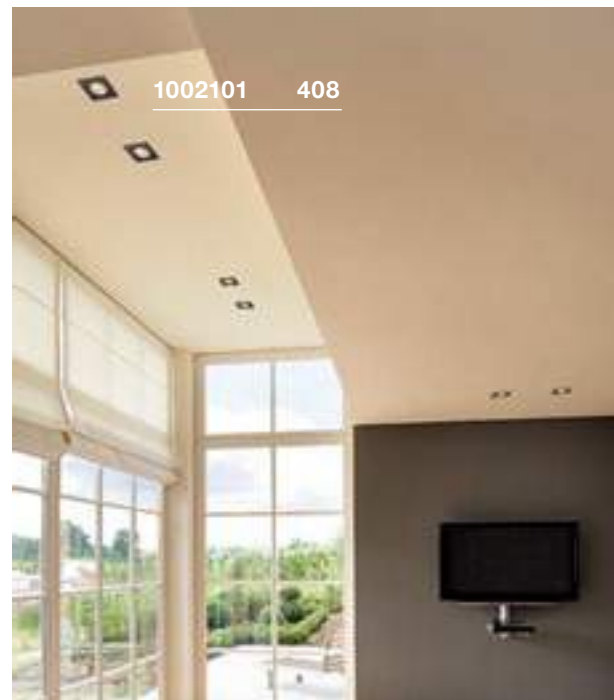

1002101 408





114430 409

**PATTA-I**  
EL, round, PHASE



- High IR protection rating

**Product details**

220-240V ~50/60Hz | 500mA  
Total wattage: 11W  
Material: aluminium/glass  
Dimmable: C, L

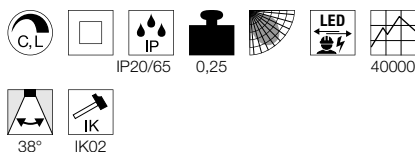

**Dimensional drawing**

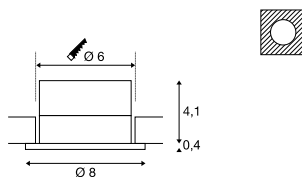

**Tip**

Material thickness of mounting surface:  
25 mm

Variant	Item No.
910lm   3000K   CRI>80	
■ black	114420
910lm   3000K   CRI>80	
□ white	114421
910lm   3000K   CRI>80	
■ aluminium	114426

**PATTA-I**  
EL, square, PHASE

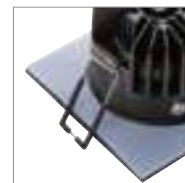

- High IR protection rating

**Product details**

220-240V ~50/60Hz | 500mA  
Total wattage: 11W  
Material: aluminium/glass  
Dimmable: C, L

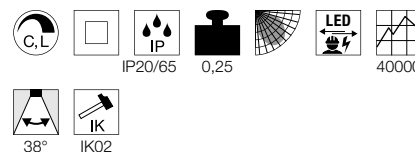

**Dimensional drawing**

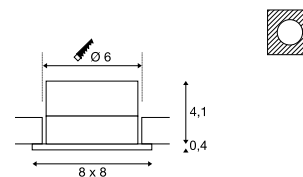

**Tip**

Material thickness of mounting surface:  
25 mm

Variant	Item No.
910lm   3000K   CRI>80	
■ black	114430
910lm   3000K   CRI>80	
□ white	114431
910lm   3000K   CRI>80	
■ aluminium	114436

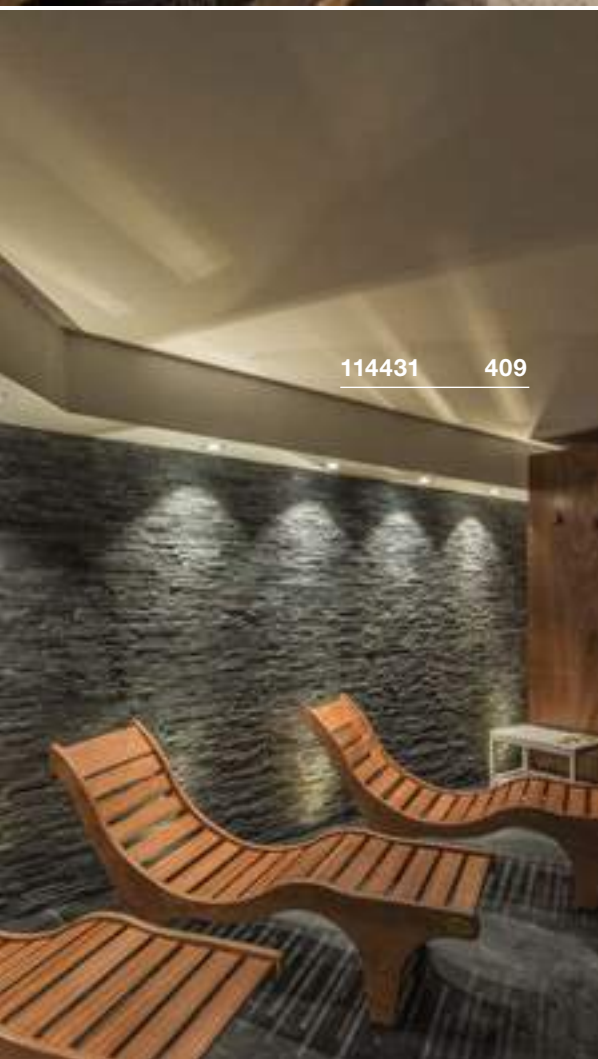

114431 409

117311 411



117331 411

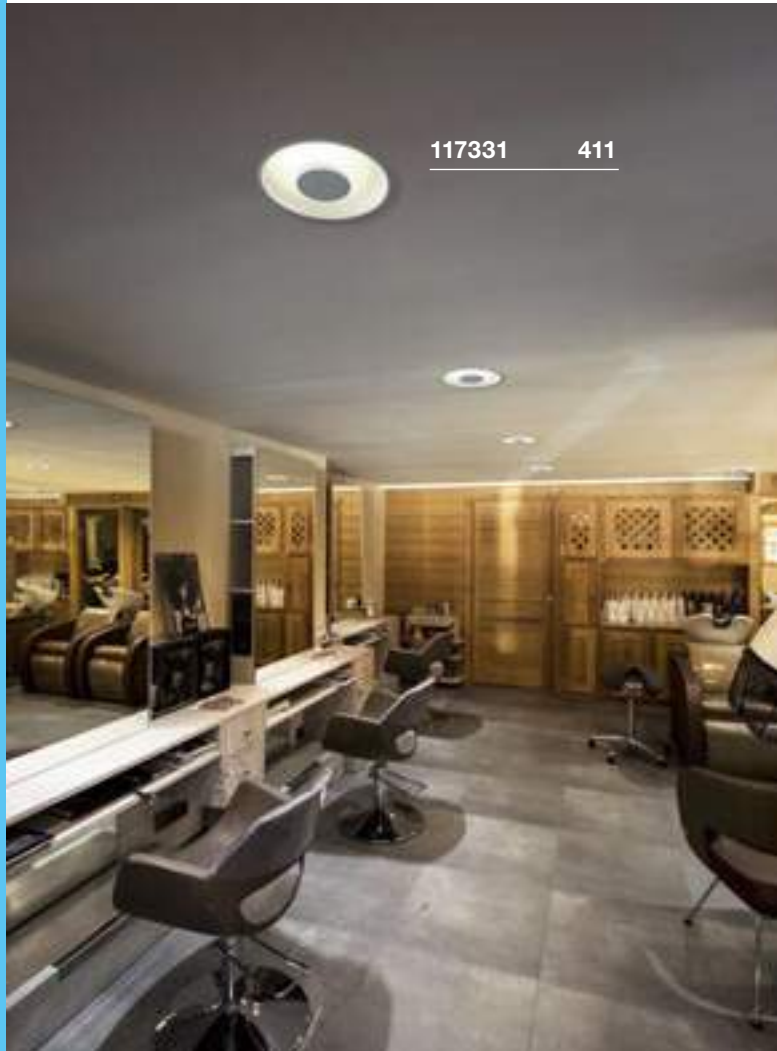

117331 411





117331 411

OCCULDAS 23  
EL, indirect, PHASE



- Indirect, glare-free lighting
- Especially flat frames and low installation depth

Product details

200-240V ~50/60Hz | 700mA  
Total wattage: 26W  
Material: aluminium/steel  
Dimmable: C, L

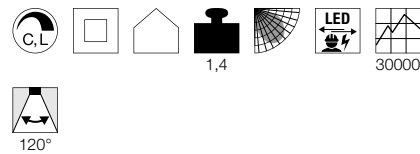

Dimensional drawing

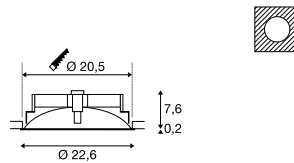

Tip

Material thickness of mounting surface:  
max. 10-30 mm

OCCULDAS 14  
EL, Indirect, PHASE



- Indirect, glare-free lighting
- Especially flat frames and low installation depth

Product details

220-240V ~50/60Hz | 350mA  
Total wattage: 15W  
Material: aluminium/steel  
Dimmable: C, L

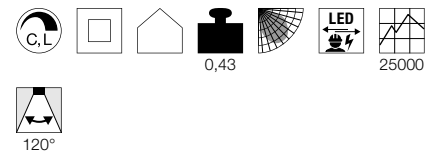

Dimensional drawing

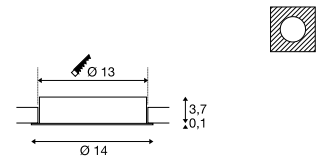

Tip

Material thickness of mounting surface:  
max. 1-20 mm

Variant	Item No.
1500lm   3000K   CRI>80 □ matt white	117311

Variant	Item No.
810lm   3000K   CRI>80 □ matt white	117331



113160    413

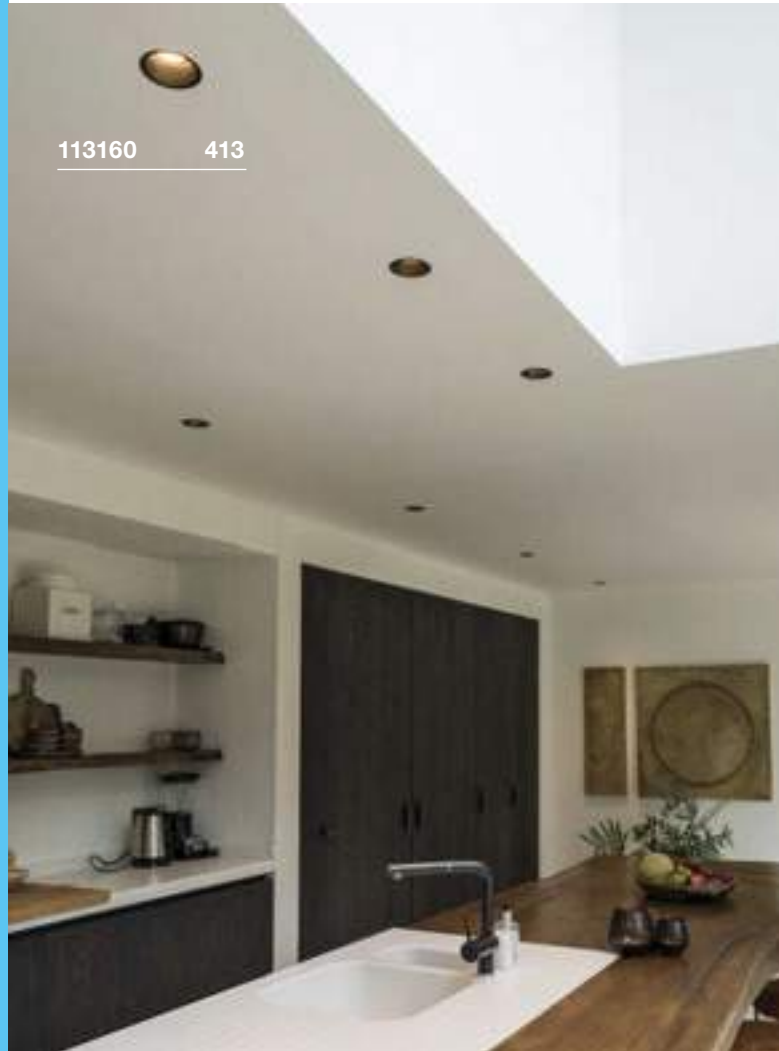

113160    413



113151    413

**HORN-O**  
EL, QPAR51

SOCKET  
INSIDE

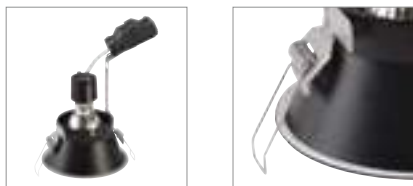

- Narrow installation collar
- Protective glass for IP 21-use

**Product details**

230V -50Hz  
Material: steel

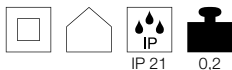

**Dimensional drawing**

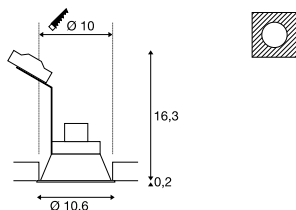

**Tip**

Material thickness of mounting surface:  
max. 25 mm

**Recommended lamp**

LED GU10 5.5W 38°  
2700K 400lm  
6kWh/1000h  
**Item No. 1001030**



LED GU10 6W 36°  
2700K 460lm  
6kWh/1000h  
**Item No. 1005076**



**Lamp details**

max. 50W QPAR51

Variant	Item No.
GU10   QPAR51	
■ black	<b>113160</b>
GU10   QPAR51	
□ white	<b>113161</b>

**HORN-T**  
EL, QPAR51

SOCKET  
INSIDE



- Narrow installation collar

**Product details**

220-240V ~50/60Hz  
Material: steel



**Dimensional drawing**

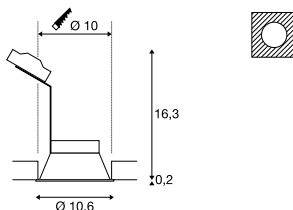

**Tip**

Material thickness of mounting surface:  
max. 25 mm

**Recommended lamp**

LED GU10 3,7W 36°  
2700K 260lm  
4kWh/1000h  
**Item No. 560122**



LED GU10 6W 36°  
3000K 460lm  
6kWh/1000h  
**Item No. 1005079**



**Lamp details**

max. 50W QPAR51

Variant	Item No.
GU10   QPAR51	
■ black	<b>113140</b>
GU10   QPAR51	
□ white	<b>113141</b>

**HORN-A**  
EL, QPAR51

SOCKET  
INSIDE



- Asymmetrical light emission
- Protective glass for IP 21-use

**Product details**

230V -50Hz  
Material: steel



**Dimensional drawing**

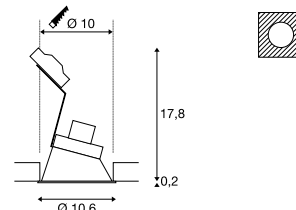

**Tip**

Material thickness of mounting surface:  
25 mm

**Recommended lamp**

LED GU10 4W 36°  
3000K 300lm  
4kWh/1000h  
**Item No. 1004973**



LED GU10 4W 36°  
4000K 300lm  
4kWh/1000h  
**Item No. 1004974**



**Lamp details**

max. 50W QPAR51

Variant	Item No.
GU10   QPAR51	
■ black	<b>113150</b>
GU10   QPAR51	
□ white	<b>113151</b>

HORN-T  
EL, QPAR111

SECRET  
INSIDE



- Narrow installation collar

Product details

230V -50Hz  
Material: steel



0,5

Dimensional drawing

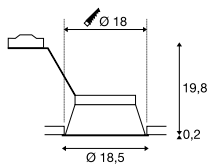

Tip

Material thickness of mounting surface:  
max. 30 mm

Recommended lamp

LED GU10 13W 55°  
2700K 840lm  
13kWh/1000h  
Item No. 1003094



LED GU10 6.5W 38°  
2700K 390lm  
7kWh/1000h  
Item No. 551882



Lamp details

max. 75W QPAR111

Variant	Item No.
GU10   QPAR111	
■ black	113170
GU10   QPAR111	
□ white	113171

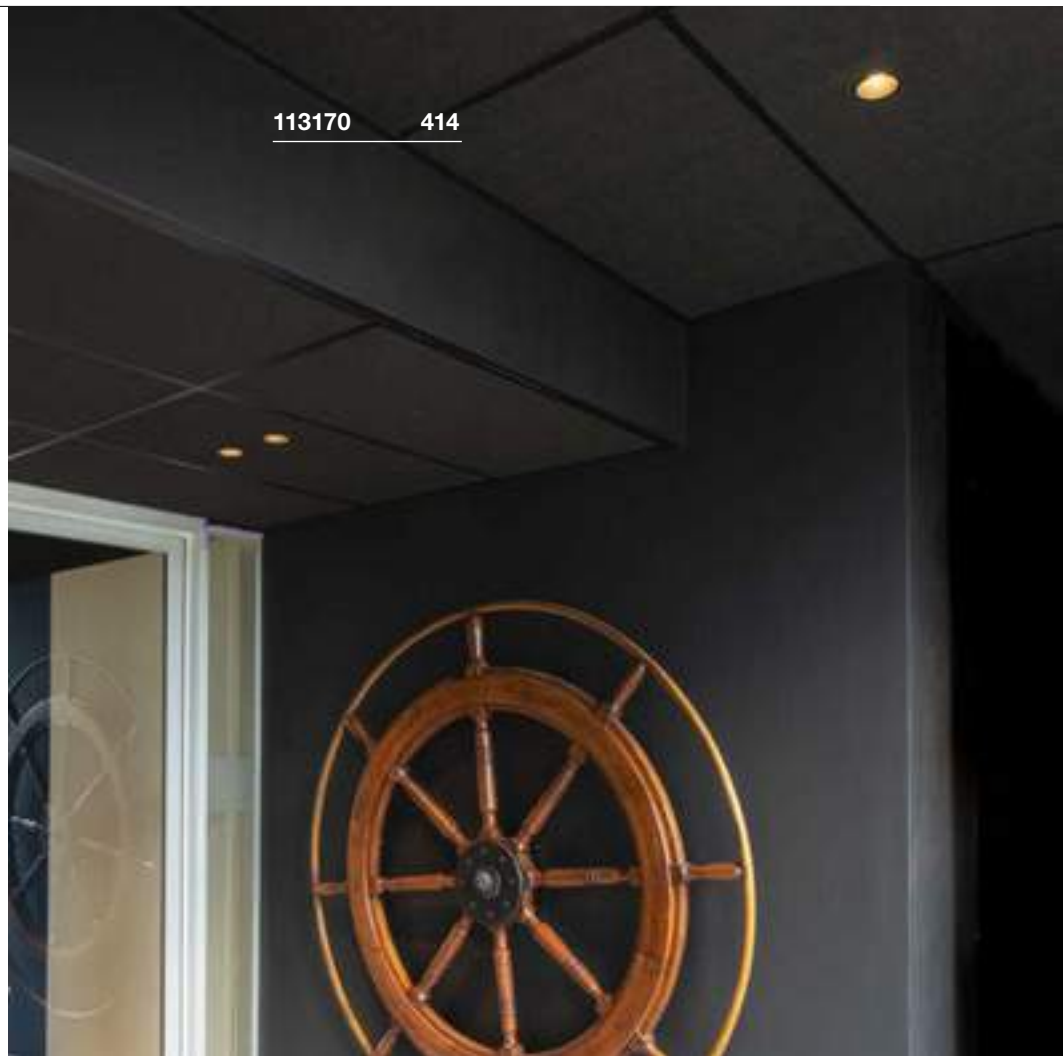

113170

414

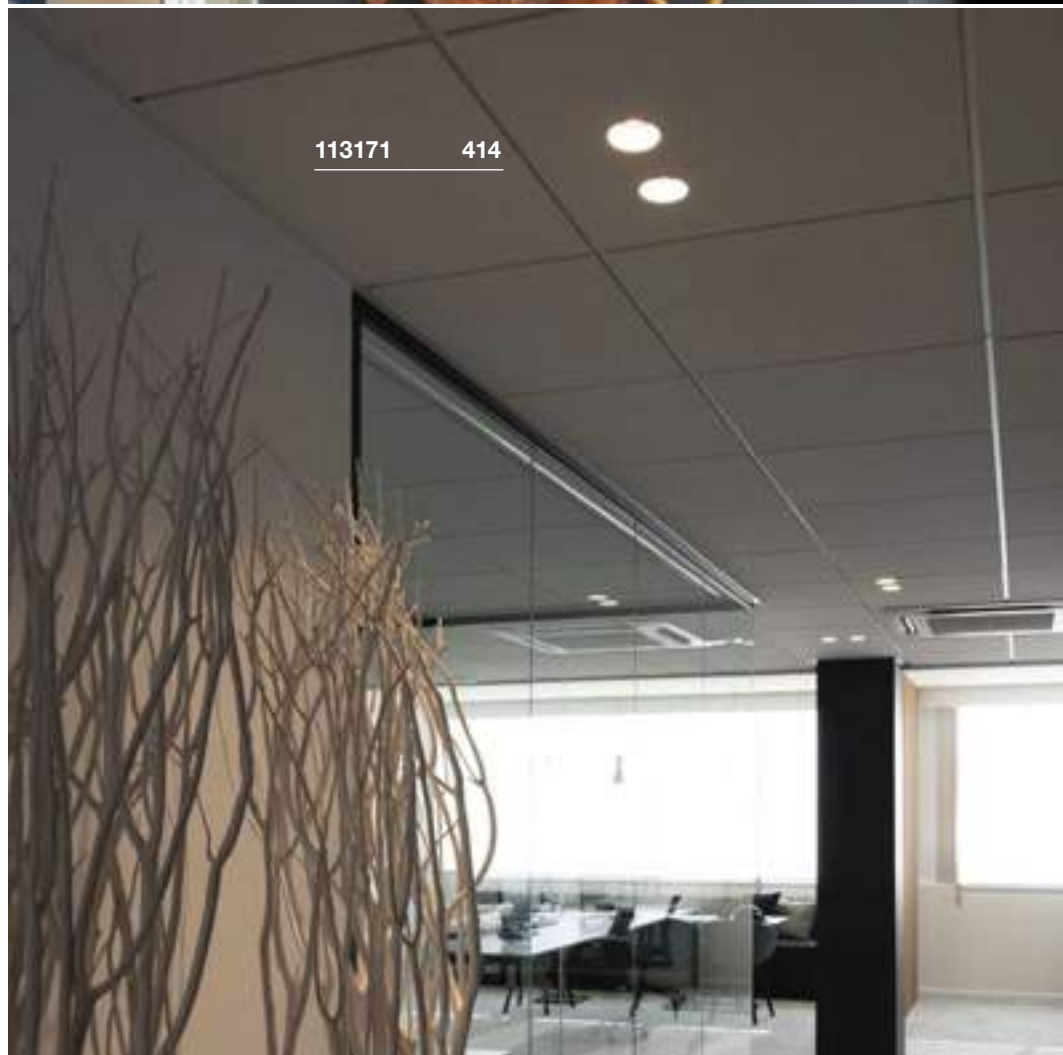

113171

414



113110 415



113110 415



112910 415

**HORN**  
EL, QPAR51

SOCKET  
INSIDE



- Narrow installation collar

**Product details**

230V -50Hz  
Material: steel



0,13

**Dimensional drawing**

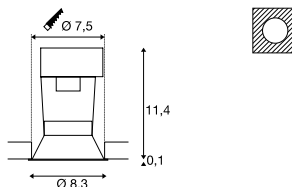

**Tip**

Material thickness of mounting surface:  
max. 45 mm

**Recommended lamp**

LED GU10 6W 36°  
3000K 460lm  
6kWh/1000h  
Item No. 1005080



LED GU10 4W 36°  
4000K 300lm  
4kWh/1000h  
Item No. 1004974



**Lamp details**

max. 50W QPAR51

Variant	Item No.
GU10   QPAR51	
■ black	112910
GU10   QPAR51	
□ white	112911

**HORN**  
EL, QPAR51

SOCKET  
INSIDE

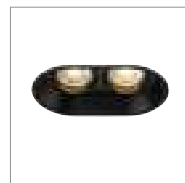

- Narrow installation collar

**Product details**

230V -50Hz  
Material: aluminium/steel



0,35 350° 60°

**Dimensional drawing**

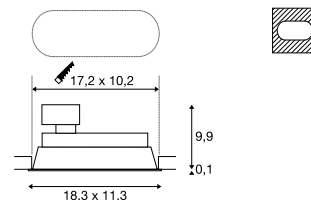

**Tip**

Material thickness of mounting surface:  
max. 45 mm

**Recommended lamp**

LED GU10 5.5W 38°  
2700K 400lm  
6kWh/1000h  
Item No. 1001030



LED 6W 36°  
2700K 460lm  
6kWh/1000h  
Item No. 1005075



**Lamp details**

2x max. 50W QPAR51

Variant	Item No.
GU10   QPAR51	
■ black	113110
GU10   QPAR51	
□ white	113111

HORN MINI  
EL



• Premium LED with CRI>90

Product details

350mA | 1.2W  
Material: aluminium/polycarbonate (PC)

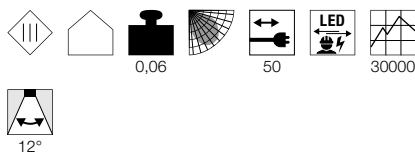

Dimensional drawing

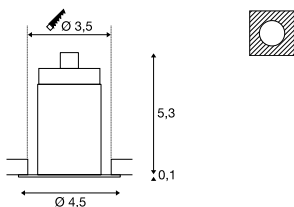

Tip

Driver not included  
AMP plug included  
Different light colour with golden reflector

Accessory recommendation

- LED driver 350mA | 15W  
Item No. 464031
- Connector strip 3 outlets  
Item No. 111850

Variant	Item No.
70lm   3000K   CRI>90 <input type="checkbox"/> white	1000914
70lm   3000K   CRI>90 <input checked="" type="checkbox"/> black	1000915
70lm   3000K   CRI>90 <input checked="" type="checkbox"/> black/gold	1000917

HORN MEDI  
EL



Product details

350mA | 5W  
Material: aluminium/polycarbonate (PC)

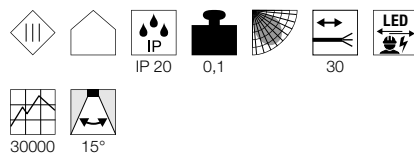

Dimensional drawing

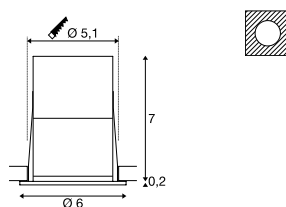

Tip

Different light colour with golden reflector  
Open cable end

Accessory recommendation

- LED driver 320mA | 10W  
Item No. 464140

Variant	Item No.
350lm   3000K   CRI>80 <input type="checkbox"/> white	1001924
230lm   3000K   CRI>80 <input checked="" type="checkbox"/> black	1001925
275lm   3000K   CRI>80 <input checked="" type="checkbox"/> black/gold	1001927

HORN MAGNA  
EL

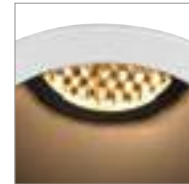
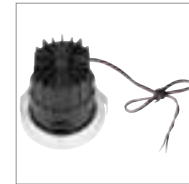

Product details

500mA | 7.7W  
Material: aluminium/polycarbonate (PC)

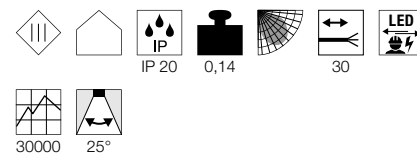

Dimensional drawing

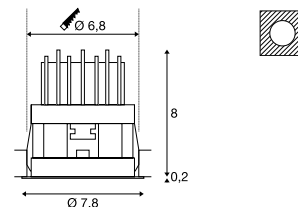

Tip

Driver not included  
Different light colour with golden reflector  
Open cable end

Accessory recommendation

- Glare protection  
Item No. 1002596
- LED driver 500mA | 9W  
Item No. 464091

Variant	Item No.
470lm   3000K   CRI>80 <input type="checkbox"/> white	1002591
415lm   3000K   CRI>80 <input checked="" type="checkbox"/> black	1002592
400lm   3000K   CRI>80 <input checked="" type="checkbox"/> black/gold	1002594





1001924 416

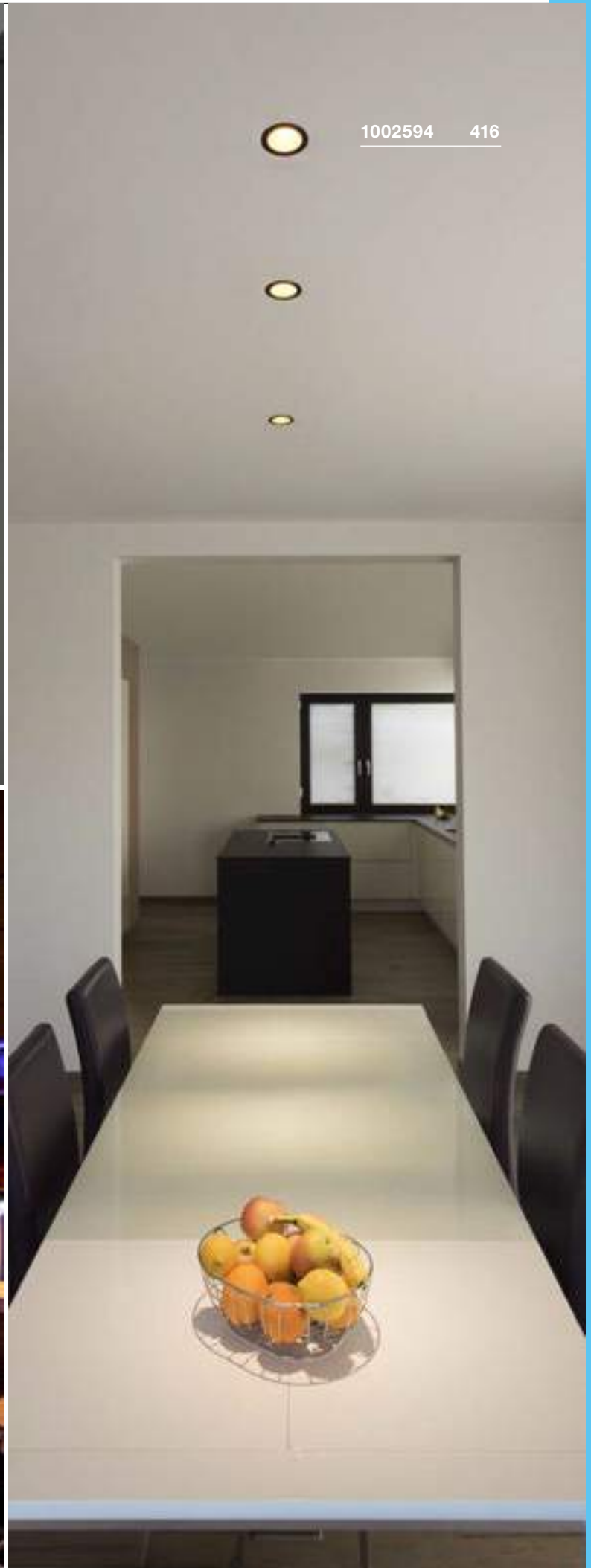









1002594 416



1001925 416







# NEW TRIA LIGHTING SERIES.

## RECESSED LIGHTS.

Conventional NEW TRIA	NEW TRIA 68	NEW TRIA 78 SL	NEW TRIA 78	NEW TRIA 78	
Example					
Shape					
Lamp	<b>SOCKET INSIDE</b> QPAR51	<b>SOCKET INSIDE</b> QPAR51	<b>SOCKET INSIDE</b> QPAR51	<b>SOCKET INSIDE</b> QPAR51	
Lumen	-	-	-	-	
Colour	-	-	-	-	
Dimmable	-	-	-	-	
Variant	Spring clips/leaf springs	Spring clips	Leaf springs	Spring clips	
IP	-	-	-	-	

LED NEW TRIA	NEW TRIA 45	NEW TRIA 68	NEW TRIA 68	NEW TRIA 68	
Example					
Shape					
Lamp	<b>LED INSIDE</b>	<b>LED INSIDE</b>	<b>LED INSIDE</b>	<b>LED INSIDE</b> 	
Lumen	143lm	300lm	800lm-890lm	440lm	
Colour	3000K	2700K/3000K	2700K/3000K	1800K-3000K	
Dimmable	-	-	C, L	C, L	
Variant	Spring clips	Spring clips	Spring clips	Spring clips/leaf springs	
IP	IP 44	-	-	-	



	NEW TRIA 155	NEW TRIA 150	NEW TRIA 300
			
			
	<b>SOCKET</b> <b>INSIDE</b> QPAR51	<b>SOCKET</b> <b>INSIDE</b> QPAR111	<b>SOCKET</b> <b>INSIDE</b> QPAR111
	-	-	-
	-	-	-
	-	-	-
	Spring clips	Leaf springs	Spring clips
	-	-	-

	NEW TRIA 77	NEW TRIA 155	NEW TRIA 110	NEW TRIA 150
				
				
	<b>LED</b> <b>INSIDE</b>	<b>LED</b> <b>INSIDE</b>	<b>LED</b> <b>INSIDE</b>	<b>LED</b> <b>INSIDE</b>
	645lm-700lm	1160lm-1250lm	1010lm-1120lm	2210lm-2500lm
	2700K/3000K	2700K/3000K	2700K/3000K	2700K/3000K
	-	-	C, L	1-10V
	Spring clips	Spring clips	Spring clips	Spring clips
	-	-	-	-

**NEW TRIA 68**  
Single, round, CS/LS, QPAR51

SOCKET INSIDE 



**Product details**

230V -50Hz  
Material: aluminium



0,13 30°

**Dimensional drawing**

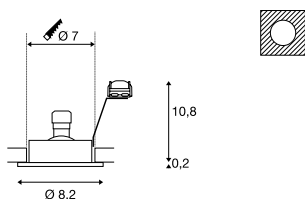

**Tip**

Products are delivered with spring clips. Leaf springs are included with the product and can be replaced. Material thickness of mounting surface: 20 mm

**Recommended lamp**

LED GU10 5.5W 38°  
2700K 400lm  
6kWh/1000h  
Item No. 1001030



LED GU10 3,7W 36°  
2700K 260lm  
4kWh/1000h  
Item No. 560122



**Lamp details**

max. 50W QPAR51

Variant	Item No.
GU10   QPAR51	
■ black	1001980
□ white	1001981
□ aluminium	1001982

**NEW TRIA 68**  
Single, square, CS/LS, QPAR51

SOCKET INSIDE 



**Product details**

230V -50Hz  
Material: aluminium



0,14 30°

**Dimensional drawing**

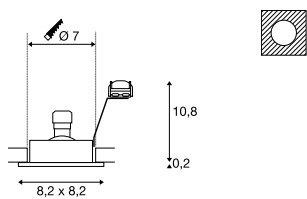

**Tip**

Products are delivered with spring clips. Leaf springs are included with the product and can be replaced. Material thickness of mounting surface: 20 mm

**Recommended lamp**

LED 6W 36°  
2700K 460lm  
6kWh/1000h  
Item No. 1005075



LED GU10 4W 36°  
2700K 300lm  
4kWh/1000h  
Item No. 1004972



**Lamp details**

max. 50W QPAR51

Variant	Item No.
GU10   QPAR51	
■ black	1001994
□ white	1001995
□ aluminium	1001996

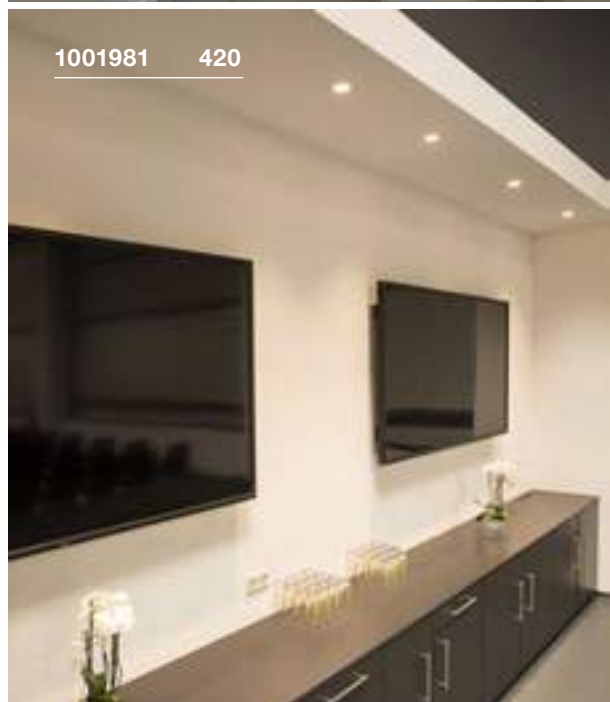
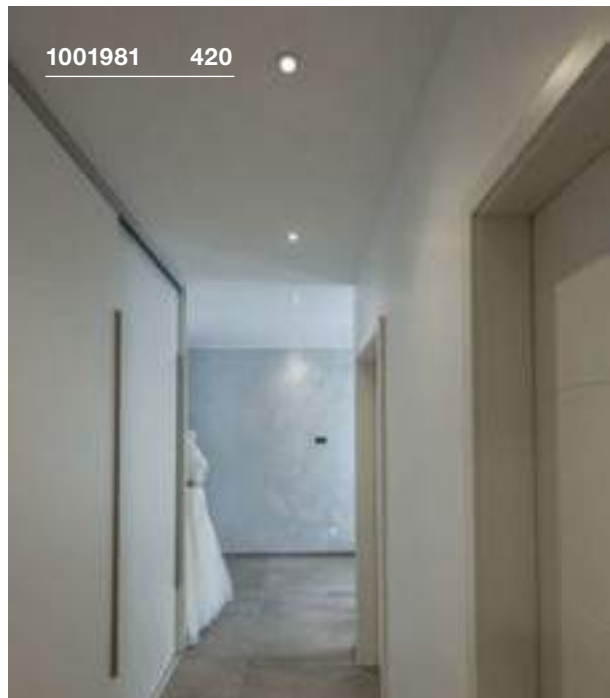
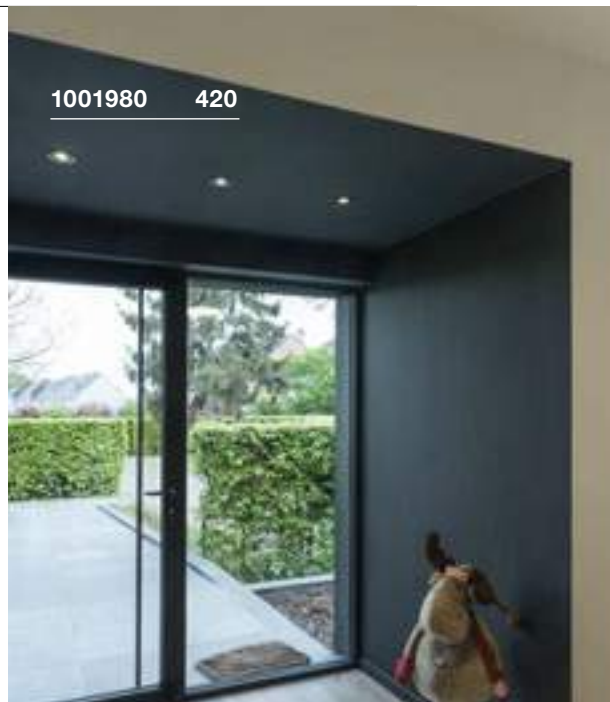



113456 421

**NEW TRIA 78 XL**  
Single, round, CS, QPAR51

SOCKET INSIDE



• Wide edge

**Product details**

230V -50Hz  
Material: aluminium



0,19 360° 30°

**Dimensional drawing**

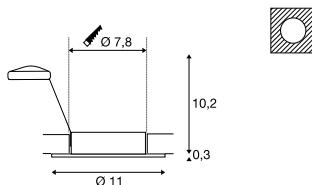

**Tip**

Material thickness of mounting surface:  
18 mm

**Recommended lamp**

LED 6W 36°  
2700K 460lm  
6kWh/1000h  
Item No. 1005077



LED 6W 36°  
2700K 460lm  
6kWh/1000h  
Item No. 1005075



**Lamp details**

max. 50W QPAR51

Variant	Item No.
GU10   QPAR51	
■ black	113440
□ white	113441
■ aluminium	113446



113440 421

**NEW TRIA 78 XL**  
Single, square, CS, QPAR51

SOCKET INSIDE



• Wide edge

**Product details**

230V -50Hz  
Material: aluminium



0,21 360° 30°

**Dimensional drawing**

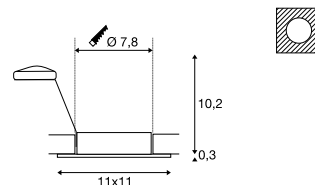

**Tip**

Material thickness of mounting surface:  
18 mm

**Recommended lamp**

LED GU10 6W 36°  
3000K 460lm  
6kWh/1000h  
Item No. 1005078



LED GU10 4W 36°  
3000K 300lm  
4kWh/1000h  
Item No. 1004973



**Lamp details**

max. 50W QPAR51

Variant	Item No.
GU10   QPAR51	
■ black	113450
□ white	113451
■ aluminium	113456

**NEW TRIA 78**  
Single, round, LS, QPAR51



**NEW TRIA 78**  
Single, square, LS, QPAR51

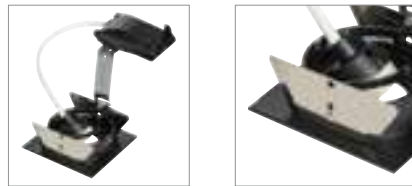

**Product details**

220-240V ~50/60Hz  
Material: aluminium

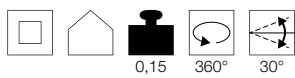

**Dimensional drawing**

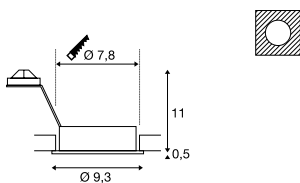

**Tip**

Leaf springs  
Material thickness of mounting surface:  
max. 20 mm

**Recommended lamp**

LED GU10 5.5W 38°  
2700K 400lm  
6kWh/1000h  
**Item No. 1001030**



LED GU10 3,7W 36°  
2700K 260lm  
4kWh/1000h  
**Item No. 560122**



**Lamp details**

max. 50W QPAR51

Variant	Item No.
GU10   QPAR51	
■ black	<b>111710</b>
□ white	<b>111711</b>
■ aluminium	<b>111716</b>

**Product details**

220-240V ~50/60Hz  
Material: aluminium

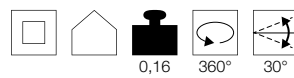

**Dimensional drawing**

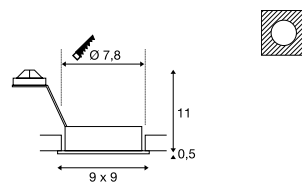

**Tip**

Leaf springs  
Material thickness of mounting surface:  
max. 20 mm

**Recommended lamp**

LED 6W 36°  
2700K 460lm  
6kWh/1000h  
**Item No. 1005075**



LED GU10 4W 36°  
2700K 300lm  
4kWh/1000h  
**Item No. 1004972**



**Lamp details**

max. 50W QPAR51

Variant	Item No.
GU10   QPAR51	
■ black	<b>111720</b>
□ white	<b>111721</b>
■ aluminium	<b>111726</b>

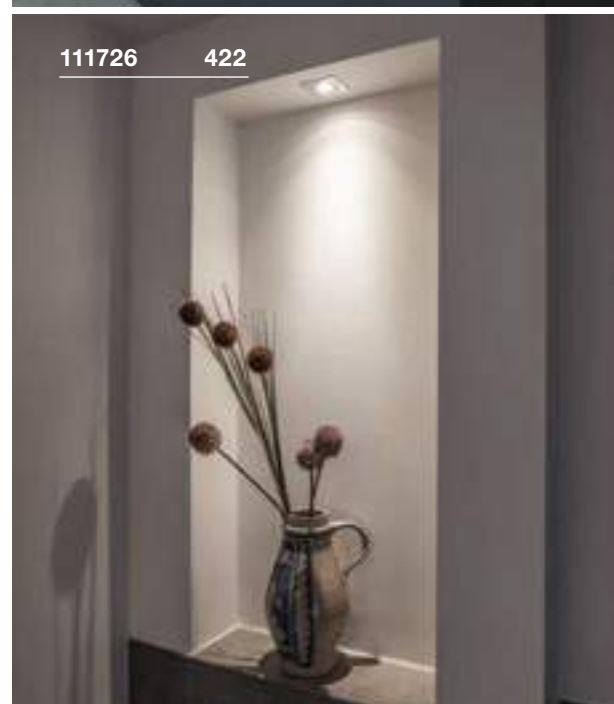
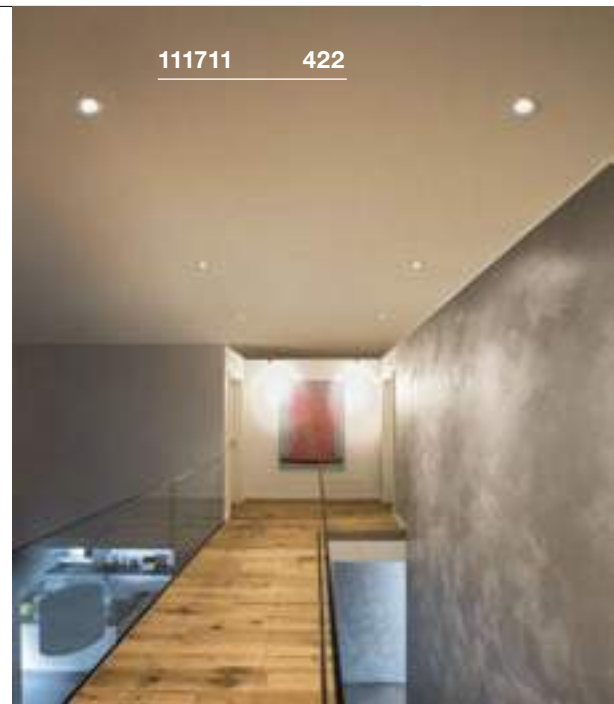



113510 423



113510 423



113511 423

**NEW TRIA 78**  
Single, round, CS, QPAR51

SOCKET  
INSIDE



**Product details**

220-240V ~50/60Hz  
Material: aluminium



**Dimensional drawing**

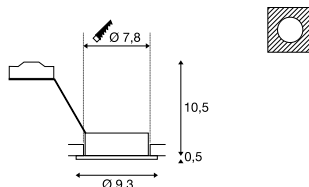

**Tip**

Spring clips  
Material thickness of mounting surface:  
max. 18 mm

**Recommended lamp**

LED 6W 36°  
2700K 460lm  
6kWh/1000h  
Item No. 1005077



LED 6W 36°  
2700K 460lm  
6kWh/1000h  
Item No. 1005075



**Lamp details**

max. 50W QPAR51

Variant	Item No.
GU10   QPAR51	
■ black	113490
□ white	113510
□ aluminium	111360

**NEW TRIA 78**  
Single, square, CS, QPAR51

SOCKET  
INSIDE



**Product details**

220-240V ~50/60Hz  
Material: aluminium



**Dimensional drawing**

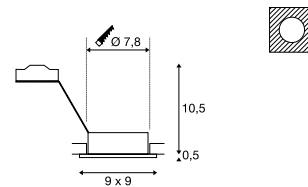

**Tip**

Spring clips  
Material thickness of mounting surface:  
max. 18 mm

**Recommended lamp**

LED GU10 6W 36°  
3000K 460lm  
6kWh/1000h  
Item No. 1005078



LED GU10 4W 36°  
3000K 300lm  
4kWh/1000h  
Item No. 1004973



**Lamp details**

max. 50W QPAR51

Variant	Item No.
GU10   QPAR51	
■ black	113491
□ white	113511
□ aluminium	111361

**NEW TRIA 155**  
Double, CS, QPAR51

SOCKET  
INSIDE



**Product details**

220-240V ~50/60Hz  
Material: aluminium



**Dimensional drawing**

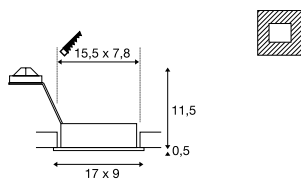

**Tip**

Spring clips  
Material thickness of mounting surface:  
max. 30 mm

**Recommended lamp**

LED GU10 5.5W 38°  
2700K 400lm  
6kWh/1000h  
Item No. 1001030



LED GU10 6W 36°  
2700K 460lm  
6kWh/1000h  
Item No. 1005076



**Lamp details**

2x max. 50W QPAR51

Variant	Item No.
GU10   QPAR51	
■ black	113492
GU10   QPAR51	
□ white	113512
GU10   QPAR51	
▒ aluminium	111362

113492 424

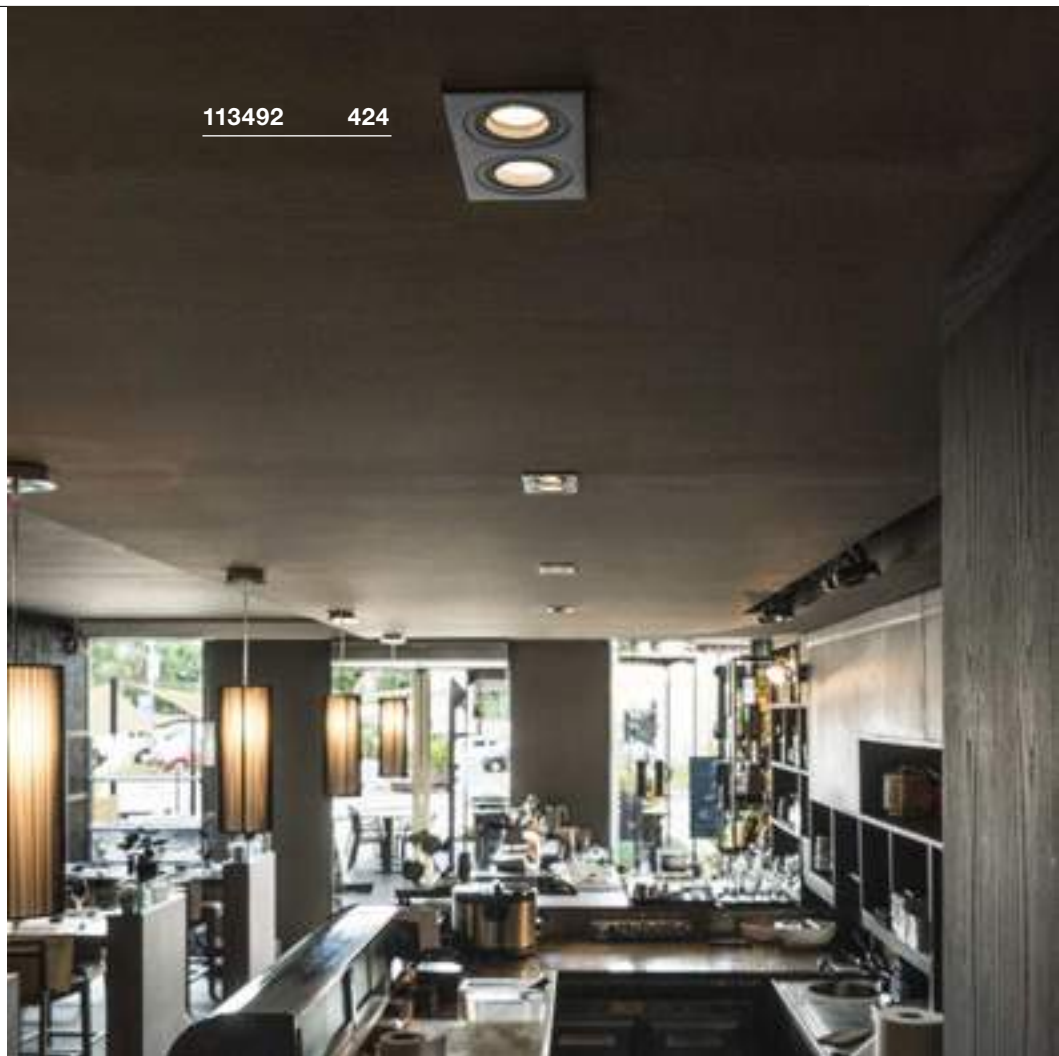

111381 425

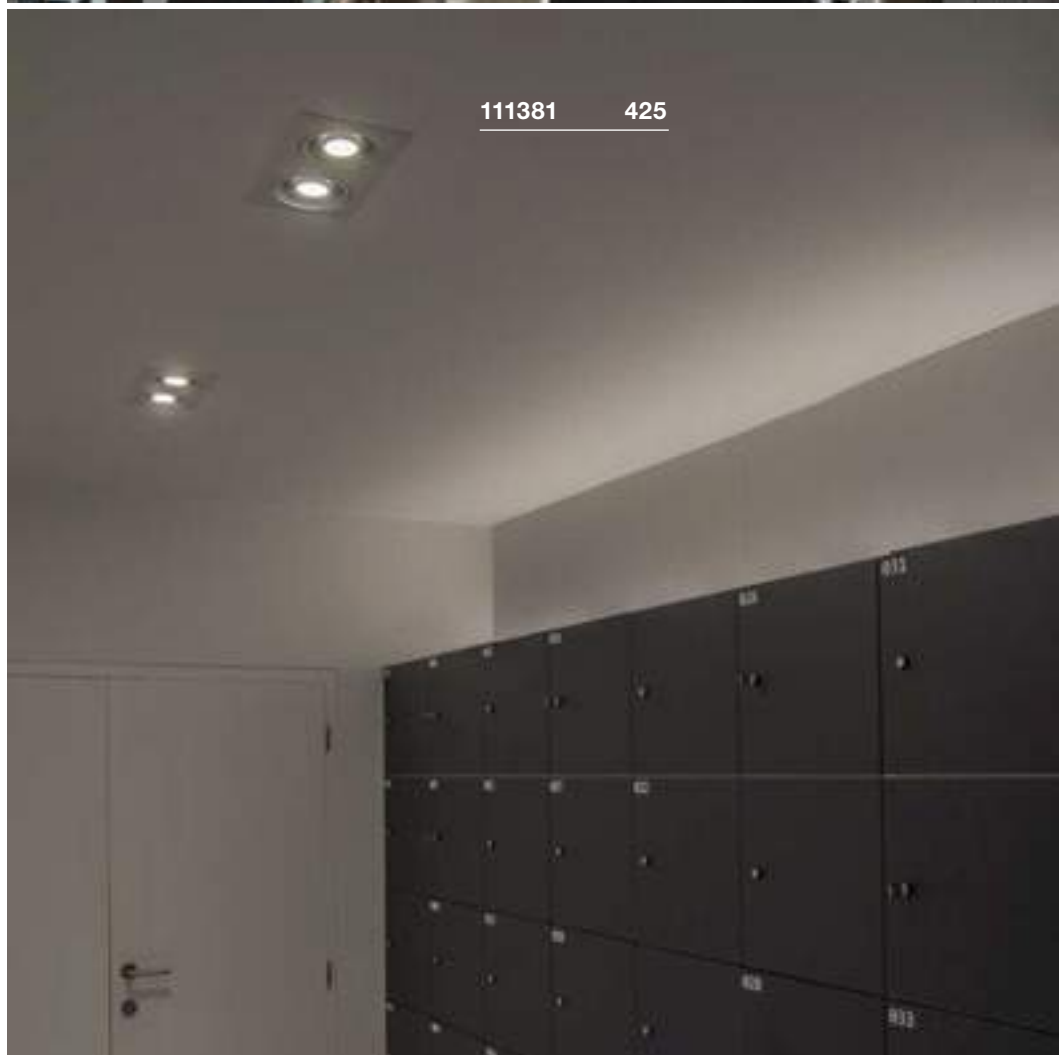



**NEW TRIA 150**  
Single, round, LS, QPAR111



**Product details**

230V -50Hz  
Material: aluminium



**Dimensional drawing**

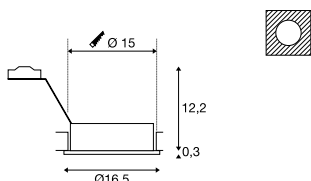

**Tip**

Leaf springs  
Material thickness of mounting surface:  
max. 30 mm

**Recommended lamp**

LED GU10 13W 55°  
2700K 840lm  
13kWh/1000h  
Item No. 1003094



LED GU10 13W 30°  
4000K 1100lm  
13kWh/1000h  
Item No. 1003087



**Lamp details**

max. 75W QPAR111

Variant	Item No.
GU10   QPAR111	
■ black	113550
GU10   QPAR111	
□ white	113540
GU10   QPAR111	
■ aluminium	111380

**NEW TRIA 150**  
Single, square, LS, QPAR111



**Product details**

230V -50Hz  
Material: aluminium



**Dimensional drawing**

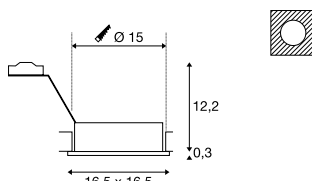

**Tip**

Leaf springs  
Material thickness of mounting surface:  
max. 30 mm

**Recommended lamp**

LED GU10 13W 30°  
2700K 1100lm  
13kWh/1000h  
Item No. 1001242



LED GU10 6.5W 38°  
2700K 390lm  
7kWh/1000h  
Item No. 551882



**Lamp details**

max. 75W QPAR111

Variant	Item No.
GU10   QPAR111	
■ black	113830
GU10   QPAR111	
□ white	113541
GU10   QPAR111	
■ aluminium	111381

**NEW TRIA 300**  
Double, CS, QPAR111



**Product details**

230V -50Hz  
Material: aluminium



**Dimensional drawing**

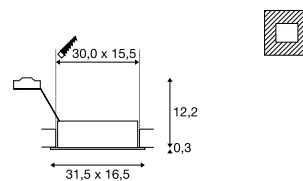

**Tip**

Spring clips  
Material thickness of mounting surface:  
max. 30 mm

**Recommended lamp**

LED GU10 13W 55°  
2700K 840lm  
13kWh/1000h  
Item No. 1003094



LED GU10 9.5W 40°  
2200-6700K 800lm  
10kWh/1000h  
Item No. 1001923



**Lamp details**

2x max. 75W QPAR111

Variant	Item No.
GU10   QPAR111	
■ black	113840
GU10   QPAR111	
□ white	113841
GU10   QPAR111	
■ aluminium	111382

**NEW TRIA 45**  
Single, round, CS



**Product details**

220-240V ~50/60Hz | 700mA  
Total wattage: 4.4W  
Material: aluminium

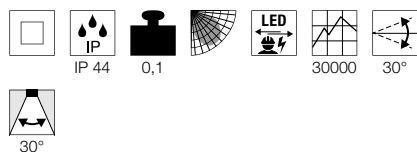

**Dimensional drawing**

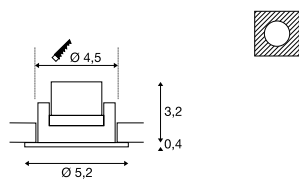

**Tip**

Spring clips  
Material thickness of mounting surface:  
max. 20 mm

**NEW TRIA 45**  
Single, square, CS



**Product details**

220-240V ~50/60Hz | 700mA  
Total wattage: 4.4W  
Material: aluminium



**Dimensional drawing**

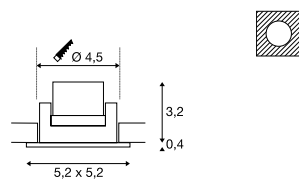

**Tip**

Spring clips  
Material thickness of mounting surface:  
max. 20 mm

Variant	Item No.
143lm   3000K   CRI>80 ■ black	113970
143lm   3000K   CRI>80 □ white	113971
143lm   3000K   CRI>80 ■ aluminium	113976

Variant	Item No.
143lm   3000K   CRI>80 ■ black	114400
143lm   3000K   CRI>80 □ white	114401
143lm   3000K   CRI>80 ■ aluminium	114406

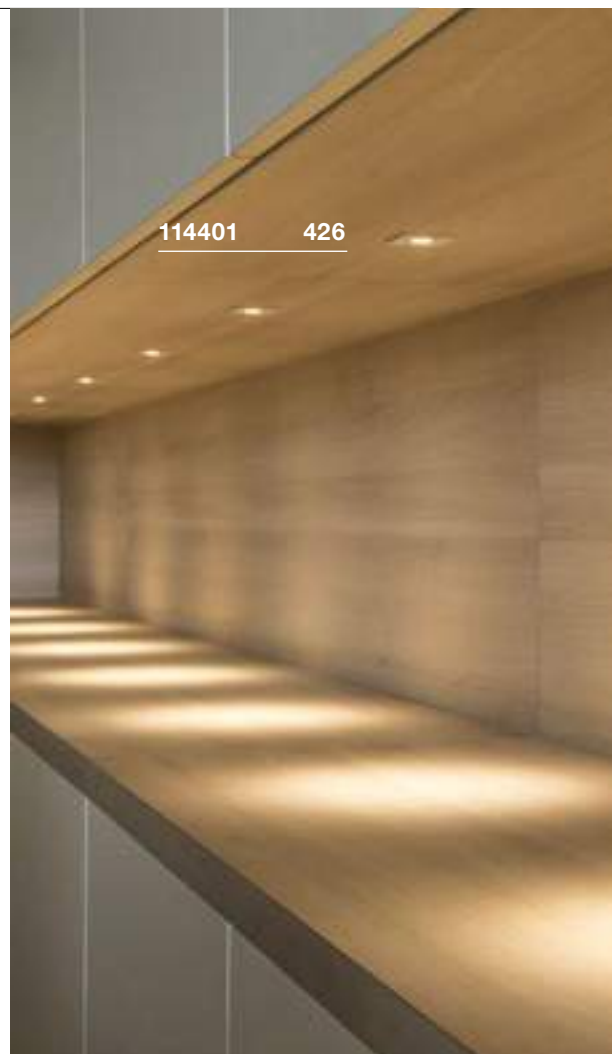

114401 426



113951 427



113956 427



1003058 427

**NEW TRIA 68**  
Single, round, CS



- Premium LED
- Installation depth <40 mm
- Convenient ceiling cut-out for standard drill bit

**Product details**

220-240V ~50/60Hz | 350mA  
Total wattage: 5.3W  
Material: aluminium

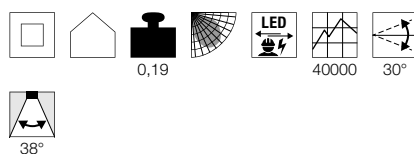

**Dimensional drawing**

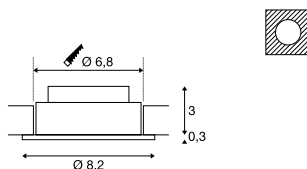

**Tip**

Spring clips  
Material thickness of mounting surface:  
20 mm

Variant	Item No.
300lm   2700K   CRI80	
■ matt black	<b>1003058</b>
300lm   2700K   CRI80	
□ matt white	<b>1003059</b>
300lm   2700K   CRI80	
■ brushed aluminium	<b>1003060</b>
300lm   3000K   CRI80	
■ matt black	<b>1003057</b>
300lm   3000K   CRI80	
□ matt white	<b>113951</b>
300lm   3000K   CRI80	
■ brushed aluminium	<b>113956</b>

**NEW TRIA 68**  
Single, square, CS



- Premium LED
- Installation depth <40 mm
- Convenient ceiling cut-out for standard drill bit

**Product details**

220-240V ~50/60Hz | 350mA  
Total wattage: 5.3W  
Material: aluminium

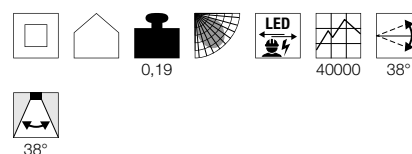

**Dimensional drawing**

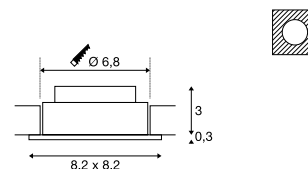

**Tip**

Spring clips  
Material thickness of mounting surface:  
20 mm

Variant	Item No.
300lm   2700K   CRI80	
■ matt black	<b>1003062</b>
300lm   2700K   CRI80	
□ matt white	<b>1003063</b>
300lm   2700K   CRI80	
■ brushed aluminium	<b>1003064</b>
300lm   3000K   CRI80	
■ matt black	<b>1003061</b>
300lm   3000K   CRI80	
□ matt white	<b>113961</b>
300lm   3000K   CRI80	
■ brushed aluminium	<b>113966</b>

**NEW TRIA 68**  
EL, single, round, CS, PHASE



**NEW TRIA 68**  
Single, square, CS, PHASE



**Product details**

220-240V ~50/60Hz | 500mA  
Total wattage: 12W  
Material: aluminium  
Dimmable: C, L

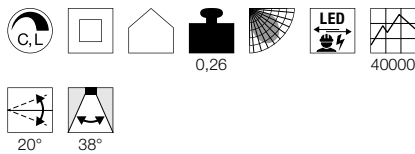

**Dimensional drawing**

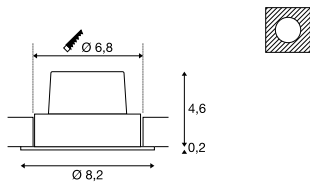

**Tip**

Spring clips  
Material thickness of mounting surface:  
20 mm

**Product details**

220-240V ~50/60Hz | 500mA  
Total wattage: 11W  
Material: aluminium  
Dimmable: C, L

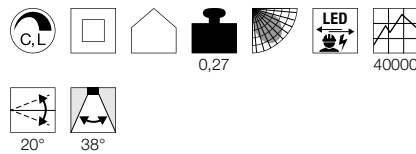

**Dimensional drawing**

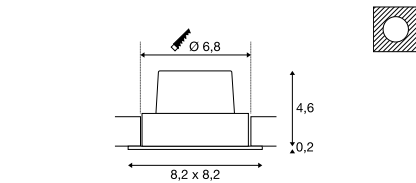

**Tip**

Spring clips  
Material thickness of mounting surface:  
20 mm

Variant	Item No.
800lm   2700K   CRI>80	
■ black	<b>1003065</b>
800lm   2700K   CRI>80	
□ white	<b>1003066</b>
800lm   2700K   CRI>80	
▒ aluminium	<b>1003067</b>
890lm   3000K   CRI>80	
■ black	<b>114380</b>
890lm   3000K   CRI>80	
□ white	<b>114381</b>
890lm   3000K   CRI>80	
▒ brushed aluminium	<b>114386</b>

Variant	Item No.
800lm   2700K   CRI>80	
■ black	<b>1003068</b>
800lm   2700K   CRI>80	
□ white	<b>1003069</b>
800lm   2700K   CRI>80	
▒ aluminium	<b>1003070</b>
890lm   3000K   CRI>80	
■ black	<b>114390</b>
890lm   3000K   CRI>80	
□ white	<b>114391</b>
890lm   3000K   CRI>80	
▒ brushed aluminium	<b>114396</b>

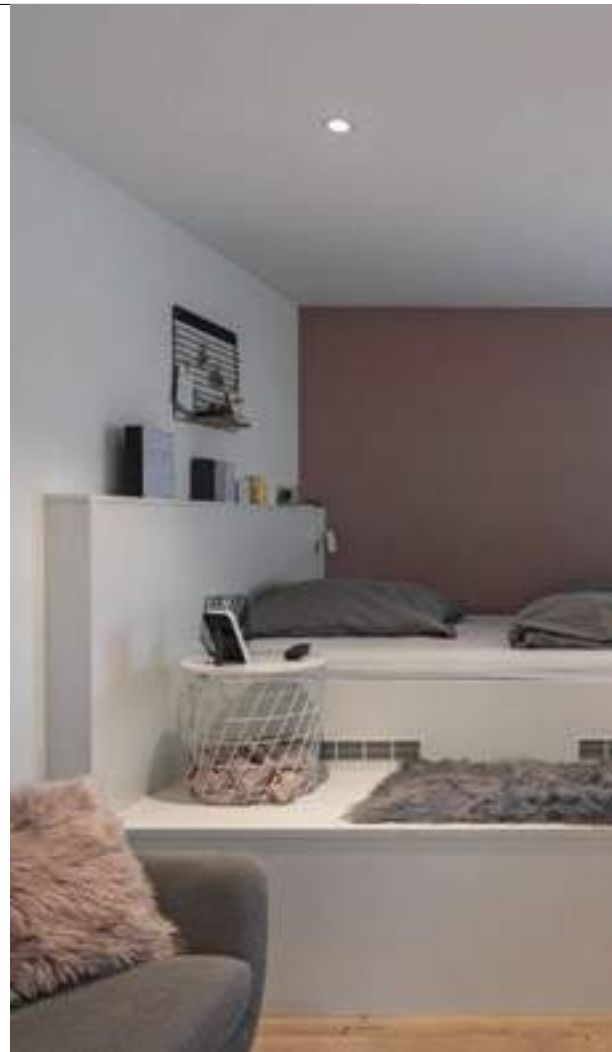



1001989 429



1001991 429

**NEW TRIA 68**  
Single, round, CS/LS, PHASE



- Premium LED with CRI>90
- Dim to Warm (1800-3000K)
- Installation height <40mm

**Product details**

220-240V ~50/60Hz | 350mA  
Total wattage: 7.3W  
Material: aluminium  
Dimmable: C, L

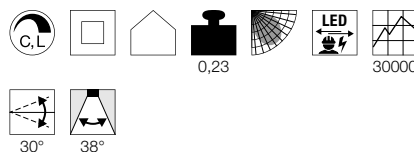

**Dimensional drawing**

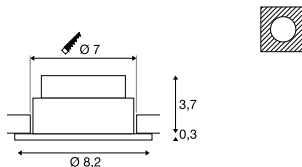

**Tip**

Material thickness of mounting surface:  
20 mm

Variant	Item No.
440lm   1800-3000K   CRI>95	
■ black	<b>1001978</b>
440lm   1800-3000K   CRI>95	
□ white	<b>1001989</b>
440lm   1800-3000K   CRI>95	
■ brushed aluminium	<b>1001990</b>

**NEW TRIA 68**  
Single, square, CS/LS, PHASE



- Premium LED with CRI>90
- Dim to Warm (1800-3000K)
- Installation height <40mm

**Product details**

220-240V ~50/60Hz | 350mA  
Total wattage: 7.3W  
Material: aluminium  
Dimmable: C, L

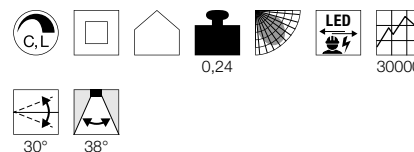

**Dimensional drawing**

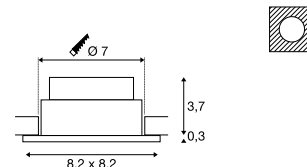

**Tip**

Material thickness of mounting surface:  
20 mm

Variant	Item No.
440lm   1800-3000K   CRI>95	
■ black	<b>1001991</b>
440lm   1800-3000K   CRI>95	
□ white	<b>1001992</b>
440lm   1800-3000K   CRI>95	
■ brushed aluminium	<b>1001993</b>

**NEW TRIA 77**  
Single, round, CS

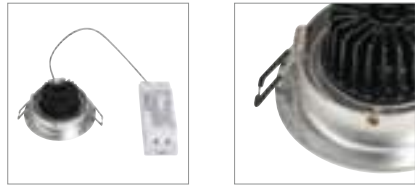

**Product details**

220-240V ~50/60Hz | 350mA  
Total wattage: 8W  
Material: aluminium

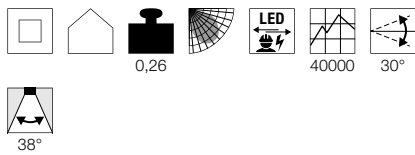

**Dimensional drawing**

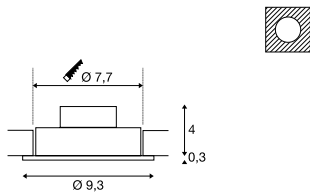

**Tip**

Spring clips  
Material thickness of mounting surface:  
max. 20 mm

**NEW TRIA 77**  
Single, square, CS

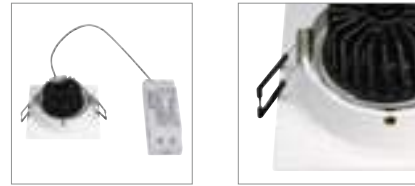

**Product details**

220-240V ~50/60Hz | 350mA  
Total wattage: 8W  
Material: aluminium

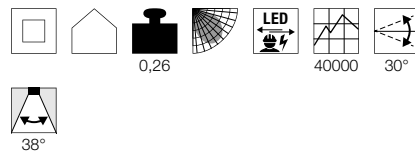

**Dimensional drawing**

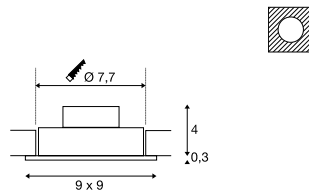

**Tip**

Spring clips  
Material thickness of mounting surface:  
max. 20 mm

Variant	Item No.
645lm   2700K   CRI>80 ■ black	<b>113870</b>
645lm   2700K   CRI>80 □ white	<b>113871</b>
645lm   2700K   CRI>80 ■ aluminium	<b>113876</b>
700lm · 3000K · CRI>80 ■ black	<b>113900</b>
700lm · 3000K · CRI>80 □ white	<b>113901</b>
700lm · 3000K · CRI>80 ■ aluminium	<b>113906</b>

Variant	Item No.
645lm   2700K   CRI>80 ■ black	<b>113880</b>
645lm   2700K   CRI>80 □ white	<b>113881</b>
645lm   2700K   CRI>80 ■ aluminium	<b>113886</b>
700lm · 3000K · CRI>80 ■ black	<b>113910</b>
700lm · 3000K · CRI>80 □ white	<b>113911</b>
700lm · 3000K · CRI>80 ■ aluminium	<b>113916</b>



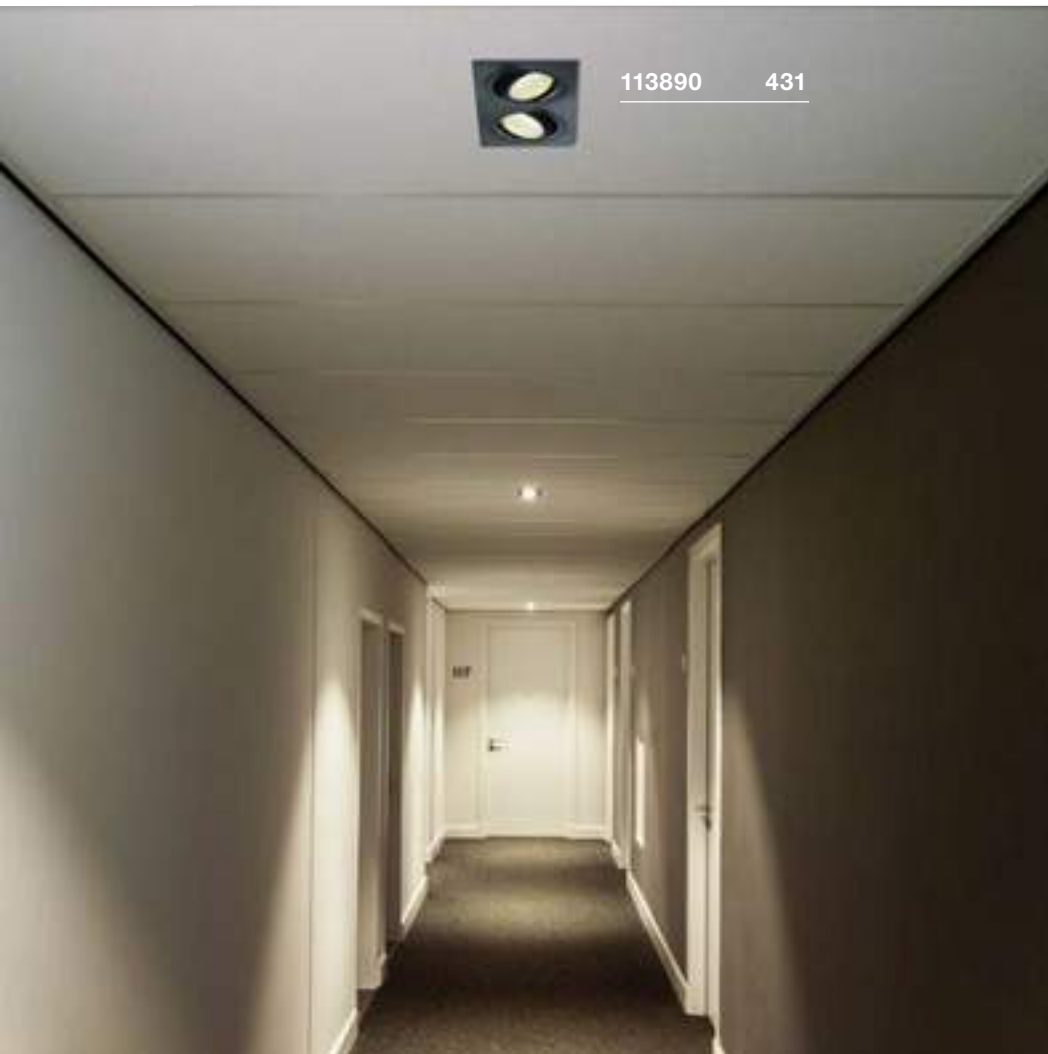

113890 431

**NEW TRIA 155**  
Double, CS

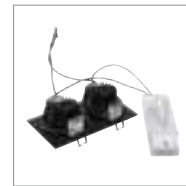

**Product details**

220-240V ~50/60Hz | 350mA  
Total wattage: 14W  
Material: aluminium

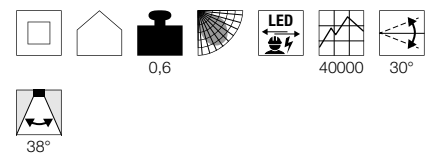

**Dimensional drawing**

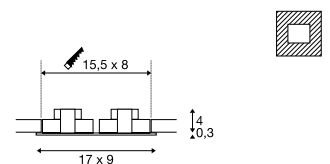

**Tip**

Spring clips  
Material thickness of mounting surface:  
max. 30 mm



113926 431

Variant	Item No.
1160lm   2700K   CRI>80	
■ black	<b>113890</b>
1160lm   2700K   CRI>80	
□ white	<b>113891</b>
1160lm   2700K   CRI>80	
■ aluminium	<b>113896</b>
1250lm   3000K   CRI>80	
■ black	<b>113920</b>
1250lm   3000K   CRI>80	
□ white	<b>113921</b>
1250lm   3000K   CRI>80	
■ aluminium	<b>113926</b>

114271 433

## NEW TRIA 110

Single, round, CS, PHASE



### Product details

220-240V ~50/60Hz | 350mA  
 Total wattage: 15W  
 Material: aluminium  
 Dimmable: C, L

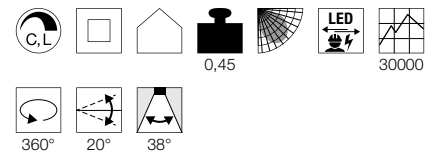

### Dimensional drawing

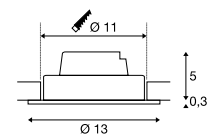

### Tip

Spring clips  
 Material thickness of mounting surface:  
 max. 20 mm

Variant	Item No.
1010lm   2700K   CRI>80	
■ black	<b>114220</b>
1030lm   2700K   CRI>80	
□ white	<b>114221</b>
1100lm   3000K   CRI>80	
■ black	<b>114230</b>
1120lm   3000K   CRI>80	
□ white	<b>114231</b>





**NEW TRIA 110**  
Single, square, CS, PHASE



**Product details**

220-240V ~50/60Hz | 350mA  
Total wattage: 15W  
Material: aluminium  
Dimmable: C, L

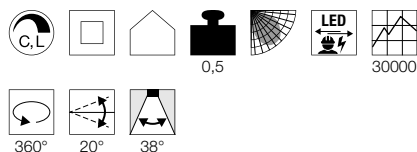

**Dimensional drawing**

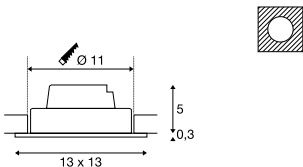

**Tip**

Spring clips  
Material thickness of mounting surface:  
max. 20 mm

Variant	Item No.
1010lm   2700K   CRI>80	
■ black	<b>114240</b>
□ white	<b>114241</b>
1100lm   3000K   CRI>80	
■ black	<b>114250</b>
□ white	<b>114251</b>

**NEW TRIA 150**  
Single, round, CS, 1-10V



**Product details**

100-240V ~50/60Hz | 700mA  
Total wattage: 29W  
Material: aluminium  
Dimmable: 1-10V

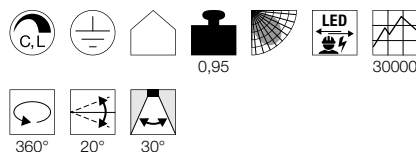

**Dimensional drawing**

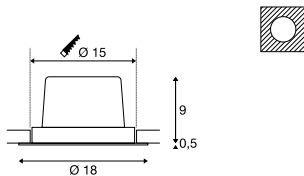

**Tip**

Spring clips  
Material thickness of mounting surface:  
max. 20 mm

Variant	Item No.
2210lm   2700K   CRI>80	
■ black	<b>114260</b>
□ white	<b>114261</b>
2425lm   3000K   CRI>80	
■ black	<b>114270</b>
□ white	<b>114271</b>

**NEW TRIA 150**  
Single, square, CS, 1-10V



**Product details**

100-240V ~50/60Hz | 700mA  
Total wattage: 29W  
Material: aluminium  
Dimmable: 1-10V

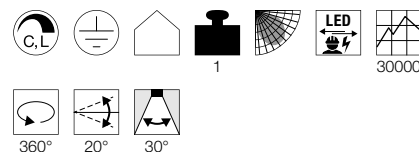

**Dimensional drawing**

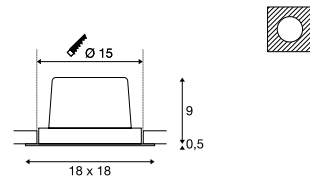

**Tip**

Spring clips  
Material thickness of mounting surface:  
max. 20 mm

Variant	Item No.
2210lm   2700K   CRI>80	
■ black	<b>114280</b>
□ white	<b>114281</b>
2425lm   3000K   CRI>80	
■ black	<b>114290</b>
□ white	<b>114291</b>

**KADUX**  
EL, single, QPAR51

SOCKET INSIDE 



**Product details**

230V -50Hz  
Material: aluminium/steel



**Dimensional drawing**

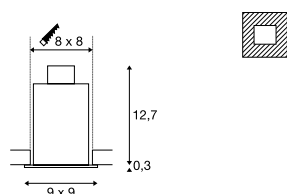

**Tip**

Material thickness of mounting surface:  
max. 30 mm

**Recommended lamp**

LED GU10 5.5W 38°  
2700K 400lm  
6kWh/1000h  
Item No. 1001030



LED 6W 36°  
2700K 460lm  
6kWh/1000h  
Item No. 1005075



**Lamp details**

max. 50W QPAR51

Variant	Item No.
GU10   QPAR51	
■ black	115510
GU10   QPAR51	
□ white	115511
GU10   QPAR51	
▒ aluminium	115516

**KADUX**  
EL, double, QPAR51

SOCKET INSIDE 



**Product details**

230V -50Hz  
Material: aluminium/steel



**Dimensional drawing**

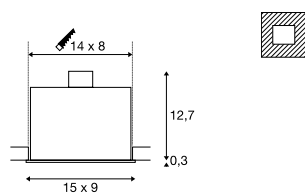

**Tip**

Material thickness of mounting surface:  
max. 30 mm

**Recommended lamp**

LED GU10 6W 36°  
3000K 460lm  
6kWh/1000h  
Item No. 1005078



LED GU10 6W 36°  
4000K 460lm  
6kWh/1000h  
Item No. 1005081



**Lamp details**

2x max. 50W QPAR51

Variant	Item No.
GU10   QPAR51	
■ black	115520
GU10   QPAR51	
□ white	115521
GU10   QPAR51	
▒ aluminium	115526

**KADUX**  
EL, triple, QPAR51

SOCKET INSIDE 



**Product details**

230V -50Hz  
Material: aluminium/steel



**Dimensional drawing**

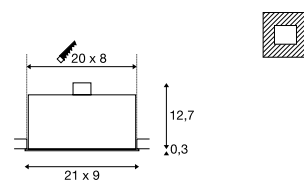

**Tip**

Material thickness of mounting surface:  
max. 30 mm

**Recommended lamp**

LED GU10 4W 36°  
2700K 300lm  
4kWh/1000h  
Item No. 1004972



LED GU10 4W 36°  
3000K 300lm  
4kWh/1000h  
Item No. 1004973



**Lamp details**

3x max. 50W QPAR51

Variant	Item No.
GU10   QPAR51	
■ black	115530
GU10   QPAR51	
□ white	115531
GU10   QPAR51	
▒ aluminium	115536



115551 435

**KADUX**  
EL, single, QPAR111

SOCKET  
INSIDE



**Product details**

230V -50Hz  
Material: aluminium/steel



1,1

**Dimensional drawing**

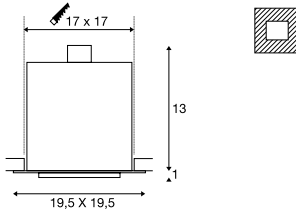

**Tip**

Material thickness of mounting surface:  
max. 25 mm

**Recommended lamp**

LED GU10 13W 55°  
2700K 840lm  
13kWh/1000h  
Item No. 1003094



LED GU10 6.5W 38°  
2700K 390lm  
7kWh/1000h  
Item No. 551882



**Lamp details**

max. 75W QPAR111

Variant	Item No.
GU10   QPAR111	
■ black	115540
□ white	115541
□ aluminium	115546

**KADUX**  
EL, double, QPAR111

SOCKET  
INSIDE



**Product details**

230V -50Hz  
Material: aluminium/steel



1,9

**Dimensional drawing**

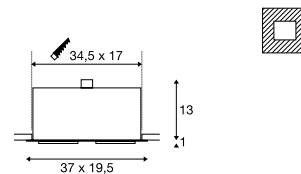

**Tip**

Material thickness of mounting surface:  
max. 25 mm

**Recommended lamp**

LED GU10 13W 30°  
2700K 1100lm  
13kWh/1000h  
Item No. 1001242



LED GU10 7W 25°  
3000K 730lm  
8kWh/1000h  
Item No. 1001570



**Lamp details**

2x max. 75W QPAR111

Variant	Item No.
GU10   QPAR111	
■ black	115550
□ white	115551
□ aluminium	115556



115536 434

**KADUX**  
EL, single, PHASE



**KADUX**  
EL, double, PHASE



**KADUX**  
EL, triple, PHASE



**Product details**

220-240V ~50/60Hz | 350mA  
Total wattage: 7.5W  
Material: aluminium/steel  
Dimmable: C, L

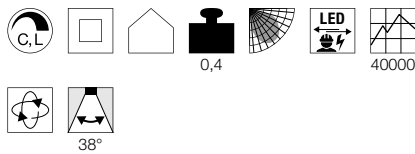

**Product details**

220-240V ~50/60Hz | 350mA  
Total wattage: 14W  
Material: aluminium/steel  
Dimmable: C, L

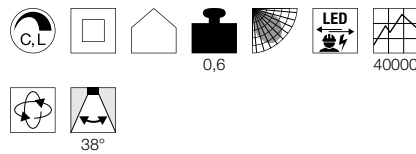

**Product details**

220-240V ~50/60Hz | 350mA  
Total wattage: 20W  
Material: aluminium/steel  
Dimmable: C, L

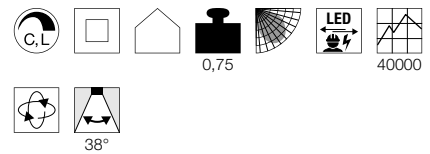

**Dimensional drawing**

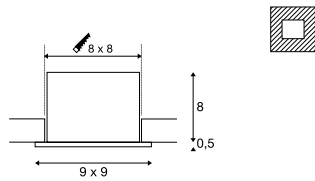

**Dimensional drawing**

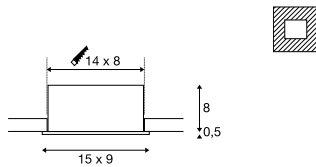

**Dimensional drawing**

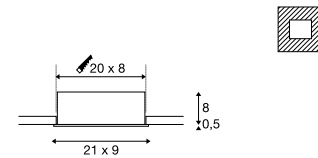

**Tip**

Material thickness of mounting surface:  
max. 30 mm

**Tip**

Material thickness of mounting surface:  
max. 30 mm

**Tip**

Material thickness of mounting surface:  
max. 30 mm

Variant	Item No.
650lm   3000K   CRI>80	
■ black	<b>115700</b>
650lm   3000K   CRI>80	
□ white	<b>115701</b>
650lm   3000K   CRI>80	
▒ aluminium	<b>115706</b>

Variant	Item No.
1290lm   3000K   CRI>80	
■ black	<b>115710</b>
1290lm   3000K   CRI>80	
□ white	<b>115711</b>
1290lm   3000K   CRI>80	
▒ aluminium	<b>115716</b>

Variant	Item No.
1920lm   3000K   CRI>80	
■ black	<b>115720</b>
1920lm   3000K   CRI>80	
□ white	<b>115721</b>
1920lm   3000K   CRI>80	
▒ aluminium	<b>115726</b>



115700 436



115711 436

**KADUX**  
EL, single, 1-10V



**Product details**

100-240V ~50/60Hz | 700mA  
Total wattage: 29W  
Material: aluminium/steel  
Dimmable: 1-10V

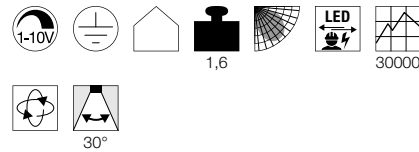

**Dimensional drawing**

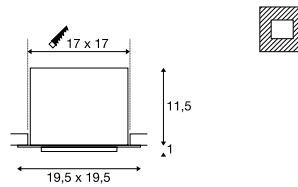

**Tip**

Material thickness of mounting surface:  
max. 25 mm

**Accessory recommendation**

1-10V dimming  
Item No. 470505

Variant	Item No.
2425lm   3000K   CRI>80	
■ black	115730
250lm · 3000K · CRI>80	
□ white	115731
250lm · 3000K · CRI>80	
□ aluminium	115736

**KADUX**  
EL, double, 1-10V



**Product details**

100-240V ~50/60Hz | 1400mA  
Total wattage: 54W  
Material: aluminium/steel  
Dimmable: 1-10V

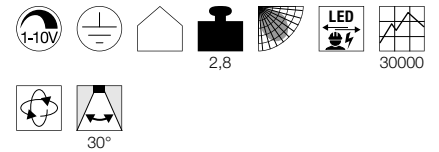

**Dimensional drawing**

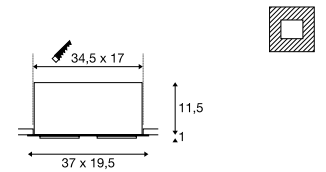

**Tip**

Material thickness of mounting surface:  
max. 25 mm

**Accessory recommendation**

1-10V dimming  
Item No. 470505

Variant	Item No.
5200lm   3000K   CRI>80	
■ black	115740
5300lm   3000K   CRI>80	
□ white	115741
5300lm   3000K   CRI>80	
□ aluminium	115746

**AIXLIGHT® PRO 50**  
LED Module



**Product details**

350mA | 13.3W  
Material: aluminium/glass

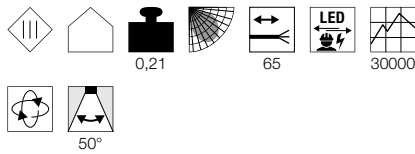

0,21

65

30000

50°

**Dimensional drawing**

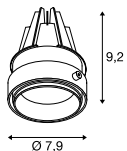

**Tip**

Driver not included  
Open cable end

**Accessory recommendation**

LED driver 350mA | 15W  
Item No. 1002803



Variant	Item No.
1150lm   3000K   CRI>80 ■ white/black	1002598
1150lm   3000K   CRI>80 ■ grey/black	1002599
1185lm   4000K   CRI>80 ■ white/black	1002600
1185lm   4000K   CRI>80 ■ grey/black	1002601

**AIXLIGHT® PRO 50**  
QPAR51 Module



**Product details**

230V -50Hz  
Material: aluminium/plastic



0,01

65

**Dimensional drawing**

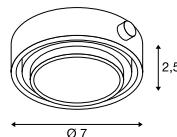

**Recommended lamp**

LED GU10 6W 36°  
3000K 460lm  
6kWh/1000h  
Item No. 1005080



LED GU10 6W 36°  
4000K 460lm  
6kWh/1000h  
Item No. 1005083



**Lamp details**

max. 50W QPAR51  
Diameter: 5cm max. L: 5.7cm max.

Variant	Item No.
GU10   QPAR51 ■ grey/black	115414



115351 + 1002600 438

**AIXLIGHT® PRO 50 1 FRAMELESS**

Steel  
L: 10.2 cm W: 10.2 cm T: 10.5 cm  
Weight: 0.77 kg  
1 piece



Variant	Item No.
■ black	115351

**AIXLIGHT® PRO 50 2 FRAMELESS**

Steel  
L: 18.8 cm W: 10.2 cm T: 10.5 cm  
Weight: 1.09 kg  
1 piece

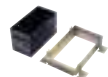

Variant	Item No.
■ black	115352



**AIXLIGHT® PRO**  
EL, QPAR111 Module



SOCKET  
INSIDE



**Product details**

230V -50Hz  
Material: aluminium/plastic



**Dimensional drawing**

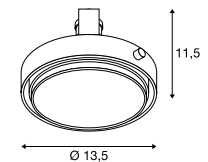

**Recommended lamp**

LED GU10 13W 55°  
4000K 950lm  
13kWh/1000h  
Item No. 1003095



LED GU10 13W 30°  
4000K 1100lm  
13kWh/1000h  
Item No. 1003087



**Lamp details**

max. 75W QPAR111

Variant	Item No.
GU10   QPAR111 □ matt white	115011
GU10   QPAR111 ■ grey/black	115014

**AIXLIGHT® PRO 1 FRAMELESS**

Steel  
L: 15.5 cm W: 15.5 cm T: 18.5 cm  
Weight: 2.15kg  
1 piece

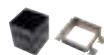

Variant	Item No.
■ black	115151

**AIXLIGHT® PRO 2 FRAMELESS**

Steel  
L: 31.5 cm W: 15.5 cm T: 18.5 cm  
Weight: 3.5 kg  
1 piece



Variant	Item No.
■ black	115152

SUPROS 78  
EL, PHASELED  
INSIDE

## Product details

220-240V ~50/60Hz | 250mA  
 Total wattage: 12W  
 Material: aluminium  
 Dimmable: C, L

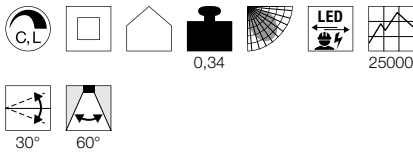

## Dimensional drawing

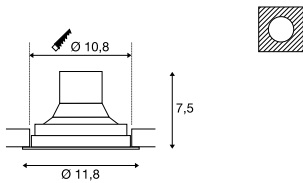

## Tip

Material thickness of mounting surface:  
 max. 25 mm

## Accessory recommendation

Lens 20°

Item No. 116302

Lens 40°

Item No. 116304

Variant	Item No.
700lm   3000K   CRI>80   60°	
■ black	116310
700lm   3000K   CRI>80   60°	
□ white	116311





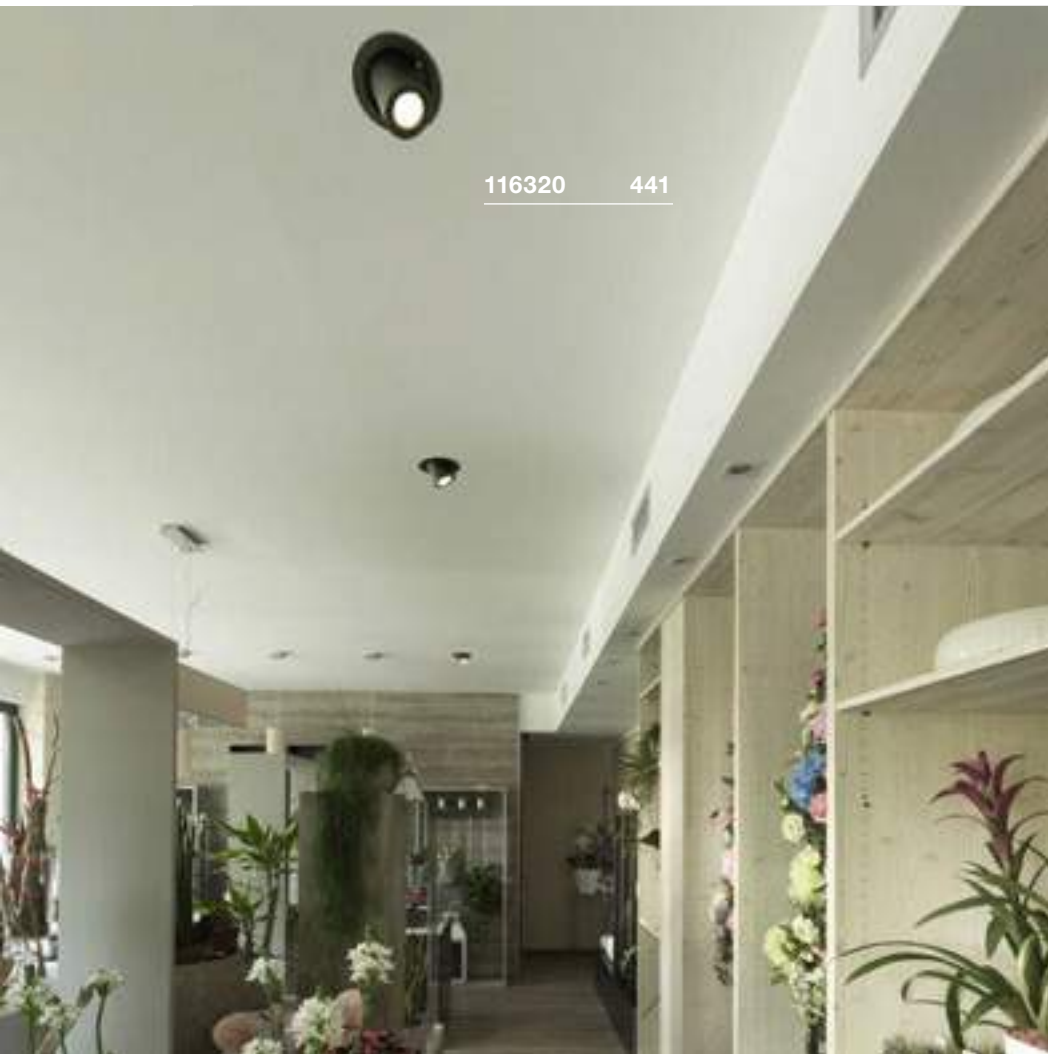

116320 441

SUPROS 78  
EL, Move, PHASE



Product details

220-240V ~50/60Hz | 250mA  
Total wattage: 12W  
Material: aluminium  
Dimmable: C, L

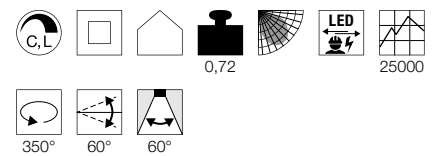

Dimensional drawing

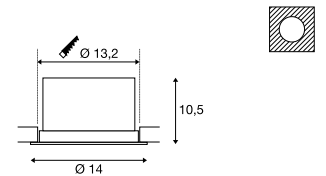

Tip

Material thickness of mounting surface:  
max. 25 mm

Accessory recommendation

- Lens 20°
- Item No. 116302
- Lens 40°
- Item No. 116304

Variant	Item No.
700lm   3000K   CRI>80   60°	
■ black	116320
700lm   3000K   CRI>80   60°	
□ white	116321

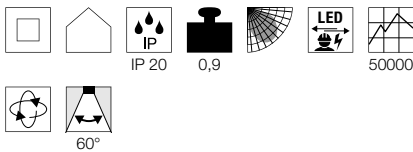
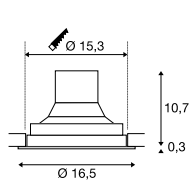

116310 440

SUPROS  
DLFOLLOW  
POWERLED  
INSIDE**Product details**220-240V ~50/60Hz | 750mA  
Material: aluminium**Dimensional drawing****Tip**Material thickness of mounting surface:  
max. 25 mm**Accessory recommendation**

Reflector 20°

Item No. 114102



Reflector 40°

Item No. 114104



Variant	Item No.
2600lm   3000K   CRI>90   31W	
■ black	1003299
2600lm   3000K   CRI>90   31W	
□ white	1003300
2700lm   4000K   CRI>90   31W	
■ black	1003303
2700lm   4000K   CRI>90   31W	
□ white	1003304
3380lm   3000K   CRI>90   36W	
■ black	1003301
3380lm   3000K   CRI>90   36W	
□ white	1003302
3520lm   4000K   CRI>90   36W	
■ black	1003305
3520lm   4000K   CRI>90   36W	
□ white	1003306

1003299 442





1003308 443

SUPROS  
DL, Move



Product details

220-240V ~50/60Hz | 750mA  
Material: aluminium

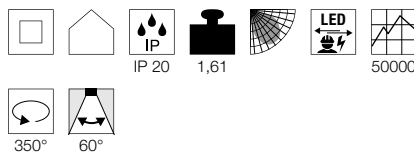

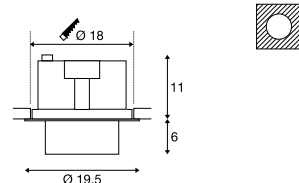

Dimensional drawing



Tip

Material thickness of mounting surface:  
25 mm

Accessory recommendation

- Reflector 20°
- Item No. 114102 
- Reflector 40°
- Item No. 114104 

Variant	Item No.
2600lm   3000K   CRI>90   31W	
■ black	1003307
2600lm   3000K   CRI>90   31W	
□ white	1003308
2700lm   4000K   CRI>90   31W	
■ black	1003311
2700lm   4000K   CRI>90   31W	
□ white	1003312
3380lm   3000K   CRI>90   36W	
■ black	1003309
3380lm   3000K   CRI>90   36W	
□ white	1003310
3520lm   4000K   CRI>90   36W	
■ black	1003313
3520lm   4000K   CRI>90   36W	
□ white	1003314

1004668 445





1004669 445

OCULUS  
CL, Move, PHASE



Product details

220-240V ~50/60Hz | 250mA  
Total wattage: 10.5W  
Material: aluminium/glass  
Dimmable: C



Dimensional drawing

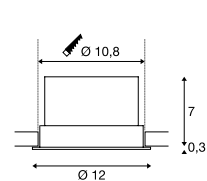

Tip

Material thickness of mounting surface:  
7-20 mm

Variant	Item No.
36-780lm   2000-3000K   CRI>90	
■ matt black	1004668
36-780lm   2000-3000K   CRI>90	
□ matt white	1004669

GIMBLE IN 68  
EL



- Premium LED with CRI>90
- Light emission can be rotated and pivoted

Product details

350mA | 6W  
Material: aluminium

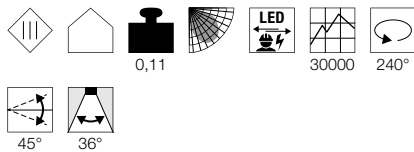

Dimensional drawing

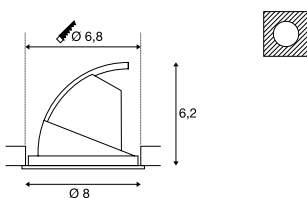

Tip

Material thickness of mounting surface:  
20 mm

Accessory recommendation

LED driver 320mA | 10W  
Item No. 464140



GIMBLE IN 100  
EL



- Premium LED with CRI>90
- Light emission can be rotated and pivoted

Product details

350mA | 13W  
Material: aluminium



Dimensional drawing

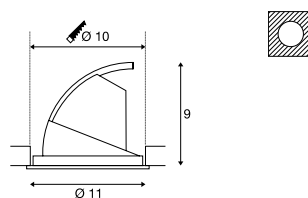

Tip

Material thickness of mounting surface:  
25 mm

Accessory recommendation

LED driver 350mA | 15W  
Item No. 464031



GIMBLE IN 150  
EL



- Premium LED with CRI>90
- Light emission can be rotated and pivoted

Product details

700mA | 25.5W  
Material: aluminium

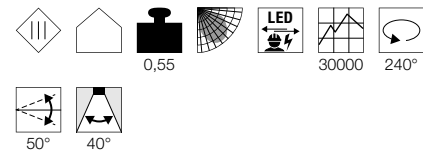

Dimensional drawing

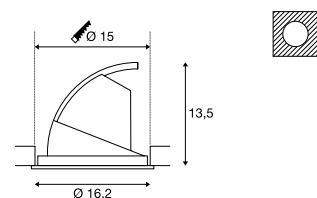

Tip

Material thickness of mounting surface:  
30 mm

Accessory recommendation

LED driver 40W | 700mA | 1-10V/  
DALI dimmable | inc. strain relief  
Item No. 1002424



Variant	Item No.
520lm   3000K   CRI>90 <input type="checkbox"/> white	1002879
560lm   4000K   CRI>90 <input type="checkbox"/> white	1002885

Variant	Item No.
990lm   3000K   CRI>90 <input type="checkbox"/> white	1002880
1140lm   4000K   CRI>90 <input type="checkbox"/> white	1002886

Variant	Item No.
2300lm   3000K   CRI>90 <input type="checkbox"/> white	1002888
2490lm   4000K   CRI>90 <input type="checkbox"/> white	1002889

## GIMBLE IN 175 EL

LED  
INSIDE



- Premium LED with CRI>90
- Light emission can be rotated and pivoted

### Product details

1000mA/1050mA | 38W  
Material: aluminium

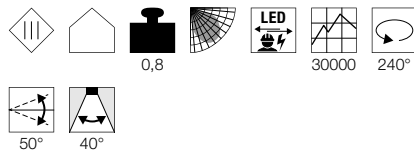

### Dimensional drawing

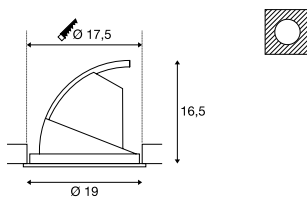

### Tip

Material thickness of mounting surface:  
30 mm

### Accessory recommendation

LED driver 1000mA | 40W |  
dimmmable | inc. strain relief

Item No. **1001115**

LED driver 50W | 1050mA | 1-10V/  
DALI dimmmable | inc. strain relief

Item No. **1002425**

Variant	Item No.
3340lm   3000K   CRI>90 <input type="checkbox"/> white	<b>1002881</b>
3550lm   4000K   CRI>90 <input type="checkbox"/> white	<b>1002887</b>

1002880 447



**SENSER**  
EL, round



- Low installation depth

**Product details**

Material: aluminium

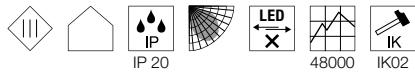

**Tip**

Driver not included



1003008 448

**SENSER 12**  
EL, round



**Dimensional drawing**

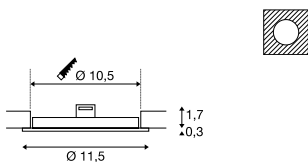

**Accessory recommendation**

LED driver 200mA | 5-8.4W  
Item No. 1003254



Variant	Item No.
470lm   3000K   CRI>80 200mA   6W   0.1 kg <input type="checkbox"/> white	1003008
470lm   4000K   CRI>90 200mA   6W   0.1 kg <input type="checkbox"/> white	1004694

**SENSER 18**  
EL, round



**Dimensional drawing**

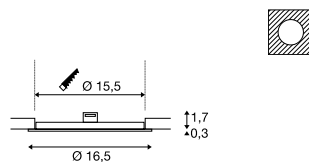

**Accessory recommendation**

LED driver 320mA | 10W  
Item No. 464140



Variant	Item No.
950lm   3000K   CRI>80 350mA   9.7W   0.18 kg <input type="checkbox"/> white	1003009
950lm   4000K   CRI>90 350mA   9.7W   0.18 kg <input type="checkbox"/> white	1004695

**SENSER 24**  
EL, round



**Dimensional drawing**

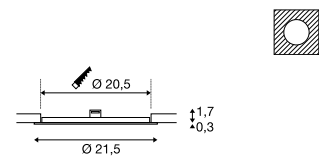

**Accessory recommendation**

LED Driver 500mA | 15W dimmable  
Item No. 464144



Variant	Item No.
1200lm   3000K   CRI>80 500mA   12.5W   0.29 kg <input type="checkbox"/> white	1003010
1200lm   4000K   CRI>90 500mA   12.5W   0.29 kg <input type="checkbox"/> white	1004696



**SENSER**  
EL, square



- Low installation depth

**Product details**

Material: aluminium

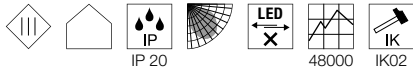

**Tip**

Driver not included

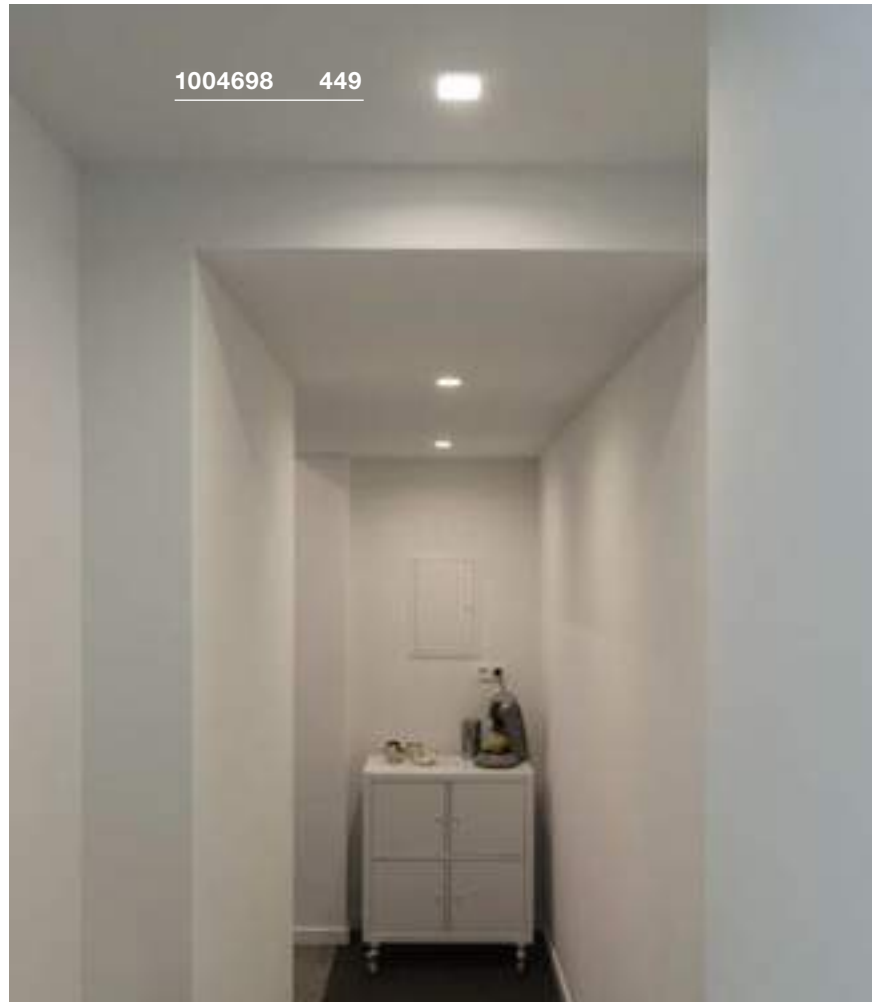

**SENSER 12**  
EL, square



**Dimensional drawing**

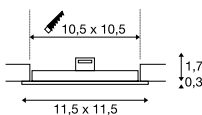

**Accessory recommendation**

LED driver 200mA | 5-8.4W  
Item No. **1003254**



Variant	Item No.
440lm   3000K   CRI>80 200mA   6W   0.12 kg <input type="checkbox"/> white	<b>1003011</b>
440lm   4000K   CRI>90 200mA   6W   0.12 kg <input type="checkbox"/> white	<b>1004697</b>

**SENSER 18**  
EL, square



**Dimensional drawing**

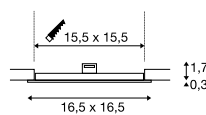

**Accessory recommendation**

LED driver 320mA | 10W  
Item No. **464140**



Variant	Item No.
820lm   3000K   CRI>80 350mA   9.7W   0.22 kg <input type="checkbox"/> white	<b>1003012</b>
820lm   4000K   CRI>90 350mA   9.7W   0.22 kg <input type="checkbox"/> white	<b>1004698</b>

**SENSER 24**  
EL, square

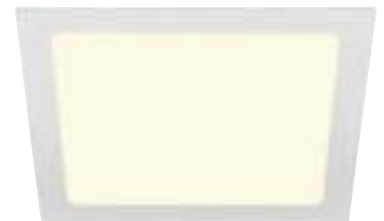

**Dimensional drawing**

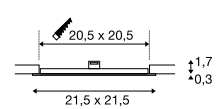

**Accessory recommendation**

LED Driver 500mA | 15W dimmable  
Item No. **464144**



Variant	Item No.
1200lm   3000K   CRI>80 500mA   12.5W   0.36 kg <input type="checkbox"/> white	<b>1003013</b>
1200lm   4000K   CRI>90 500mA   12.5W   0.36 kg <input type="checkbox"/> white	<b>1004699</b>



112682 451



112702 451



VERLUX  
EL, square, PHASE



Product details

220-240V ~50/60Hz | 500mA  
Total wattage: 12W  
Material: aluminium/plastic  
Dimmable: C, L

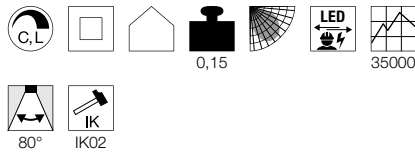

Dimensional drawing

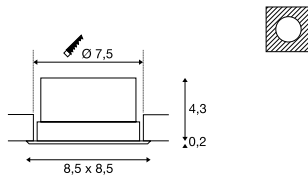

Tip

Material thickness of mounting surface:  
max. 30 mm

Variant	Item No.
880lm   3000K   CRI>80 □ white	112682

VERLUX  
EL, square, PHASE



Product details

220-240V ~50/60Hz | 500mA  
Total wattage: 22W  
Material: aluminium/plastic  
Dimmable: C, L

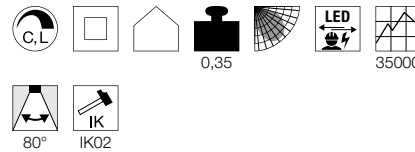

Dimensional drawing

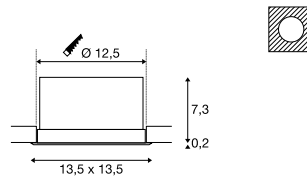

Tip

Material thickness of mounting surface:  
max. 30 mm

Variant	Item No.
1800lm · 3000K · CRI>80 □ white	112692

VERLUX  
EL, square, PHASE



Product details

220-240V ~50/60Hz | 700mA  
Total wattage: 31W  
Material: aluminium/plastic  
Dimmable: C, L

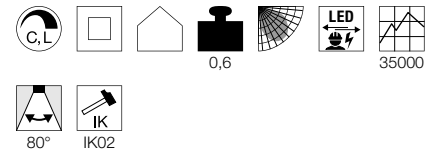

Dimensional drawing

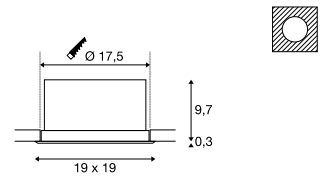

Tip

Material thickness of mounting surface:  
max. 30 mm

Variant	Item No.
2360lm   3000K   CRI>80 □ white	112702

ALAMEA  
ELLED  
INSIDE

- Premium LED with CRI>90
- Large pivot range

## Product details

1000mA | 36W  
Material: aluminium/glass



2,2

35000

60°

## Dimensional drawing

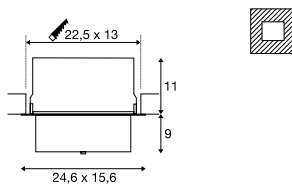

## Tip

Material thickness of mounting surface:  
max. 40 mm

## Accessory recommendation

■ LED driver 1000mA |  
40W inc. strain relief

Item No. 464170

□ LED driver 350-1050mA | 50W |  
Dali 1-10V dimmable

Item No. 464032

□ LED driver 1000mA | 40W |  
dimmable | inc. strain relief

Item No. 1001115



Variant	Item No.
3600lm   3000K   CRI>90	
□ white	1000792
3800lm   4000K   CRI>90	
□ white	1000794

1000794 452



1003024 470



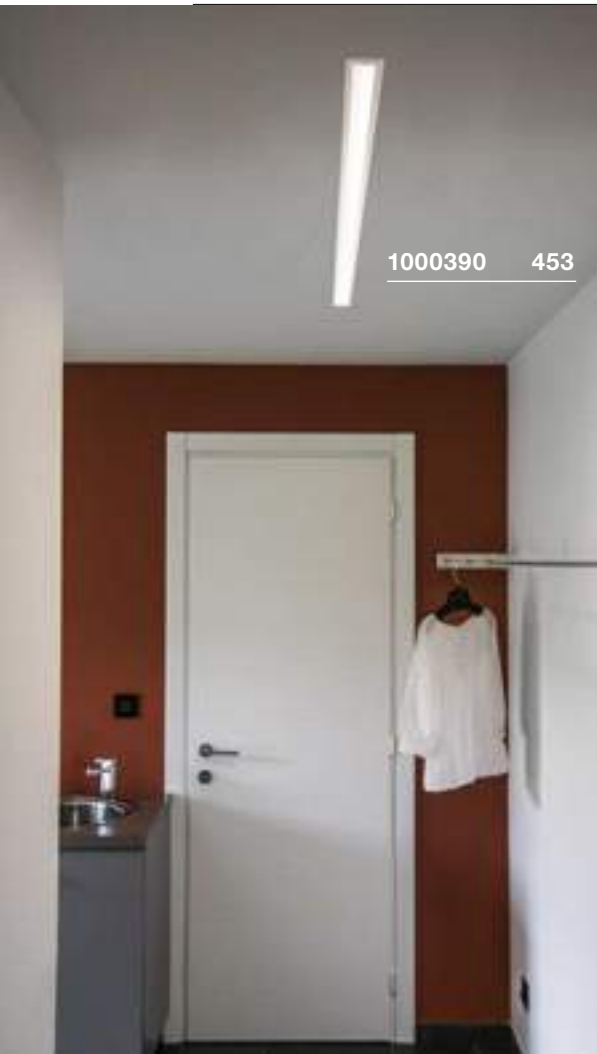

1000390 453



1000390 453

**ANINDA 60**  
EL

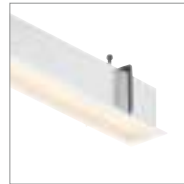

**Product details**

700mA | 16W  
Material: aluminium/acrylic



1,05

90°

**Dimensional drawing**

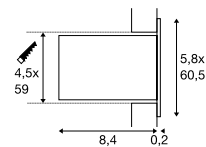

**Tip**

Material thickness of mounting surface:  
max. 15 mm

**Accessory recommendation**

LED driver 350-1050mA | 50W |  
Dali 1-10V dimmable  
**Item No. 464032**

LED driver 25W | 700mA |  
dimmable | inc. strain relief  
**Item No. 1001133**

LED driver 20W | 700mA  
**Item No. 1001136**



Variant	Item No.
1040lm   3000K   CRI>80 <input type="checkbox"/> white	<b>1000387</b>

**ANINDA 120**  
EL

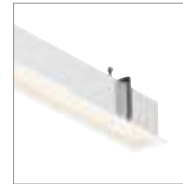

**Product details**

700mA | 16W  
Material: aluminium/acrylic

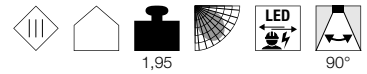

1,95

90°

**Dimensional drawing**

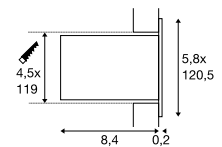

**Tip**

Material thickness of mounting surface:  
max. 15 mm

**Accessory recommendation**

LED driver 350-1050mA | 50W |  
Dali 1-10V dimmable  
**Item No. 464032**

LED driver 25W | 700mA |  
dimmable | inc. strain relief  
**Item No. 1001132**

LED driver 700mA |  
40W inc. strain relief  
**Item No. 464168**



Variant	Item No.
2230lm   3000K   CRI>80 <input type="checkbox"/> white	<b>1000390</b>

MEDO 30  
EL, FRAMELESS



- Colour temperature (3000K/4000K) can be adjusted using the switch

Product details

350mA | 14W  
Material: aluminium/polymethylacrylate (PMMA)  
Installation dimensions: T: 13 cm

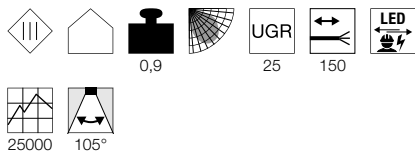

Dimensional drawing

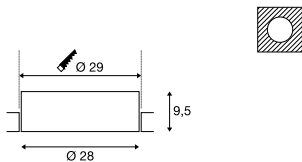

Tip

- Open cable end
- Material thickness of mounting surface: 45 mm
- Driver not included

Accessory recommendation

- LED driver 20W | 350mA | inc. strain relief  
**Item No. 1002420**
- LED driver 20W | 350mA | 1-10V/ DALI dimmable | inc. strain relief  
**Item No. 1002423**
- LED driver 20W | 350mA | dimmable | inc. strain relief  
**Item No. 1002232**

Variant	Item No.
1500/1600lm   3000/4000K   CRI>80	
<input type="checkbox"/> white	<b>1001901</b>

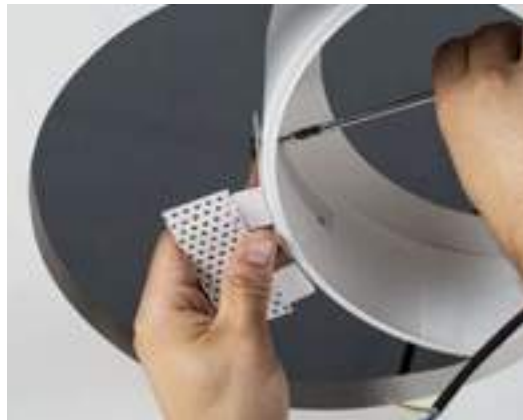

MEDO 40  
EL, FRAMELESS



- Colour temperature (3000K/4000K) can be adjusted using the switch

Product details

700mA | 28W  
Material: aluminium/polymethylacrylate (PMMA)  
Installation dimensions: T: 13 mm

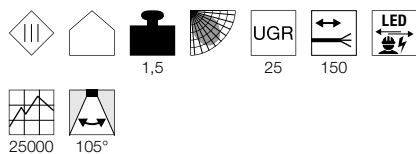

Dimensional drawing

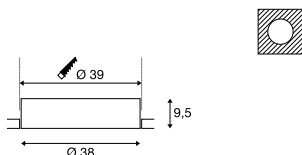

Tip

Open cable end  
Material thickness of mounting surface:  
45 mm  
Driver not included

Accessory recommendation

- LED driver 700mA | 40W inc. strain relief  
**Item No. 464168**
- LED driver 40W | 700mA | 1-10V/ DALI dimmable | inc. strain relief  
**Item No. 1002424**

Variant	Item No.
3100/3300lm   3000/4000K   CRI>80	
□ white	<b>1001902</b>

MEDO 60  
EL, FRAMELESS



- Colour temperature (3000K/4000K) can be adjusted using the switch

Product details

1000mA/1050mA | 36W  
Material: aluminium/polymethylacrylate (PMMA)  
Installation dimensions: T: 16 mm

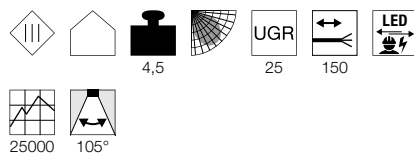

Dimensional drawing

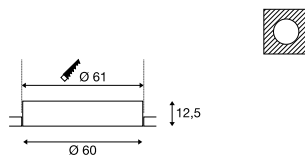

Tip

Open cable end  
Material thickness of mounting surface:  
45 mm  
Driver not included

Accessory recommendation

- LED driver 60W | 1000mA | inc. strain relief  
**Item No. 1002422**
- LED driver 50W | 1050mA | 1-10V/ DALI dimmable | inc. strain relief  
**Item No. 1002425**
- LED driver 1000mA | 40W | dimmable | inc. strain relief  
**Item No. 1001115**

Variant	Item No.
4700/5000lm   3000/4000K   CRI>80	
□ white	<b>1001903</b>

MEDO 90  
EL, FRAMELESS

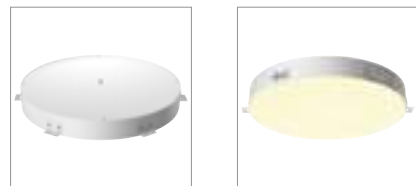

- Colour temperature (3000K/4000K) can be adjusted using the switch

Product details

1000mA/1050mA | 2x36W  
Material: aluminium/polymethylacrylate (PMMA)  
Installation dimensions: T: 21 mm

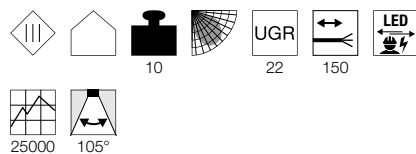

Dimensional drawing

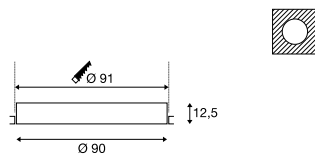

Tip

Open cable end  
Material thickness of mounting surface:  
45 mm  
2 LED drivers are required.  
Driver not included

Accessory recommendation

- LED driver 60W | 1000mA | inc. strain relief  
**Item No. 1002422**
- LED driver 50W | 1050mA | 1-10V/ DALI dimmable | inc. strain relief  
**Item No. 1002425**
- LED driver 1000mA | 40W | dimmable | inc. strain relief  
**Item No. 1001115**

Variant	Item No.
9550/10150lm   3000/4000K   CRI>80	
□ white	<b>1001904</b>

MEDO 30  
EL, FRAME



- Colour temperature (3000K/4000K) can be adjusted using the switch

Product details

350mA | 14W  
Material: aluminium/polymethylacrylate (PMMA)  
Installation dimensions: T: 13 cm

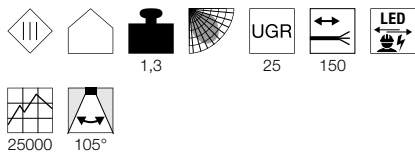

Dimensional drawing

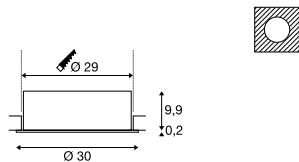

Tip

Open cable end  
Material thickness of mounting surface:  
10-35 mm  
Driver not included

Accessory recommendation

- LED driver 20W | 350mA | inc. strain relief  
**Item No. 1002420**
- LED driver 20W | 350mA | 1-10V/ DALI dimmable | inc. strain relief  
**Item No. 1002423**
- LED driver 20W | 350mA | dimmable | inc. strain relief  
**Item No. 1002232**

Variant	Item No.
1500/1600lm   3000/4000K   CRI>80	
□ white	<b>1001905</b>

MEDO 40  
EL, FRAME



- Colour temperature (3000K/4000K) can be adjusted using the switch

Product details

700mA | 28W  
Material: aluminium/polymethylacrylate (PMMA)  
Installation dimensions: T: 13 cm

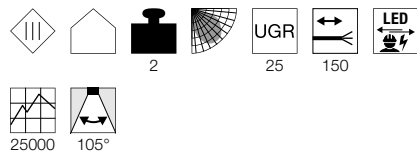

Dimensional drawing

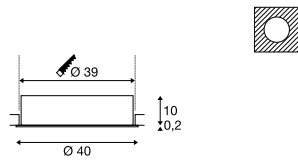

Tip

Open cable end  
Material thickness of mounting surface:  
10-35 mm  
Driver not included

Accessory recommendation

- LED driver 700mA | 40W inc. strain relief  
**Item No. 464168**
- LED driver 40W | 700mA | 1-10V/ DALI dimmable | inc. strain relief  
**Item No. 1002424**

Variant	Item No.
3100/3300lm   3000/4000K   CRI>80	
□ white	<b>1001906</b>

MEDO 60  
EL, FRAME



- Colour temperature (3000K/4000K) can be adjusted using the switch

Product details

1000mA/1050mA | 36W  
Material: aluminium/polymethylacrylate (PMMA)  
Installation dimensions: T: 16 cm

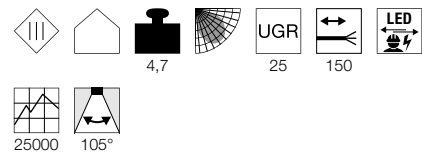

Dimensional drawing

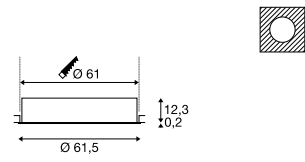

Tip

Open cable end  
Material thickness of mounting surface:  
10-35 mm  
Driver not included

Accessory recommendation

- LED driver 60W | 1000mA | inc. strain relief  
**Item No. 1002422**
- LED driver 50W | 1050mA | 1-10V/ DALI dimmable | inc. strain relief  
**Item No. 1002425**
- LED driver 1000mA | 40W | dimmable | inc. strain relief  
**Item No. 1001115**

Variant	Item No.
4700/5000lm   3000/4000K   CRI>80	
□ white	<b>1001907</b>





MEDO 90  
EL, FRAME



- Colour temperature (3000K/4000K) can be adjusted using the switch

Product details

1000mA/1050mA | 2x36W  
Material: aluminium/polymethylacrylate (PMMA)  
Installation dimensions:T: 21 cm

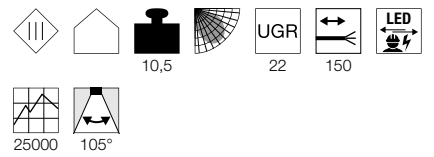

Dimensional drawing

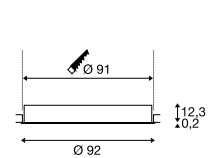

Tip

Open cable end  
Material thickness of mounting surface:  
10-35 mm  
2 LED drivers are required.  
Driver not included

Accessory recommendation

LED driver 60W | 1000mA | inc. strain relief



Item No. 1002422

LED driver 50W | 1050mA | 1-10V/ DALI dimmable | inc. strain relief



Item No. 1002425

LED driver 1000mA | 40W | dimmable | inc. strain relief



Item No. 1001115

Variant	Item No.
9550/10150lm   3000/4000K   CRI>80	
<input type="checkbox"/> white	1001908

## CONNECTED LED PANEL

595x595mm, UGR<19

LED  
INSIDE



1001250 458



- Can be integrated into the VALETO® System

### Product details

100-240V ~50/60Hz | 1050mA  
Total wattage: 43W  
Material: aluminium/acrylic



### Dimensional drawing

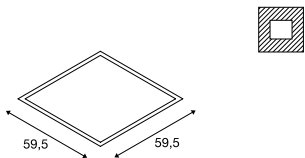

### Tip

Remote control and dimming with Remote Control CCT/DIM [1002994] or Gateway [1002411]

Variant	Item No.
3200-3600lm   2700-6500K   CRI>80 □ white	1001250





1001251 459

**CONNECTED LED PANEL**  
620x620mm, UGR<19

- Can be integrated into the VALETO® System

**Product details**

100-240V ~50/60Hz | 1050mA

Total wattage: 43W

Material: aluminium/acrylic



3,4

19

25000

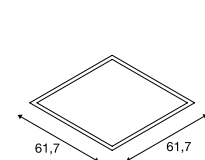

95°

**Dimensional drawing****Tip**

Remote control and dimming with Remote Control CCT/DIM [1002994] or Gateway [1002411]

Variant	Item No.
3200-3600lm   2700-6500K   CRI>80 □ white	1001251

1003073 461

LED PANEL  
620x620mm

- Premium LED with CRI>90
- Suitable for screen-based workstations in line with EN 12464-1
- UGR<19

## Product details

1050mA | 35W  
Material: aluminium/polystyrene (PS)  
Installation dimensions: T: 5 cm

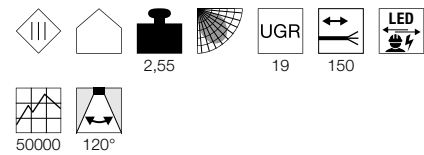

## Dimensional drawing

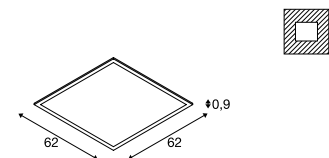

## Tip

Open cable end  
Driver not included

## Accessory recommendation

- LED driver 1050mA | 40W phase-control dimmable  
**Item No. 464804**
- LED driver 50W | 1050mA | 1-10V/ DALI dimmable | inc. strain relief  
**Item No. 1002425**



Variant	Item No.
4000lm   4000K   CRI>90 <input type="checkbox"/> white	1003074

LED PANEL  
620x620mm



- Premium LED with CRI>90
- Suitable for screen-based workstations in line with EN 12464-1
- UGR<19

Product details

1050mA | 35W  
Material: aluminium/polystyrene (PS)  
Installation dimensions: T: 5 cm

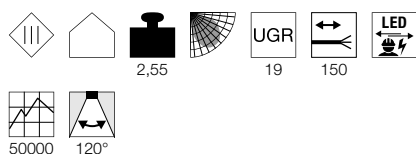

Dimensional drawing

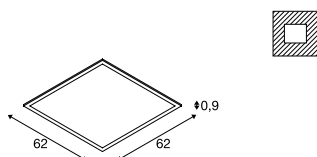

Tip

Open cable end  
Driver not included

Accessory recommendation

- LED driver 1050mA | 40W phase-control dimmable  
**Item No. 464804**
- LED driver 50W | 1050mA | 1-10V/ DALI dimmable | inc. strain relief  
**Item No. 1002425**

Variant	Item No.
4000lm   3000K   CRI>90 <input type="checkbox"/> white	1003073

LED PANEL  
600x600mm



- Premium LED with CRI>90
- Suitable for screen-based workstations in line with EN 12464-1
- UGR<19

Product details

1050mA | 35W  
Material: aluminium/polystyrene (PS)  
Installation dimensions: T: 5 cm

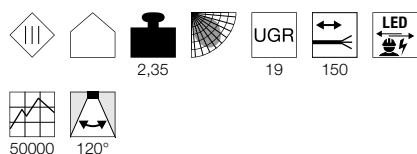

Dimensional drawing

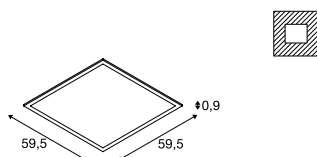

Tip

Open cable end  
Driver not included

Accessory recommendation

- LED driver 1050mA | 40W phase-control dimmable  
**Item No. 464804**
- LED driver 50W | 1050mA | 1-10V/ DALI dimmable | inc. strain relief  
**Item No. 1002425**

Variant	Item No.
4000lm   3000K   CRI>90 <input type="checkbox"/> white	1003083
4000lm   4000K   CRI>90 <input type="checkbox"/> white	1003084

LED PANEL  
300x120mm

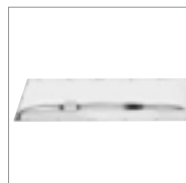

- Premium LED with CRI>90
- Suitable for screen-based workstations in line with EN 12464-1
- UGR<19
- The light colour can be selected during installation using a switch

Product details

900mA | 31W  
Material: aluminium/polystyrene (PS)  
Installation dimensions: T: 5 cm

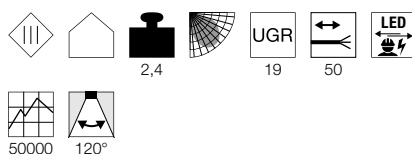

Dimensional drawing

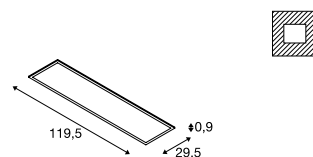

Tip

Open cable end  
Driver not included

Accessory recommendation

- LED driver 50W | 1050mA | 1-10V/ DALI dimmable | inc. strain relief  
**Item No. 1002425**

Variant	Item No.
3600lm   3000/4000K   CRI>90 <input type="checkbox"/> white	1003075



1003076 463

PAVANO  
300x1200mm



- Premium LED with CRI>90
- Suitable for screen-based workstations in line with EN 12464-1
- UGR<19

Product details

700mA | 25W  
Material: steel/polycarbonate (PC)  
Installation dimensions: T: 5 cm

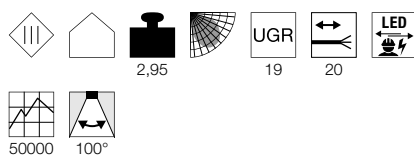

Dimensional drawing

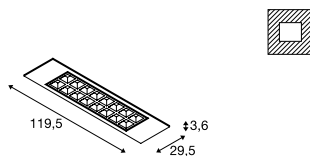

Tip

Open cable end  
Driver not included

Accessory recommendation

□ LED driver 40W | 700mA | 1-10V/  
DALI dimmable | inc. strain relief  
Item No. 1002424



Variant	Item No.
3300lm   3000K   CRI>90	
□ white	1003080
3550lm   4000K   CRI>90	
□ white	1003081

PAVANO  
600x600mm



- Premium LED with CRI>90
- Suitable for screen-based workstations in line with EN 12464-1
- UGR<19

Product details

700mA | 25W  
Material: steel/polycarbonate (PC)  
Installation dimensions: T: 5 cm

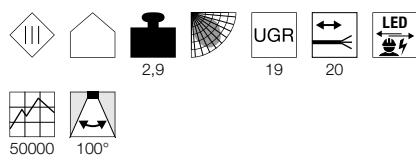

Dimensional drawing

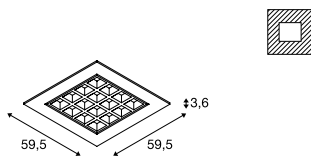

Tip

Open cable end  
Driver not included

Accessory recommendation

□ LED driver 40W | 700mA | 1-10V/  
DALI dimmable | inc. strain relief  
Item No. 1002424



Variant	Item No.
3300lm   3000K   CRI>90	
□ white	1003076
3550lm   4000K   CRI>90	
□ white	1003077

PAVANO  
620x620mm



- Premium LED with CRI>90
- Suitable for screen-based workstations in line with EN 12464-1
- UGR<19

Product details

700mA | 25W  
Material: steel/polycarbonate (PC)  
Installation dimensions: T: 5 cm

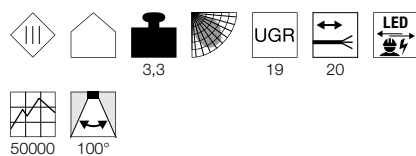

Dimensional drawing

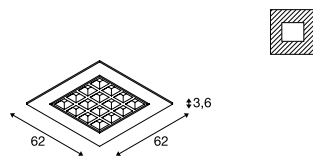

Tip

Open cable end  
Driver not included

Accessory recommendation

□ LED driver 40W | 700mA | 1-10V/  
DALI dimmable | inc. strain relief  
Item No. 1002424



Variant	Item No.
3300lm   3000K   CRI>90	
□ white	1003078
3550lm   4000K   CRI>90	
□ white	1003079

# PROFESSIONAL IMPRESSION.

## 3-CIRCUIT HIGH-VOLTAGE TRACKS FOR NEW LIGHT EMPHASIS.

---

Well thought-out lighting is essential, particularly in locations where there is a lot to see. 3-circuit high-voltage tracks are ideal for shops and trade fair stands. They provide perfect lighting and put products and exhibits in the right light.





1004772 473



1004690 471





1000983 490

HIGH-VOLTAGE 3-PHASE TRACK



	<b>NEW</b> 		<b>NEW VARIANT</b> 				
470	471	472	473	478	478	479	480
							
480	481	481	482	482	483	483	484
							
485	485	485	486	486	487	487	488
<b>FOLLOWER</b> 	<b>FOLLOWER</b> 						
489	489	490	490	491	491	491	492
						<b>NEW VARIANT</b> 	
492	493	493	494	494	495	495	495
<b>NEW</b> 							
496	497	499	499	499			

Suitable recessed and surface mounted tracks and accessories can be found on pages 474-477 and 501-505



 Other luminaires and variants can be found online at [www.slv.com](http://www.slv.com)  
You can find manufacturer's details for our recommended lamps in the chapter 'Lightbulbs', from page 844

# 3-CIRCUIT TRACK COMPATIBILITY

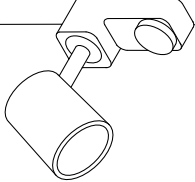
## Compatible with fittings/adapters from:

 Tracks and track components 	Use	SLV	Global/Nordic	Eutrac®
				
without DALI		✓	✓	★
with DALI		✓	✓	✗

## Compatible with tracks and track components from:

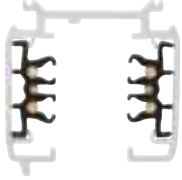
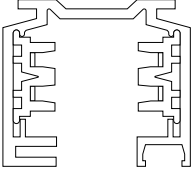
 Fittings and adapters 	Use	SLV S-Track	Global/Nordic	Eutrac®
				
without DALI		✓	✓	✓
with DALI		✓	✓	✓★★

- ★ Subject to prior testing using samples of the lamp and track
- ★★ But without DALI functionality

Details not guaranteed.

Technical data and dimensions are subject to change without notice.

During the planning phase of the project, check the project using samples to ensure functionality.

Compatibility refers only to tracks/fittings. Tracks and track components from different manufacturers should not be combined.

	Staff/Zumtobel	Neuco	Lytespan 3	Mela	Norlux
	★	★	★	★	★
	✗	✗	✗	✗	✗

	Staff/Zumtobel	Neuco	Lytespan 3	Mela	Norlux
	✗	✗	✗	✗	✗
	✗	✗	✗	✗	✗

**STRUCTEC**  
3-circuit, DALI



1003025 470

**LED**  
INSIDE



**DALI**



- Premium LED with CRI>90

**Product details**

200-240V ~50/60Hz | 700mA  
Total wattage: 29W  
Material: aluminium  
Dimmable: Dali

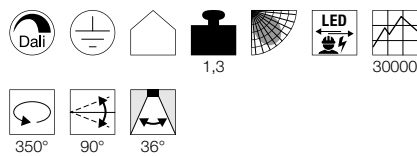

**Dimensional drawing**

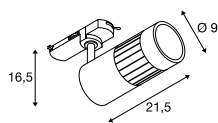

Variant	Item No.
2500lm   3000K   CRI97	
■ matt black	1003024
2500lm   3000K   CRI97	
□ matt white	1003025
2600lm   4000K   CRI97	
■ matt black	1003026
2600lm   4000K   CRI97	
□ matt white	1003027

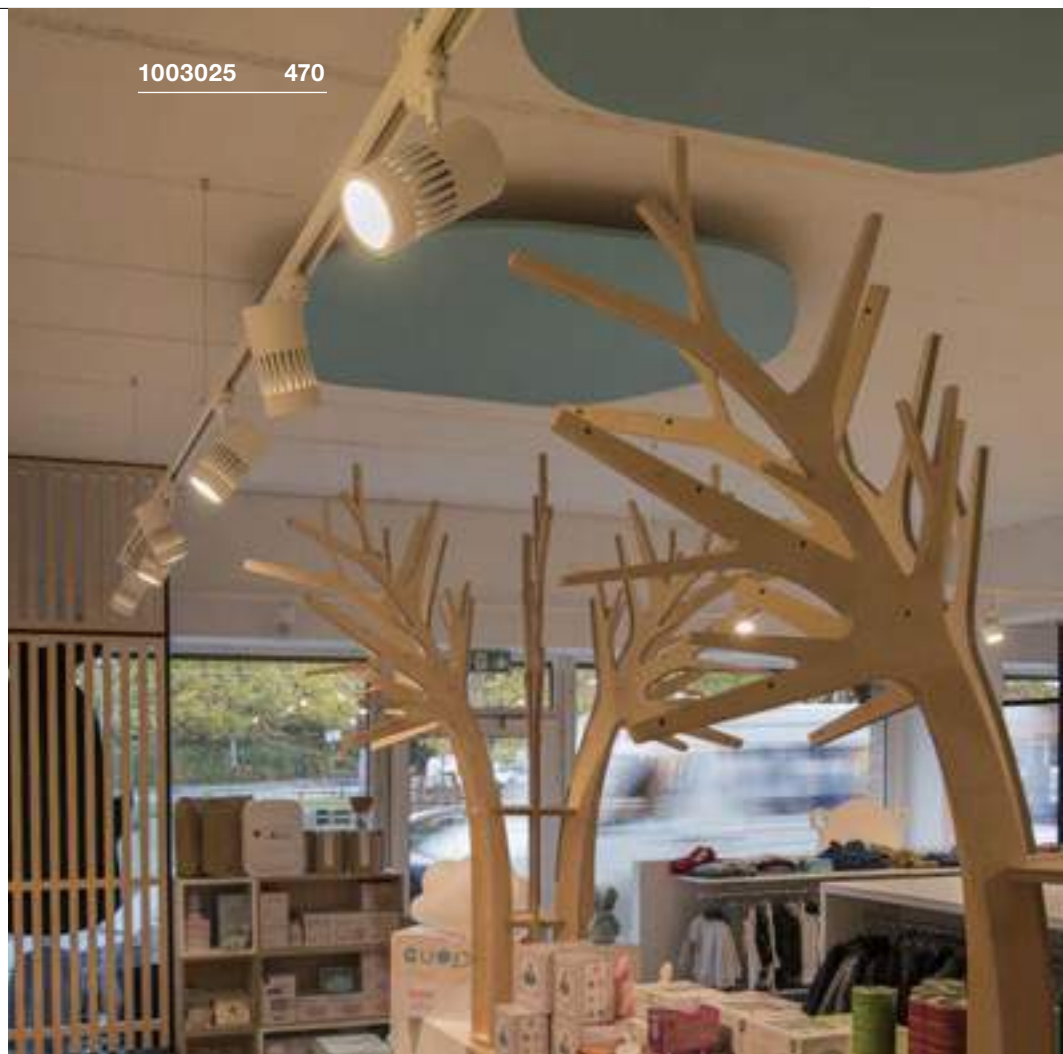



## SIGHT MOVE

3-circuit, DALI



NEW

LED  
INSIDE

DALI



### Product details

220-240V ~50/60Hz | 350mA

Total wattage: 26W

Material: aluminium/PMMA  
(PMMA)

Dimmable: Dali



120°

120°

IP 20

1,24

30000

### Dimensional drawing

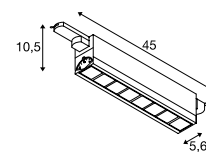

Variant	Item No.
2700lm   3000K   CRI>90 ■ matt black	1004690
2700lm   3000K   CRI>90 □ matt white	1004691
3100lm   4000K   CRI>90 ■ matt black	1004692
3100lm   4000K   CRI>90 □ matt white	1004693

**SIGHT TRACK**  
3-circuit, DALI



1002661 472

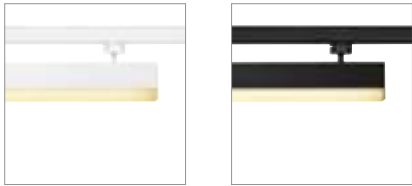

**Product details**

220-240V ~50/60Hz | 700mA  
Total wattage: 40W  
Material: aluminium/acrylic  
Dimmable: Dali

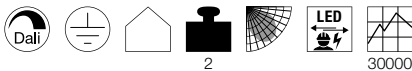

**Dimensional drawing**

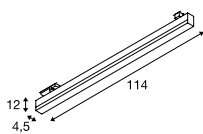

Variant	Item No.
3100lm   3000K   CRI>80	
■ black	1002661
3100lm   3000K   CRI>80	
□ white	1002662

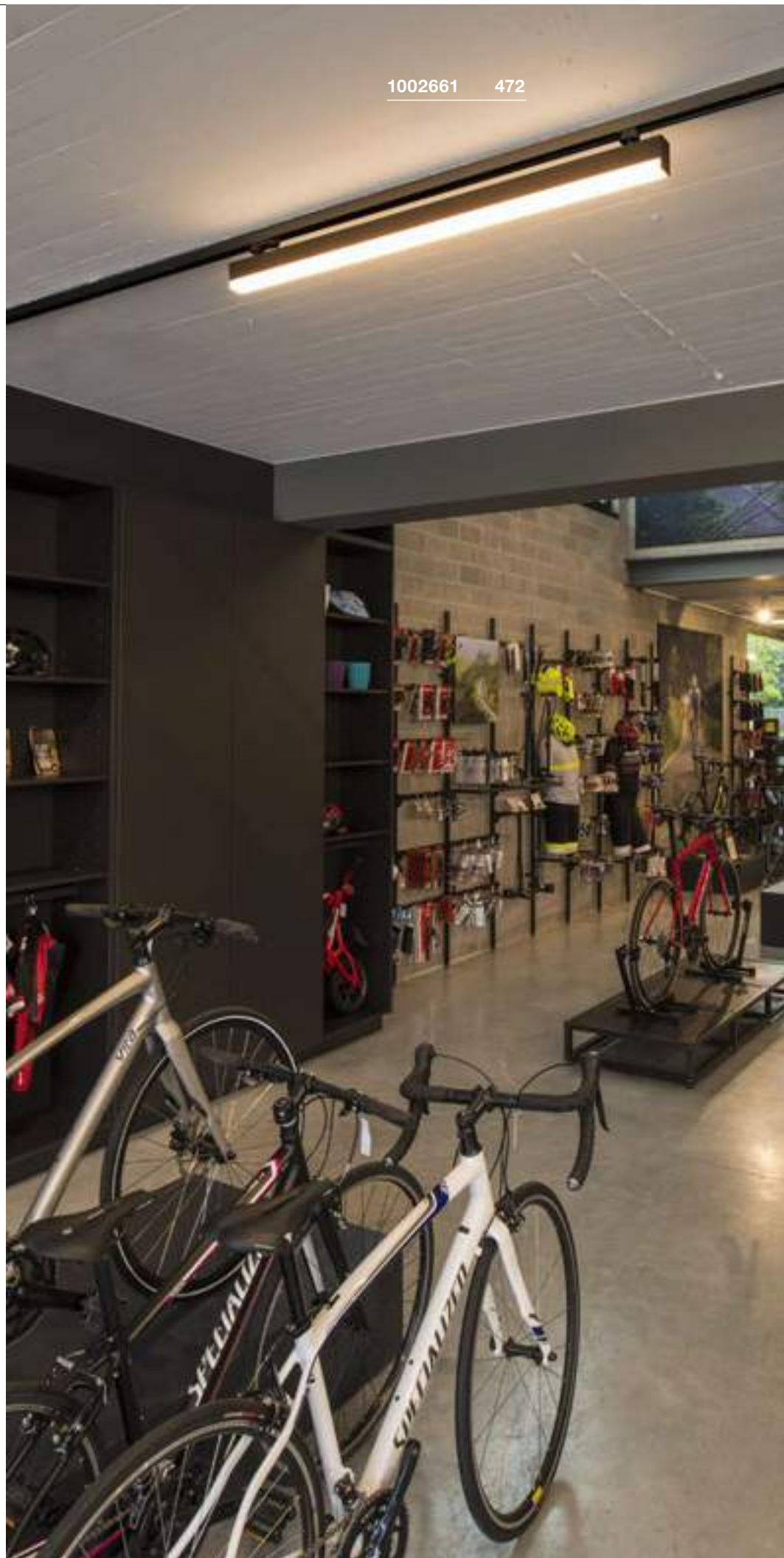





1004771 473

ONE 40 TRACK  
3-circuit, DALI

## Product details

220-240V ~50/60Hz | 350mA  
 Total wattage: 15.2W  
 Material: aluminium  
 Dimmable: Dali



0,75

350°

100°



115°

## Dimensional drawing

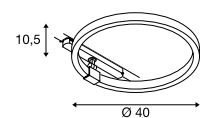

Variant	Item No.
650lm   3000K   CRI90 ■ matt black	1004769
650lm   3000K   CRI90 □ matt white	1004770
670lm   4000K   CRI90 ■ matt black	1004771
670lm   4000K   CRI90 □ matt white	1004772

PLANNING AID FOR S-TRACK 3-CIRCUIT SURFACE MOUNTED TRACK, DALI

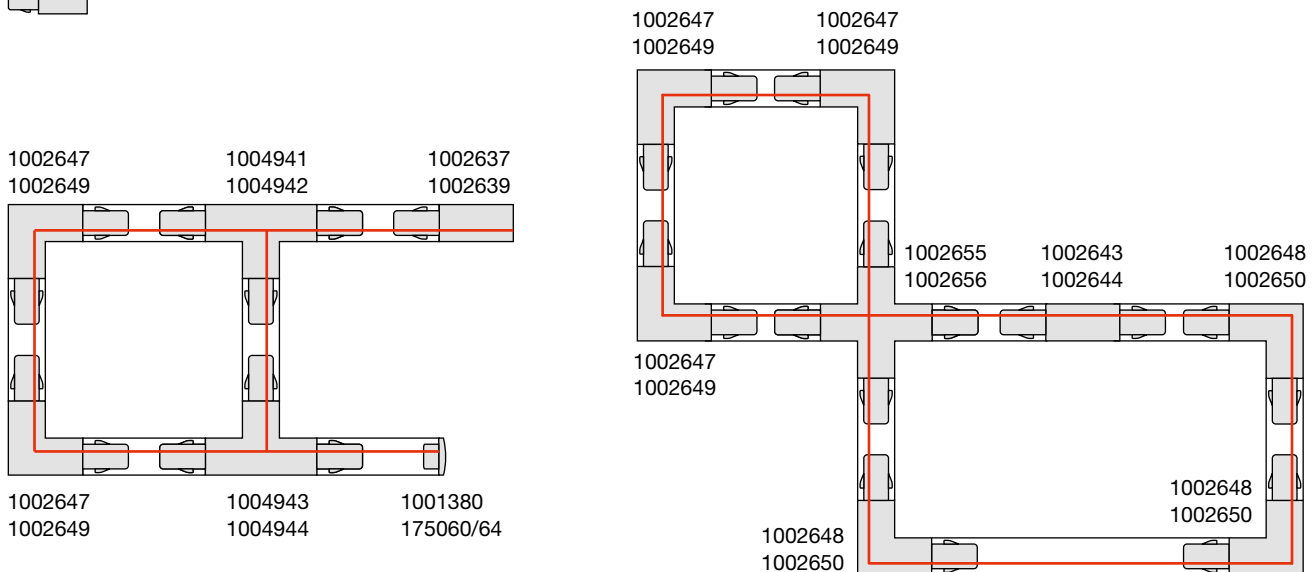
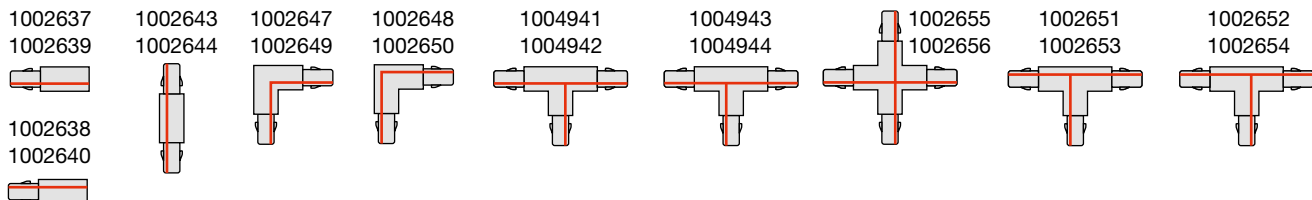
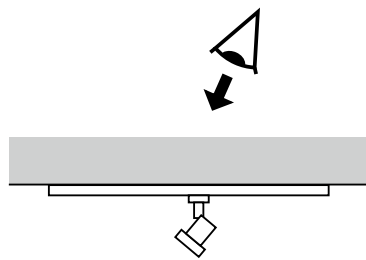



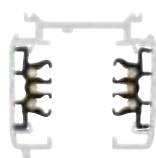

S-TRACK 3-CIRCUIT SURFACE MOUNTED TRACK, DALI



S-TRACK  
3-circuit surface mounted track,  
DALI, 1m



S-TRACK  
3-circuit surface mounted track,  
DALI, 1m

	 	 
Rated voltage	220-250V ~50/60Hz	220-250V ~50/60Hz
Max. perm. current	16A	16A
Mech max. load	300N	300N
Mech max. load	30kg	30kg
Material	aluminium	aluminium
Colour	black	white
Length	100cm	100cm
Width	3.6cm	3.6cm
Height	3.6cm	3.6cm
Weight	0.9kg	0.9kg
<b>Item No.</b>	<b>1004937</b>	<b>1004938</b>





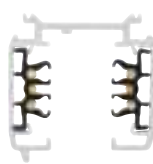

S-TRACK 3-CIRCUIT SURFACE MOUNTED TRACK, DALI



S-TRACK  
3-circuit surface mounted track,  
DALI, 2m



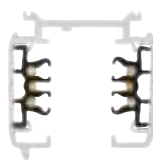

S-TRACK  
3-circuit surface mounted track,  
DALI, 2m

	 	 
Rated voltage	220-250V ~50/60Hz	220-250V ~50/60Hz
Max. perm. current	16A	16A
Mech max. load	300N	300N
Mech max. load	30kg	30kg
Material	aluminium	aluminium
Colour	black	white
Length	200cm	200cm
Width	3.6cm	3.6cm
Height	3.6cm	3.6cm
Weight	1.84kg	1.84kg
<b>Item No.</b>	<b>1002631</b>	<b>1002632</b>



S-TRACK  
3-circuit surface mounted track,  
DALI, 3m



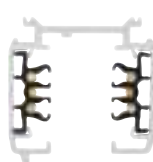

S-TRACK  
3-circuit surface mounted track,  
DALI, 3m

	 	 
Rated voltage	220-250V ~50/60Hz	220-250V ~50/60Hz
Max. perm. current	16A	16A
Mech max. load	300N	300N
Mech max. load	30kg	30kg
Material	aluminium	aluminium
Colour	black	white
Length	300cm	300cm
Width	3.6cm	3.6cm
Height	3.6cm	3.6cm
Weight	2.76kg	2.76kg
<b>Item No.</b>	<b>1002633</b>	<b>1002634</b>



S-TRACK  
3-circuit surface mounted track,  
DALI, 4m

S-TRACK  
3-circuit surface mounted track,  
DALI, 4m

	 	 
Rated voltage	220-250V ~50/60Hz	220-250V ~50/60Hz
Max. perm. current	16A	16A
Mech max. load	300N	300N
Mech max. load	30kg	30kg
Material	aluminium	aluminium
Colour	black	white
Length	400cm	400cm
Width	3.6cm	3.6cm
Height	3.6cm	3.6cm
Weight	3.61kg	3.61kg
<b>Item No.</b>	<b>1002635</b>	<b>1002636</b>



1004772 473

ACCESSORIES FOR S-TRACK 3-CIRCUIT SURFACE MOUNTED TRACK DALI

**Feed-in, DALI, earth on right side**

16A max.  
Polycarbonate (PC)  
L: 13.9cm W: 3.5cm H: 3.3cm  
Weight: 0.06kg  
1 piece



Variant	Item No.
■ black	1002638
□ white	1002640

**Feed-in, DALI, earth on left side**

10A max.  
Polycarbonate (PC)  
L: 13.9cm W: 3.5cm H: 3.3cm  
Weight: 0.06kg  
1 piece



Variant	Item No.
■ black	1002637
□ white	1002639

**Mini-connector, DALI**

16A max.  
Polycarbonate (PC)  
L: 10.6cm W: 2.5cm H: 2.8cm  
Weight: 0.04kg  
1 piece



Variant	Item No.
■ black	1002641
□ white	1002642

**Long connector, DALI**

10A max.  
Polycarbonate (PC)  
L: 20.3cm W: 3.5cm H: 3.3cm  
Weight: 0.13kg  
1 piece



Variant	Item No.
■ black	1002643
□ white	1002644

**Flex connector, DALI**

16A max.  
Polycarbonate (PC)  
L: 28.5cm W: 3.5cm H: 3.3cm  
Weight: 0.18kg  
1 piece



Variant	Item No.
■ black	1002645
□ white	1002646

















**L-connector: DALI, earth on inside**

16A max.  
Polycarbonate (PC)  
L: 11.9cm W: 11.9cm H: 3.3cm  
Weight: 0.13kg  
1 piece



Variant	Item No.
■ black	1002647
□ white	1002649

## ACCESSORIES FOR S-TRACK 3-CIRCUIT SURFACE MOUNTED TRACK DALI

<p><b>L-connector, DALI, earth outside</b></p> <p>16A max. Polycarbonate (PC) L: 11.9cm W: 11.9cm H: 3.3cm Weight: 0.13kg 1 piece</p> 	<p><b>Mounting clip, DALI</b></p> <p>Steel L: 4cm W: 3.4cm H: 1.25cm Weight: 0.02kg 1 piece</p> 	<p><b>Light adaptor, mechanical</b></p> <p>Aluminium/plastic L: 6.6cm W: 6.6cm H: 3.1cm Weight: 0.14kg 1 piece</p> 																		
<table border="1"> <thead> <tr> <th>Variant</th> <th>Item No.</th> </tr> </thead> <tbody> <tr> <td>■ black</td> <td>1002648</td> </tr> <tr> <td>□ white</td> <td>1002650</td> </tr> </tbody> </table>	Variant	Item No.	■ black	1002648	□ white	1002650	<table border="1"> <thead> <tr> <th>Variant</th> <th>Item No.</th> </tr> </thead> <tbody> <tr> <td>■ black</td> <td>1002657</td> </tr> <tr> <td>□ white</td> <td>1002658</td> </tr> </tbody> </table>	Variant	Item No.	■ black	1002657	□ white	1002658	<table border="1"> <thead> <tr> <th>Variant</th> <th>Item No.</th> </tr> </thead> <tbody> <tr> <td>■ black</td> <td>175210</td> </tr> <tr> <td>□ white</td> <td>1001395</td> </tr> </tbody> </table>	Variant	Item No.	■ black	175210	□ white	1001395
Variant	Item No.																			
■ black	1002648																			
□ white	1002650																			
Variant	Item No.																			
■ black	1002657																			
□ white	1002658																			
Variant	Item No.																			
■ black	175210																			
□ white	1001395																			
<p><b>T-connector, DALI, earth on outside, left</b></p> <p>16A max. Polycarbonate (PC) L: 20.3cm W: 11.9cm H: 3.3cm Weight: 0.2kg 1 piece</p> 	<p><b>Adapter, DALI</b></p> <p>10A max. Polycarbonate (PC) L: 11.3cm W: 5.5cm H: 3.3cm Weight: 0.062kg max. 5kg 1 piece</p> 	<p><b>Mini Connector, mechanical</b></p> <p>Plastic L: 6.8cm W: 3.1cm H: 2.6cm Weight: 0.02kg 1 piece</p> 																		
<table border="1"> <thead> <tr> <th>Variant</th> <th>Item No.</th> </tr> </thead> <tbody> <tr> <td>■ black</td> <td>1002651</td> </tr> <tr> <td>□ white</td> <td>1002653</td> </tr> </tbody> </table>	Variant	Item No.	■ black	1002651	□ white	1002653	<table border="1"> <thead> <tr> <th>Variant</th> <th>Item No.</th> </tr> </thead> <tbody> <tr> <td>■ black</td> <td>1002660</td> </tr> <tr> <td>□ white</td> <td>1002659</td> </tr> </tbody> </table>	Variant	Item No.	■ black	1002660	□ white	1002659	<table border="1"> <thead> <tr> <th>Variant</th> <th>Item No.</th> </tr> </thead> <tbody> <tr> <td>■ black</td> <td>175080</td> </tr> <tr> <td>□ white</td> <td>1001382</td> </tr> </tbody> </table>	Variant	Item No.	■ black	175080	□ white	1001382
Variant	Item No.																			
■ black	1002651																			
□ white	1002653																			
Variant	Item No.																			
■ black	1002660																			
□ white	1002659																			
Variant	Item No.																			
■ black	175080																			
□ white	1001382																			
<p><b>T-connector, DALI, earth on outside, right</b></p> <p>16A max. Polycarbonate (PC) L: 20.3cm W: 11.9cm H: 3.3cm Weight: 0.2kg 1 piece</p> 	<p><b>Ceiling suspension</b></p> <p>Stainless steel/brass L: 500cm Weight: 0.2kg max. 10kg 2 piece</p> 	<p><b>Coupling joint connector</b></p> <p>Aluminium L: 18.2cm W: 3.3cm H: 2.1cm Weight: 0.08kg 1 piece</p> 																		
<table border="1"> <thead> <tr> <th>Variant</th> <th>Item No.</th> </tr> </thead> <tbody> <tr> <td>■ black</td> <td>1002652</td> </tr> <tr> <td>□ white</td> <td>1002654</td> </tr> </tbody> </table>	Variant	Item No.	■ black	1002652	□ white	1002654	<table border="1"> <thead> <tr> <th>Variant</th> <th>Item No.</th> </tr> </thead> <tbody> <tr> <td>■ Nickel</td> <td>1002845</td> </tr> </tbody> </table>	Variant	Item No.	■ Nickel	1002845	<table border="1"> <thead> <tr> <th>Variant</th> <th>Item No.</th> </tr> </thead> <tbody> <tr> <td>■ black</td> <td>175180</td> </tr> <tr> <td>□ white</td> <td>1001392</td> </tr> </tbody> </table>	Variant	Item No.	■ black	175180	□ white	1001392		
Variant	Item No.																			
■ black	1002652																			
□ white	1002654																			
Variant	Item No.																			
■ Nickel	1002845																			
Variant	Item No.																			
■ black	175180																			
□ white	1001392																			
<p><b>T-connector II, DALI, earth on inside, left</b></p> <p>16A max. Polycarbonate (PC) L: 20.3cm W: 11.9cm H: 3.3cm Weight: 0.2kg</p> 	<p><b>Adaptor with hook</b></p> <p>Plastic/steel Diameter: 2.6cm H: 5.2cm Weight: 0.01kg Max. 10kg. 1 piece</p> 	<p><b>Cover, DALI, 2m</b></p> <p>Polycarbonate (PC) L: 200cm W: 2.2cm H: 0.75cm Weight: 0.08kg</p> 																		
<table border="1"> <thead> <tr> <th>Variant</th> <th>Item No.</th> </tr> </thead> <tbody> <tr> <td>■ matt black</td> <td>1004943</td> </tr> <tr> <td>□ matt white</td> <td>1004944</td> </tr> </tbody> </table>	Variant	Item No.	■ matt black	1004943	□ matt white	1004944	<table border="1"> <thead> <tr> <th>Variant</th> <th>Item No.</th> </tr> </thead> <tbody> <tr> <td>■ black</td> <td>175190</td> </tr> <tr> <td>□ white</td> <td>1001393</td> </tr> </tbody> </table>	Variant	Item No.	■ black	175190	□ white	1001393	<table border="1"> <thead> <tr> <th>Variant</th> <th>Item No.</th> </tr> </thead> <tbody> <tr> <td>■ matt black</td> <td>1004939</td> </tr> <tr> <td>□ matt white</td> <td>1004940</td> </tr> </tbody> </table>	Variant	Item No.	■ matt black	1004939	□ matt white	1004940
Variant	Item No.																			
■ matt black	1004943																			
□ matt white	1004944																			
Variant	Item No.																			
■ black	175190																			
□ white	1001393																			
Variant	Item No.																			
■ matt black	1004939																			
□ matt white	1004940																			
<p><b>T-connector II, DALI, earth on inside, right</b></p> <p>16A max. Polycarbonate (PC) L: 20.3cm W: 11.9cm H: 3.3cm Weight: 0.2kg</p> 	<p><b>Pendant suspension</b></p> <p>Aluminium/plastic L: 100cm W: 6cm H: 4cm Weight: 0.2kg max. 10kg 1 piece</p> 	<p><b>Ceiling plate, DALI</b></p> <p>16A max. Polycarbonate (PC) Diameter: 14.32cm H: 3.56cm Weight: 0.174kg Ceiling plate for fittings with integrated 3-circuit high-voltage track adapter 1 piece</p> 																		
<table border="1"> <thead> <tr> <th>Variant</th> <th>Item No.</th> </tr> </thead> <tbody> <tr> <td>■ matt black</td> <td>1004941</td> </tr> <tr> <td>□ matt white</td> <td>1004942</td> </tr> </tbody> </table>	Variant	Item No.	■ matt black	1004941	□ matt white	1004942	<table border="1"> <thead> <tr> <th>Variant</th> <th>Item No.</th> </tr> </thead> <tbody> <tr> <td>■ black</td> <td>175160</td> </tr> <tr> <td>□ white</td> <td>1001390</td> </tr> </tbody> </table>	Variant	Item No.	■ black	175160	□ white	1001390	<table border="1"> <thead> <tr> <th>Variant</th> <th>Item No.</th> </tr> </thead> <tbody> <tr> <td>■ black</td> <td>1004684</td> </tr> <tr> <td>□ white</td> <td>1004685</td> </tr> </tbody> </table>	Variant	Item No.	■ black	1004684	□ white	1004685
Variant	Item No.																			
■ matt black	1004941																			
□ matt white	1004942																			
Variant	Item No.																			
■ black	175160																			
□ white	1001390																			
Variant	Item No.																			
■ black	1004684																			
□ white	1004685																			
<p><b>X-connector, DALI</b></p> <p>16A max. Polycarbonate (PC) L: 20.3cm W: 20.3cm H: 3.3cm Weight: 0.27kg 1 piece</p> 	<p><b>End cap</b></p> <p>Plastic L: 3.5cm W: 3.3cm H: 3.2cm Weight: 0.01kg 1 piece</p> 																			
<table border="1"> <thead> <tr> <th>Variant</th> <th>Item No.</th> </tr> </thead> <tbody> <tr> <td>■ black</td> <td>1002655</td> </tr> <tr> <td>□ white</td> <td>1002656</td> </tr> </tbody> </table>	Variant	Item No.	■ black	1002655	□ white	1002656	<table border="1"> <thead> <tr> <th>Variant</th> <th>Item No.</th> </tr> </thead> <tbody> <tr> <td>■ black</td> <td>175060</td> </tr> <tr> <td>□ white</td> <td>1001380</td> </tr> </tbody> </table>	Variant	Item No.	■ black	175060	□ white	1001380							
Variant	Item No.																			
■ black	1002655																			
□ white	1002656																			
Variant	Item No.																			
■ black	175060																			
□ white	1001380																			

**SPOT TRACK**  
3-circuit, E27



SOCKET  
INSIDE



• stable joint

**Product details**

230V -50Hz  
Material: aluminium

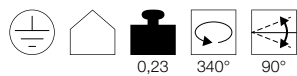

0,23 340° 90°

**Dimensional drawing**

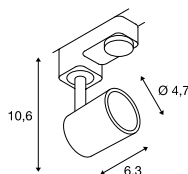

**Recommended lamp**

LED E27 7W 180°  
2700K 630lm  
8kWh/1000h  
Item No. 1001357



LED E27 17W 45°  
3000K 1430lm  
17kWh/1000h  
Item No. 560473



**Lamp details**

max. 75W QPAR20  
optional: QPAR30

Variant	Item No.
E27   QPAR20	
■ black	152200
E27   QPAR20	
□ white	152201

**AVO TRACK**  
3-circuit, QPAR51



SOCKET  
INSIDE



**Product details**

230V ~50/60Hz  
Material: steel



0,2 350° 90°

**Dimensional drawing**

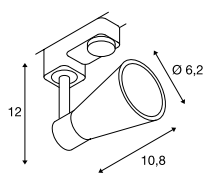

**Recommended lamp**

LED GU10 6W 36°  
3000K 460lm  
6kWh/1000h  
Item No. 1005078



LED GU10 6W 36°  
4000K 460lm  
6kWh/1000h  
Item No. 1005081



**Lamp details**

max. 50W QPAR51  
Diameter: 5cm max.

Variant	Item No.
GU10   QPAR51	
■ black	152640
GU10   QPAR51	
□ white	152641



152201

478



152640

478



152320 479

## ALTRA DICE TRACK

3-circuit, QPAR51



SOCKET  
INSIDE



### Product details

220-240V ~50/60Hz  
Material: aluminium



0,4 350° 180°

### Dimensional drawing

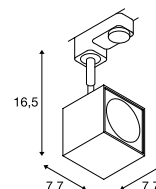

### Recommended lamp

LED GU10 6W 36°  
3000K 460lm  
6kWh/1000h  
Item No. 1005080



LED GU10 6W 36°  
4000K 460lm  
6kWh/1000h  
Item No. 1005083



### Lamp details

max. 50W QPAR51  
Diameter: 5cm max. L.: 5.7cm max.

Variant	Item No.
GU10   QPAR51	
■ black	152320
GU10   QPAR51	
□ white	152321

**LIGHT EYE® 150 TRACK**  
3-circuit, QPAR111



SOCKET  
INSIDE



**PARA CONE 14**  
3-circuit, QPAR111



SOCKET  
INSIDE



**Product details**

230V -50Hz  
Material: steel

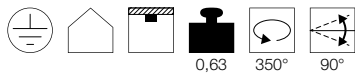

0,63 350° 90°

**Dimensional drawing**

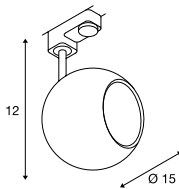

**Product details**

220-240V ~50/60Hz  
Material: steel



0,4 300° 80°

**Dimensional drawing**

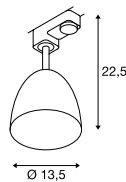

**Recommended lamp**

LED GU10 13W 55°  
2700K 840lm  
13kWh/1000h  
Item No. 1003094



LED GU10 13W 55°  
4000K 950lm  
13kWh/1000h  
Item No. 1003095



**Lamp details**

max. 75W QPAR111

Variant	Item No.
GU10   QPAR111	
■ black/chrome	1000707
GU10   QPAR111	
■ white/chrome	1000708

**Recommended lamp**

LED GU10 5,1W 48°  
2700-6500K 350lm  
6kWh/1000h  
Item No. 1001918



LED GU10 4W  
2600K 260lm  
4kWh/1000h  
Item No. 1003101



**Lamp details**

max. 25W QPAR51

Variant	Item No.
GU10   QPAR111	
■ glossy black	1002876
GU10   QPAR111	
□ glossy white	1002877
GU10   QPAR111	
■ copper	1002878

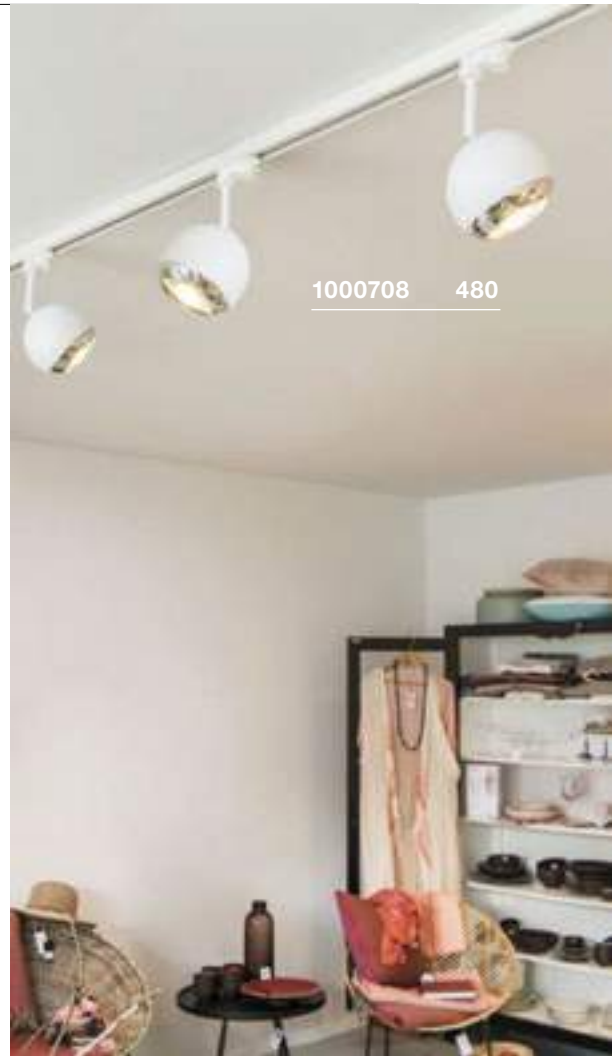

1000708 480



1002878 480



1001471 481



**LENITO TRACK**  
3-circuit



- High efficiency
- Wide, homogeneous lighting

**Product details**

220-240V ~50/60Hz | 160mA  
Total wattage: 23W  
Material: aluminium/polycarbonate (PC)

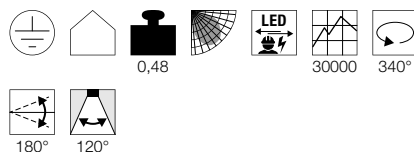

**Dimensional drawing**

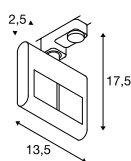

**MERADO FLOOD TRACK**  
3-circuit, PHASE



- Asymmetrical light distribution
- For homogeneous lighting

**Product details**

220-240V ~50/60Hz | 1000mA  
Total wattage: 40W  
Material: aluminium/plastic  
Dimmable: C, L

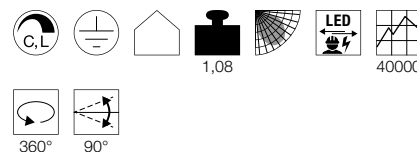

**Dimensional drawing**

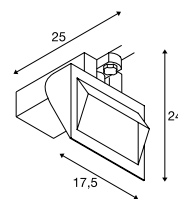

1001475 481

Variant	Item No.
2450lm   3000K   CRI>80	
■ black	<b>1001467</b>
250lm · 3000K · CRI>80	
□ white	<b>1001466</b>

Variant	Item No.
3000lm   3000K   CRI>80	
■ black	<b>1001471</b>
3000lm   3000K   CRI>80	
□ white	<b>1001470</b>
3200lm   4000K   CRI>80	
■ black	<b>1001475</b>
3200lm   4000K   CRI>80	
□ white	<b>1001474</b>

HELIA 50 TRACK  
3-circuit



NOBLO SPOT  
3-circuit



• Premium LED with CRI>90

Product details

220-240V ~50/60Hz | 500mA  
Total wattage: 11W  
Material: aluminium

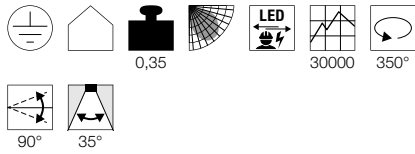

Dimensional drawing

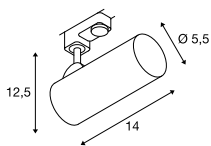

Product details

220-240V ~50/60Hz | 350mA  
Total wattage: 7.5W  
Material: aluminium

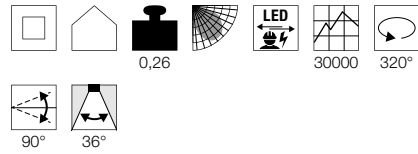

Dimensional drawing

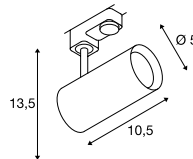

Variant	Item No.
750lm   3000K   CRI>90	
■ black	<b>152960</b>
750lm   3000K   CRI>90	
□ white	<b>152961</b>

Variant	Item No.
620lm   2700K   CRI>80	
■ black	<b>1001865</b>
620lm   2700K   CRI>80	
□ white	<b>1001866</b>
620lm   2700K   CRI>80	
■ grey	<b>1001867</b>





152420 483



1001292 483

**ENOLA C TRACK**  
3-circuit

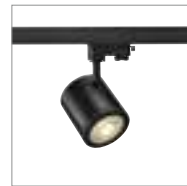

**Product details**

220-240V ~50/60Hz | 500mA  
Total wattage: 12W  
Material: aluminium

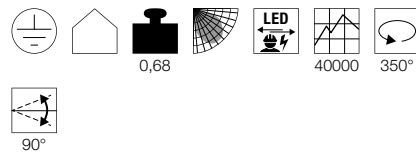

**Dimensional drawing**

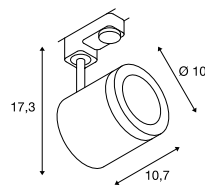

Variant	Item No.
900lm   3000K   CRI>80   35°	
■ black	<b>152420</b>
900lm   3000K   CRI>80   35°	
□ white	<b>152421</b>
900lm   3000K   CRI>80   55°	
■ black	<b>152430</b>
900lm   3000K   CRI>80   55°	
□ white	<b>152431</b>

**SIGHT TRACK**  
3-circuit



**Product details**

220-240V ~50/60Hz | 700mA  
Total wattage: 37W  
Material: aluminium/acrylic

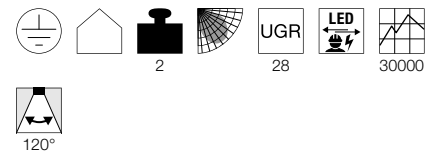

**Dimensional drawing**

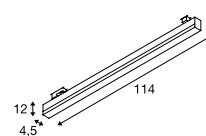

Variant	Item No.
3100lm   3000K   CRI>80	
■ black	<b>1001289</b>
3100lm   3000K   CRI>80	
□ white	<b>1001290</b>
3100lm   3000K   CRI>80	
■ grey	<b>1001292</b>

PURI  
3-circuit, QPAR51



SOCKET  
INSIDE



Product details

220-240V ~50/60Hz  
Material: aluminium/polycarbonate (PC)



Dimensional drawing

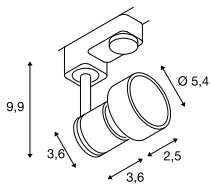

Note

Decorative ring for QPAR51 inc.

Recommended lamp

LED GU10 6W 36°  
4000K 460lm  
6kWh/1000h  
Item No. 1005081



Lamp details

max. 50W QPAR51  
Diameter: 11cm max. L: 7.8cm max.  
optional: QPAR111

Variant	Item No.
GU10   QPAR51	
■ black	153560
GU10   QPAR51	
□ white	153561
GU10   QPAR51	
■ grey	153564

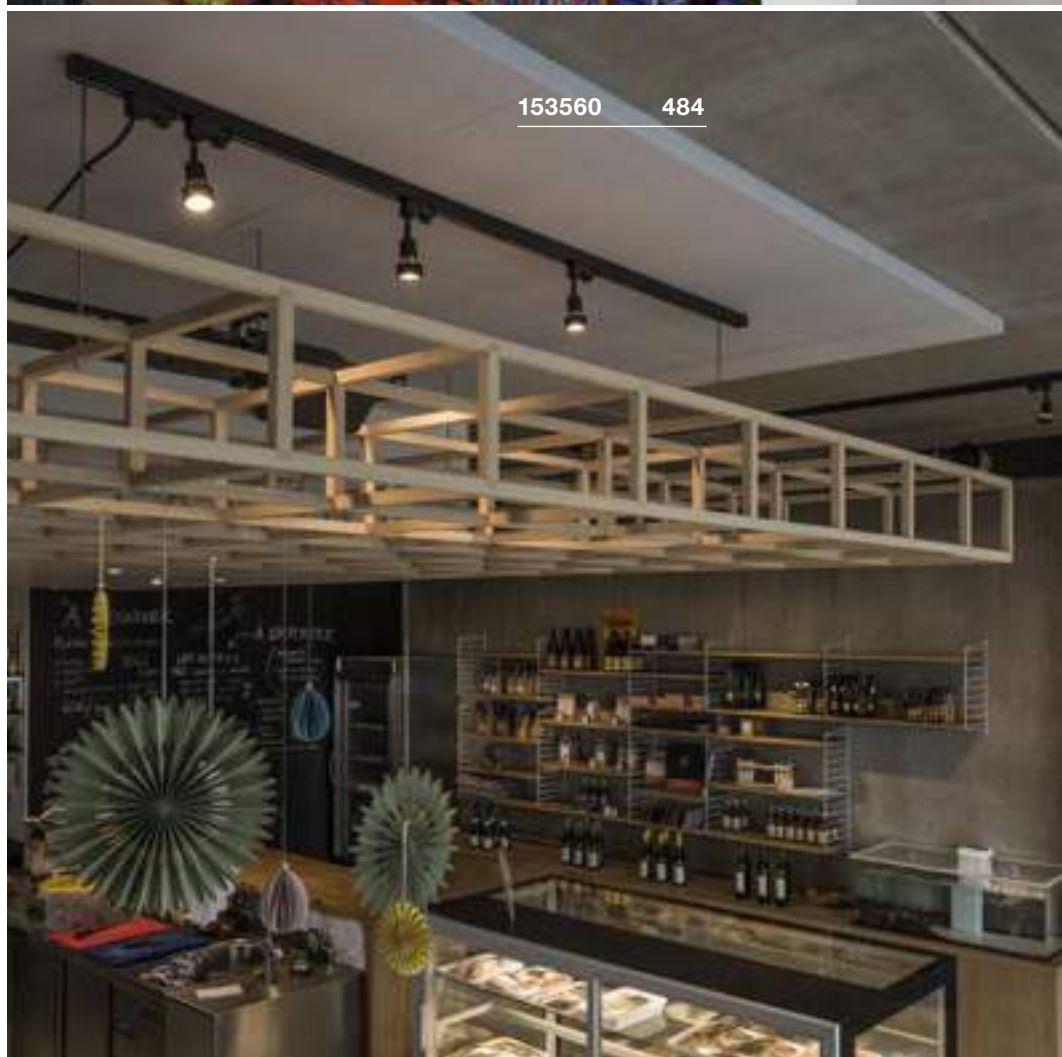
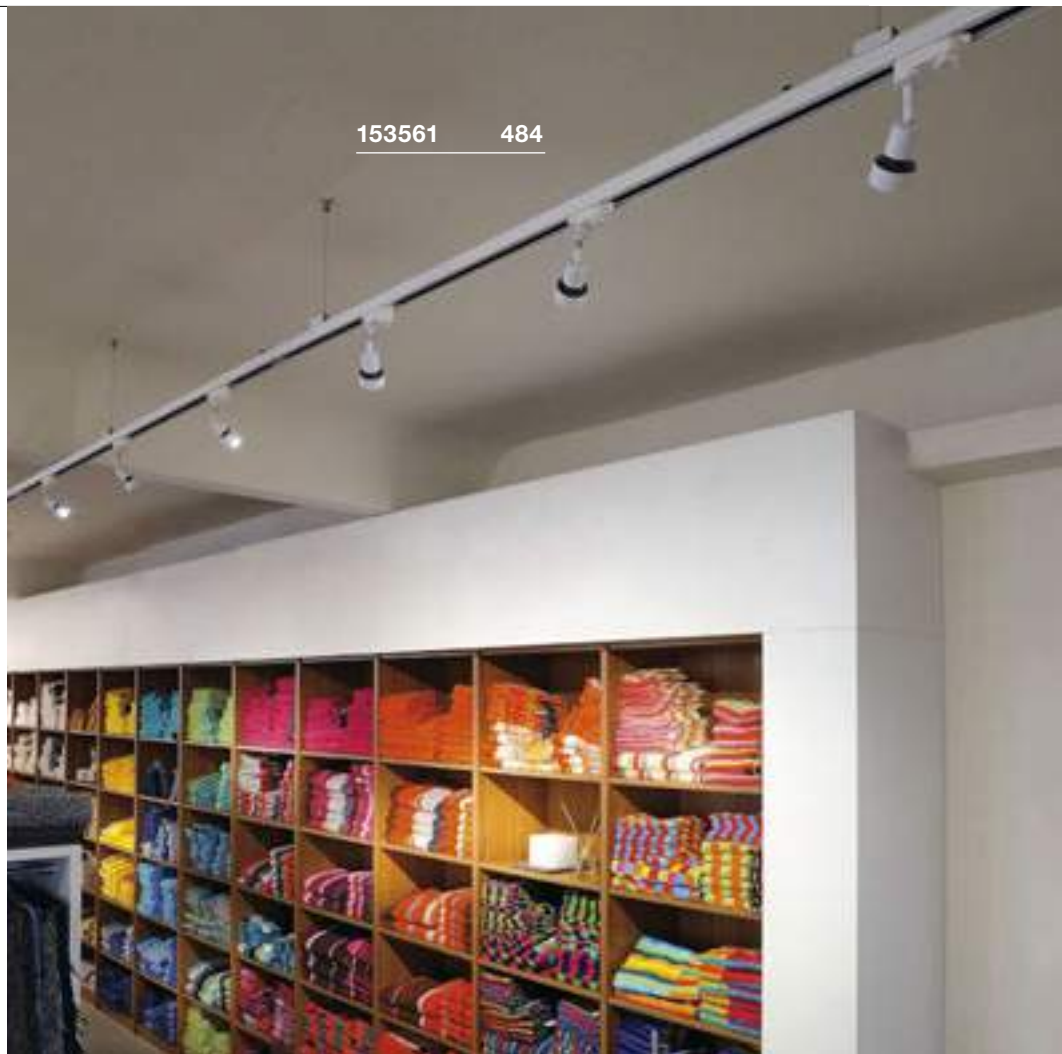

**PURI TRACK**  
3-circuit, QPAR51



SOCKET  
INSIDE



**BIMA**  
3-circuit, single, QPAR51



SOCKET  
INSIDE



**BIMA**  
3-circuit, double, QPAR51



SOCKET  
INSIDE

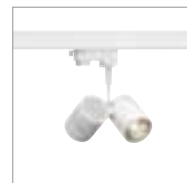

• The lamp heads can be swivelled in opposite directions

**Product details**

230V ~50Hz  
Material: aluminium/plastic



0,3 340° 85°

**Dimensional drawing**

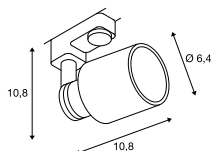

**Product details**

220-240V ~50/60Hz  
Material: aluminium



0,35 350° 200°

**Dimensional drawing**

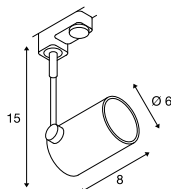

**Product details**

220-240V ~50/60Hz  
Material: aluminium



0,41 350° 200°

**Dimensional drawing**

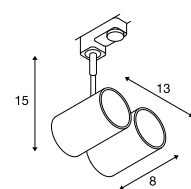

**Recommended lamp**

LED GU10 5.5W 38°  
2700K 400lm  
6kWh/1000h  
Item No. 1001030



LED GU10 6W 36°  
3000K 460lm  
6kWh/1000h  
Item No. 1005079



**Lamp details**

max. 10W QPAR51

Variant	Item No.
GU10   QPAR51	
■ black	1001871
GU10   QPAR51	
□ white	1001872

**Recommended lamp**

LED GU10 5.5W 38°  
2700K 400lm  
6kWh/1000h  
Item No. 1001030



LED GU10 6W 36°  
3000K 460lm  
6kWh/1000h  
Item No. 1005079



**Lamp details**

max. 50W QPAR51  
Diameter: 5cm max. L: 5.7cm max.

Variant	Item No.
GU10   QPAR51	
■ black	152240
GU10   QPAR51	
□ white	152241
GU10   QPAR51	
■ grey	152242

**Recommended lamp**

LED GU10 6W 36°  
4000K 460lm  
6kWh/1000h  
Item No. 1005081



LED GU10 6W 36°  
2700K 460lm  
6kWh/1000h  
Item No. 1005077



**Lamp details**

2x max. 50W QPAR51  
Diameter: 5cm max. L: 5.7cm max.

Variant	Item No.
GU10   QPAR51	
■ black	152230
GU10   QPAR51	
□ white	152231
GU10   QPAR51	
■ grey	152232

**TEC KALU TRACK**  
3-circuit, double, PHASE



**TEC KALU TRACK**  
3-circuit, quad, PHASE



**Product details**

220-240V ~50/60Hz | 700mA  
Total wattage: 31W  
Material: aluminium/polycarbonate (PC)  
Dimmable: C

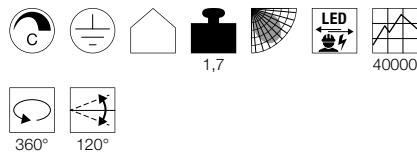

**Dimensional drawing**

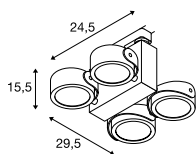

**Product details**

220-240V ~50/60Hz | 700mA  
Total wattage: 60W  
Material: aluminium/polycarbonate (PC)  
Dimmable: C

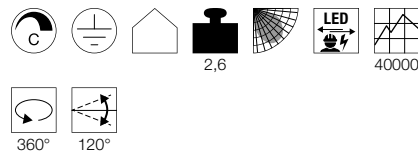

**Dimensional drawing**

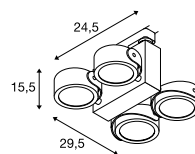

1001421 486



1001420 486

Variant	Item No.
1900lm   3000K   CRI>80   24° ■ black	<b>1001427</b>
1900lm   3000K   CRI>80   24° ▨ white/black	<b>1001428</b>
1900lm   3000K   CRI>80   60° ■ black	<b>1001419</b>
1900lm   3000K   CRI>80   60° ▨ white/black	<b>1001420</b>

Variant	Item No.
3800lm   3000K   CRI>80   24° ■ black	<b>1001429</b>
3800lm   3000K   CRI>80   24° ▨ white/black	<b>1001430</b>
3800lm   3000K   CRI>80   60° ■ black	<b>1001421</b>
3800lm   3000K   CRI>80   60° ▨ white/black	<b>1001422</b>



152780 487



152781 487

**EURO CUBE**  
3-circuit



**Product details**

220-240V ~50/60Hz  
Total wattage: 28.5W  
Material: aluminium

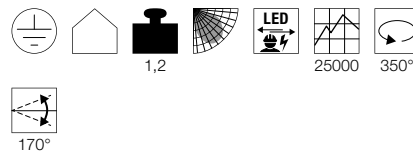

**Dimensional drawing**

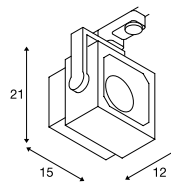

**EURO CUBE**  
3-circuit



**Product details**

220-240V ~50/60Hz  
Total wattage: 28.5W  
Material: aluminium

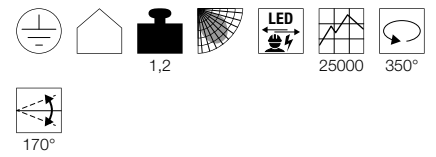

**Dimensional drawing**

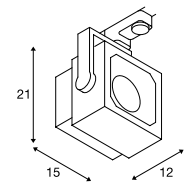

Variant	Item No.
2100lm   3000K   CRI>90   60°	
■ black	<b>152750</b>
2100lm   3000K   CRI>90   60°	
□ white	<b>152751</b>
2100lm   3000K   CRI>90   60°	
■ grey	<b>152754</b>
1950lm   3000K   CRI>90   90°	
■ black	<b>152760</b>
1950lm   3000K   CRI>90   90°	
□ white	<b>152761</b>
1950lm   3000K   CRI>90   90°	
■ grey	<b>152764</b>

Variant	Item No.
2150lm   4000K   CRI>90   60°	
■ black	<b>152780</b>
2150lm   4000K   CRI>90   60°	
□ white	<b>152781</b>
2150lm   4000K   CRI>90   60°	
■ grey	<b>152784</b>
2050lm   4000K   CRI>90   90°	
■ black	<b>152790</b>
2050lm   4000K   CRI>90   90°	
□ white	<b>152791</b>
2050lm   4000K   CRI>90   90°	
■ grey	<b>152794</b>

**SUPROS 78 TRACK**  
3-circuit, PHASE



152661 488



**Product details**

220-240V ~50/60Hz | 250mA  
Total wattage: 12W  
Material: aluminium  
Dimmable: C, L

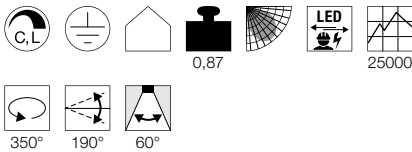

**Dimensional drawing**

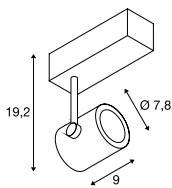

**Recommended accessories**

- Lens 20°  
Item No. 116302
- Lens 40°  
Item No. 116304
- Diffusor  
Item No. 1000677
- Diffusor  
Item No. 1000678

Variant	Item No.
700lm   3000K   CRI>80   60°	
■ black	152660
700lm   3000K   CRI>80   60°	
□ white	152661







1003292 489



1003295 489

**SUPROS TRACK**  
3-circuit



**SUPROS TRACK**  
3-circuit



**Product details**

220-240V ~50/60Hz | 750mA  
Total wattage: 31W  
Material: aluminium

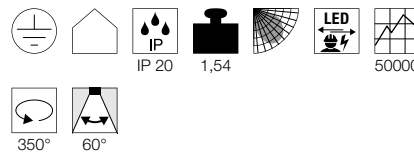

**Product details**

220-240V ~50/60Hz | 950mA  
Total wattage: 36W  
Material: aluminium/glass

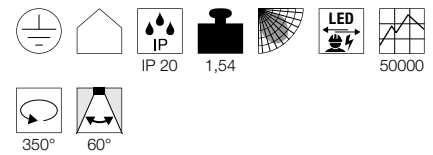

**Dimensional drawing**

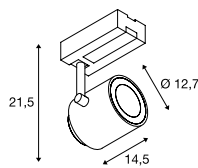

**Note**

Other colour temperatures available upon request

**Dimensional drawing**

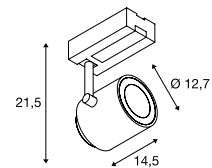

**Note**

Other colour temperatures available upon request

**Recommended accessories**

- Reflector 20°  
Item No. 114102
- Reflector 40°  
Item No. 114104

**Recommended accessories**

- Reflector 20°  
Item No. 114102
- Reflector 40°  
Item No. 114104

Variant	Item No.
2600lm   3000K   CRI>90   60°	
■ black	1003291
2600lm   3000K   CRI>90   60°	
□ white	1003292
2700lm   4000K   CRI>90   60°	
■ black	1003293
2700lm   4000K   CRI>90   60°	
□ white	1003294

Variant	Item No.
3380lm   3000K   CRI>90   60°	
■ black	1003295
3380lm   3000K   CRI>90   60°	
□ white	1003296
3520lm   4000K   CRI>90   60°	
■ black	1003297
3520lm   4000K   CRI>90   60°	
□ white	1003298

**STRUCTEC**  
3-circuit



**STRUCTEC**  
3-circuit



**Product details**

220-240V ~50/60Hz  
Total wattage: 28W  
Material: aluminium

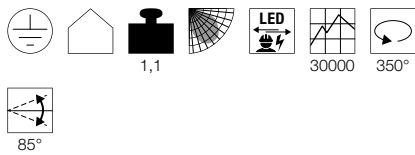

**Dimensional drawing**

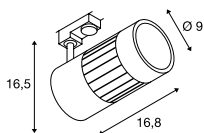

**Product details**

220-240V ~50/60Hz  
Total wattage: 28W  
Material: aluminium

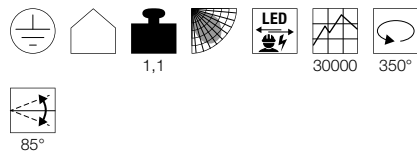

**Dimensional drawing**

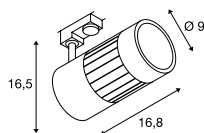

Variant	Item No.
2700lm   3000K   CRI>90   36° ■ matt black	<b>1000980</b>
2700lm   3000K   CRI>90   36° □ matt white	<b>1000981</b>
2650lm   3000K   CRI>90   60° ■ matt black	<b>1000983</b>
2650lm   3000K   CRI>90   60° □ matt white	<b>1000984</b>

Variant	Item No.
2800lm   4000K   CRI>90   36° ■ matt black	<b>1000986</b>
2800lm   4000K   CRI>90   36° □ matt white	<b>1000987</b>
2750lm   4000K   CRI>90   60° ■ matt black	<b>1000989</b>
2750lm   4000K   CRI>90   60° □ matt white	<b>1000990</b>



**1000980 490**



**1001002 491**

**STRUCTEC**  
3-circuit

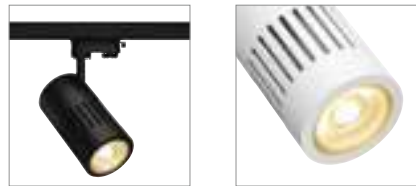

**Product details**

220-240V ~50/60Hz  
Total wattage: 35W  
Material: aluminium

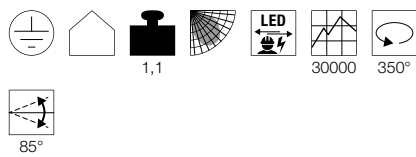

**Dimensional drawing**

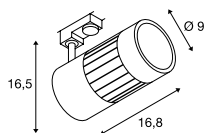

Variant	Item No.
3200lm   3000K   CRI>90   36°	
■ matt black	<b>1000992</b>
3200lm   3000K   CRI>90   36°	
□ matt white	<b>1000993</b>
3150lm   3000K   CRI>90   60°	
■ matt black	<b>1000995</b>
3150lm   3000K   CRI>90   60°	
□ matt white	<b>1000996</b>

**STRUCTEC**  
3-circuit



**Product details**

220-240V ~50/60Hz  
Total wattage: 35W  
Material: aluminium

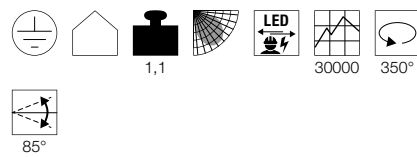

**Dimensional drawing**

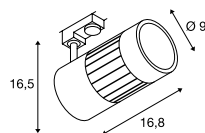

Variant	Item No.
3450lm   4000K   CRI>90   36°	
■ matt black	<b>1000998</b>
3450lm   4000K   CRI>90   36°	
□ matt white	<b>1000999</b>
3400lm   4000K   CRI>90   60°	
■ matt black	<b>1001001</b>
3400lm   4000K   CRI>90   60°	
□ matt white	<b>1001002</b>

**STRUCTEC ZOOM**  
3-circuit



- Adjustable from 25° to 60°
- Modern lighting solution for various lighting concepts

**Product details**

220-240V ~50/60Hz  
Total wattage: 35W  
Material: aluminium

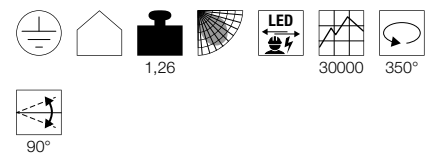

**Dimensional drawing**

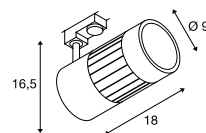

Variant	Item No.
3000lm   3000K   CRI>90	
■ matt black	<b>1000656</b>
3000lm   3000K   CRI>90	
□ matt white	<b>1000657</b>
3000lm   3000K   CRI>90	
■ matt grey	<b>1000658</b>

**KALU TRACK**  
3-circuit, QPAR111



SOCKET  
INSIDE



**Product details**

230V -50Hz  
Material: aluminium/plastic



**Dimensional drawing**

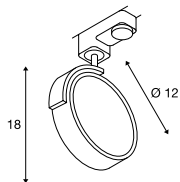

**Recommended lamp**

LED GU10 13W 30°  
2700K 1100lm  
13kWh/1000h  
Item No. 1001242



LED GU10 13W 30°  
4000K 1100lm  
13kWh/1000h  
Item No. 1003087



**Lamp details**

max. 75W QPAR111

Variant	Item No.
GU10   QPAR111	
■ black	152610
GU10   QPAR111	
□ white	152611
GU10   QPAR111	
■ grey	152614

**KALU TRACK**  
3-circuit, QR111



SOCKET  
INSIDE



**Product details**

230V ~50Hz | 12V AC  
Material: aluminium/plastic



**Dimensional drawing**

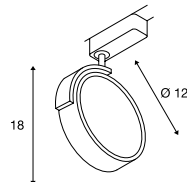

**Recommended lamp**

LED G53 15W 40°  
2700K 750lm  
17kWh/1000h  
Item No. 560232



LED G53 15W 40°  
3000K 760lm  
17kWh/1000h  
Item No. 560234



**Lamp details**

max. 50W QR111

Variant	Item No.
G53   QR111	
■ black	153580
G53   QR111	
□ white	153581
G53   QR111	
■ grey	153584



152614 492



153580 492



152601 493

**KALU TRACK**  
3-circuit, PHASE



**Product details**

220-240V ~50/60Hz  
Total wattage: 13W  
Material: aluminium  
Dimmable: C

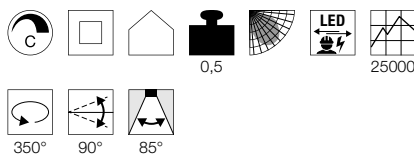

**Dimensional drawing**

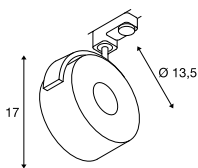

**KALU TRACK**  
3-circuit, PHASE



**Product details**

220-240V ~50/60Hz | 350mA  
Total wattage: 17W  
Material: aluminium/polycarbonate (PC)  
Dimmable: C

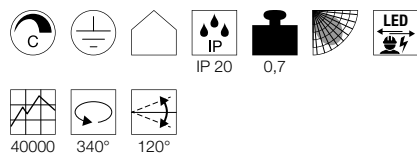

**Dimensional drawing**

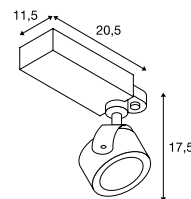

153600 493

Variant	Item No.
860lm   3000K   CRI>80	
■ black	152600
860lm   3000K   CRI>80	
□ white	152601

Variant	Item No.
1000lm   3000K   CRI>80   24°	
■ black	153600
1000lm   3000K   CRI>80   60°	
■ black	1000769

**EURO SPOT TRACK**  
3-circuit, QPAR51



SOCKET  
INSIDE

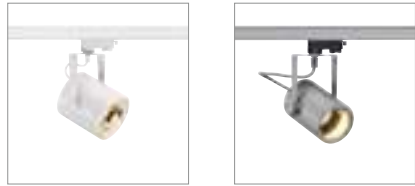

**Product details**

230V -50Hz  
Material: aluminium/glass



**Dimensional drawing**

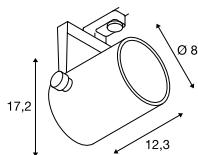

**Recommended lamp**

LED GU10 3,7W 36°  
2700K 260lm  
4kWh/1000h  
Item No. 560122



LED 6W 36°  
2700K 460lm  
6kWh/1000h  
Item No. 1005075



**Lamp details**

max. 25W QPAR51

Variant	Item No.
GU10   QPAR51	
■ black	153850
GU10   QPAR51	
□ white	153851
GU10   QPAR51	
■ grey	153854

**EURO SPOT TRACK**  
3-circuit, QPAR111



SOCKET  
INSIDE



**Product details**

230V -50Hz  
Material: aluminium

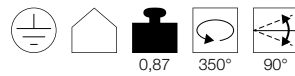

**Dimensional drawing**

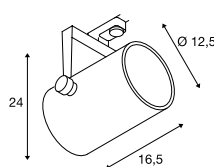

**Recommended lamp**

LED GU10 13W 55°  
4000K 950lm  
13kWh/1000h  
Item No. 1003095



LED GU10 13W 30°  
4000K 1100lm  
13kWh/1000h  
Item No. 1003087



**Lamp details**

max. 75W QPAR111

Variant	Item No.
GU10   QPAR111	
■ black	153420
GU10   QPAR111	
□ white	153421
GU10   QPAR111	
■ grey	153424

153854 494



1002681 495



EURO SPOT TRACK  
3-circuit



Product details

220-240V ~50/60Hz  
Total wattage: 11W  
Material: aluminium

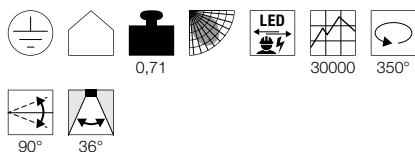

Dimensional drawing

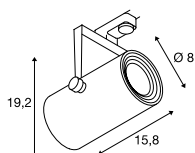

Variant	Item No.
650lm   3000K   CRI>80 ■ black	1001367
650lm   3000K   CRI>80 □ white	1001368
650lm   3000K   CRI>80 ■ grey	1001369

EURO SPOT TRACK  
3-circuit



Product details

220-240V ~50/60Hz | 500mA  
Total wattage: 20W  
Material: aluminium

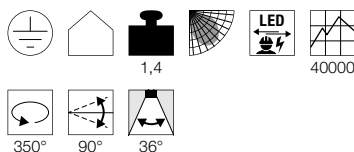

Dimensional drawing

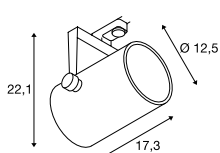

Variant	Item No.
1800lm   3000K   CRI>80 ■ black	1002681
1900lm   3000K   CRI>80 □ white	1002682
1900lm   3000K   CRI>80 ■ grey	1002683

EURO SPOT TRACK  
3-circuit



Product details

220-240V ~50/60Hz | 1500mA  
Total wattage: 61W  
Material: aluminium/glass

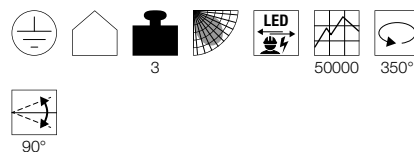

Dimensional drawing

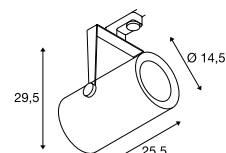

Variant	Item No.
5500lm   3000K   CRI>80   12° ■ black	1001476
5500lm   3000K   CRI>80   12° □ white	1001477
5500lm   3000K   CRI>80   12° ■ grey	1001478
5500lm   3000K   CRI>80   38° ■ black	1001484
5500lm   3000K   CRI>80   38° □ white	1001480
5500lm   3000K   CRI>80   38° ■ grey	1001479
5500lm   3000K   CRI>80   60° ■ black	1001481
5500lm   3000K   CRI>80   60° □ white	1001482
5500lm   3000K   CRI>80   60° ■ grey	1001483

SIGHT MOVE  
3-circuit



NEW



LED  
INSIDE



1004686 496

Product details

220-240V ~50/60Hz | 350mA  
Total wattage: 26W  
Material: aluminium/PMMA



Dimensional drawing

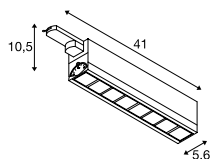

Variant	Item No.
2700lm   3000K   CRI>90 ■ matt black	1004686
2700lm   3000K   CRI>90 □ matt white	1004687
3100lm   4000K   CRI>90 ■ matt black	1004688
3100lm   4000K   CRI>90 □ matt white	1004689







1002048 497

SIGHT TRACK  
3-circuit, PDLED  
INSIDE

## Product details

220-240V ~50/60Hz | 700mA  
Total wattage: 40W  
Material: aluminium/acrylic



120°

## Dimensional drawing

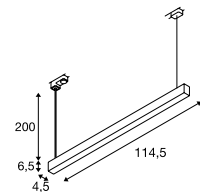

Variant	Item No.
3100lm   3000K   CRI>80 ■ black	1002048
3100lm   3000K   CRI>80 □ white	1002049
3100lm   3000K   CRI>80 ■ grey	1002050



153141 499

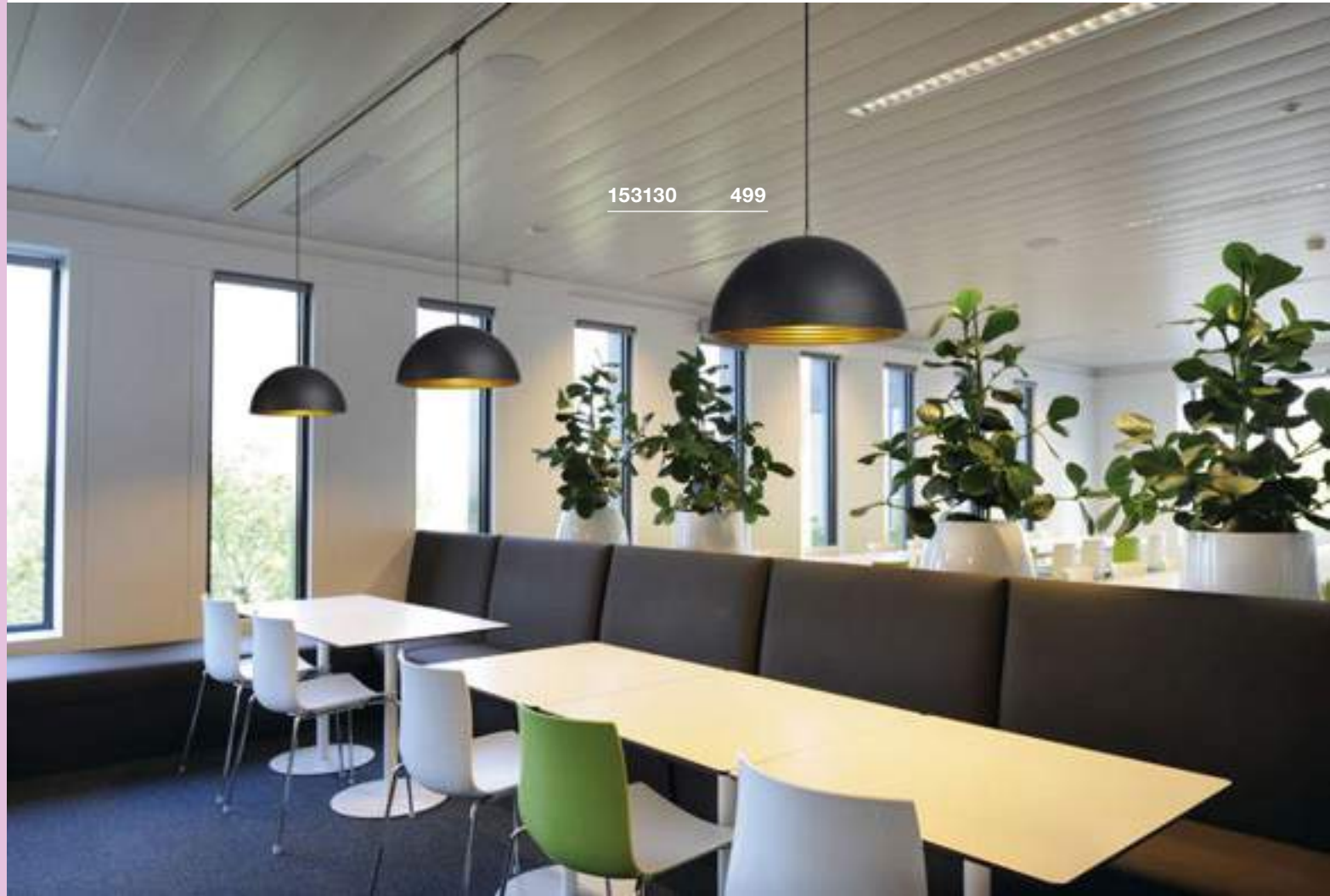

153130 499

**LIGHT EYE® 150**  
3-circuit, PD, QPAR111



SOCKET  
INSIDE



**Product details**

230V -50Hz  
Material: steel



**Dimensional drawing**

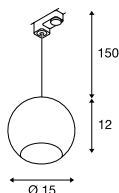

**Recommended lamp**

LED GU10 13W 55°  
2700K 840lm  
13kWh/1000h  
Item No. 1003094



LED GU10 9,5W 25°  
2200-6700K 800lm  
10kWh/1000h  
Item No. 1001922



**Lamp details**

max. 75W QPAR111

Variant	Item No.
GU10   QPAR111	
■ black/chrome	1000709
GU10   QPAR111	
■ white/chrome	1000710
GU10   QPAR111	
■ chrome	153112

**PARA CONE 14**  
3-circuit, PD, QPAR51



SOCKET  
INSIDE



**Product details**

220-240V ~50/60Hz  
Material: aluminium



**Dimensional drawing**

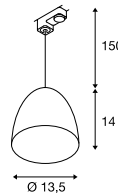

**Recommended lamp**

LED GU10 5,1W 48°  
2700-6500K 350lm  
6kWh/1000h  
Item No. 1001918



LED GU10 4W  
2600K 260lm  
4kWh/1000h  
Item No. 1003101



**Lamp details**

max. 35W QPAR51

Variant	Item No.
GU10   QPAR51	
■ glossy black	153140
GU10   QPAR51	
■ glossy white	153141
GU10   QPAR51	
■ copper	1002686

**FORCHINI M 40 TRACK**  
3-circuit, PD, E27



SOCKET  
INSIDE



**Product details**

230V -50Hz  
Material: aluminium/steel



**Dimensional drawing**

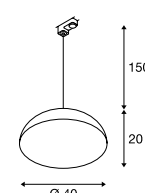

**Recommended lamp**

LED E27 10,5W 360°  
2700K 1000lm  
10,5kWh/1000h  
Item No. 1003093



LED E27 4W 180°  
2000-2900K 200lm  
4kWh/1000h  
Item No. 1003098



**Lamp details**

max. 40W  
L: 15.2 cm max.

Variant	Item No.
E27	
■ black/gold	153130
E27	
■ white/gold	153131

- Double-walled design with interior reflector
- Textile cable in housing colour

PLANNING AID FOR EUTRAC® 3-CIRCUIT SURFACE MOUNTED TRACKS

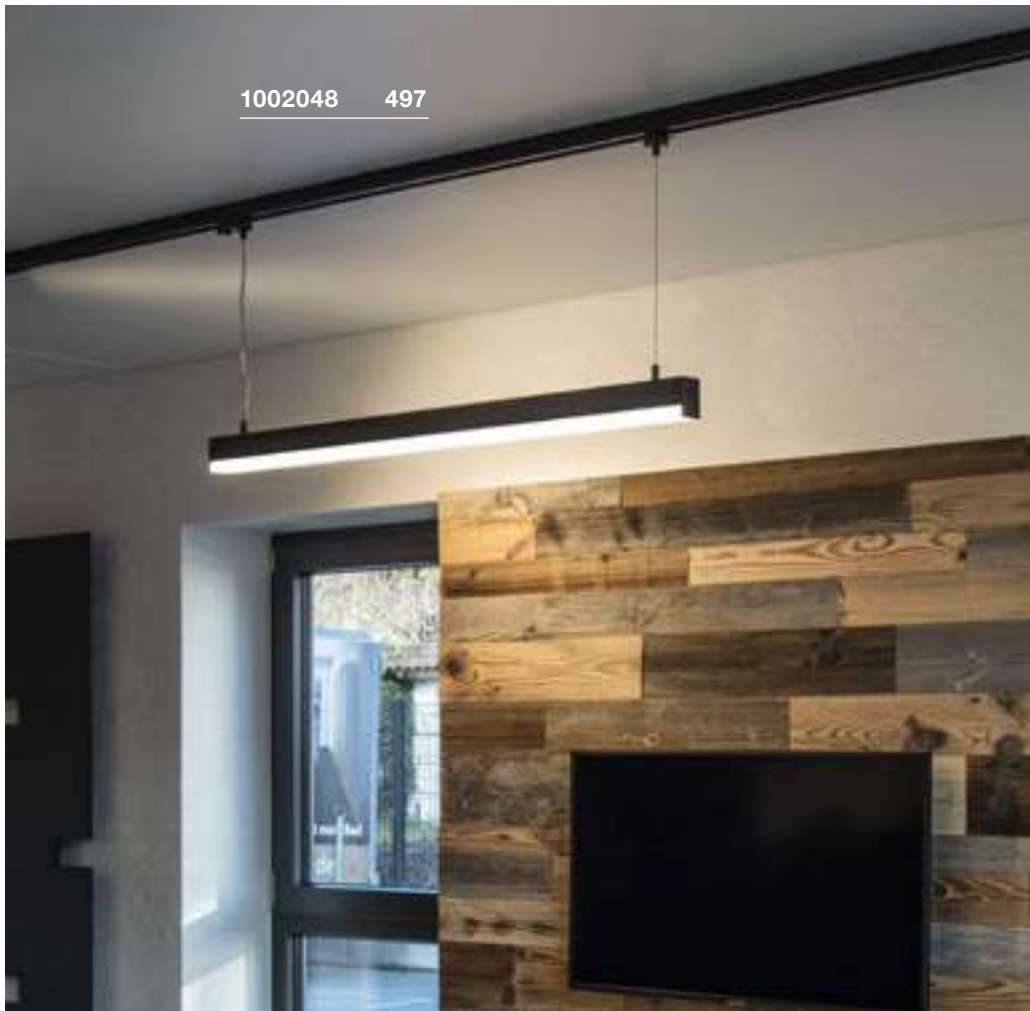
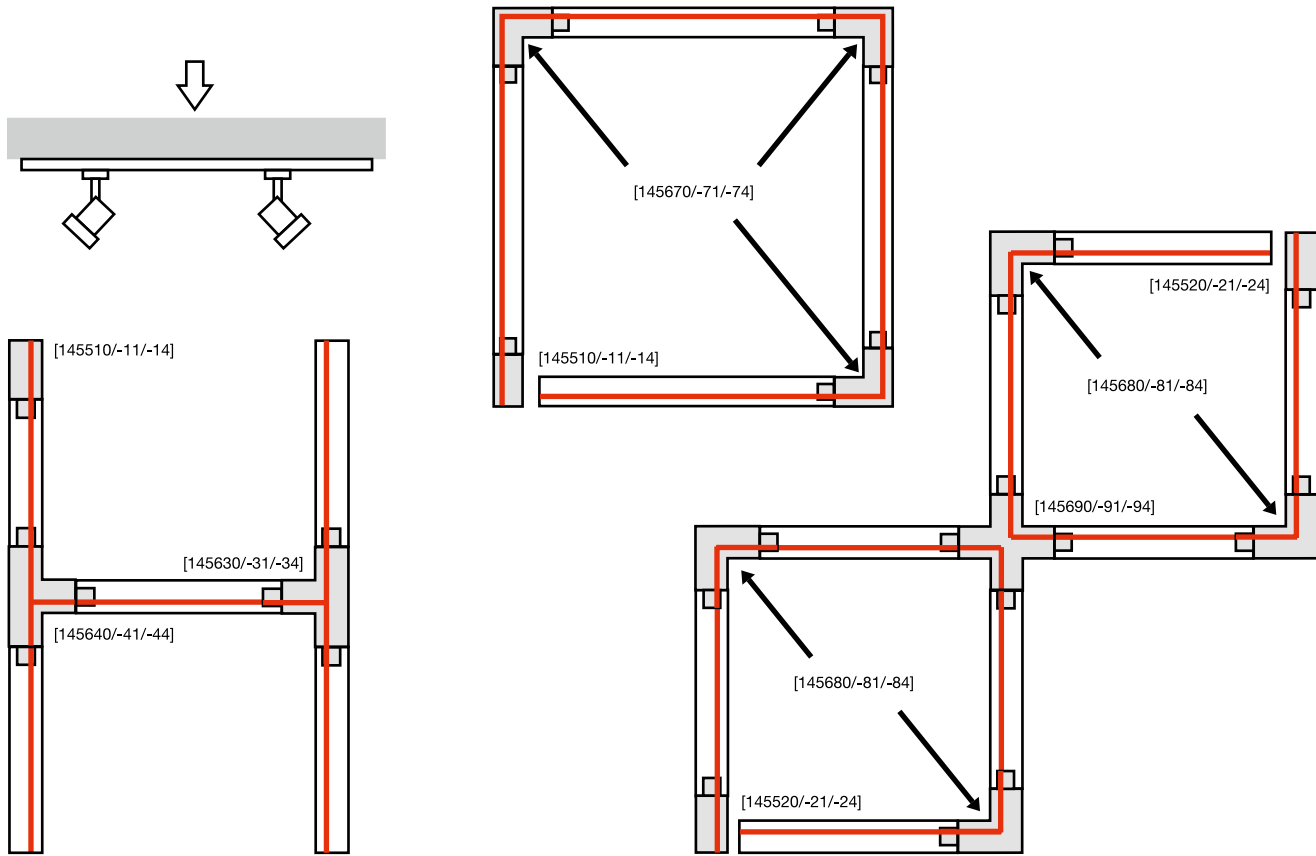

EUTRAC® 3-CIRCUIT SURFACE MOUNTED TRACK

	EUTRAC® 3-circuit surface mounted track, 1m	EUTRAC® 3-circuit surface mounted track, 1m	EUTRAC® 3-circuit surface mounted track, 1m
Rated voltage	230V -50Hz	230V -50Hz	230V -50Hz
Max. perm. current	16A	16A	16A
Material	Aluminium/plastic	Aluminium/plastic	Aluminium/plastic
Colour	black	white RAL 9016	grey
Length	100cm	100cm	100cm
Width	3.6cm	3.6cm	3.6cm
Height	3.2cm	3.2cm	3.2cm
Weight	1kg	1kg	1kg
<b>Item No.</b>	<b>145100</b>	<b>1001510</b>	<b>145102</b>

Manufacturer: Eutrac Stromschienen GmbH

	EUTRAC® 3-circuit surface mounted track, 2m	EUTRAC® 3-circuit surface mounted track, 2m	EUTRAC® 3-circuit surface mounted track, 2m
Rated voltage	230V -50Hz	230V -50Hz	230V -50Hz
Max. perm. current	16A	16A	16A
Material	Aluminium/plastic	Aluminium/plastic	Aluminium/plastic
Colour	black	white RAL 9016	grey
Length	200cm	200cm	200cm
Width	3.6cm	3.6cm	3.6cm
Height	3.2cm	3.2cm	3.2cm
Weight	2kg	2kg	2kg
<b>Item No.</b>	<b>145200</b>	<b>1001511</b>	<b>145202</b>

Manufacturer: Eutrac Stromschienen GmbH

	EUTRAC® 3-circuit surface mounted track, 3m	EUTRAC® 3-circuit surface mounted track, 3m	EUTRAC® 3-circuit surface mounted track, 3m
Rated voltage	230V -50Hz	230V -50Hz	230V -50Hz
Max. perm. current	16A	16A	16A
Material	Aluminium/plastic	Aluminium/plastic	Aluminium/plastic
Colour	black	white RAL 9016	grey
Length	300cm	300cm	300cm
Width	3.6cm	3.6cm	3.6cm
Height	3.2cm	3.2cm	3.2cm
Weight	3kg	3kg	3kg
<b>Item No.</b>	<b>145300</b>	<b>1001512</b>	<b>145302</b>

Manufacturer: Eutrac Stromschienen GmbH



133330

114

133300

115

## ACCESSORIES FOR EUTRAC® 3-CIRCUIT SURFACE MOUNTED TRACK

Manufacturer: Eutrac Stromschienen GmbH

### Feed-in, left

16A max.  
Plastic  
L: 11.2cm W: 3.6cm H: 3.2cm  
Weight: 0.08kg  
Earth on left-hand side.  
1 piece



Variant	Item No.
■ black	145510
□ white	1001513
■ grey	145514

### Longitudinal connector with feed-in capability

16A max.  
Plastic/steel  
L: 26cm W: 3.6cm H: 3.2cm  
Weight: 0.15kg  
1 piece



Variant	Item No.
■ black	145660
□ white	1001517
■ grey	145664

### Feed-in, right

16A max.  
Plastic  
L: 11.2cm W: 3.6cm H: 3.2cm  
Weight: 0.08kg  
Earth on right-hand side.  
1 piece



Variant	Item No.
■ black	145520
□ white	1001514
■ grey	145524

### T-connector, earth on left

16A max.  
Plastic/steel  
L: 26cm W: 18.5cm H: 3.2cm  
Weight: 0.35kg  
1 piece



Variant	Item No.
■ black	145630
□ white	1001518
■ grey	145634

### Centre feed-in

16A max.  
Plastic  
L: 13cm W: 3.6cm H: 3.6cm  
Weight: 0.08kg  
1 piece



Variant	Item No.
■ black	145530
□ white	1001515
■ grey	145534

### T-connector, earth on right

16A max.  
Plastic/steel  
L: 26cm W: 18.5cm H: 3.2cm  
Weight: 0.35kg  
1 piece



Variant	Item No.
■ black	145640
□ white	1001519
■ grey	145644

### Longitudinal connector

16A max.  
Plastic  
L: 5.8cm W: 1.5cm H: 2.6cm  
Weight: 0.03kg  
1 piece



Variant	Item No.
■ black	145560
□ white	1001516
■ grey	145564

### L-connector, earth outside

16A max.  
Plastic/steel  
L: 15cm W: 15cm H: 3.2cm  
Weight: 0.24kg  
1 piece



Variant	Item No.
■ black	145670
□ white	1001520
■ grey	145674

1001292 483

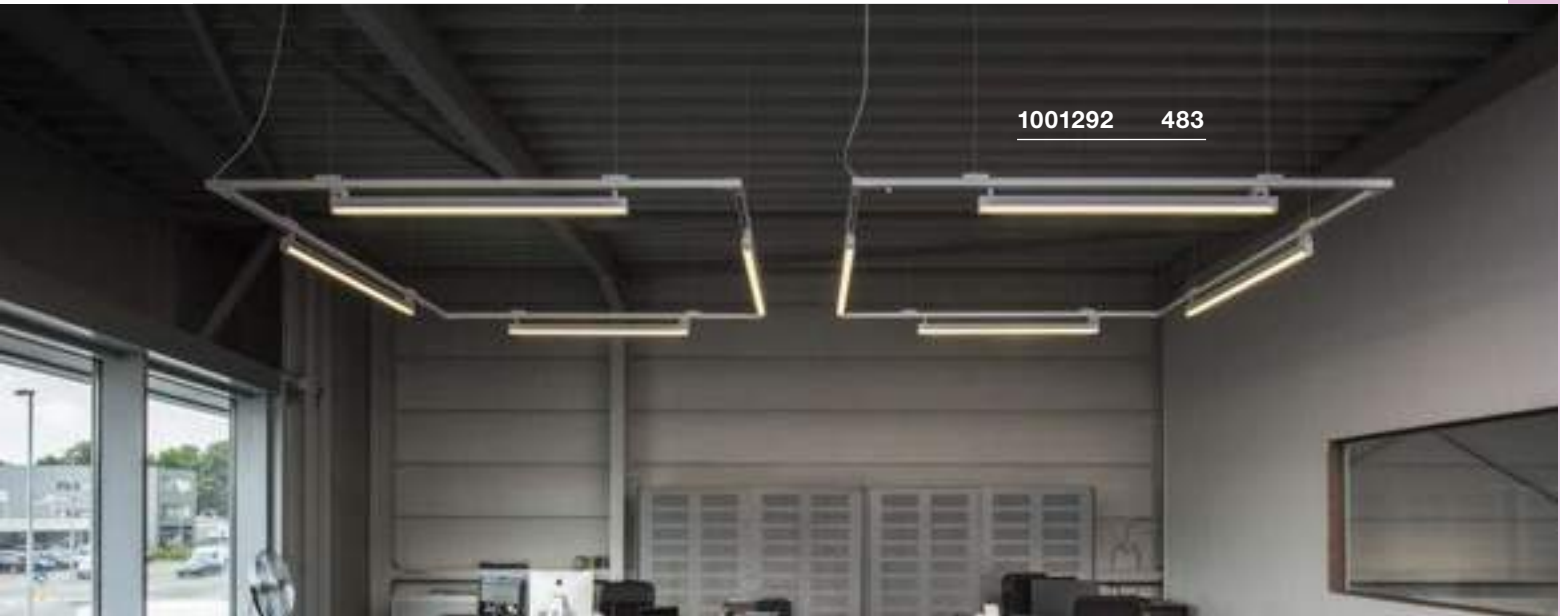

## ACCESSORIES FOR EUTRAC® 3-CIRCUIT SURFACE MOUNTED TRACK Manufacturer: Eutrac Stromschienen GmbH

### L-connector, earth inside

16A max.  
Plastic/steel  
L: 15cm W: 15cm H: 3.2cm  
Weight: 0.24kg  
1 piece



Variant	Item No.
■ black	145680
□ white	1001521
■ grey	145684

### Socket

6.3A max.  
Plastic  
L: 9.6cm W: 6.5cm H: 9cm  
Weight: 0.17kg  
1 piece



Variant	Item No.
■ black	145700
□ white	1001525

### Pendant suspension, rigid

Plastic/steel  
Diameter: 7cm L: 120cm H: 122cm  
Weight: 0.49kg  
1 piece



Variant	Item No.
■ black	145710
□ white	1001528
■ grey	145714

### X-connector

16A max.  
Plastic/steel  
L: 26cm W: 26cm H: 3.2cm  
Weight: 0.27kg  
2 separate power circuits  
1 piece



Variant	Item No.
■ black	145690
□ white	1001522
■ grey	145694

### Universal point outlet

16A max.  
Plastic  
Diameter: 11.9cm H: 3.1cm  
1 piece



Variant	Item No.
■ black	145830
□ white	1001526
■ grey	145834

### Pendant suspension, rigid

Plastic/steel  
Diameter: 7cm L: 60cm H: 63.5cm  
Weight: 0.28kg  
1 piece



Variant	Item No.
■ black	145720
□ white	1001529
■ grey	145724

### Joint connector

Plastic  
L: 10cm W: 3.6cm H: 1.9cm  
Weight: 0.06kg  
1 piece



Variant	Item No.
■ black	145600
□ white	1001523
■ grey	145604

### End cap

Plastic  
L: 3.6cm W: 1.7cm H: 3.2cm  
Weight: 0.01kg  
1 piece



Variant	Item No.
■ black	145590
□ white	1001527
■ grey	145594

### Pendant clip

aluminium  
L: 5cm W: 3.6cm H: 1.9cm  
Weight: 0.04kg  
1 piece



Variant	Item No.
■ black	145730
□ white	1001530
■ grey	145734

### Flex connector

16A max.  
Plastic/steel  
L: 22cm W: 3.6cm H: 3.2cm  
Weight: 0.23kg  
1 piece



Variant	Item No.
■ black	145580
□ white	1001524
■ grey	145584

### Ceiling suspension

Stainless steel/brass  
L: 500cm  
Weight: 0.2kg  
2 piece



Variant	Item No.
■ Nickel	1002845

### 3-circuit pendant adapter

10A max.  
Plastic  
1 piece



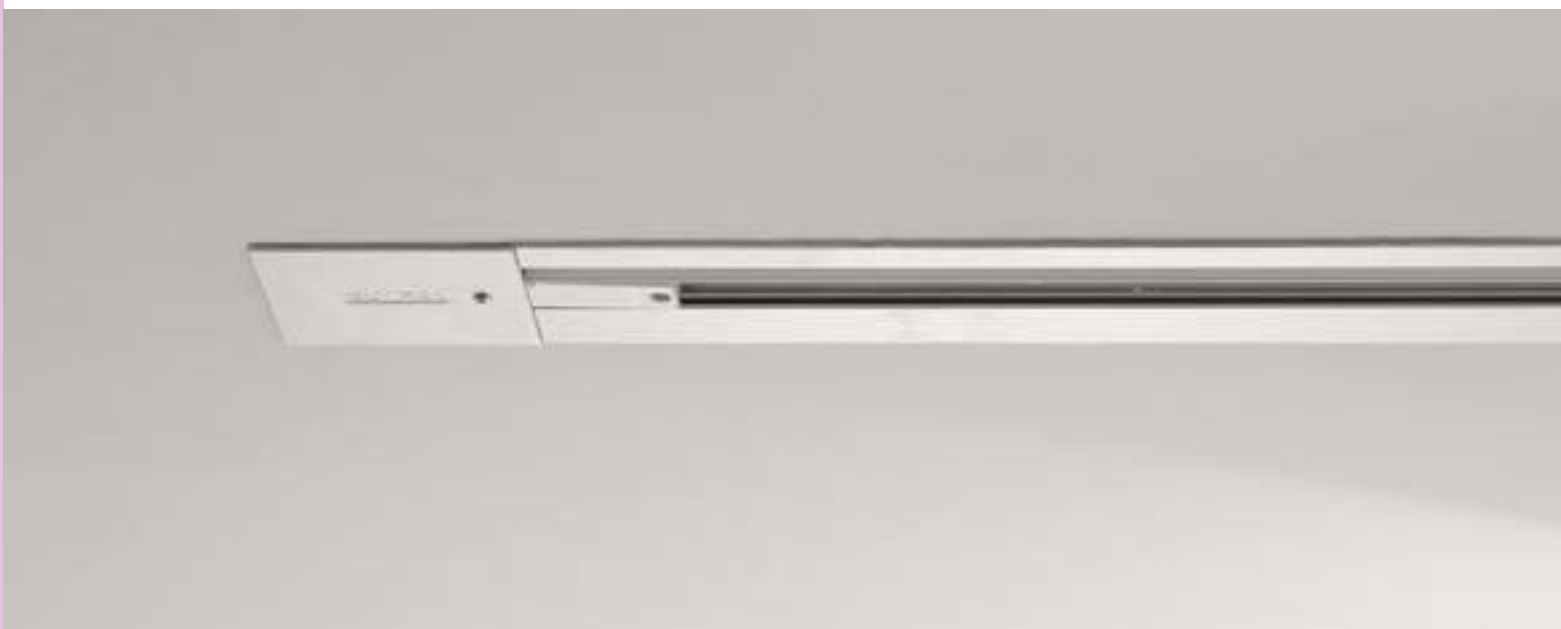

Variant	Item No.
■ black	145990
□ white	1001542
■ grey	145994





## 3-CIRCUIT RECESSED TRACK

## Recessed track

	EUTRAC® 3-circuit recessed track, 2m	EUTRAC® 3-circuit recessed track, 3m
		
Rated voltage	230V -50Hz	230V -50Hz
Max. perm. current	16A	16A
Material	Aluminium/plastic	Aluminium/plastic
Colour	white RAL 9016	white RAL 9016
Length	200cm	300cm
Width	5.9cm	5.9cm
Height	4.1cm	4.1cm
Inst. Width	4cm	4cm
Weight	2.6kg	3.9kg
<b>Item No.</b>	<b>1001531</b>	<b>1001532</b>

Manufacturer: Eutrac Stromschienen GmbH



## ACCESSORIES FOR EUTRAC® 3-CIRCUIT RECESSED TRACK

Manufacturer: Eutrac Stromschienen GmbH

<p><b>Feed-in, protective conductor, left</b></p> <p>16A max. Plastic/steel L: 12.2cm W: 6cm H: 3.4cm Weight: 0.1kg 1 piece</p> <p><b>Variant</b>                      <b>Item No.</b></p> <p><input type="checkbox"/> white                              <b>1001533</b></p>	<p><b>End cap</b></p> <p>Plastic L: 2.7cm W: 6cm H: 3.2cm Weight: 0.02kg 1 piece</p> <p><b>Variant</b>                      <b>Item No.</b></p> <p><input type="checkbox"/> white                              <b>1001538</b></p>	<p><b>Longitudinal connector</b></p> <p>16A max. Plastic/steel L: 6.2cm W: 2.5cm H: 2.7cm Weight: 0.09kg 1 piece</p> <p><b>Variant</b>                      <b>Item No.</b></p> <p><input type="checkbox"/> white                              <b>1001539</b></p>
<p><b>Feed-in, protective conductor, right</b></p> <p>16A max. Plastic/steel L: 12.2cm W: 6cm H: 3.4cm Weight: 0.1kg 1 piece</p> <p><b>Variant</b>                      <b>Item No.</b></p> <p><input type="checkbox"/> white                              <b>1001534</b></p>	<p><b>L-connector</b></p> <p>16A max. Plastic/steel L: 16cm W: 16cm H: 3.2cm Weight: 0.24kg Earth inside, with feed capability 1 piece</p> <p><b>Variant</b>                      <b>Item No.</b></p> <p><input type="checkbox"/> white                              <b>1001537</b></p>	<p><b>Mounting spring clip</b></p> <p>Steel L: 2cm W: 1cm H: 2,5cm Weight: 0.03kg 6 pieces</p> <p><b>Variant</b>                      <b>Item No.</b></p> <p><input checked="" type="checkbox"/> grey                              <b>145551</b></p>
<p><b>L-connector</b></p> <p>16A max. Plastic/steel L: 16cm W: 16cm H: 3.2cm Weight: 0.24kg Earth outside, with feed-in capability 1 piece</p> <p><b>Variant</b>                      <b>Item No.</b></p> <p><input type="checkbox"/> white                              <b>1001536</b></p>		

# STAYING ON TRACK.

SIMPLY WELL ILLUMINATED WITH  
1-CIRCUIT 240V TRACKS.

---

Thanks to the holes in the profile, the flat aluminium track can be attached to the wall or ceiling in a quick and easy way. When doing this you have the choice between a recessed version and a surface-mounted version, available in several colours.



1002873 513



1001862 520





## HIGH VOLTAGE 1-CIRCUIT TRACK

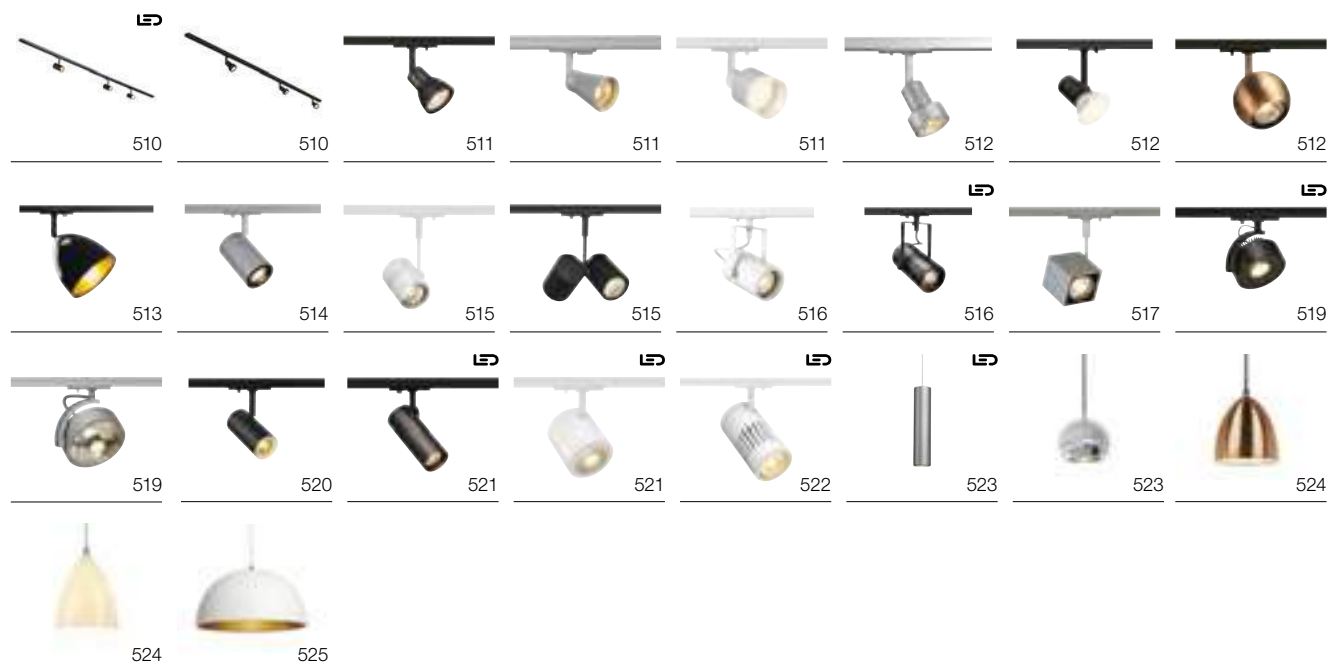

Suitable recessed and surface mounted track systems as well as accessories can be found on pages 526-529



Other luminaires and variants can be found online at [www.slv.com](http://www.slv.com)  
 You can find manufacturer's details for our recommended lamps in the chapter 'Lightbulbs', from page 844

**NOBLO SPOT**  
1-circuit, Triple Track Set

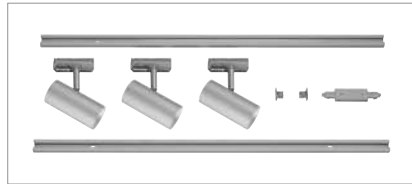

**PURI TRACK**  
1-circuit, Triple Track Set

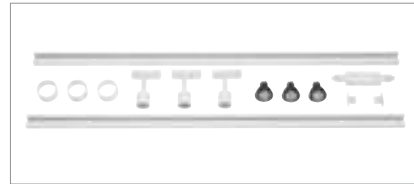

**Product details**

220-240V ~50/60Hz | 350mA  
Total wattage: 22.5W  
Material: aluminium

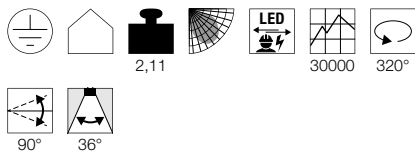

**Note**

**The set consists of:**  
2 x 1m high-voltage track  
1 x long connectro with feed-in capability  
1 x 2 end caps  
3 x NOBLO spots

**Product details**

230V -50Hz  
Total wattage: 12.9W  
Material: aluminium



**Note**

**The set consists of:**  
2 x 1m high-voltage track  
1 x longitudinal connector  
1 x 2 end caps  
3 x PURI spots  
3 x GU10 lamps  
3 x deco rings for GU10

**Lamp details**

3x 4.3W LED GU10 51mm

Variant	Item No.
1860lm   2700K   CRI>80	
■ black	<b>1002610</b>
1860lm   2700K   CRI>80	
□ white	<b>1002611</b>
1860lm   2700K   CRI>80	
■ grey	<b>1002612</b>

Variant	Item No.
GU10   LED GU10 51mm	
■ black	<b>143190</b>
GU10   LED GU10 51mm	
□ white	<b>143191</b>
GU10   LED GU10 51mm	
■ grey	<b>143194</b>

1002611 510



144201 511

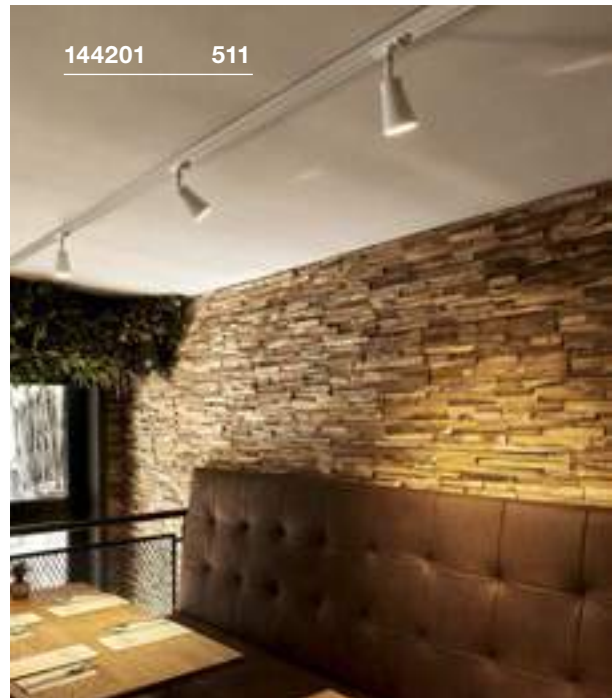

1001868 511



**PURIA TRACK**  
1-circuit, QPAR51

SOCKET  
INSIDE



**Product details**

230V -50Hz  
Material: aluminium/glass



**Dimensional drawing**

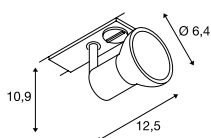

**Recommended lamp**

GU10 5.1W 48°  
2700-6500K 350lm  
6kWh/1000h  
Item No. 1001918



LED GU10 5.6W 60°  
2200-6700K 350lm  
6kWh/1000h  
Item No. 1001919



**Lamp details**

max. 10W QPAR51

Variant	Item No.
GU10   QPAR51	
■ black	143450
GU10   QPAR51	
□ white	143451
GU10   QPAR51	
■ grey	143454

**AVO TRACK**  
1-circuit, QPAR51

SOCKET  
INSIDE



**Product details**

230V ~50/60Hz  
Material: steel

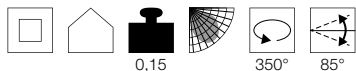

**Dimensional drawing**

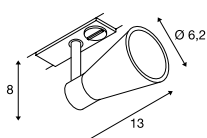

**Recommended lamp**

LED GU10 6W 36°  
2700K 460lm  
6kWh/1000h  
Item No. 1005076



LED GU10 6W 36°  
3000K 460lm  
6kWh/1000h  
Item No. 1005079



**Lamp details**

max. 50W QPAR51  
Diameter: 5cm max.

Variant	Item No.
GU10   QPAR51	
■ black	144200
GU10   QPAR51	
□ white	144201
GU10   QPAR51	
■ grey	144204

**PURI TRACK**  
1-circuit, QPAR51

SOCKET  
INSIDE



**Product details**

230V -50Hz  
Material: aluminium/plastic



**Dimensional drawing**

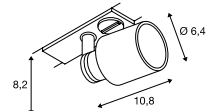

**Recommended lamp**

LED GU10 5.5W 38°  
2700K 400lm  
6kWh/1000h  
Item No. 1001030



LED GU10 6W 36°  
3000K 460lm  
6kWh/1000h  
Item No. 1005079



**Lamp details**

max. 10W QPAR51

Variant	Item No.
GU10   QPAR51	
■ black	1001868
GU10   QPAR51	
□ white	1001869
GU10   QPAR51	
■ grey	1001870

**PURI TRACK**  
1-circuit, QPAR51



SOCKET  
INSIDE



**SPOT TRACK**  
1-circuit, E27



SOCKET  
INSIDE



**LIGHT EYE® 90**  
1-circuit, QPAR51



SOCKET  
INSIDE

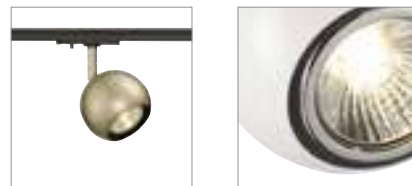

- The optional deco ring for the lamp in the appropriate colour reduces the distance between the housing and the lamp

**Product details**

230V -50Hz  
Material: aluminium/polycarbonate (PC)



**Product details**

230V -50Hz  
Material: aluminium



**Product details**

230V ~50/60Hz  
Material: steel



**Dimensional drawing**

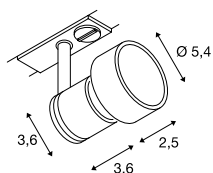

**Dimensional drawing**

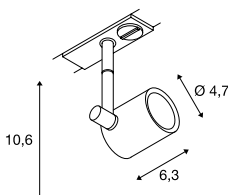

**Dimensional drawing**

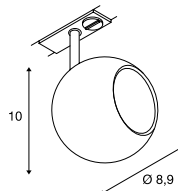

**Recommended lamp**

LED GU10 6W 36°  
4000K 460lm  
6kWh/1000h  
Item No. 1005082



LED GU10 6W 36°  
2700K 460lm  
6kWh/1000h  
Item No. 1005077



**Lamp details**

max. 50W QPAR51

Variant	Item No.
GU10   QPAR51	
■ black	143390
□ white	143391
■ grey	143392

**Recommended lamp**

LED E27 17W 45°  
3000K 1430lm  
17kWh/1000h  
Item No. 560473



LED E27 8W  
2000-2900K 300lm  
8kWh/1000h  
Item No. 1003096



**Lamp details**

max. 75W QPAR20  
optional: QPAR30

Variant	Item No.
E27   QPAR20	
■ black	1001874
□ white	1001875
■ grey	1001876

**Recommended accessories**

- Lamp deco ring diameter 5.7cm  
Item No. 151040
- Lamp deco ring diameter 5.7cm  
Item No. 151041
- Lamp deco ring diameter 5.7cm  
Item No. 151049



**Recommended lamp**

LED GU10 5.5W 38°  
2700K 400lm  
6kWh/1000h  
Item No. 1001030



LED GU10 6W 36°  
2700K 460lm  
6kWh/1000h  
Item No. 1005077



**Lamp details**

max. 50W QPAR51

Variant	Item No.
GU10   QPAR51	
■ black/chrome	144010
□ white/chrome	144011
■ gold	144013
■ copper	144019





143390 512

## PARA CONE 14

1-circuit, QPAR51



SOCKET  
INSIDE



### Product details

220-240V ~50/60Hz  
Material: steel



0,4 300° 80°

### Dimensional drawing

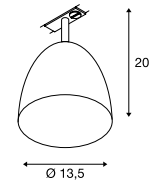

### Recommended lamp

GU10 5.1W 48°  
2700-6500K 350lm  
6kWh/1000h  
Item No. 1001918



LED GU10 4W  
2600K 260lm  
4kWh/1000h  
Item No. 1003101



### Lamp details

max. 25W QPAR51

Variant	Item No.
GU10	
■ glossy black	1002873
□ glossy white	1002874
■ copper	1002875

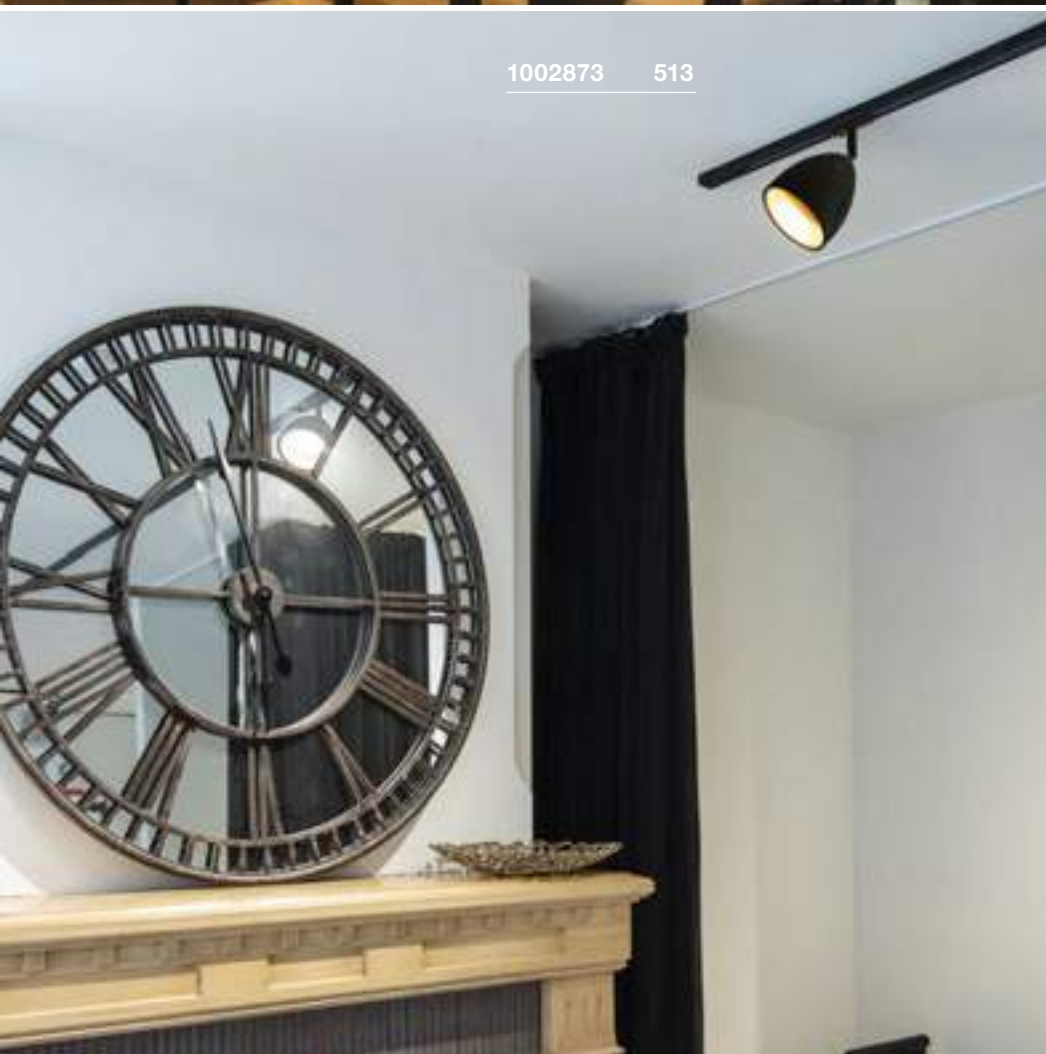

1002873 513

**ENOLA B TRACK**  
1-circuit, QPAR51



**SOCKET INSIDE**



**Product details**

230V ~50/60Hz  
Material: aluminium/steel



**Dimensional drawing**

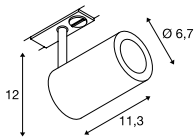

**Recommended lamp**

LED GU10 5.5W 38°  
2700K 400lm  
6kWh/1000h  
Item No. 1001030



LED GU10 6W 36°  
3000K 460lm  
6kWh/1000h  
Item No. 1005079



**Lamp details**

max. 50W QPAR51  
Diameter: 5cm max. L. 6.7cm max.

Variant	Item No.
GU10   QPAR51	
■ black	1002110
GU10   QPAR51	
□ white	1002111
GU10   QPAR51	
■ grey	1002113



1002111 514



143440 515



143430 515

**BIMA**  
1-circuit, single, QPAR51



SOCKET  
INSIDE



**Product details**

220-240V ~50/60Hz  
Material: aluminium



**Dimensional drawing**

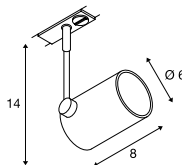

**Recommended lamp**

LED GU10 6W 36°  
3000K 460lm  
6kWh/1000h  
Item No. 1005080



LED GU10 5.5W 38°  
2700K 400lm  
6kWh/1000h  
Item No. 1001030



**Lamp details**

max. 50W QPAR51  
Diameter: 5 cm max. L: 5.7 cm max.

Variant	Item No.
GU10   QPAR51	
■ black	143440
□ white	143441
■ grey	143442

**BIMA**  
1-circuit, double, QPAR51



SOCKET  
INSIDE

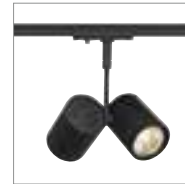

**Product details**

220-240V ~50/60Hz  
Material: aluminium

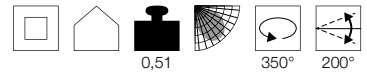

**Dimensional drawing**

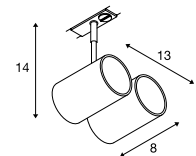

**Recommended lamp**

LED GU10 6W 36°  
3000K 460lm  
6kWh/1000h  
Item No. 1005080



LED GU10 6W 36°  
4000K 460lm  
6kWh/1000h  
Item No. 1005083



**Lamp details**

2x max. 50W QPAR51  
Diameter: 5 cm max. L: 5.7 cm max.

Variant	Item No.
GU10   QPAR51	
■ black	143430
□ white	143431
■ grey	143432

**EURO SPOT TRACK**  
1-circuit. QPAR51



SOCKET  
INSIDE



**EURO SPOT TRACK**  
1-circuit.



LED  
INSIDE



**Product details**

230V -50Hz  
Material: aluminium/glass



0,47

350°

90°

**Dimensional drawing**

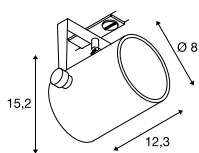

**Product details**

230V -50Hz  
Total wattage: 11W  
Material: aluminium



0,65

LED

30000

350°

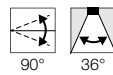

90°

36°

**Dimensional drawing**

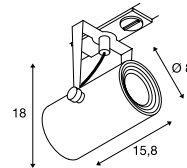

**Recommended lamp**

LED GU10 5.5W 38°  
2700K 400lm  
6kWh/1000h  
Item No. 1001030



LED GU10 5,1W 48°  
2700-6500K 350lm  
6kWh/1000h  
Item No. 1001918



**Lamp details**

max. 25W QPAR51

Variant	Item No.
GU10   QPAR51	
■ black	1001861
GU10   QPAR51	
□ white	143811

Variant	Item No.
650lm   3000K   CRI>80	
■ black	1001485
650lm   3000K   CRI>80	
□ white	1001486

1001485 516



1001486 516





144013 512

143350 517

## ALTRA DICE TRACK

1-circuit, QPAR51

**SOCKET**  
**INSIDE**

### Product details

230V ~50/60Hz  
 Material: aluminium



0,37

350°

180°

### Dimensional drawing

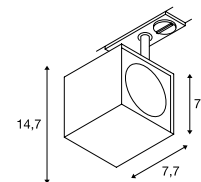

### Recommended lamp

LED GU10 6W 36°  
 3000K 460lm  
 6kWh/1000h  
**Item No. 1005080**



LED GU10 5.5W 38°  
 2700K 400lm  
 6kWh/1000h  
**Item No. 1001030**



### Lamp details

max. 50W QPAR51

Variant	Item No.
GU10   QPAR51	
■ black	143350
GU10   QPAR51	
□ white	143351
GU10   QPAR51	
■ grey	143354

1002854 519

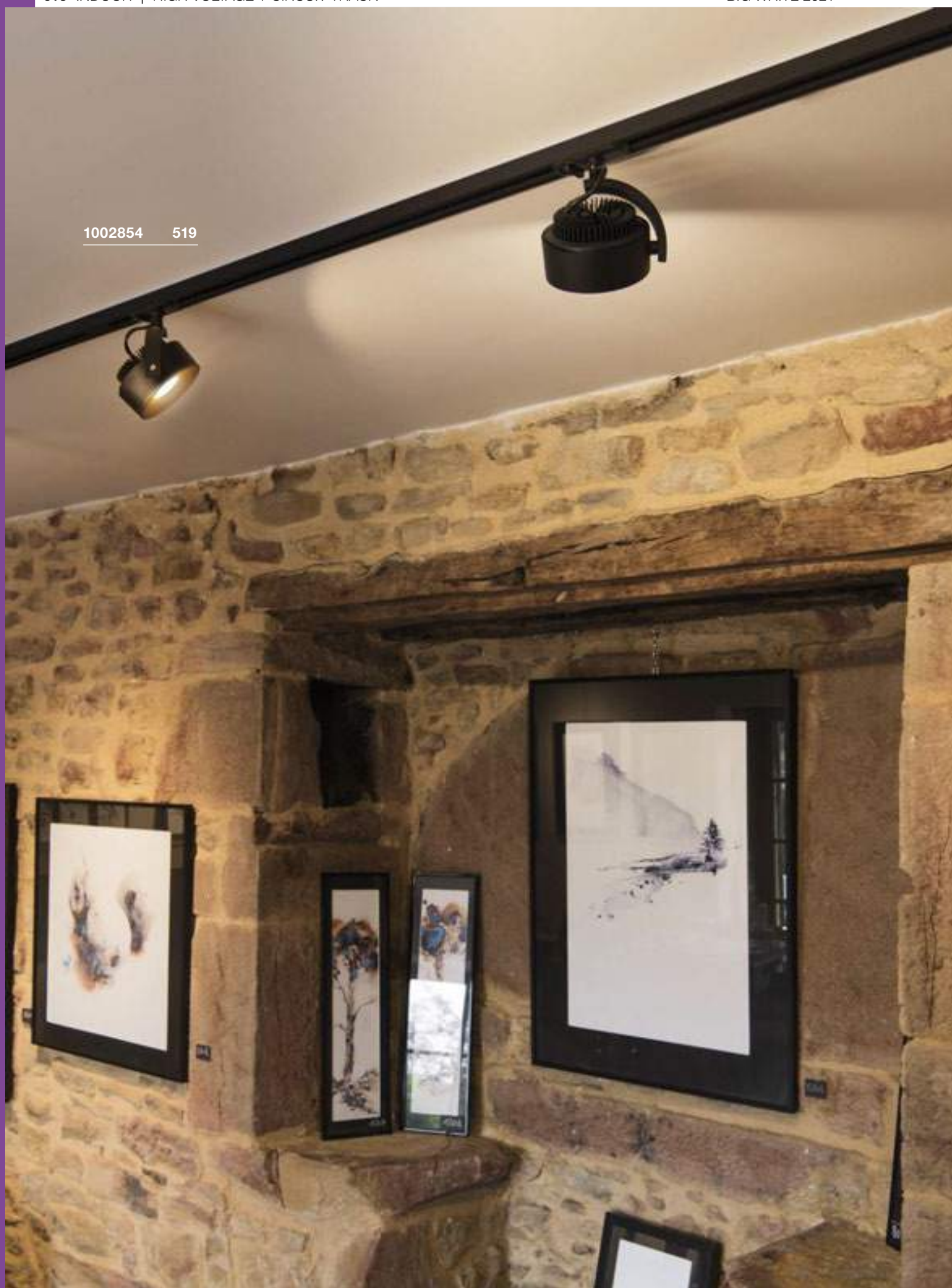



143731 519

**KALU TRACK**  
1-circuit, PHASE

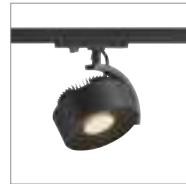

**Product details**

220-240V ~50/60Hz  
Total wattage: 13W  
Material: aluminium  
Dimmable: C

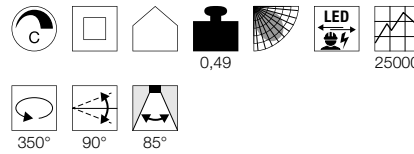

**Dimensional drawing**

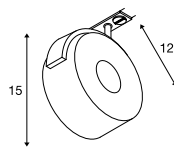

**KALU TRACK**  
1-circuit, QPAR111



SOCKET  
INSIDE

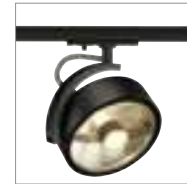

**Product details**

230V -50Hz  
Material: aluminium/plastic



**Dimensional drawing**

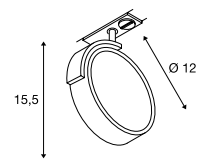

**Recommended lamp**

LED GU10 13W 55°  
2700K 840lm  
13kWh/1000h  
Item No. 1003094



LED GU10 13W 30°  
2700K 1100lm  
13kWh/1000h  
Item No. 1001242



**Lamp details**

max. 75W QPAR111

Variant	Item No.
860lm   3000K   CRI>80	
■ black	1002854
860lm   3000K   CRI>80	
□ white	143731

Variant	Item No.
GU10   QPAR111	
■ black	143540
GU10   QPAR111	
□ white	143541
GU10   QPAR111	
■ grey	143544

## NOBLO SPOT

1-circuit.



LED  
INSIDE



### Product details

220-240V ~50/60Hz | 350mA  
Total wattage: 7.5W  
Material: aluminium

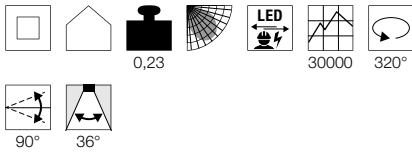

### Dimensional drawing

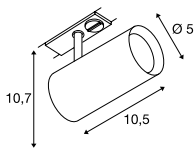

1001863 520



Variant	Item No.
620lm   2700K   CRI>80 ■ black	1001862
620lm   2700K   CRI>80 □ white	1001863
620lm   2700K   CRI>80 ■ grey	1001864





143580 521



1000712 521

**HELIA 50 TRACK**  
1-circuit



- Premium LED with CRI>90

**Product details**

220-240V ~50/60Hz | 500mA  
Total wattage: 11W  
Material: aluminium

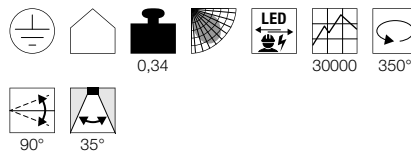

**Dimensional drawing**

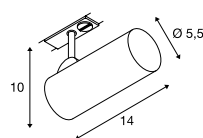

Variant	Item No.
750lm   3000K   CRI>90	
■ black	<b>143580</b>
750lm   3000K   CRI>90	
□ white	<b>143581</b>

**ENOLA C TRACK**  
1-circuit

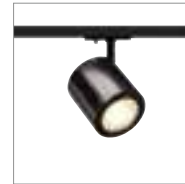

**Product details**

220-240V ~50/60Hz | 500mA  
Total wattage: 11W  
Material: aluminium/glass

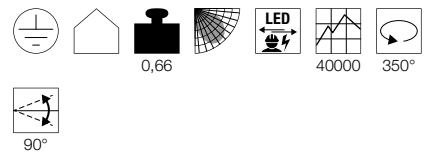

**Dimensional drawing**

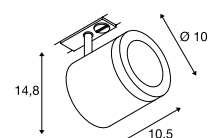

Variant	Item No.
900lm   3000K   CRI>80   35°	
■ black	<b>1000711</b>
900lm   3000K   CRI>80   35°	
□ white	<b>143941</b>
900lm   3000K   CRI>80   55°	
■ black	<b>1000712</b>
900lm   3000K   CRI>80   55°	
□ white	<b>143951</b>

**STRUCTEC**  
1-circuit



**LED**  
INSIDE



1000978 522



- Premium LED with CRI>90

**Product details**

230V ~50/60Hz  
Total wattage: 28W  
Material: aluminium

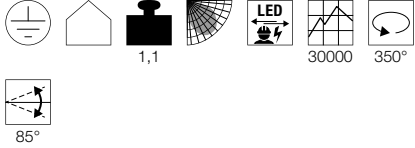

**Dimensional drawing**

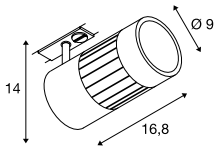

Variant	Item No.
2700lm   3000K   CRI>90   36°	
■ matt black	<b>1000974</b>
2700lm   3000K   CRI>90   36°	
□ matt white	<b>1000975</b>
2650lm   3000K   CRI>90   60°	
■ matt black	<b>1000977</b>
2650lm   3000K   CRI>90   60°	
□ matt white	<b>1000978</b>



143960 523



1000713 523

ENOLA B  
PD, QPAR51



SOCKET  
INSIDE



Product details

230V -50Hz  
Material: aluminium/steel



Dimensional drawing

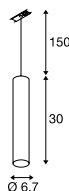

Recommended lamp

LED GU10 6W 36°  
3000K 460lm  
6kWh/1000h  
Item No. 1005080



LED GU10 6W 36°  
3000K 460lm  
6kWh/1000h  
Item No. 1005079



Lamp details

max. 50W QPAR51

Variant	Item No.
GU10   QPAR51	
■ black	143960
□ white	143961
■ grey	143964

LIGHT EYE® 150  
PD, QPAR111



SOCKET  
INSIDE

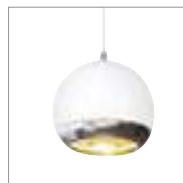
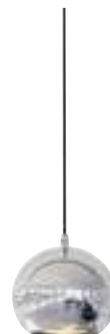

Product details

230V -50Hz  
Material: steel



Dimensional drawing

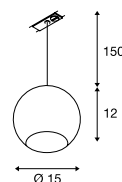

Recommended lamp

LED GU10 13W 30°  
2700K 1100lm  
13kWh/1000h  
Item No. 1001242



LED GU10 13W 140°  
2700K 1000lm  
13kWh/1000h  
Item No. 1001244



Lamp details

max. 75W QPAR111

Variant	Item No.
GU10   QPAR111	
■ black/chrome	1000713
□ white/chrome	143621
■ chrome	143620

**PARA CONE 14**  
1-circuit, PD, QPAR51



SOCKET  
INSIDE



- Can be combined into a 'lighting group' by means of individual configuration.

**Product details**

230V -50Hz  
Material: aluminium



**Dimensional drawing**

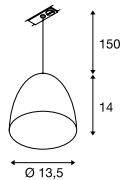

**Recommended lamp**

LED GU10 4W  
2600K 260lm  
4kWh/1000h  
Item No. 1003101



LED GU10 3,7W 36°  
2700K 260lm  
4kWh/1000h  
Item No. 560122



**Lamp details**

max. 35W QPAR51

Variant	Item No.
GU10   QPAR51 ■ glossy black	143990
GU10   QPAR51 □ glossy white	143991
GU10   QPAR51 ■ copper	1001968

**TONGA®**  
1-circuit, PD, E14



SOCKET  
INSIDE



- Ceramic shade

**Product details**

220-240V ~50/60Hz  
Material: aluminium/glass

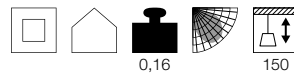

**Dimensional drawing**

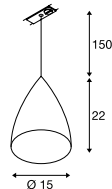

**Recommended lamp**

LED E14 4,5W 280°  
2700K 470lm  
5kWh/1000h  
Item No. 1002128



LED E14 6,5W 280°  
2700K 480lm  
7kWh/1000h  
Item No. 560372



**Lamp details**

max. 60W C35  
Diameter: 5cm max. L: 13cm max.

Variant	Item No.
E14   C35 ■ grey/glossy white	143594





143930 525

## FORCHINI M 40 TRACK

1-circuit, E27



SOCKET  
INSIDE



- Double-walled construction with internal reflector
- Textile cable in housing colour

### Product details

230V -50Hz  
Material: aluminium/steel



1,52 150

### Dimensional drawing

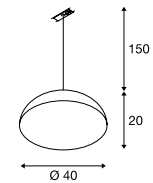

### Note

Pendant light adaptor colour  
silver-grey [143930]  
white [143931]  
black [143932]

### Recommended lamp

LED E27 7W 330°  
2700K 806lm  
8kWh/1000h  
Item No. 1001035



LED E27 7W 280°  
2200-2700K 830lm  
7kWh/1000h  
Item No. 1002126



### Lamp details

max. 40W A60  
Diameter: 6.8 cm max. L: 15.2 cm max

Variant	Item No.
E27   A60 ■ black/gold Silver-grey adaptor	143930
E27   A60 ■ white/gold White adaptor	143931
E27   A60 ■ black/gold Black adaptor	143932



143931 525

## RECESSED TRACK 2M

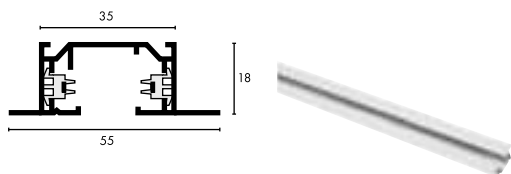

1-CIRCUIT RECESSED TRACK



Rated voltage	230V ~50Hz/60Hz
Max. perm. current	16A
Material	aluminium
Colour	white
Length	200cm
Width	5.5cm
Height	1.8cm
Installation width	4cm
Weight	1.16kg

<b>Item No.</b>	<b>143221</b>
-----------------	---------------



### Ceiling suspension

Stainless-steel/brass  
L: 500cm  
Weight: 0.2kg  
2 pieces



### Corner connector, earth on outside

16A max.  
Plastic  
L: 11.2cm W: 11.2cm H: 2cm  
Weight: 0.07kg  
earth on outside  
1 piece



### Stabiliser, long corner connector

Steel  
L: 11.5cm W: 11.5cm H: 0.5cm  
Weight: 0.06kg  
For reinforcement when mounting several rails with ceiling suspension (143140/-1/-2)  
1 piece



Variant	Item No.
<input checked="" type="checkbox"/> nickel	<b>1002845</b>

Variant	Item No.
<input type="checkbox"/> white	<b>143251</b>

Variant	Item No.
<input checked="" type="checkbox"/> matt nickel	<b>143152</b>

### Retainer bracket

Steel  
L: 7.5cm W: 1.5cm H: 4cm  
Weight: 0.03kg  
Mounting bracket for the installation of the 1-circuit mounting rail on false ceilings.  
1 piece



### Corner connector, earth on inside

16A max.  
Plastic  
L: 11.2cm W: 11.2cm H: 2cm  
Weight: 0.07kg  
earth on inside  
1 piece



### 1-circuit adapter with hook

6A max.  
Polycarbonate (PC)  
L: 8.2cm W: 3.5cm H: 7.4cm  
Weight: 0.05kg  
For pendants with an additional mechanical suspension.  
Max. mechanical load 20N.  
1 piece



Variant	Item No.
<input checked="" type="checkbox"/> matt nickel	<b>143230</b>

Variant	Item No.
<input type="checkbox"/> white	<b>143261</b>

Variant	Item No.
<input checked="" type="checkbox"/> black	<b>143170</b>
<input type="checkbox"/> white	<b>143171</b>
<input checked="" type="checkbox"/> grey	<b>143172</b>

### Feed-in, earth on left

16A max.  
Plastic  
L: 10.8cm W: 5.5cm H: 2cm  
Weight: 0.41kg  
earth left  
1 piece



### Long connector inc. longitudinal stiffener

Plastic/steel  
L: 6.5cm W: 1.8cm H: 1.7cm  
Weight: 0.09kg  
The connector is installed in the track, and the stabiliser on the rear side of the track.  
1 piece



### Pendant adapter

6A max.  
Polycarbonate (PC)  
L: 8.2cm W: 3.5cm H: 4.2cm  
Weight: 0.04kg, inc. strain relief  
Max. mechanical load 20N.  
1 piece



Variant	Item No.
<input type="checkbox"/> white	<b>143231</b>

Variant	Item No.
<input type="checkbox"/> white	<b>143271</b>

Variant	Item No.
<input checked="" type="checkbox"/> black	<b>143120</b>
<input type="checkbox"/> white	<b>143121</b>
<input checked="" type="checkbox"/> grey	<b>143124</b>

### Feed-in, earth on right

16A max.  
Plastic  
L: 10.8cm W: 5.5cm H: 2cm  
Weight: 0.41kg  
earth right  
1 piece



### End caps, 2 pieces

Plastic  
L: 2.7cm W: 5.5cm H: 1.8cm  
Weight: 0.01kg  
2 pieces



Variant	Item No.
<input type="checkbox"/> white	<b>143241</b>

Variant	Item No.
<input type="checkbox"/> white	<b>143281</b>

### PLANNING AID 1-CIRCUIT SURFACE MOUNTED TRACK

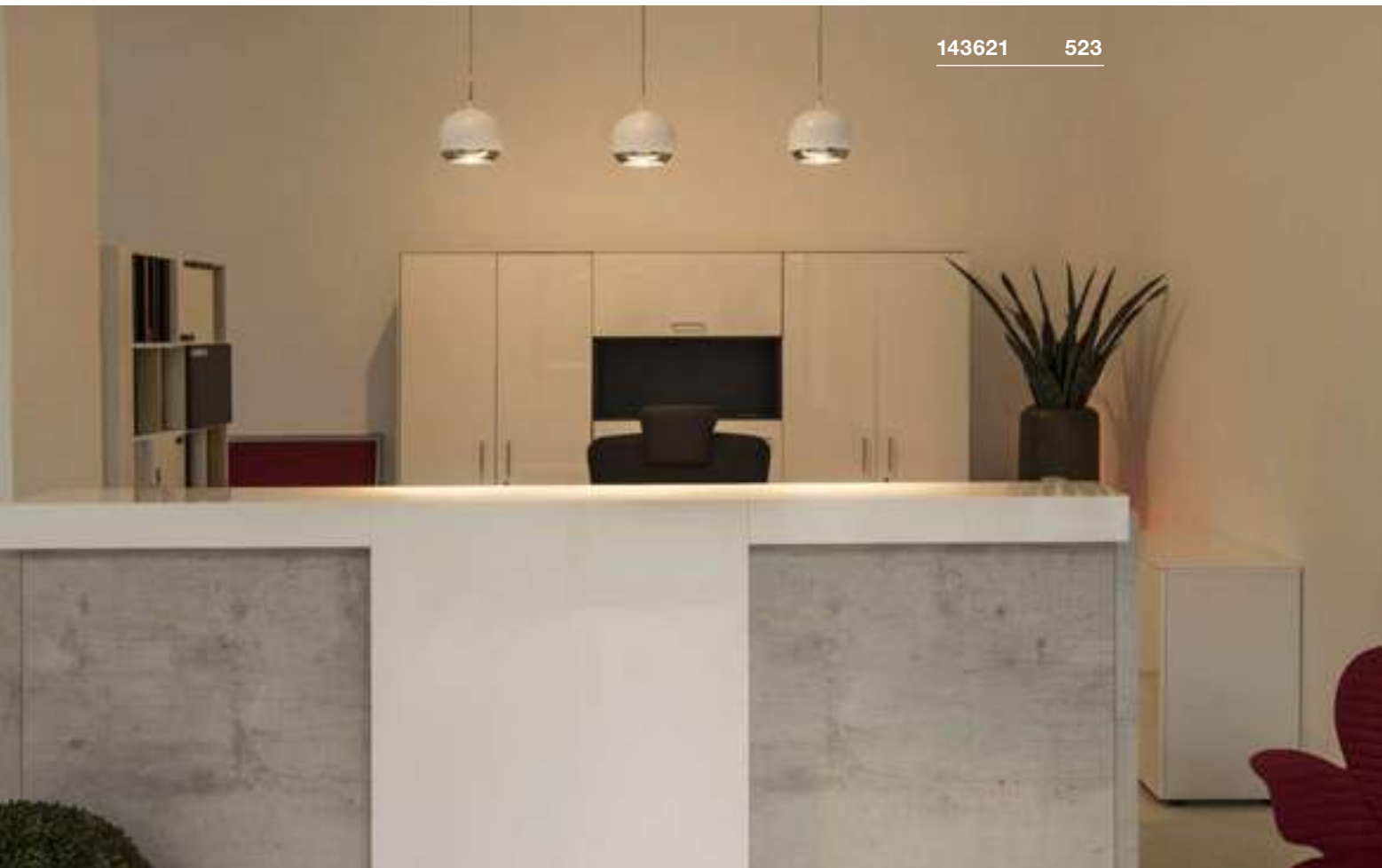
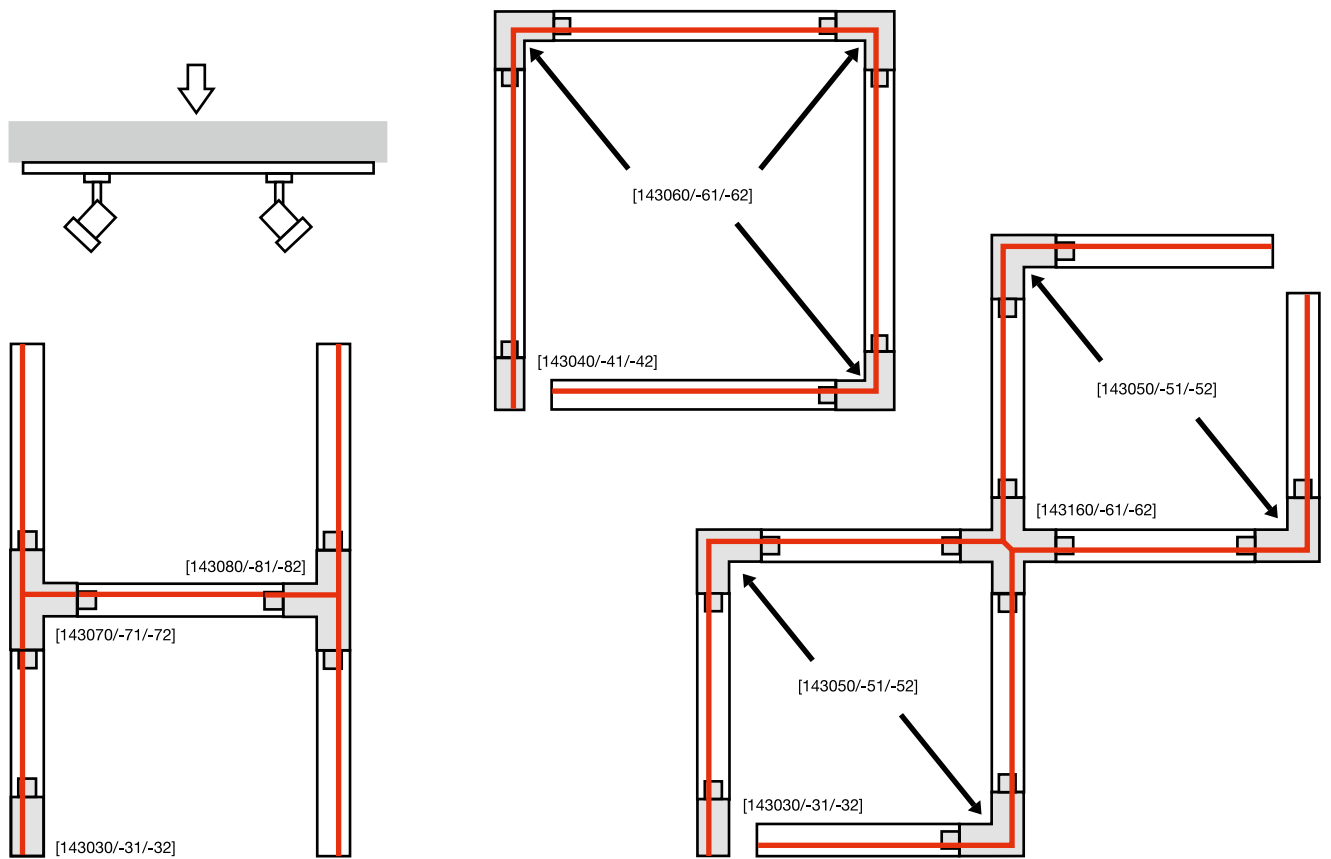

143621 523

## SURFACE MOUNTED TRACK 1M

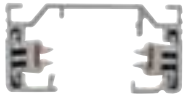

1-CIRCUIT SURFACE MOUNTED TRACK

1-CIRCUIT SURFACE MOUNTED TRACK

1-CIRCUIT SURFACE MOUNTED TRACK

Rated voltage	220-240V ~50/60Hz	220-240V ~50/60Hz	220-240V ~50Hz
Max. perm. current	16A	16A	16A
Material	aluminium	aluminium	aluminium
Colour	black	white	grey
Length	100cm	100cm	100cm
Width	3.5cm	3.5cm	3.5cm
Height	1.8cm	1.8cm	1.8cm
Weight	0.67kg	0.67kg	0.67kg
<b>Item No.</b>	<b>143010</b>	<b>143011</b>	<b>143012</b>

## SURFACE MOUNTED TRACK 2M

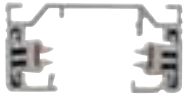

1-CIRCUIT SURFACE MOUNTED TRACK

1-CIRCUIT SURFACE MOUNTED TRACK

1-CIRCUIT SURFACE MOUNTED TRACK

Rated voltage	220-240V ~50/60Hz	220-240V ~50Hz	220-240V ~50/60Hz
Max. perm. current	16A	16A	16A
Material	aluminium	aluminium	aluminium
Colour	black	white	grey
Length	200cm	200cm	200cm
Width	3,5	3.5cm	3.5cm
Height	1.8cm	1.8cm	1.8cm
Weight	1.34kg	1.34kg	1.34kg
<b>Item No.</b>	<b>143020</b>	<b>143021</b>	<b>143022</b>

## SURFACE MOUNTED TRACK 3M

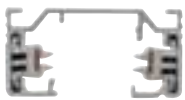

1-CIRCUIT SURFACE MOUNTED TRACK

1-CIRCUIT SURFACE MOUNTED TRACK

1-CIRCUIT SURFACE MOUNTED TRACK

Rated voltage	230V ~50Hz/60Hz	230V ~50Hz/60Hz	230V ~50Hz/60Hz
Max. perm. current	16A	16A	16A
Material	aluminium	aluminium	aluminium
Colour	black	white	grey
Length	300cm	300cm	300cm
Width	3.5cm	3.5cm	3.5cm
Height	1.8cm	1.8cm	1.8cm
Weight	1.6kg	1.6kg	1.6kg
<b>Item No.</b>	<b>1002151</b>	<b>1002152</b>	<b>1002153</b>



## ACCESSORIES FOR 1-CIRCUIT SURFACE MOUNTED TRACK

**Cover, 2m**

Polycarbonate (PC)  
L: 200cm W: 1.8cm H: 0.75cm  
Weight: 0.08kg  
2 pieces



Variant	Item No.
■ black	1004783
□ white	1004785
■ grey	1004784

**Ceiling suspension**

Stainless-steel/brass  
L: 500cm  
Weight: 0.2kg  
2 pieces



Variant	Item No.
■ Nickel	1002845

**Feed-in, earth on left**

16A max.  
Polycarbonate (PC)  
L: 10.4cm W: 3.5cm H: 1.8cm  
Weight: 0.04kg  
earth on left  
1 piece



Variant	Item No.
■ black	143030
□ white	143031
■ grey	143032

**Feed-in, earth on right**

16A max.  
Polycarbonate (PC)  
L: 10.4cm W: 3.5cm H: 1.8cm  
Weight: 0.04kg  
earth on right  
1 piece



Variant	Item No.
■ black	143040
□ white	143041
■ grey	143042

**Corner connector, earth on outside**

16A max.  
Polycarbonate (PC)  
L: 10.4cm W: 10.4cm H: 1.8cm  
Weight: 0.07kg  
earth on outside  
1 piece



Variant	Item No.
■ black	143050
□ white	143051
■ grey	143052

**Corner connector, earth on outside**

16A max.  
Polycarbonate (PC)  
L: 10.4cm W: 10.4cm H: 1.8cm  
Weight: 0.07kg  
earth on outside  
1 piece



Variant	Item No.
■ black	143060
□ white	143061
■ grey	143062

**X-connector**

16A max.  
Polycarbonate (PC)  
L: 9.5cm W: 17.2cm H: 1.8cm  
Weight: 0.13kg  
1 piece



Variant	Item No.
■ black	143160
□ white	143161
■ grey	143162

**1-circuit pendant adapter**

6A max.  
Plastic PC  
L: 8.2cm W: 3.5cm H: 4.2cm  
Max. mechanical load 20N.  
1 piece



Variant	Item No.
■ black	143120
□ white	143121
■ grey	143124

**Longitudinal connector, electrical**

16A max.  
Polycarbonate (PC)  
L: 6.4cm W: 3.5cm H: 1.8cm  
Weight: 0.02kg  
1 piece



Variant	Item No.
■ black	143090
□ white	143091
■ grey	143092

**Longitudinal connector with feed-in capability**

16A max.  
Polycarbonate (PC)  
L: 17.2cm W: 3.5cm H: 1.8cm  
Weight: 0.07kg  
1 piece



Variant	Item No.
■ black	143100
□ white	143101
■ grey	143102

**T-connector, earth on left**

16A max.  
Polycarbonate (PC)  
L: 17.2cm W: 10.4cm H: 1.8cm  
Weight: 0.1kg  
earth on left  
1 piece



Variant	Item No.
■ black	143070
□ white	143071
■ grey	143072

**T-connector, earth on right**

16A max.  
Polycarbonate (PC)  
L: 17.2cm W: 10.4cm H: 1.8cm  
Weight: 0.1kg  
earth on right  
1 piece



Variant	Item No.
■ black	143080
□ white	143081
■ grey	143082

**Flex connector**

16A max.  
Polycarbonate (PC)  
L: 16.4cm W: 3.5cm H: 1.8cm  
Weight: 0.1kg  
1 piece



Variant	Item No.
■ black	143110
□ white	143111
■ grey	143112

**End caps, 2 pieces**

Polycarbonate (PC)  
L: 0.4cm W: 3.5cm H: 1.8cm  
Weight: 0.01kg  
2 pieces



Variant	Item No.
■ black	143130
□ white	143131
■ grey	143132

**Stabiliser, X-connector**

Steel  
L: 19.7cm W: 19.7cm H: 0.5cm  
Weight: 0.11kg  
For reinforcement when mounting several tracks with ceiling suspension (143140/-1/-2).  
1 piece



Variant	Item No.
■ grey	143169

**Stabiliser, longitudinal connector**

Steel  
L: 19.7cm W: 3.2 cm H: 1.3 cm  
Weight: 0.08kg  
For reinforcement when mounting several tracks with ceiling suspension (143141/-2).  
1 piece



Variant	Item No.
■ matt nickel	143151

**Ceiling plate**

6A max.  
Polycarbonate (PC)  
Diameter: 12.1cm H: 2.5cm  
Weight: 0.1kg  
1 piece



Variant	Item No.
■ black	143380
□ white	143381
■ grey	143382



# SNAPPY AND CHIC.

THE DECORATIVE EASYTEC® II  
HIGH-VOLTAGE TRACK SYSTEM.

You can create an individual light atmosphere in just a few steps with the decorative track system. The aluminium carrier tracks are available in different colours, and can therefore be ideally attuned to your room environment.



184450 535

184440 535

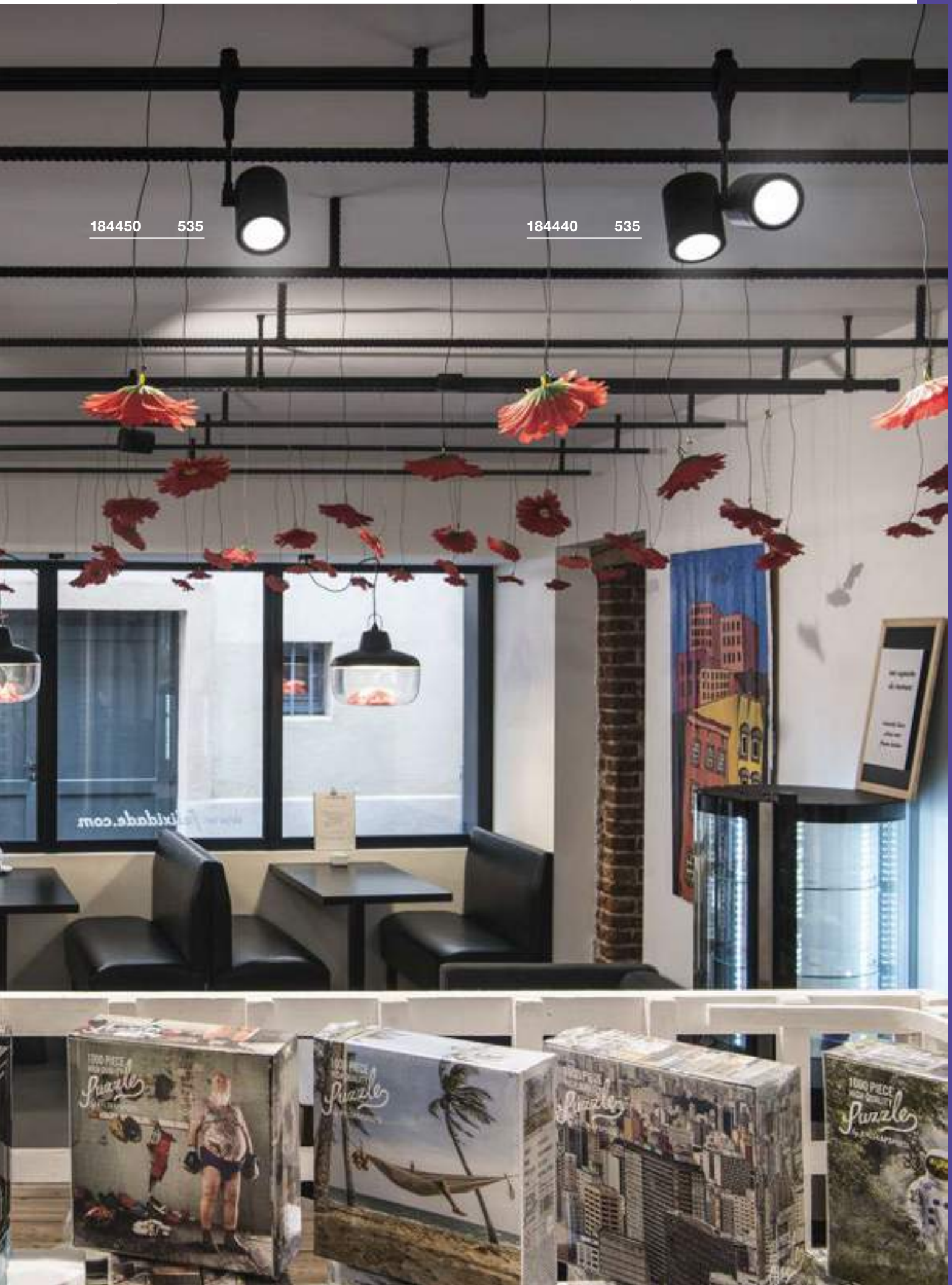

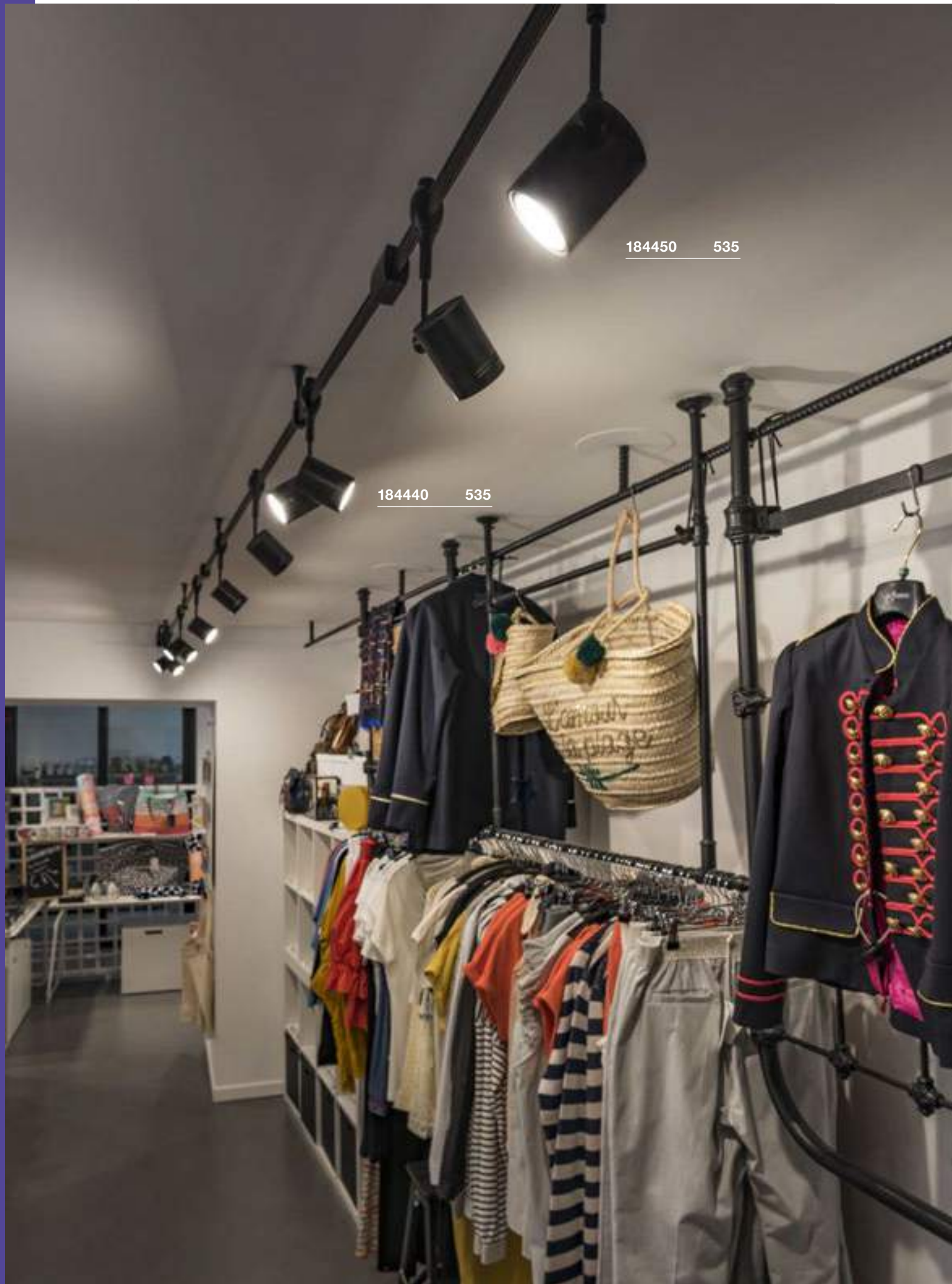

184450 535

184440 535



184440 535

184450 535

## HIGH-VOLTAGE EASYTEC® II



Suitable tracks and accessories can be found on page 539

**i** Other luminaires and variants can be found online at [www.slv.com](http://www.slv.com)  
 You can find manufacturer's details for our recommended lamps in the chapter 'Lightbulbs', from page 844

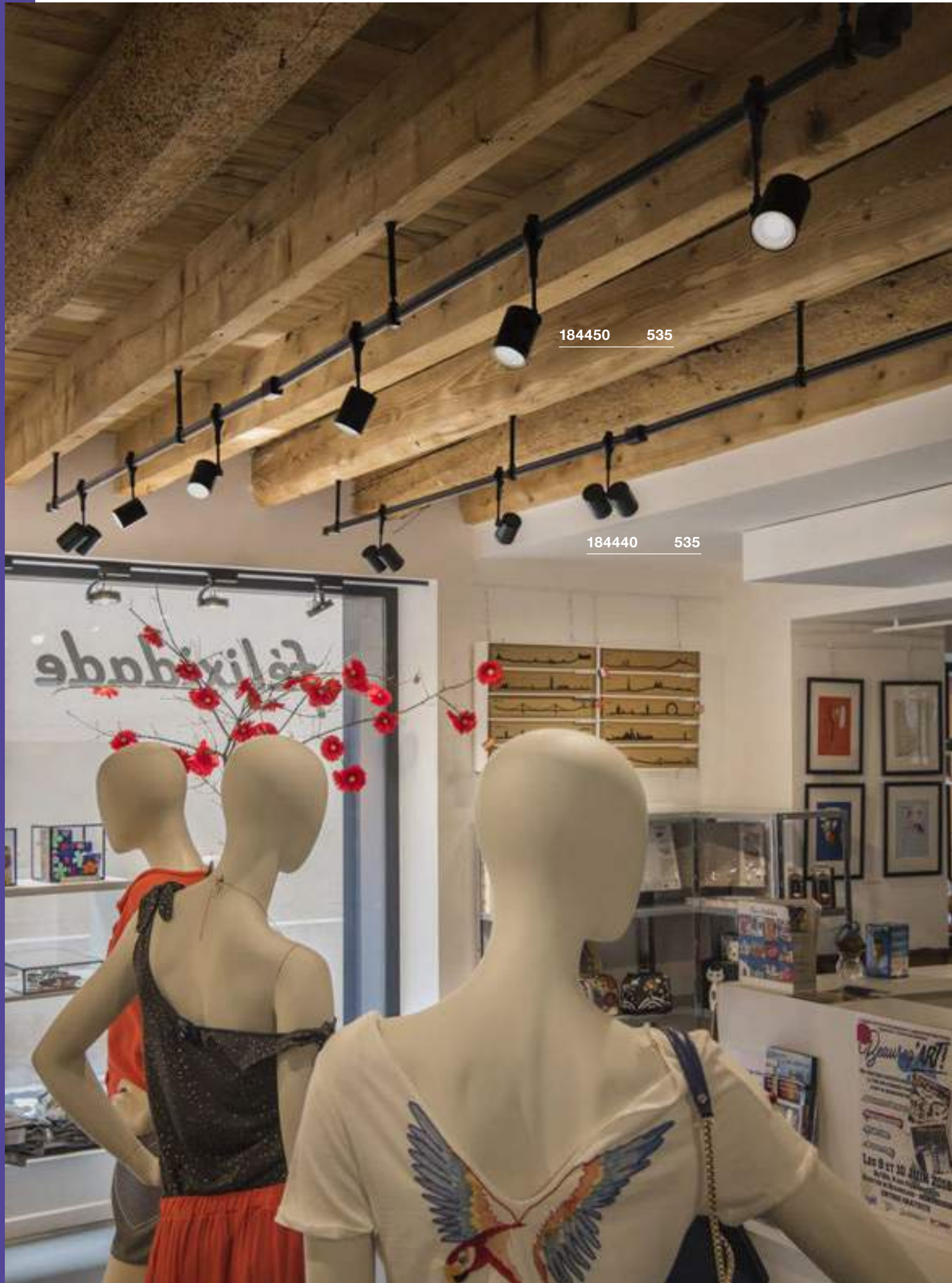

184450 535

184440 535



184450 535



184440 535

**BIMA**  
EASYTEC® II, single, QPAR51



SOCKET  
INSIDE



**Product details**

220-240V ~50/60Hz  
Material: aluminium



**Dimensional drawing**

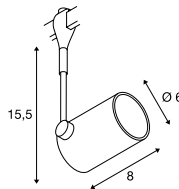

**Recommended lamp**

LED GU10 6W 36°  
3000K 460lm  
6kWh/1000h  
Item No. 1005080



LED GU10 5.5W 38°  
2700K 400lm  
6kWh/1000h  
Item No. 1001030



**Lamp details**

max. 50W QPAR51  
Diameter: 5.1cm max. L: 5.7cm max.

Variant	Item No.
GU10   QPAR51	
■ black	184450
GU10   QPAR51	
■ grey	184452

**BIMA 2**  
EASYTEC® II, double, QPAR51



SOCKET  
INSIDE



**Product details**

220-240V ~50/60Hz  
Material: aluminium



**Dimensional drawing**

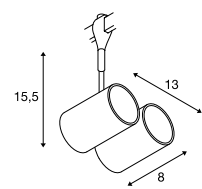

**Recommended lamp**

LED GU10 6W 36°  
3000K 460lm  
6kWh/1000h  
Item No. 1005078



LED GU10 6W 36°  
4000K 460lm  
6kWh/1000h  
Item No. 1005081



**Lamp details**

2x max. 50W QPAR51  
Diameter: 5.1cm max. L: 5.7cm max.

Variant	Item No.
GU10   QPAR51	
■ black	184440

**KANO**  
 EASYTEC® II, QPAR51

**SOCKET**  
**INSIDE**

**ANILA**  
 EASYTEC® II, QPAR51

**SOCKET**  
**INSIDE**

**Product details**

 220-240V ~50/60Hz  
 Material: aluminium/glass

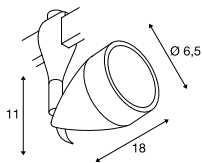
**Dimensional drawing**

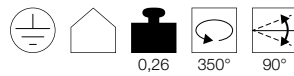
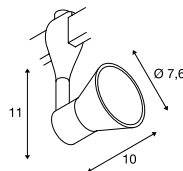
**Product details**

 230V -50Hz  
 Material: aluminium/glass

**Dimensional drawing**

**Recommended lamp**

 LED GU10 5.5W 38°  
 2700K 400lm  
 6kWh/1000h  
**Item No. 1001030**

 LED GU10 6W 36°  
 3000K 460lm  
 6kWh/1000h  
**Item No. 1005079**

**Recommended lamp**

 LED GU10 6W 36°  
 4000K 460lm  
 6kWh/1000h  
**Item No. 1005081**

 LED GU10 6W 36°  
 2700K 460lm  
 6kWh/1000h  
**Item No. 1005077**

**Lamp details**

 max. 50W QPAR51  
 Diameter: 5.1cm max. L: 5.7cm max.

Variant	Item No.
GU10   QPAR51	
frosted glass	184071

**Lamp details**

 max. 50W QPAR51  
 Diameter: 5.1cm max. L: 5.7cm max.

Variant	Item No.
GU10   QPAR51	
black/clear	184630
transparent	184634







185590 537



185590 537

**LIGHT EYE® 150 TRACK**  
EASYTEC® II, QPAR111



SOCKET  
INSIDE



**LIGHT EYE® 150 TRACK**  
EASYTEC® II, PD, QPAR111



SOCKET  
INSIDE



**Product details**

230V -50Hz  
Material: steel



0,55 350° 90°

**Dimensional drawing**

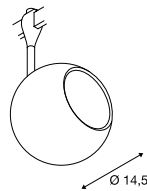

**Product details**

230V -50Hz  
Material: steel



0,7 150

**Dimensional drawing**

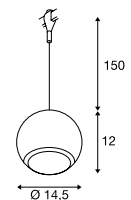

**Recommended lamp**

LED GU10 13W 30°  
2700K 1100lm  
13kWh/1000h  
Item No. 1001242



LED GU10 13W 30°  
4000K 1100lm  
13kWh/1000h  
Item No. 1003087



**Lamp details**

max. 75W QPAR111

Variant	Item No.
GU10   QPAR111	
■ black/chrome	185580

**Recommended lamp**

LED GU10 13W 30°  
2700K 1100lm  
13kWh/1000h  
Item No. 1001242



LED GU10 13W 30°  
4000K 1100lm  
13kWh/1000h  
Item No. 1003087



**Lamp details**

max. 75W QPAR111

Variant	Item No.
GU10   QPAR111	
■ black	184590
GU10   QPAR111	
■ black/chrome	185590

**TONGA®**  
EASYTEC® II, PD, E14



SOCKET  
INSIDE

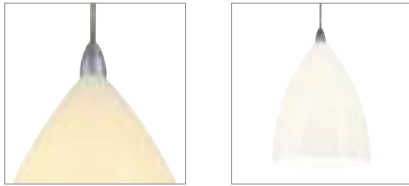

- Ceramic shade

**Product details**

230V -50Hz  
Material: aluminium/glass



1,07

150

**Dimensional drawing**

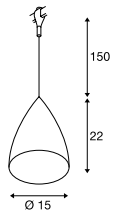

**Recommended lamp**

LED E14 4,5W 280°  
2700K 470lm  
5kWh/1000h  
Item No. 1002128



LED E14 6,5W 280°  
2700K 480lm  
7kWh/1000h  
Item No. 560372



**Lamp details**

max. 60W C35  
Diameter: 5cm max. L: 13cm max.

Variant	Item No.
E14   C35	
glossy white/black	184530
E14   C35	
glossy white/grey	184534

184534 538





EASYTEC® II  
Tracks 2m, inc. end caps

EASYTEC® II  
Tracks 2m, inc. end caps

Rated voltage	230V -50Hz	230V -50Hz
Max. current load	16A	16A
Material	aluminium	aluminium
Colour	black	grey
Length	200cm	200cm
Width	1cm	1cm
Height	3cm	3cm
Weight	1kg	1kg
<b>Item No.</b>	<b>184020</b>	<b>184022</b>

**Feed-in**

16A max.  
aluminium  
L: 7.5cm W: 7.5cm H: 6cm  
Weight: 0.23kg  
Cable length 40cm  
1 piece



Variant	Item No.
■ black	184004
■ grey	184002

**End caps**

Plastic  
Weight: 0.03kg  
2 pieces



Variant	Item No.
■ black	184140
■ grey	184142

**Flex connector**

16A max.  
Plastic  
L: 21.5cm W: 3cm H: 4cm  
Weight: 0.3kg  
1 piece



Variant	Item No.
■ black	184300
■ grey	184302

**Shortbox**

16A max.  
Aluminium/steel  
W: 22cm H: 10.5cm T: 6cm  
Weight: 0.57kg  
Simple installation of the tracks  
is possible with the Shortbox.  
1 piece



Variant	Item No.
■ black	184010
■ grey	184012

**Insulating connector**

aluminium  
Weight: 0.08kg  
1 piece



Variant	Item No.
■ black	184170
■ grey	184172

**Flexible ceiling bracket**

aluminium  
Weight: 0.1kg  
Adjustable from 23 to 31cm.  
1 piece



Variant	Item No.
■ black	184330
■ grey	184332

**Longitudinal connector**

16A max.  
aluminium  
Weight: 0.08kg  
1 piece



Variant	Item No.
■ black	184030
■ grey	184032

**Pendant adapter**

3A max.  
Aluminium/plastic  
L: 13cm  
Weight: 0.1kg  
1 piece



Variant	Item No.
■ black	184290
■ grey	184292

**Bending machine**

Steel/plastic  
Weight: 2.76kg  
1 piece



Variant	Item No.
■ grey	184000

**Ceiling suspension, flexible**

aluminium  
Weight: 0.11kg  
Adjustable from 18cm to 26cm.  
1 piece



Variant	Item No.
■ black	184060
■ grey	184062

# LOVE OF DETAIL.

## LOW-VOLTAGE CABLE SYSTEM AND AND CABINET TRACKS CREATE EMPHASIS.

---

Light helps to give rooms atmosphere. Anywhere where it needs to be cosy and professional at the same time, low voltage cable systems are the right solution – because they provide room for individual lighting concepts and create cosiness. Our low-voltage our low voltage cabinet tracks are the ideal solution for accentuating product display cases.





1002862 548



1002864 549





188530

556

LOW-VOLTAGE CABLE SYSTEM AND CABINET TRACK



Suitable accessories can be found on pages 554-555 and 557

**i** Other luminaires and variants can be found online at [www.slv.com](http://www.slv.com)  
 You can find manufacturer's details for our recommended lamps in the chapter 'Lightbulbs', from page 844

**ASMARA**  
LV, QR-C51

SOCKET  
INSIDE

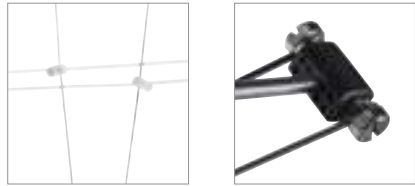

**Product details**

12V ~50Hz  
Material: stainless steel



**Dimensional drawing**

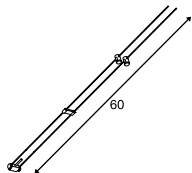

**Recommended lamp**

LED GU5.3 5,5W 36°  
2700K 450lm  
7kWh/1000h  
Item No. 1001574



LED GU5.3 5,5W 36°  
3000K 460lm  
7kWh/1000h  
Item No. 1001575



**Lamp details**

max. 35W QR-C51

Variant	Item No.
GX5.3   QR-C51	
■ glossy black	139070
GX5.3   QR-C51	
□ glossy white	139071
GX5.3   QR-C51	
■ glossy chrome	139072

**TELESKOP**  
LV, QR-C51

SOCKET  
INSIDE

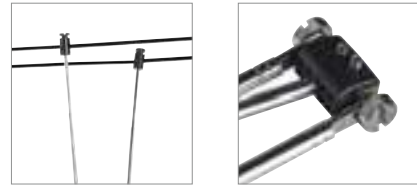

**Product details**

12V ~50Hz  
Material: brass/steel



**Dimensional drawing**

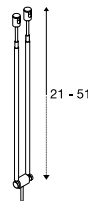

**Note**

Telescopic from 21-51cm

**Recommended lamp**

LED GU5.3 5,5W 36°  
2700K 450lm  
7kWh/1000h  
Item No. 1001574



LED GU5.3 5,5W 36°  
3000K 460lm  
7kWh/1000h  
Item No. 1001575



**Lamp details**

max. 20W QR-C51

Variant	Item No.
GX5.3   QR-C51	
■ glossy black	139080
GX5.3   QR-C51	
□ glossy white	139081
GX5.3   QR-C51	
■ glossy chrome	139082



139071 544



139081 544





139090 545



139102 545

**COSMIC**  
LV, QR-C51

SOCKET  
INSIDE



**Product details**

12V ~50Hz  
Material: steel/brass



**Dimensional drawing**

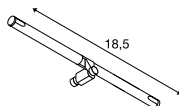

**Recommended lamp**

LED GU5.3 5,5W 36°  
2700K 450lm  
7kWh/1000h  
Item No. 1001574



LED GU5.3 5,5W 36°  
3000K 460lm  
7kWh/1000h  
Item No. 1001575



**Lamp details**

max. 35W QR-C51

Variant	Item No.
GX5.3   QR-C51	
■ glossy black	139090
GX5.3   QR-C51	
□ glossy white	139091
GX5.3   QR-C51	
■ glossy chrome	139092

**SYROS**  
LV, QR-C51

SOCKET  
INSIDE



**Product details**

12V ~50Hz  
Material: steel/brass



**Dimensional drawing**

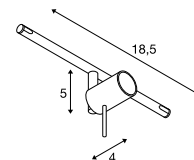

**Recommended lamp**

LED GU5.3 5,5W 36°  
2700K 450lm  
7kWh/1000h  
Item No. 1001574



LED GU5.3 5,5W 36°  
3000K 460lm  
7kWh/1000h  
Item No. 1001575



**Lamp details**

max. 50W QR-C51

Variant	Item No.
GX5.3   QR-C51	
■ glossy black	139100
GX5.3   QR-C51	
□ glossy white	139101
GX5.3   QR-C51	
■ glossy chrome	139102

SALUNA  
LV, QR-C51

SOCKET  
INSIDE



Product details

12V ~50Hz  
Material: steel/brass



0,21 350° 90°

Dimensional drawing

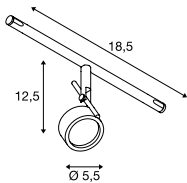

Recommended lamp

LED GU5.3 5,5W 36°  
2700K 450lm  
7kWh/1000h  
Item No. 1001574



LED GU5.3 5,5W 36°  
3000K 460lm  
7kWh/1000h  
Item No. 1001575



Lamp details

max. 35W QR-C51

Variant	Item No.
GX5.3   QR-C51	
■ glossy black	139130
GX5.3   QR-C51	
□ glossy white	139131
GX5.3   QR-C51	
■ glossy chrome	139132

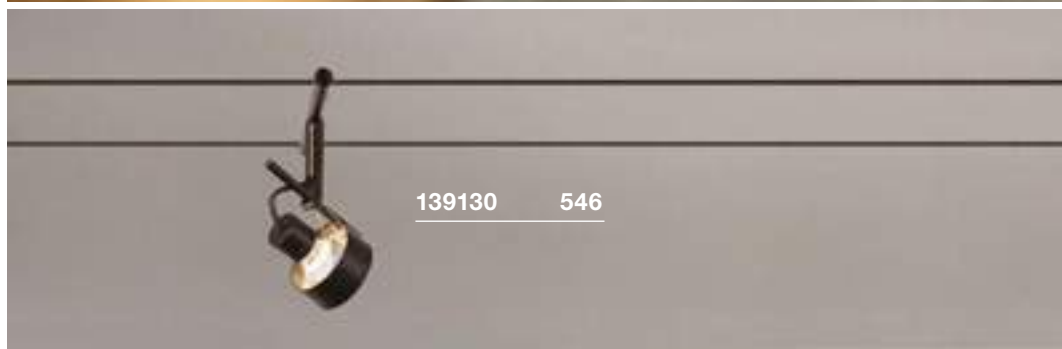

© Birgit König, Malerei, koenigb.ac@gmail.com,  
www.birgitkoenig.de



© Birgit König, Malerei, koenigb.ac@gmail.com,  
www.birgitkoenig.de



139112 547

## ORBIT LV, QR111

SOCKET  
INSIDE

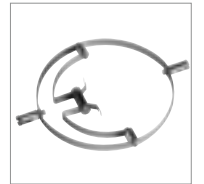
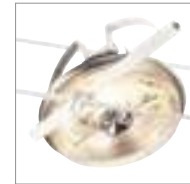

### Product details

12V ~50Hz  
Material: steel



0,11 15,5

### Dimensional drawing

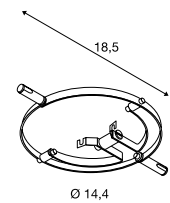

### Recommended lamp

LED G53 15W 40°  
2700K 750lm  
17kWh/1000h  
Item No. 560232



LED G53 15W 40°  
3000K 760lm  
17kWh/1000h  
Item No. 560234



### Lamp details

max. 50W QR111

Variant	Item No.
G53   QR111	
■ glossy black	139110
G53   QR111	
□ glossy white	139111
G53   QR111	
■ glossy chrome	139112

DURNO

NEW



LED INSIDE

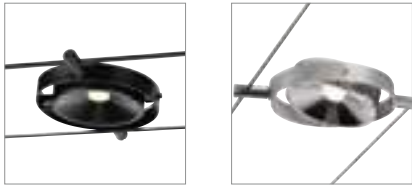

- Pivoting light head, individually alignable

Product details

12V ~50Hz  
 Total wattage: 6W  
 Material: aluminium/stainless steel



Dimensional drawing

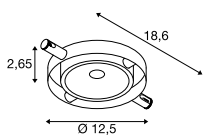

1002862 548

Variant	Item No.
360lm   2700K   CRI>80 ■ matt black	1002861
360lm   2700K   CRI>80 □ matt white	1002862
360lm   2700K   CRI>80 ■ chrome	1002863



1002864 549

PLYTTA



- Homogeneous light output

Product details

12V ~50Hz  
 Total wattage: 9W  
 Material: plastic/aluminium



120°

Dimensional drawing

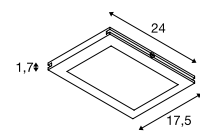

Variant	Item No.
580lm   2700K   CRI>80 ■ matt black	1002864
580lm   2700K   CRI>80 □ matt white	1002865
580lm   2700K   CRI>80 ■ chrome	1002866

**NOBLO SPOT**  
LV, Rope Track



1002695 550

**Product details**

12V ~50Hz  
Total wattage: 8.5W  
Material: aluminium/PMMA



**Dimensional drawing**

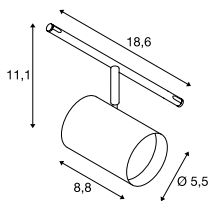

Variant	Item No.
420lm   2700K   CRI>80	
■ glossy black	1002694
450lm   2700K   CRI>80	
□ glossy white	1002695
450lm   2700K   CRI>80	
■ glossy chrome	1002696





1002690 551



139120 551

COMET  
LV, QR-C51

SOCKET  
INSIDE



COMET LED  
LV

LED  
INSIDE



• Frosted glass body

Product details

12V ~50Hz  
Material: brass/brass



Product details

12V ~50Hz  
Total wattage: 6.3W  
Material: aluminium/glass

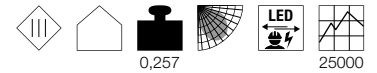

Dimensional drawing

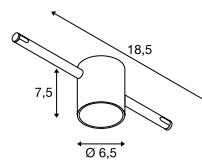

Dimensional drawing

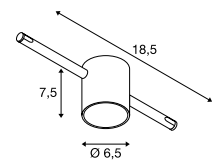

Recommended lamp

LED GU5.3 5,5W 36°  
2700K 450lm  
7kWh/1000h  
Item No. 1001574



LED GU5.3 5,5W 36°  
3000K 460lm  
7kWh/1000h  
Item No. 1001575



Lamp details

max. 50W QR-C51

Variant	Item No.
GU5.3   QR-C51 ■ glossy black/ frosted	139120
GU5.3   QR-C51 □ glossy white/ frosted	139121
GU5.3   QR-C51 ■ chrome	139122

Variant	Item No.
410lm   2700K   CRI>80 ■ glossy black/ frosted	1002688
410lm   2700K   CRI>80 □ glossy white/ frosted	1002689
410lm   2700K   CRI>80 ■ chrome/frosted	1002690

## COMPOSITION SCHEME

Cable system, wall-to-wall installation scheme (perpendicular to wall)

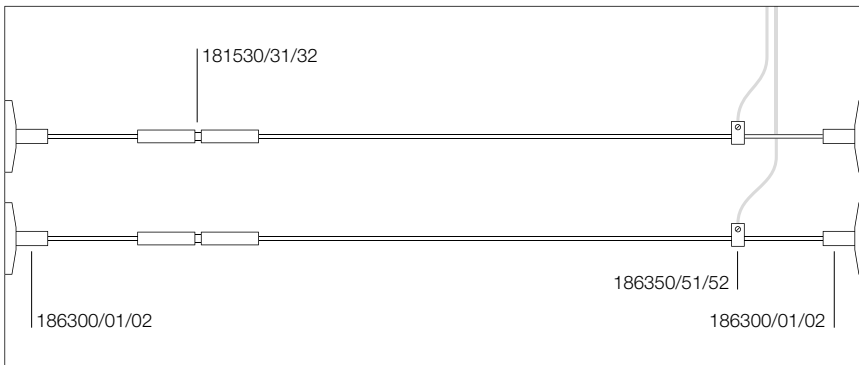

Items needed for this composition

Wall bracket	186300/01/02	x 2
Feed-in	186350/51/52	x 1
Wire tensioner	181530/31/32	x 1

Cable system wall-to-wall installation scheme, no cable tensioner (perpendicular to wall)

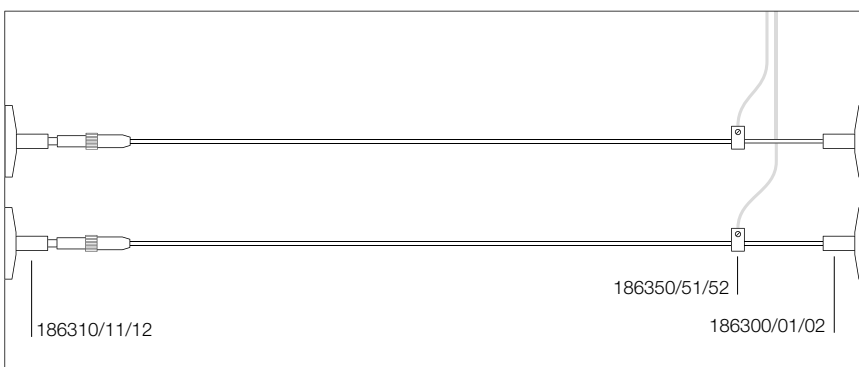

Items needed for this composition

Wall bracket	186300/01/02	x 1
Wall/ceiling bracket, flexible	186310/11/12	x 1
Feed-in	186350/51/52	x 1

Cable system wall-to-wall installation scheme, with changing in direction

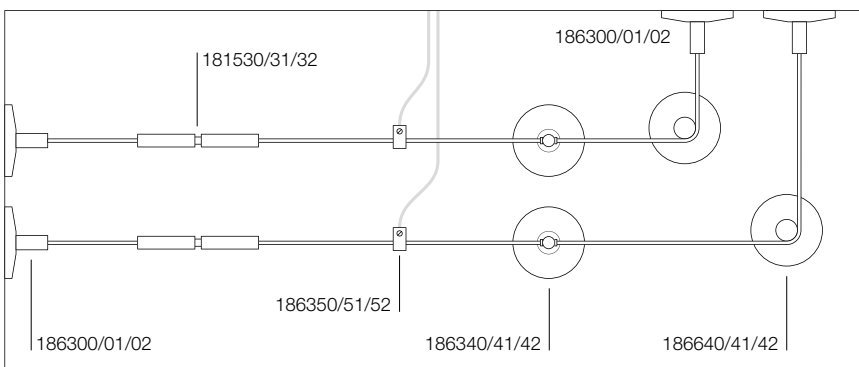

Items needed for this composition

Wall bracket	186300/01/02	x 2
Ceiling Deflector*	186640/41/42	x 1
Ceiling bracket	186340/41/42	x 1
Wire tensioner	181530/31/32	x 1
Feed-in	186350/51/52	x 1

\*Attention: deflectors don't work as support. Please select a suitable ceiling bracket to anchor the system to the ceiling.

Cable system wall-to-wall installation scheme (walls NOT perpendicular to the cable system)

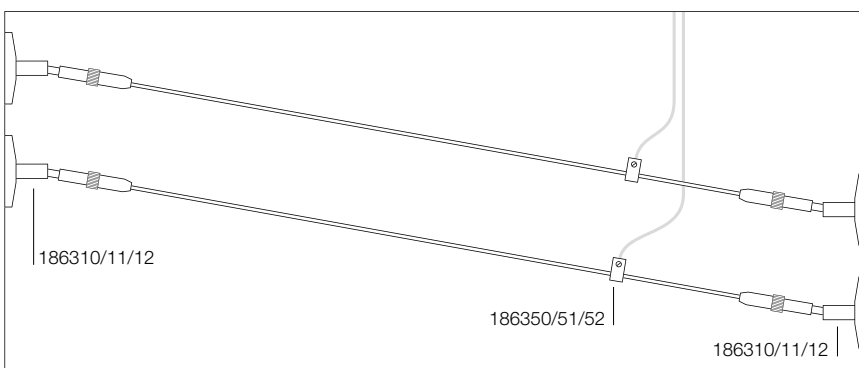

Items needed for this composition

Wall/ceiling bracket, flexible	186310/11/12	x 2
Feed-in	186350/51/52	x 1





## COMPOSITION SCHEME

Cable system wall-to-wall installation scheme, double switch

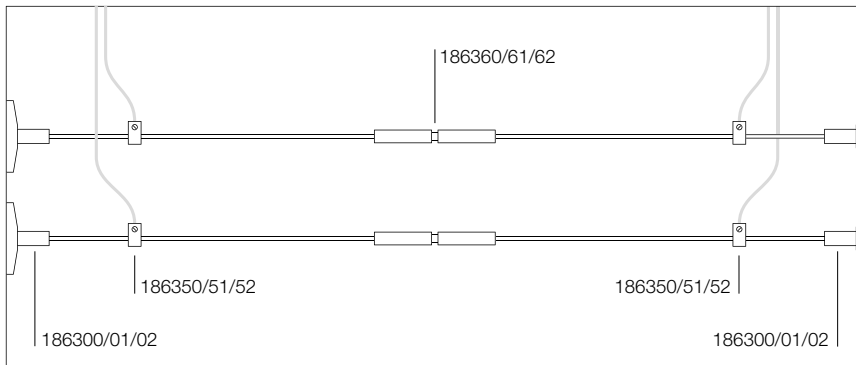

Items needed for this composition

Wall bracket	186300/01/02	x 2
Insulating connector	186360/61/62	x 1
Wire tensioner	181530/31/32	x 1
Feed-in	186350/51/52	x 2

Cable system wall-to-ceiling installation scheme

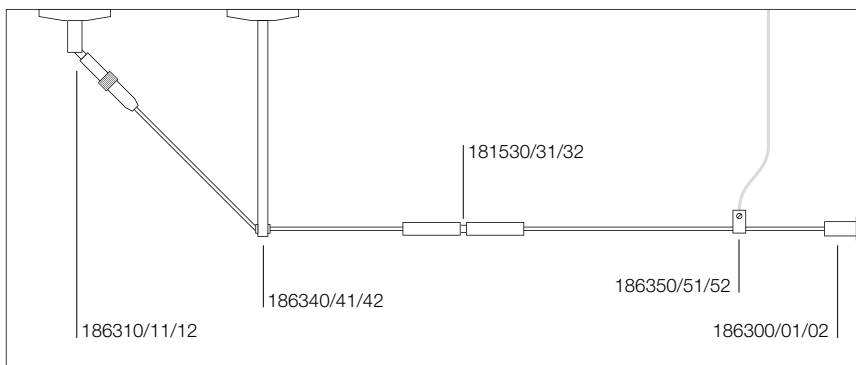

Items needed for this composition

Wall bracket	186300/01/02	x 1
Wall/ceiling bracket, flexible	186310/11/12	x 1
Wire tensioner	181530/31/32	x 1
Ceiling bracket, 16cm	186340/41/42	x 1
Feed-in	186350/51/52	x 1

Cable system ceiling-to-ceiling installation scheme

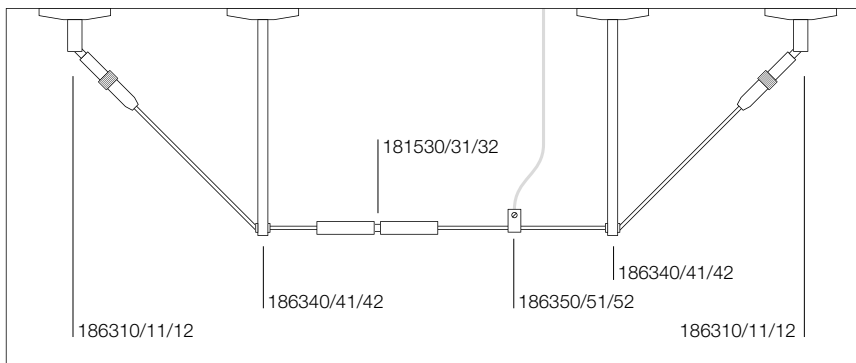

Items needed for this composition

Wall/ceiling bracket, flexible	186310/11/12	x 2
Wire tensioner	181530/31/32	x 1
Ceiling bracket, 16cm	186340/41/42	x 2
Feed-in	186350/51/52	x 1

## Note

All accessories are sold in 2 pieces per item number.  
The price is referred to a two pieces package.

The low-voltage cable is covered with insulating sheath.

Please use only our 12V transformers.

Low-voltage cable  
4mm<sup>2</sup>, 10m



TENSEO  
4mm<sup>2</sup>, 10m

TENSEO  
4mm<sup>2</sup>, 10m

TENSEO  
4mm<sup>2</sup>, 10m

Max. voltage	48V	48V	48V
Max perm. current	25A	25A	25A
Material	Copper/plastic	Copper/plastic	Copper/plastic
Colour	black	white	transparent
Diameter	0.4cm	0.4cm	0.4cm
Length	1,000cm	1,000cm	1,000cm
Weight	0.48kg	0.48kg	0.48kg
<b>Item No.</b>	<b>1002602</b>	<b>1002603</b>	<b>1002604</b>

Low-voltage cable  
4mm<sup>2</sup>, 20m



TENSEO  
4mm<sup>2</sup>, 20m

TENSEO  
4mm<sup>2</sup>, 20m

TENSEO  
4mm<sup>2</sup>, 20m

Max. voltage	48V	48V	48V
Max perm. current	25A	25A	25A
Material	Copper/plastic	Copper/plastic	Copper/plastic
Colour	black	white	transparent
Diameter	0.4cm	0.4cm	0.4cm
Length	2,000cm	2,000cm	2,000cm
Weight	0.88kg	0.88kg	0.85kg
<b>Item No.</b>	<b>139030</b>	<b>139031</b>	<b>139024</b>

Low-voltage cable  
4mm<sup>2</sup>, 100m



TENSEO  
4mm<sup>2</sup>, 100m

TENSEO  
4mm<sup>2</sup>, 100m

TENSEO  
4mm<sup>2</sup>, 100m

Max. voltage	48V	48V	48V
Max perm. current	25A	25A	25A
Material	Copper/plastic	Copper/plastic	Copper/plastic
Colour	black	white	transparent
Diameter	0.4cm	0.4cm	0.4cm
Length	10,000cm	10,000cm	10,000cm
Weight	4.4kg	4.4kg	4.26kg
<b>Item No.</b>	<b>139040</b>	<b>139041</b>	<b>139004</b>

Low-voltage cable  
6mm<sup>2</sup>, 20m



TENSEO  
6mm<sup>2</sup>, 20m

TENSEO  
6mm<sup>2</sup>, 20m

TENSEO  
6mm<sup>2</sup>, 20m

Max. voltage	48V	48V	48V
Max perm. current	25A	25A	25A
Material	Copper/plastic	Copper/plastic	Copper/plastic
Colour	black	white	transparent
Diameter	0.4cm	0.4cm	0.4cm
Length	2,000cm	2,000cm	2,000cm
Weight	1.23kg	1.23kg	1.21kg
<b>Item No.</b>	<b>139050</b>	<b>139051</b>	<b>139026</b>

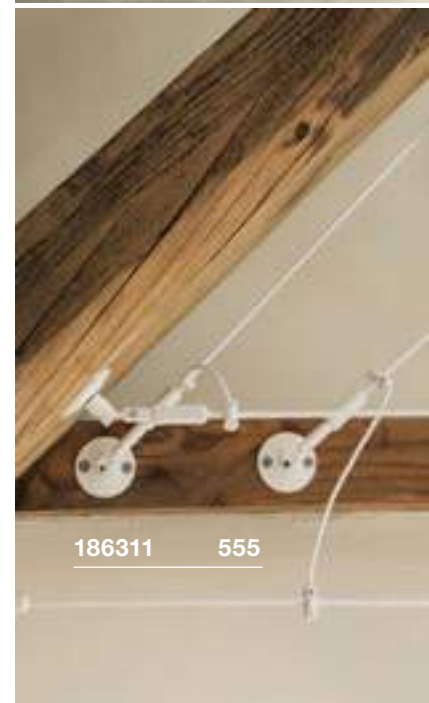

Low-voltage cable  
6mm<sup>2</sup>, 100m



	TENSEO 6mm <sup>2</sup> , 100m	TENSEO 6mm <sup>2</sup> , 100m	TENSEO 6mm <sup>2</sup> , 100m
Max. voltage	48V	48V	48V
Max perm. current	25A	25A	25A
Material	Copper/plastic	Copper/plastic	Copper/plastic
Colour	black	white	transparent
Diameter	0.4cm	0.4cm	0.4cm
Length	10,000cm	10,000cm	10,000cm
Weight	6.1kg	6.1kg	6kg
<b>Item No.</b>	<b>139060</b>	<b>139061</b>	<b>139006</b>

## ACCESSORIES FOR LOW-VOLTAGE CABLE SYSTEM TENSEO

### TRANSFORMER 12V AC | 50VA conventional

Steel/brass  
Diameter: 11.1cm H: 11cm  
Weight: 1.88kg  
1 piece



Variant	Item No.
■ glossy black	1002691
□ glossy white	1002692
■ chrome	1002693

### Wall bracket

Steel/brass  
Diameter: 5 cm H: 11.5 cm  
Weight: 0.08kg  
2 pieces



Variant	Item No.
■ glossy black	186310
□ glossy white	186311
■ chrome	186312

### Ceiling deflector

Steel/brass  
Diameter: 5cm H: 16cm  
Weight: 0.39kg  
2 pieces



Variant	Item No.
■ glossy black	186640
□ glossy white	186641
■ chrome	186642

### Transformer 12V | 105VA conventional

Steel/brass  
Diameter: 11cm H: 11cm  
Weight: 1.6kg  
1 piece



Variant	Item No.
■ glossy black	138980
□ glossy white	138981
■ chrome	138982

### Ceiling bracket 6cm

Steel/brass  
Diameter: 5cm H: 6cm  
Weight: 0.05kg  
2 pieces



Variant	Item No.
■ glossy black	186330
□ glossy white	186331
■ chrome	186332

### Suspension kit 2m

Steel/aluminium  
Diameter: 1.25cm W: 18.6cm  
Weight: 0.162kg  
1 piece



Variant	Item No.
■ glossy black	1002697
□ glossy white	1002698
■ chrome	1002699

### Transformer 12V | 21VA conventional

Steel/brass  
Diameter: 13.5cm H: 11cm  
Weight: 3.05kg  
1 piece



Variant	Item No.
■ glossy black	138990
□ glossy white	138991
■ chrome	138992

### Ceiling bracket

Steel/brass  
Diameter: 5cm H: 16cm  
Weight: 0.12kg  
2 pieces



Variant	Item No.
■ glossy black	186340
□ glossy white	186341
■ chrome	186342

### Spacer

aluminium  
Diameter: 1.25cm W: 9cm  
Weight: 0.35kg  
2 pieces



Variant	Item No.
■ glossy black	1002700
□ glossy white	1002701
■ chrome	1002702

### Wire tensioner

25A max.  
Brass  
Diameter: 1cm H: 11cm  
Weight: 0.04kg  
2 pieces



Variant	Item No.
■ glossy black	181530
□ glossy white	181531
■ chrome	181532

### Feed-in

25A max.  
Brass  
Diameter: 1cm H: 1.8cm  
Weight: 0.04kg  
2 pieces



Variant	Item No.
■ glossy black	186350
□ glossy white	186351
■ chrome	186352

### Spacer with connector

25A max.  
Brass  
Diameter: 1.25cm W: 9cm  
Weight: 0.82kg  
2 pieces



Variant	Item No.
■ glossy black	1002703
□ glossy white	1002704
■ chrome	1002705

### Wall bracket

Steel/brass  
Diameter: 5cm L: 3cm  
Weight: 0.05kg  
2 pieces



Variant	Item No.
■ glossy black	186300
□ glossy white	186301
■ chrome	186302

### Insulating connector

25A max.  
Aluminium/plastic  
Diameter: 1cm L: 6.4cm  
Weight: 0.04kg  
2 pieces



Variant	Item No.
■ glossy black	186360
□ glossy white	186361
■ chrome	186362

M-TRACK  
adjustable



- Easily to moved due to magnetic holder

Product details

12V DC  
Total wattage: 4.8W  
Material: aluminium/polycarbonate (PC)

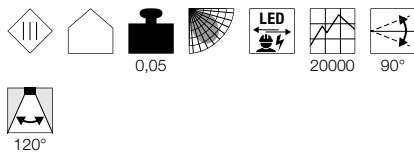

Dimensional drawing

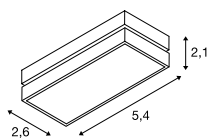

M-TRACK  
Spot

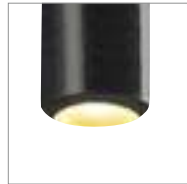

- Easily to moved due to magnetic holder

Product details

12V DC  
Total wattage: 7W  
Material: aluminium/polycarbonate (PC)

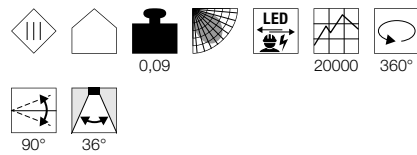

Dimensional drawing

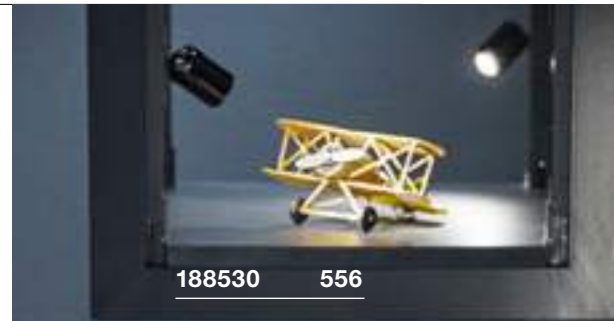
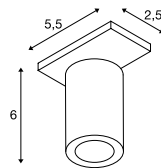

Variant	Item No.
260lm   3000K   CRI>80 ■ glossy black	188550

Variant	Item No.
400lm   3000K   CRI>80 ■ glossy black	188530



188550 556



188550 556



M-TRACK Track

Rated voltage	12V DC
Max. voltage	12V DC
Max perm. current	9A
Material	aluminium
Colour	glossy black
Length	200cm
Width	3cm
Height	1.4cm
Weight	1.05kg
<b>Item No.</b>	<b>188500</b>

<b>Feed-in</b>	
ABS/Polycarbonate (PC)	
L: 3.6cm W: 3cm H: 1.6cm	
Weight: 0.01kg	
1 piece	
<b>Variant</b>	<b>Item No.</b>
■ black	188510

<b>End cap</b>	
ABS/Polycarbonate (PC)	
L: 3cm W: 1.4cm H: 0.5cm	
Weight: 0.01kg	
1 piece	
<b>Variant</b>	<b>Item No.</b>
■ black	188520

<b>Recommended accessories</b>	
<input type="checkbox"/> LED power supply 12V DC   12W	
<b>Item No.</b>	470507



# SHOWING THE WAY.

## MOBILE LUMINAIRES AND FLOOR STANDS.

---

Nobody has to flounder in the dark any more: Mobile luminaires and floor stands are a popular design element for outdoor systems, and provide orientation and safety. The special appearance of the outdoor luminaires is due to their high-quality materials, modern designs and innovative technologies.





233437 559



1002958 599





MOBILE LIGHTS AND FLOOR LIGHTS

							
562	563	564	565	566	567	568	569
							
569	570	570	571	571	572	573	573
							
574	575	576	576	577	578	578	579
							
579	580	580	581	581	582	582	583
							
583	584	585	585	586	586	587	587
							
588	588	589	590	591	591	592	593
							
595	595	595	596	597	598	599	600
							
600	601	601	602	603	603	604	605
							
605	606	606	607	607	608	608	608
							
609	610	610	611	612	613	613	613

 Other luminaires and variants can be found online at [www.slv.com](http://www.slv.com)  
 You can find manufacturer's details for our recommended lamps in the chapter 'Lightbulbs', from page 844

PHOTONIA  
PD, E27



SOCKET  
INSIDE

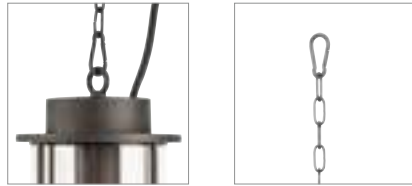

Product details

220-240V ~50/60Hz  
Material: aluminium/glass



Dimensional drawing

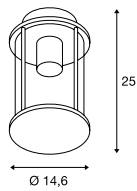

Tip

Suspension chain included

Accessory recommendation

■ Ceiling rose  
Item No. 1000398



Recommended lamp

LED E27 7.1W 330°  
2700K 806lm  
8kWh/1000h  
Item No. 1001756



LED E27 7W 280°  
2200-2700K 830lm  
7kWh/1000h  
Item No. 1002126



Lamp details

max. 60W  
Diameter: 9 cm max. L: 15 cm max.

Variant	Item No.
E27 ■ anthracite	232065



232065 562



232065 562

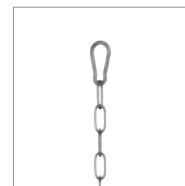

1000821 563

**MOLAT  
PD, E27****SOCKET  
INSIDE****Product details**

230V ~50/60Hz

Material: aluminium/glass



IP 44

1,6

250

500

IK04

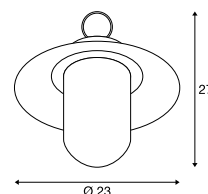
**Dimensional drawing****Tip**

Suspension chain included

**Accessory recommendation**

■ Ceiling rose

Item No. 1000398

**Recommended lamp**

LED E27 7.1W 330°

2700K 806lm

8kWh/1000h

Item No. 560741



LED E27 7W 280°

2700K 790lm

7kWh/1000h

Item No. 1002127

**Lamp details**

max. 60W

Diameter: 6.5 cm max. L: 14.5 cm max.

Variant	Item No.
E27	
■ anthracite	1000821

**KIROCONE**  
TL, E27

SOCKET  
INSIDE



**Product details**

230V -50Hz  
Material: steel/polycarbonate (PC)



**Dimensional drawing**

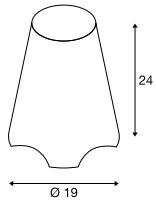

**Tip**

IP safety plug

**Recommended lamp**

LED E27 9.1W 240°  
2700K 760lm  
10kWh/1000h  
Item No. 560402



LED E27 7W  
2700K 810lm  
7kWh/1000h

Item No. 1003090



**Lamp details**

max. 60W  
Diameter: 9.5 cm max. L: 14.5 cm max.

Variant	Item No.
E27 □ white	1001778



1001778 564



1001778 564



227221 565



227221 565

ROTOBALL 25/40/50  
FL, E27



SOCKET  
INSIDE



- Harmonious design
- Even light distribution
- For the decorative illumination and aesthetic accentuation of indoor and outdoor areas

Product details

230V -50Hz  
Material: steel/polyethylene (PE)

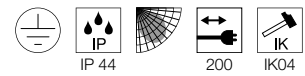

Dimensional drawing

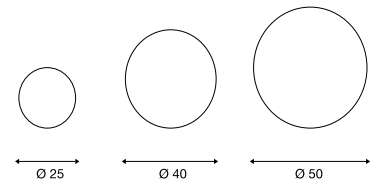

Tip

IP safety plug

Recommended lamp

LED E27 14.5W 200°  
2700K 1521lm  
15kWh/1000h  
Item No. 560422



LED E27 7W 280°  
2700K 790lm  
7kWh/1000h  
Item No. 1002127



Lamp details

max. 24 W  
Diameter: 9.5 cm max.

Variant	Item No.
E27   Diameter: 25 cm   1.05 kg	
<input type="checkbox"/> white	227219
E27   Diameter: 40 cm   2.2 kg	
<input type="checkbox"/> white	227220
E27   Diameter: 50 cm   3.12 kg	
<input type="checkbox"/> white	227221

ADEGAN MANILA  
FL, E27



SOCKET  
INSIDE

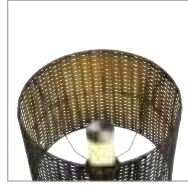

1002494 566

Product details

230V -50Hz  
Material: granite/stainless steel

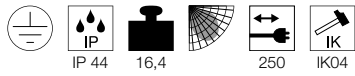

Dimensional drawing

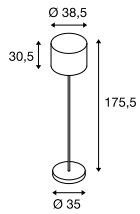

Tip

IP safety plug

Recommended lamp

LED E27 9W 240°  
3000K 810lm  
10kWh/1000h  
Item No. 1001031



LED E27 15W 240°  
3000K 1521lm  
15kWh/1000h  
Item No. 1001033



Lamp details

max. 15W  
Diameter: 4.8 cm max. L: 18 cm max.

Variant	Item No.
E27	
■ stainless steel/anthracite	1002494



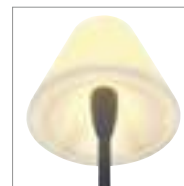

228965 567

**ADEGAN**  
FL, E27**SOCKET**  
**INSIDE**

- Mobile light
- Lightshade: extremely UV-resistant polycarbonate
- Feel-good lighting for every design style

**Product details**

220-240V ~50/60Hz

Material: aluminium/polycarbonate (PC)



IP 54



9



250

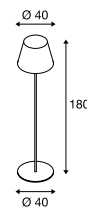

IK04

**Dimensional drawing****Tip**

IP contour plug

**Accessory recommendation**

■ Spike

Item No. 228960

**Recommended lamp**

LED E27 9W 240°

3000K 810lm

10kWh/1000h

Item No. 1001031



LED E27 15W 240°

3000K 1521lm

15kWh/1000h

Item No. 1001033

**Lamp details**

max. 24 W

Diameter: 5.2cm max.

Variant	Item No.
E27	
■ anthracite/white	228965

PHOTONIA  
TL, E27



SOCKET  
INSIDE



232095 568



- Ultra-long power cable with IP safety plug

Product details

220-240V ~50/60Hz  
Material: aluminium/glass



Dimensional drawing

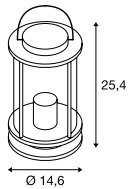

Tip

IP safety plug

Recommended lamp

LED E27 5W 330°  
2000K 500lm  
5kWh/1000h  
Item No. 560741



LED E27 7W 280°  
2700K 790lm  
7kWh/1000h  
Item No. 1002124



Lamp details

max. 60W  
Diameter: 9 cm max. L: 15 cm max.

Variant	Item No.
E27 ■ anthracite	232095



132832 569





230435 569

**CUBIX**  
FL, QPAR51

SOCKET  
INSIDE



- Mobile light

**Product details**

230V -50Hz  
Material: aluminium/glass



**Dimensional drawing**

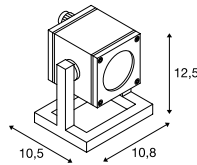

**Tip**

IP safety plug

**CONE**  
FL, E27

SOCKET  
INSIDE



**Product details**

220-240V ~50/60Hz  
Material: aluminium/glass

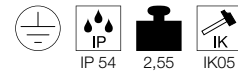

**Dimensional drawing**

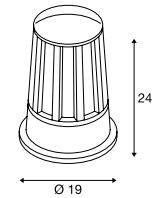

**Tip**

Material thickness of mounting surface: 20 mm

**Recommended lamp**

LED GU10 5.5W 38°  
2700K 400lm  
6kWh/1000h  
Item No. 1001030



LED GU10 4W 36°  
3000K 300lm  
4kWh/1000h  
Item No. 1004973



**Lamp details**

max. 25W QPAR51

Variant	Item No.
GU10   QPAR51	
■ grey	132832
GU10   QPAR51	
■ anthracite	132835

**Recommended lamp**

LED E27 14.5W 200°  
2700K 1521lm  
15kWh/1000h  
Item No. 560422



LED E27 7W 280°  
2700K 790lm  
7kWh/1000h  
Item No. 1002124



**Lamp details**

max. 100W  
L: 15 cm max.

Variant	Item No.
E27	
■ anthracite	230435

RUSTY® CONE 24  
FL, E14

SOCKET  
INSIDE



- Rusted steel
- Every light is a unique one-off
- Small path lights for driveways and gardens

Product details

230V -50Hz  
Material: FeCSi steel/polycarbonate (PC)

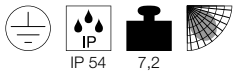

Dimensional drawing

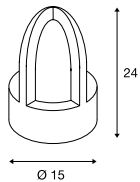

Recommended lamp

LED E14 4,5W 280°  
2700K 470lm  
5kWh/1000h  
Item No. 1002128



LED E14 6,5W 280°  
3000K 480lm  
7kWh/1000h  
Item No. 560372



Lamp details

max. 40W C35  
Diameter: 4.8 cm max. L: 13.9 cm max.

Variant	Item No.
E14   C35 rust	229430

RUSTY® CONE 40/70  
Pole, E27

SOCKET  
INSIDE



- Rusted steel
- Every light is a unique one-off

Product details

230V -50Hz  
Material: FeCSi steel/polycarbonate (PC)

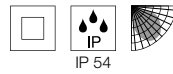

Dimensional drawing

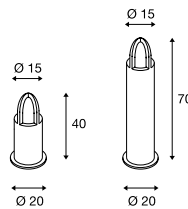

Accessory recommendation

- Connection box IP68, 3-pole  
Item No. 228730
- Spike  
Item No. 229423



Recommended lamp

LED E27 9W 240°  
3000K 810lm  
10kWh/1000h  
Item No. 1001031



Lamp details

max. 11W  
Diameter: 4.8 cm max. L: 13.9 cm max.

Variant	Item No.
E27   H: 40 cm   12.2 kg rust	229431
E27   H: 70 cm   18.8 kg rust	229432

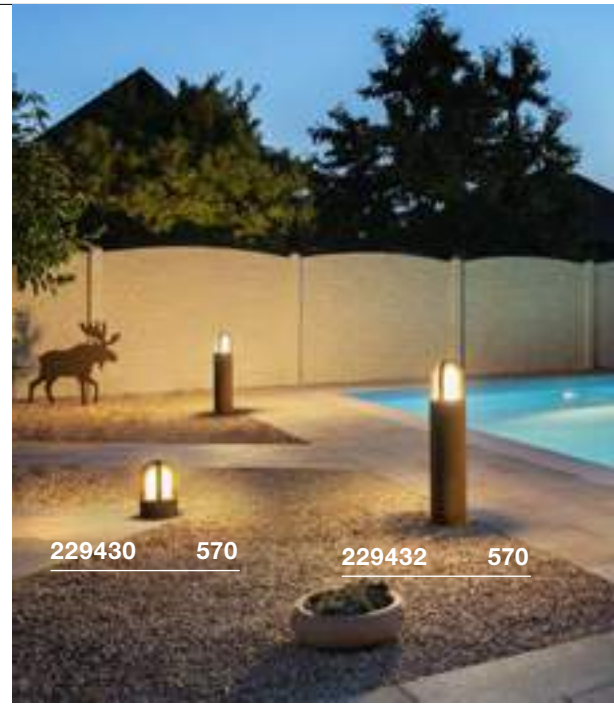

229430 570

229432 570

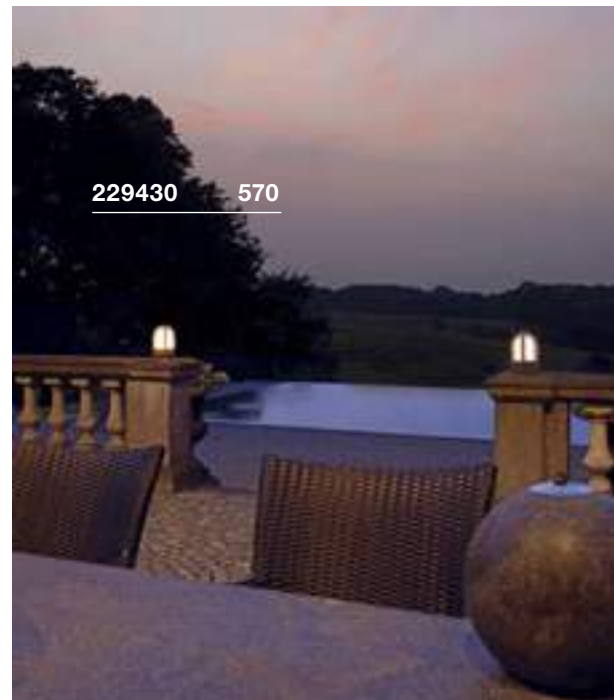

229430 570



229431 570



229021 571



229020 571

### RUSTY® 40/70 Pole, E27

SOCKET  
INSIDE



- Rusted steel
- Every light is a unique one-off

#### Product details

230V -50Hz  
Material: FeCSi steel/polycarbonate (PC)

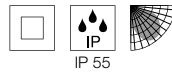

#### Dimensional drawing

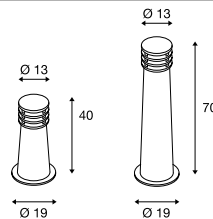

#### Accessory recommendation

- Connection box IP68, 3-pole  
Item No. 228730
- Spike  
Item No. 229022

#### Recommended lamp

LED E27 9W 240°  
3000K 810lm  
10kWh/1000h  
Item No. 1001031

LED E27 9W 240°  
4000K 850lm  
9kWh/1000h  
Item No. 1002827

#### Lamp details

max. 11W  
Diameter: 4.8 cm max. L: 13.9 cm max.

Variant	Item No.
E27   H: 40 cm   11 kg ■ rust	229020
E27   H: 70 cm   17.5 kg ■ rust	229021

### RUSTY® 40/70 Pole

LED  
INSIDE



- Rusted steel
- Every light is a unique one-off
- High-voltage LED

#### Product details

220-240V ~50/60Hz  
Total wattage: 8.6W  
Material: FeCSi steel/polycarbonate (PC)

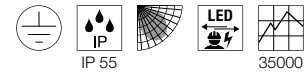

#### Dimensional drawing

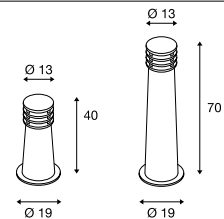

#### Tip

Open cable end

#### Accessory recommendation

- Connection box IP68, 3-pole  
Item No. 228730
- Spike  
Item No. 229022

Variant	Item No.
70lm   3000K   CRI>80   H: 40 cm   11 kg ■ rust	233407
70lm   3000K   CRI>80   H: 70 cm   17.5 kg ■ rust	233417

LISENNE 40/70  
Pole, E27



SOCKET  
INSIDE



- Basalt stone & smoked glass
- Smoked glass has a mirrored appearance when switched off

Product details

230V ~50/60Hz  
Material: basalt/glass

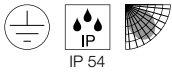

Dimensional drawing

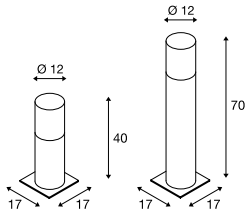

Accessory recommendation

■ Spike  
Item No. 229422



Recommended lamp

LED E27 7.1W 330°  
2700K 806lm  
8kWh/1000h  
Item No. 1001756



Lamp details

max. 23 W  
Diameter: 5.9 cm max. L: 15 cm max.

Variant	Item No.
E27   H: 40 cm   5,65 kg	
■ grey/brown	1000665
E27   H: 70 cm   12,4 kg	
■ grey/brown	1000666



1000665 572



232075 573



230465 573

**PHOTONIA**  
Pole, E27



**OTOS GLAS**  
Pole, E27

SOCKET  
INSIDE

SOCKET  
INSIDE



**Product details**

220-240V ~50/60Hz  
Material: aluminium/glass

**Product details**

230V -50Hz  
Material: aluminium/glass

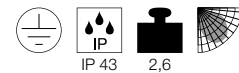

**Dimensional drawing**

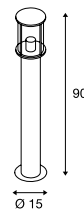

**Dimensional drawing**

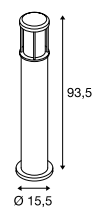

**Tip**

Open cable end

**Accessory recommendation**

- Concrete anchor  
Item No. 232085
- Connection box IP68, 3-pole  
Item No. 228730

- Screw set  
Item No. 228753
- Connection box IP68, 3-pole  
Item No. 228730

**Recommended lamp**

LED E27 5W 330°  
2000K 500lm  
5kWh/1000h  
Item No. 560741



LED E27 7.1W 330°  
2700K 806lm  
8kWh/1000h  
Item No. 1001756



**Recommended lamp**

LED E27 14.5W 200°  
2700K 1521lm  
15kWh/1000h  
Item No. 560422



LED E27 7W 280°  
2700K 790lm  
7kWh/1000h  
Item No. 1002124



**Lamp details**

max. 60W  
Diameter: 9 cm max. L: 15 cm max.

**Lamp details**

max. 15W  
Diameter: 6.5 cm max. L: 14.5 cm max.

Variant	Item No.
E27	
■ anthracite	232075

Variant	Item No.
E27	
■ anthracite	230465

GLOO PURE 27/44/70  
Pole, E27



SOCKET  
INSIDE

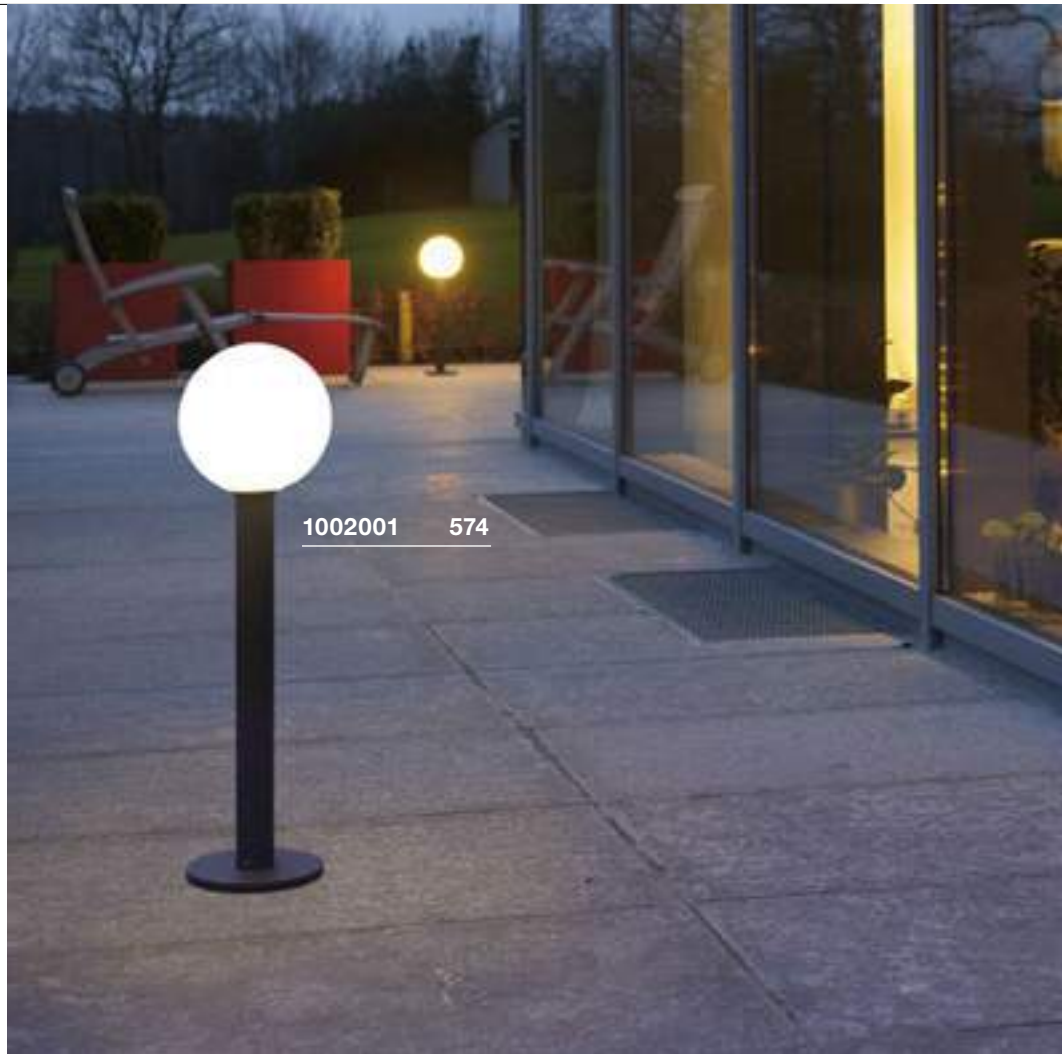

1002001 574

Product details

230V -50Hz  
Material: aluminium/glass

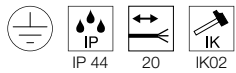

Dimensional drawing

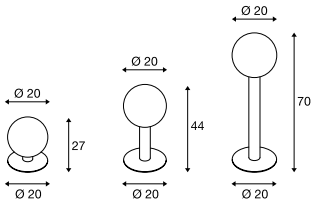

Tip

Open cable end

Accessory recommendation

■ Connection box IP68, 3-pole  
Item No. 228730



■ Spike

Item No. 231234



Recommended lamp

LED E27 9W 240°  
3000K 810lm  
10kWh/1000h  
Item No. 1001031



LED E27 15W 240°  
3000K 1521lm  
15kWh/1000h  
Item No. 1001033



Lamp details

max. 23 W  
Diameter: 4.8 cm max. L: 18 cm max.

Variant	Item No.
E27   H: 27 cm   1.5 kg ■ anthracite/white	1001999
E27   H: 44 cm   1.7 kg ■ anthracite/white	1002000
E27   H: 70 cm   1.9 kg ■ anthracite/white	1002001



1001999 574



1004680 575



1004681 575

OVALISK 75/100  
Pole



- The light colour can be selected during installation using a switch

Product details

100-240V ~50/60Hz | 500mA  
System output: 9W  
Material: aluminium/glass



IP 65

IK02

Dimensional drawing

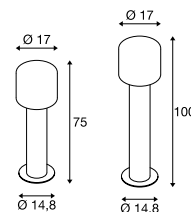

Accessory recommendation

- Connection box IP68, 3-pole  
Item No. 228730
- Spike  
Item No. 228722
- Concrete anchor  
Item No. 228712



Variant	Item No.
560/600lm   3000/4000K   CRI>80 H: 75 cm   3.0 kg	■ matt anthracite 1004680
560/600lm   3000/4000K   CRI>80 H: 100 cm   3.5 kg	■ matt anthracite 1004681

**ALPA CONE 100**  
Pole, E27

SOCKET  
INSIDE



**ALPA MUSHROOM 45/75**  
Pole, E27

SOCKET  
INSIDE



**Product details**

220-240V ~50/60Hz  
Material: aluminium/polycarbonate (PC)

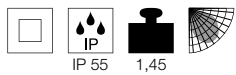

**Dimensional drawing**

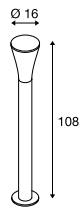

**Tip**

Open cable end

**Accessory recommendation**

- Connection box IP68, 3-pole  
Item No. 228730
- Spike  
Item No. 228722
- Concrete anchor  
Item No. 228712



**Recommended lamp**

LED E27 9W 240°  
4000K 850lm  
9kWh/1000h  
Item No. 1002827



LED E27 15W 240°  
4000K 1600lm  
15kWh/1000h  
Item No. 1002828



**Lamp details**

max. 24 W  
Diameter: 5.2 cm max. L: 17.5 cm max.

Variant	Item No.
E27	
■ grey	228922
E27	
■ anthracite	228925

**Product details**

220-240V ~50/60Hz  
Material: aluminium/polycarbonate (PC)

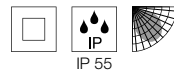

**Dimensional drawing**

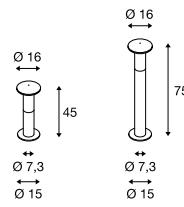

**Tip**

Open cable end

**Accessory recommendation**

- Connection box IP68, 3-pole  
Item No. 228730
- Spike  
Item No. 228722
- Concrete anchor  
Item No. 228712



**Recommended lamp**

LED E27 9W 240°  
3000K 810lm  
10kWh/1000h  
Item No. 1001031



LED E27 15W 240°  
3000K 1521lm  
15kWh/1000h  
Item No. 1001033



**Lamp details**

max. 24 W  
Diameter: 5.2 cm max. L: 16 cm max.

Variant	Item No.
E27   H: 45 cm   0.9 kg	
■ anthracite	228935
E27   H: 75 cm   2 kg	
■ anthracite	228945







1000682 577



1000682 577

APONI 90/120  
Pole, PHASE

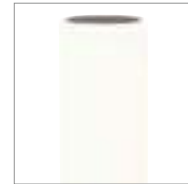

- High-voltage LED

Product details

220-240V ~50/60Hz  
Total wattage: 8W  
Material: aluminium  
Dimmable: L



IP 65

20

30000

Dimensional drawing

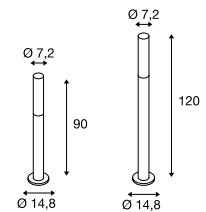

Tip

Open cable end

Accessory recommendation

■ Connection box IP68, 3-pole  
Item No. 228730



Variant	Item No.
440lm   3000K   CRI>80   H: 90 cm   1.4 kg ■ anthracite	1000682
440lm   3000K   CRI>80   H: 120 cm   1.75 kg ■ anthracite	1000683

**LIGHT PIPE 60/90/140**  
Pole, PHASE



- Suitable for indoor and outdoor use

**Product details**

220-240V ~50/60Hz  
Total wattage: 11W  
Material: aluminium/polymethylacrylate (PMMA)  
Dimmable: C, L

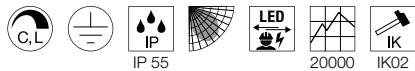

**Dimensional drawing**

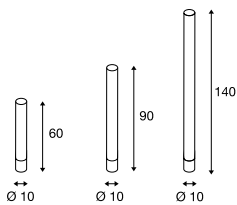

**Tip**

The lights are delivered without a mounting plate  
Indoor mounting plate with foot switch located on the power cord  
Outdoor mounting plate without switch  
IP 44 safety plug

**Accessory recommendation**

- Spike  
Item No. 234430
- Mounting plate outdoor  
Item No. 234431
- Mounting plate indoor  
Item No. 234441

Variant	Item No.
630lm   2700K   CRI>80   H: 60 cm   1.5 kg white	234401
630lm   2700K   CRI>80   H: 90 cm   1.71 kg white	234411
630lm   2700K   CRI>80   H: 140 cm   2.06 kg white	234421

**MOLAT**  
Pole, E27



- Suitable for indoor and outdoor use

**Product details**

230V ~50/60Hz  
Material: aluminium/glass



**Dimensional drawing**

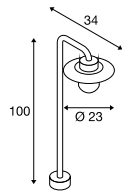

**Accessory recommendation**

- Spike  
Item No. 230060

**Recommended lamp**

- LED E27 7.1W 330°  
2700K 806lm  
8kWh/1000h  
Item No. 560741
- LED E27 7.1W 330°  
2700K 806lm  
8kWh/1000h  
Item No. 1001756

**Lamp details**

max. 60W  
Diameter: 6.5 cm max. L: 14.5 cm max.

Variant	Item No.
E27 anthracite	1000822



234411 578



1000822 578



228110 579



231602 579

### TRUST 30/60 Pole

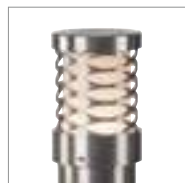

- Stainless steel 316
- High-voltage LED
- Slim path lights for versatile outdoor designs

#### Product details

220-240V ~50/60Hz  
Total wattage: 8.6W  
Material: stainless steel 316

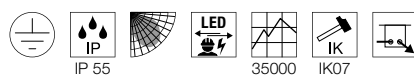

#### Dimensional drawing

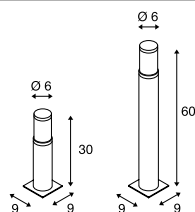

#### Accessory recommendation

- Connection box IP68, 3-pole  
Item No. 228730
- Spike  
Item No. 227922
- Grid spiral-shaped  
Item No. 1000449
- Ring-shaped grid  
Item No. 228130

### BIG NAILS PLUS 50/80 Pole, E27



- Stainless steel 304

#### Product details

230V -50Hz  
Material: stainless steel 304/acrylic

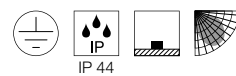

#### Dimensional drawing

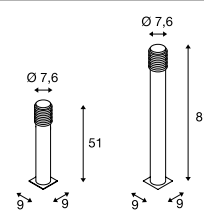

#### Accessory recommendation

- Connection box IP68, 3-pole  
Item No. 228730
- Spike  
Item No. 227922

#### Recommended lamp

- LED E27 9W 240°  
3000K 810lm  
10kWh/1000h  
Item No. 1001031
- LED E27 15W 240°  
4000K 1600lm  
15kWh/1000h  
Item No. 1002828

#### Lamp details

max. 23 W  
Diameter: 4.8 cm max. L: 1.48 cm max.

Variant	Item No.
400lm   3000K   CRI>80   H: 30 cm   1.4 kg ■ stainless steel	228100
400lm   3000K   CRI>80   H: 60,5 cm   2.25 kg ■ stainless steel	228110

Variant	Item No.
E27   H: 50 cm   1.13 kg ■ stainless steel	231602
E27   H: 80 cm   1.54 kg ■ stainless steel	231612

**BIG NAILS 50/80**  
Pole



**BIG NAILS 50/80**  
Pole, E27



- Stainless steel 304
- Slim path lights for versatile outdoor designs

**Product details**

230V -50Hz  
Total wattage: 8.5W  
Material: stainless steel 316

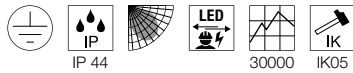

**Product details**

230V -50Hz  
Material: stainless steel 304/polycarbonate (PC)

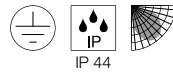

**Dimensional drawing**

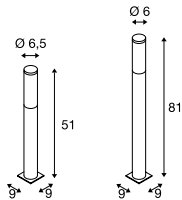

**Dimensional drawing**

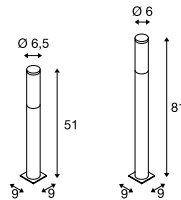

**Accessory recommendation**

■ Spike  
Item No. 227922



**Accessory recommendation**

■ Spike  
Item No. 227922



**Recommended lamp**

LED E27 9W 240°  
3000K 810lm  
10kWh/1000h  
Item No. 1001031



LED E27 9W 240°  
4000K 850lm  
9kWh/1000h  
Item No. 1002827



**Lamp details**

max. 15W  
Diameter: 4.5 cm max. L: 17 cm max.

Variant	Item No.
480lm   3000K   CRI>80   H: 50 cm   0.9 kg ■ stainless steel	1001997
480lm   3000K   CRI>80   H: 80 cm   1.235 kg ■ stainless steel	1001998

Variant	Item No.
E27   H: 51 cm   1.1 kg ■ stainless steel	229162
E27   H: 81 cm   1.6 kg ■ stainless steel	229172



229162 580



1001998 580



1001491 581



1001493 581

ROX ACRYL 30/60/90 Pole, PHASE



Product details

220-240V ~50/60Hz  
Total wattage: 12W  
Material: stainless steel 316  
Dimmable: C, L

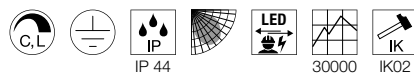

Dimensional drawing

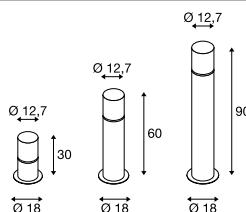

Accessory recommendation

- T-connector box  
Item No. 228726
- Concrete anchor  
Item No. 1001494
- Spike  
Item No. 231234

Variant	Item No.
690lm   3000K   CRI>80   H: 30 cm   1.55 kg	1001491
690lm   3000K   CRI>80   H: 60 cm   2.55 kg	1001492
690lm   3000K   CRI>80   H: 90 cm   3.45 kg	1001493

ROX ACRYL 30/60/90 Pole, E27



• High-quality brushed surface

Product details

220-240V ~50/60Hz  
Material: stainless steel 304



Dimensional drawing

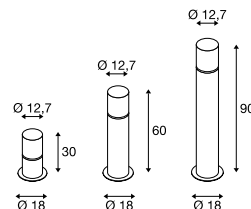

Accessory recommendation

- T-connector box  
Item No. 228726
- Concrete anchor  
Item No. 1001494
- Spike  
Item No. 231234

Recommended lamp

- LED E27 14.5W 200°  
2700K 1521lm  
15kWh/1000h  
Item No. 560422
- LED E27 7W  
2700K 810lm  
7kWh/1000h  
Item No. 1003090

Lamp details

max. 20W  
Diameter: 6 cm max. L: 15 cm max.

Variant	Item No.
E27   H: 30 cm   1.1 kg	1001488
E27   H: 60 cm   2.1 kg	1001489
E27   H: 90 cm   3 kg	1001490

VAP SLIM 30/60/90  
Pole, E27

SOCKET  
INSIDE



- Stainless steel 304
- Slim path lights for versatile outdoor designs

Product details

230V -50Hz  
Material: stainless steel 304



Dimensional drawing

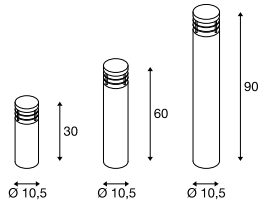

Accessory recommendation

- Spike  
Item No. 230060
- Concrete anchor  
Item No. 230061

Recommended lamp

- LED E27 9W 240°  
3000K 810lm  
10kWh/1000h  
Item No. 1001031
- LED E27 9W 240°  
4000K 850lm  
9kWh/1000h  
Item No. 1002827

Lamp details

max. 20W  
Diameter: 5 cm max. L: 12.6 cm max.

Variant	Item No.
E27   H: 30 cm   1.5 kg ■ stainless steel	230063
E27   H: 60 cm   2.5 kg ■ stainless steel	230066
E27   H: 90 cm   3.4 kg ■ stainless steel	230069

VAP 40/70/100  
Pole, E27

SOCKET  
INSIDE



- Stainless steel 304

Product details

230V -50Hz  
Material: stainless steel 304

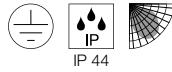

Dimensional drawing

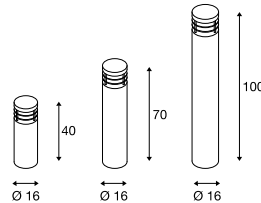

Accessory recommendation

- Connection box IP68, 3-pole  
Item No. 228730
- Concrete anchor  
Item No. 229059

Recommended lamp

- LED E27 9W 240°  
3000K 810lm  
10kWh/1000h  
Item No. 1001031
- LED E27 9W 240°  
4000K 850lm  
9kWh/1000h  
Item No. 1002827

Lamp details

max. 23 W  
Diameter: 5.2 cm max. L: 12.1 cm max.

Variant	Item No.
E27   H: 40 cm   4.4 kg ■ stainless steel	229054
E27   H: 70 cm   6 kg ■ stainless steel	229057
E27   H: 100 cm   7.6 kg ■ stainless steel	229050



229054 582



230066 582



231595 583



231475 583

F-POL Pole, E27



SOCKET INSIDE



C-POL Pole, E27



SOCKET INSIDE

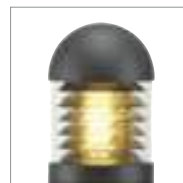

Product details

230V -50Hz  
Material: aluminium/polycarbonate (PC)

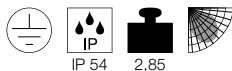

Dimensional drawing

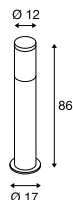

Accessory recommendation

■ Connection box IP68, 3-pole  
Item No. 228730



Recommended lamp

LED E27 9W 240°  
3000K 810lm  
10kWh/1000h  
Item No. 1001031



LED E27 15W 240°  
3000K 1521lm  
15kWh/1000h  
Item No. 1001033



Lamp details

max. 20W  
Diameter: 5 cm max. L: 14.8 cm max.

Variant	Item No.
E27	
■ anthracite	231595

Product details

230V -50Hz  
Material: aluminium/polycarbonate (PC)

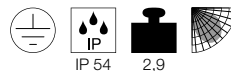

Dimensional drawing

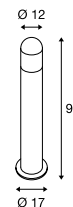

Accessory recommendation

■ Connection box IP68, 3-pole  
Item No. 228730



Recommended lamp

LED E27 9W 240°  
3000K 810lm  
10kWh/1000h  
Item No. 1001031



LED E27 15W 240°  
3000K 1521lm  
15kWh/1000h  
Item No. 1001033



Lamp details

max. 24 W  
Diameter: 5.2 cm max. L: 17.3 cm max.

Variant	Item No.
E27	
■ anthracite	231475

POLE PARC 90/150/200  
Pole



- Technical lighting system for targeted floor illumination
- Even, rotationally-symmetrical light distribution
- Modern design for subtle, glare-free lighting

Product details

100-240V ~50/60Hz | 1450mA  
Material: aluminium/plastic



Dimensional drawing

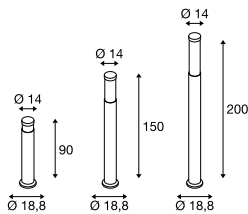

Accessory recommendation

■ Connection box IP68, 3-pole  
Item No. 228730



Variant	Item No.
1000lm   3000K   CRI>80 90 cm   5.2 kg   145mA   21W ■ anthracite	1000760
1800lm · 3000K · CRI>80 150 cm   8.3 kg   840mA   33W ■ anthracite	1000761
2600lm   3000K   CRI>80 200 cm   11.5 kg   1430mA   50W ■ anthracite	1000762



1000762 556



1000446 683

1000760 584





1004751 585

**ESKINA FRAME 45/75**  
Pole, single



- The light colour can be selected during installation using a switch

**Product details**

220-240V ~50/60Hz | 350mA  
System output: 15W  
Material: aluminium

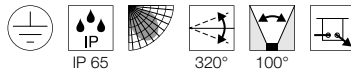

**Dimensional drawing**

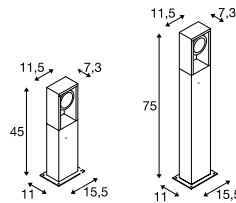

**ESKINA FRAME 75**  
Pole, double

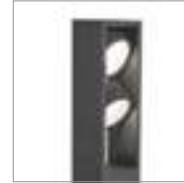

- The light colour can be selected during installation using a switch

**Product details**

220-240V ~50/60Hz | 700mA  
Total wattage: 27W  
Material: aluminium



**Dimensional drawing**

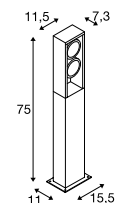

Variant	Item No.
1100/1200lm   3000/4000K   CRI>80 H: 45cm   2.3kg ■ matt anthracite	<b>1004749</b>
1100/1200lm   3000/4000K   CRI>80 H: 75cm   3.1kg ■ matt anthracite	<b>1004750</b>

Variant	Item No.
Spot 1: 1100/1200lm   3000/4000K   CRI>80 Spot 2: 1100/1200lm   3000/4000K   CRI>80 ■ matt anthracite	<b>1004751</b>

**GRAFIT 30/60**  
Pole, E27



**LOGS 40/70**  
Pole



SOCKET  
INSIDE

LED  
INSIDE



**Product details**

230V -50Hz  
Material: aluminium/plastic



**Product details**

100-240V ~50/60Hz | 500mA  
Total wattage: 8W  
Material: aluminium

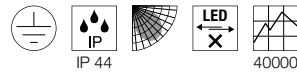

**Dimensional drawing**

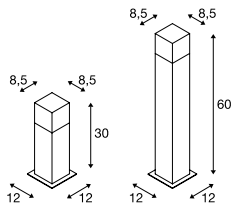

**Dimensional drawing**

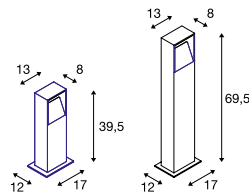

**Accessory recommendation**

- Screw set  
Item No. 228752 25
- Spike  
Item No. 231230



**Recommended lamp**

LED E27 14.5W 200°  
2700K 1521lm  
15kWh/1000h  
Item No. 560422



LED E27 7W  
2700K 810lm  
7kWh/1000h  
Item No. 1003090



**Lamp details**

max. 11W  
Diameter: 6 cm max. L: 11.5 cm max.

Variant	Item No.
E27   H: 30 cm   0.8 kg ■ anthracite	231215
E27   H: 60 cm   1.4 kg ■ anthracite	231225

**Accessory recommendation**

- Connection box IP68, 3-pole  
Item No. 228730
- Spike  
Item No. 231230
- Screw set  
Item No. 228754
- Concrete anchor  
Item No. 232119



Variant	Item No.
420lm   3000K   CRI>80   H: 39.5 cm   2 kg ■ anthracite	232115
420lm   3000K   CRI>80   H: 69.5 cm   2.8 kg ■ anthracite	232125



231225 586

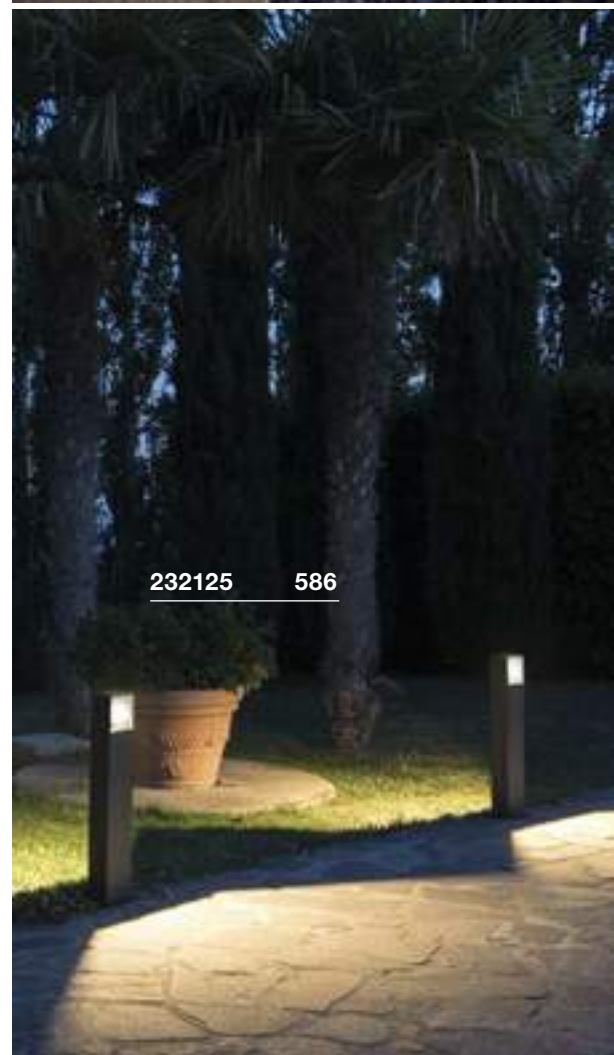

232125 586

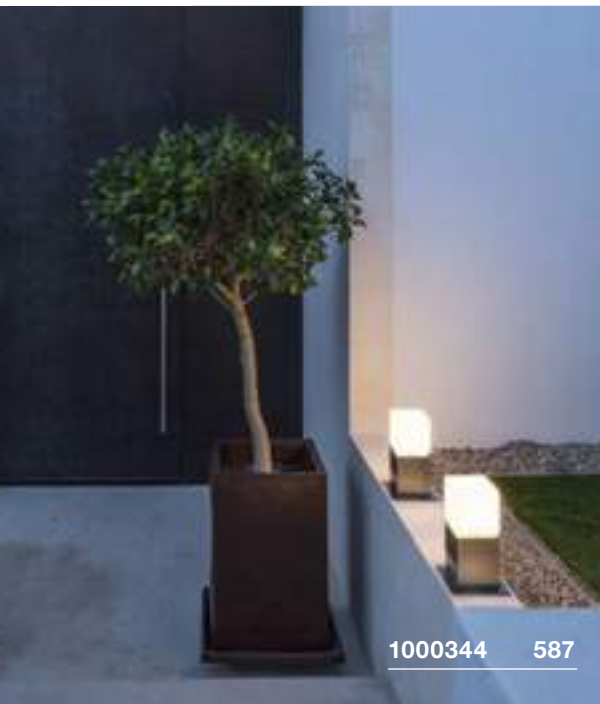

1000344 587



1000346 587



1000416 587

**SQUARE POLE 30/60/90**  
Pole, E27



SOCKET  
INSIDE



- Lights made from stainless steel 304
- Modern design for path lights
- Diffuse light distribution to illuminate your surroundings

**Product details**

220-240V ~50/60Hz  
Material: stainless steel 304



**Dimensional drawing**

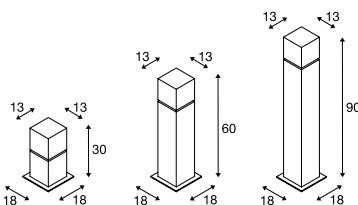

**Accessory recommendation**

- Connection box IP68, 3-pole  
Item No. 228730
- Concrete anchor  
Item No. 1000343
- Spike  
Item No. 231234

**Recommended lamp**

- LED E27 7W 280°  
2700K 790lm  
7kWh/1000h  
Item No. 1002124
- LED E27 9.1W 240°  
2700K 760lm  
10kWh/1000h  
Item No. 560402

**Lamp details**

max. 20W  
Diameter: 6 cm max. L: 15 cm max.

Variant	Item No.
E27   H: 30 cm   1.2 kg ■ stainless steel	1000344
E27   H: 60 cm   2.5 kg ■ stainless steel	1000345
E27   H: 90 cm   3.9 kg ■ stainless steel	1000346

**SQUARE POLE 30/60/90**  
Pole, PHASE



LED  
INSIDE



- Lights made from high-quality 316 stainless steel
- Modern design for path lights
- Diffuse light distribution to illuminate your surroundings

**Product details**

220-240V ~50/60Hz  
Total wattage: 12W  
Material: stainless steel 316  
Dimmable: C, L



**Dimensional drawing**

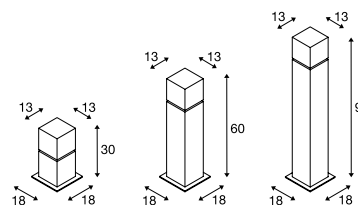

**Accessory recommendation**

- Connection box IP68, 3-pole  
Item No. 228730
- Concrete anchor  
Item No. 1000343
- Spike  
Item No. 231234

Variant	Item No.
760lm   3000K   CRI>80   H: 30 cm   2 kg ■ stainless steel	1000416
760lm   3000K   CRI>80   H: 60 cm   3.4 kg ■ stainless steel	1000417
760lm   3000K   CRI>80   H: 90 cm   4.7 kg ■ stainless steel	1000418

RUSTY® 40/70 Pole, E27

SOCKET INSIDE



- Rusted steel
- Every light is a unique one-off

Product details

230V -50Hz  
Material: FeCSi steel/polycarbonate (PC)

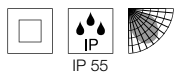

Dimensional drawing

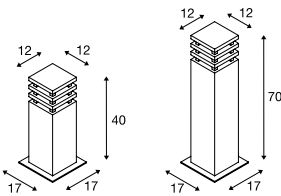

Accessory recommendation

- Connection box IP68, 3-pole  
Item No. 228730
- Spike  
Item No. 229422

Recommended lamp

LED E27 9W 240°  
3000K 810lm  
10kWh/1000h  
Item No. 1001031

LED E27 9W 240°  
4000K 850lm  
9kWh/1000h  
Item No. 1002827

Lamp details

max. 11W  
Diameter: 4.8 cm max. L: 13.9 cm max.

Variant	Item No.
E27   H: 40 cm   11 kg ■ rust	229420
E27   H: 70 cm   22 kg ■ rust	229421

RUSTY® 40/70 Pole

LED INSIDE



- Rusted steel
- Every light is a unique one-off
- High-voltage LED

Product details

220-240V ~50/60Hz  
Total wattage: 8.6W  
Material: FeCSi steel/polycarbonate (PC)

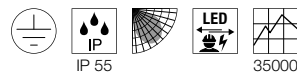

Dimensional drawing

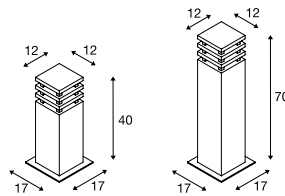

Tip

Open cable end

Accessory recommendation

- Connection box IP68, 3-pole  
Item No. 228730
- Spike  
Item No. 229422

Variant	Item No.
90lm   3000K   CRI>80   H: 40 cm   11 kg ■ rust	233427
90lm   3000K   CRI>80   H: 70 cm   22 kg ■ rust	233437



233427 588



231411 589



231410 589



231410 589

## ARROCK GRANITE 40/70

Pole, square, E27

SOCKET  
INSIDE



- Natural stone, granite, stainless steel
- Natural look with a glare-free lighting effect

### Product details

230V -50Hz  
Material: granite/stainless steel 304

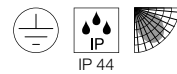

IP 44

### Dimensional drawing

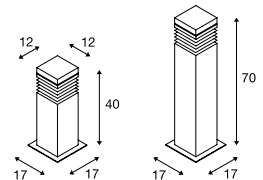

### Accessory recommendation

■ Connection box IP68, 3-pole  
Item No. 228730



■ Spike

Item No. 229422



### Recommended lamp

LED E27 9W 240°  
3000K 810lm  
10kWh/1000h  
Item No. 1001031



LED E27 9W 240°  
4000K 850lm  
9kWh/1000h  
Item No. 1002827



### Lamp details

max. 15W  
Diameter: 5.2 cm max. L: 11.5 cm max.

Variant	Item No.
E27   H: 40 cm   11 kg	
■ grey/chrome	231410
E27   H: 70 cm   22.5 kg	
■ grey/chrome	231411

**ARROCK ARC**  
Pole, QPAR51

SOCKET  
INSIDE

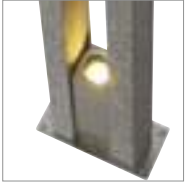

- Natural stone, granite, stainless steel
- Flat design with an unusual lighting effect

**Product details**

230V -50Hz  
Material: granite/stainless steel 304



**Dimensional drawing**

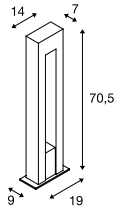

**Accessory recommendation**

■ Spike  
Item No. 231233



**Recommended lamp**

GU10 4W 36°  
2700K 300lm  
4kWh/1000h  
Item No. 1004972



LED GU10 5.5W 38°  
2700K 400lm  
6kWh/1000h  
Item No. 1001030



**Lamp details**

max. 35W QPAR51  
Diameter: 5 cm max. L: 7.6 cm max.

Variant	Item No.
GU10   QPAR51	
■ grey/chrome	231420



231420 590



231817 591



231455 591

**SLOTS 45**  
Pole

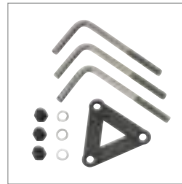

- Indirect light emission
- Unusual lighting effect to light the way safely

**Product details**

220-240V ~50/60Hz  
Total wattage: 6.3W  
Material: aluminium



**Dimensional drawing**

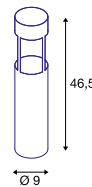

**Accessory recommendation**

- Connection box IP68, 3-pole  
Item No. 228730
- Screw set  
Item No. 228753



Variant	Item No.
200lm   3000K   CRI>80	
■ anthracite	231815
200lm   3000K   CRI>80	
■ rust	231817

**SLOTS 65**  
Pole



- Indirect light emission
- Unusual lighting effect to light the way safely

**Product details**

220-240V ~50/60Hz  
Total wattage: 6.3W  
Material: aluminium

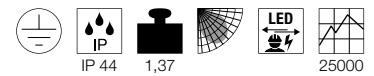

**Dimensional drawing**

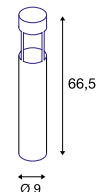

**Accessory recommendation**

- Connection box IP68, 3-pole  
Item No. 228730
- Screw set  
Item No. 228753



Variant	Item No.
200lm   3000K   CRI>80	
■ anthracite	231455
200lm   3000K   CRI>80	
■ rust	231457

**BOOKAT**  
Pole, PHASE



- High-voltage LED

**Product details**

230V -50Hz  
Total wattage: 13W  
Material: aluminium  
Dimmable: C, L

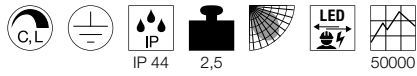

**Dimensional drawing**

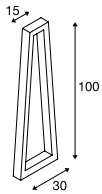

**Tip**

Open cable end

**Accessory recommendation**

■ Connection box IP68, 3-pole  
Item No. **228730**



Variant	Item No.
370lm   3000K   CRI>80 ■ anthracite	<b>231855</b>







RASCALI 45/65  
Pole



- Unusual design
- Asymmetrical light distribution for accentuated illumination of paths and areas

Product details

220-240V ~50Hz  
Total wattage: 8W  
Material: aluminium



IP 65

30000

IK02

Dimensional drawing

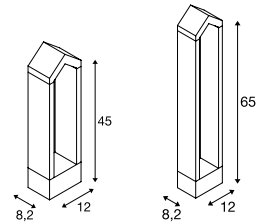

1000799 593

Variant	Item No.
360lm   3000K   CRI>80   H: 45 cm   2.25 kg ■ anthracite	1000799
360lm   3000K   CRI>80   H: 65 cm   2.8 kg ■ anthracite	1000801



1003535 595



1003536 595



1003537 595



L-LINE OUT 60  
FL, vertical



- The light colour can be selected during installation using a switch

Product details

220-240V ~50/60Hz | 500mA  
System output: 11.5W  
Material: aluminium/polycarbonate (PC)

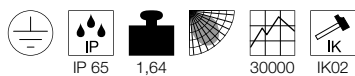

Dimensional drawing

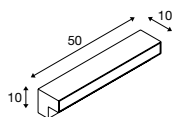

Accessory recommendation

■ Connection box IP68, 3-pole  
Item No. 228730



Variant	Item No.
780/800lm   3000/4000K   CRI>80 ■ matt anthracite	1003535

L-LINE OUT 30  
FL, vertical



- The light colour can be selected during installation using a switch

Product details

220-240V ~50/60Hz | 500mA  
System output: 11.5W  
Material: aluminium/polycarbonate (PC)



Dimensional drawing

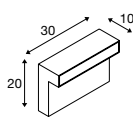

Accessory recommendation

■ Connection box IP68, 3-pole  
Item No. 228730



Variant	Item No.
800/810lm   3000/4000K   CRI>80 ■ matt anthracite	1003536

L-LINE OUT 50/80  
Pole, horizontal



- The light colour can be selected during installation using a switch

Product details

220-240V ~50/60Hz | 350mA  
Total wattage: 7W  
Material: aluminium/polycarbonate (PC)

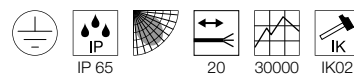

Dimensional drawing

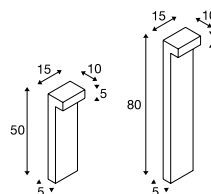

Accessory recommendation

■ Connection box IP68, 3-pole  
Item No. 228730



Variant	Item No.
490/530lm   3000/4000K   CRI>80 H: 50cm   1.95kg ■ matt anthracite	1003537
490/530lm   3000/4000K   CRI>80 H: 80cm   2.6kg ■ matt anthracite	1003538

H-POL 30/60  
Pole



- One-sided light emission

Product details

100-277V ~50/60Hz | 500mA  
Material: aluminium/plastic  
Installation dimensions:  
W: 11.8 cm L: 11.8 cm D: 10 cm



Dimensional drawing

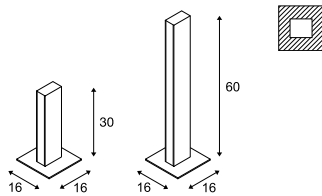

Tip

This product is intended for in-floor installation. A larger recessed fixing kit is available for optional installation in the ground. Installation dimensions of the optional recessed fixing kit: L: 14 cm W: 14 cm D: 16 cm.

Accessory recommendation

■ Recessed fixing kit  
Item No. **232195**

Variant	Item No.
350lm   3000K   CRI>80   9W   H: 36 cm   1.4 kg ■ anthracite	<b>232155</b>
700lm   3000K   CRI>80   18W   H: 66 cm   2.3 kg ■ anthracite	<b>232165</b>

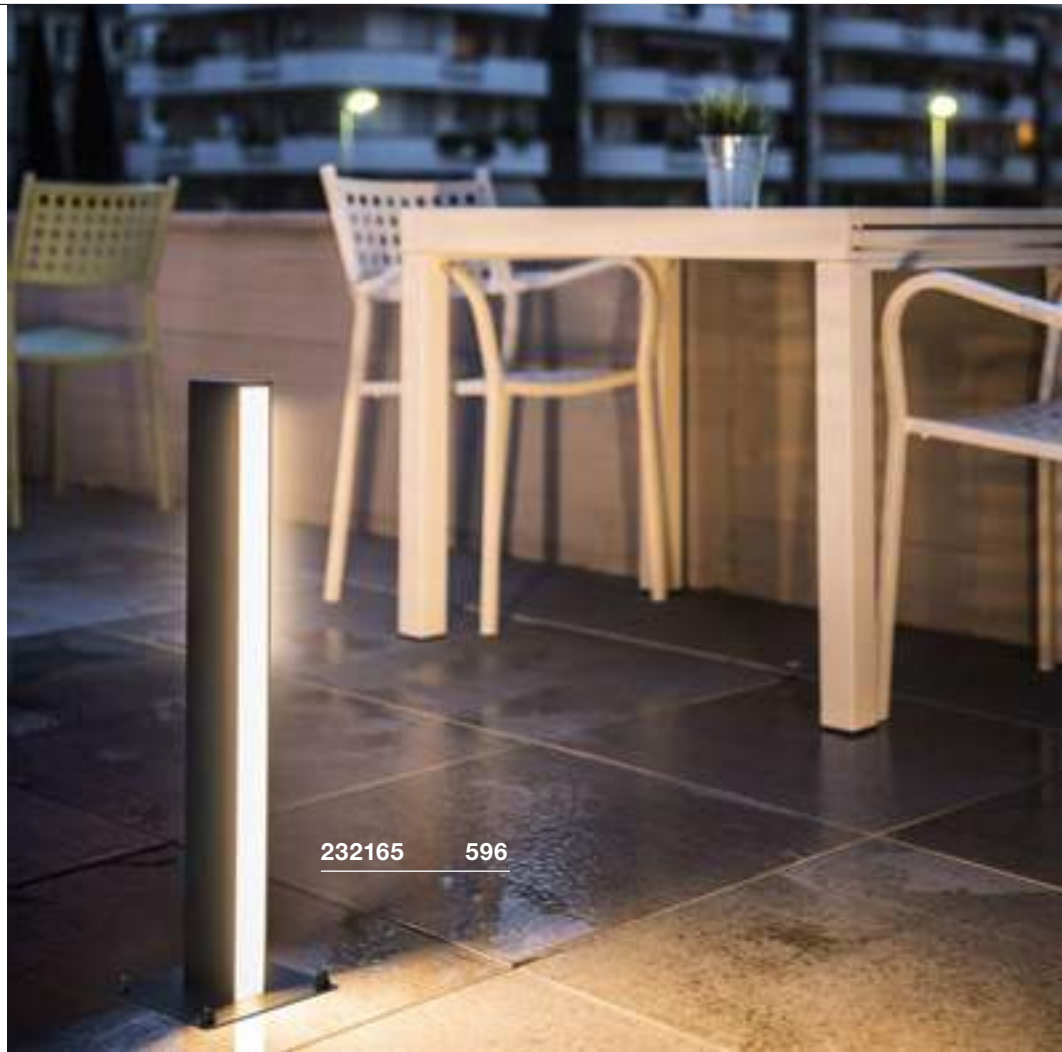

232165    596

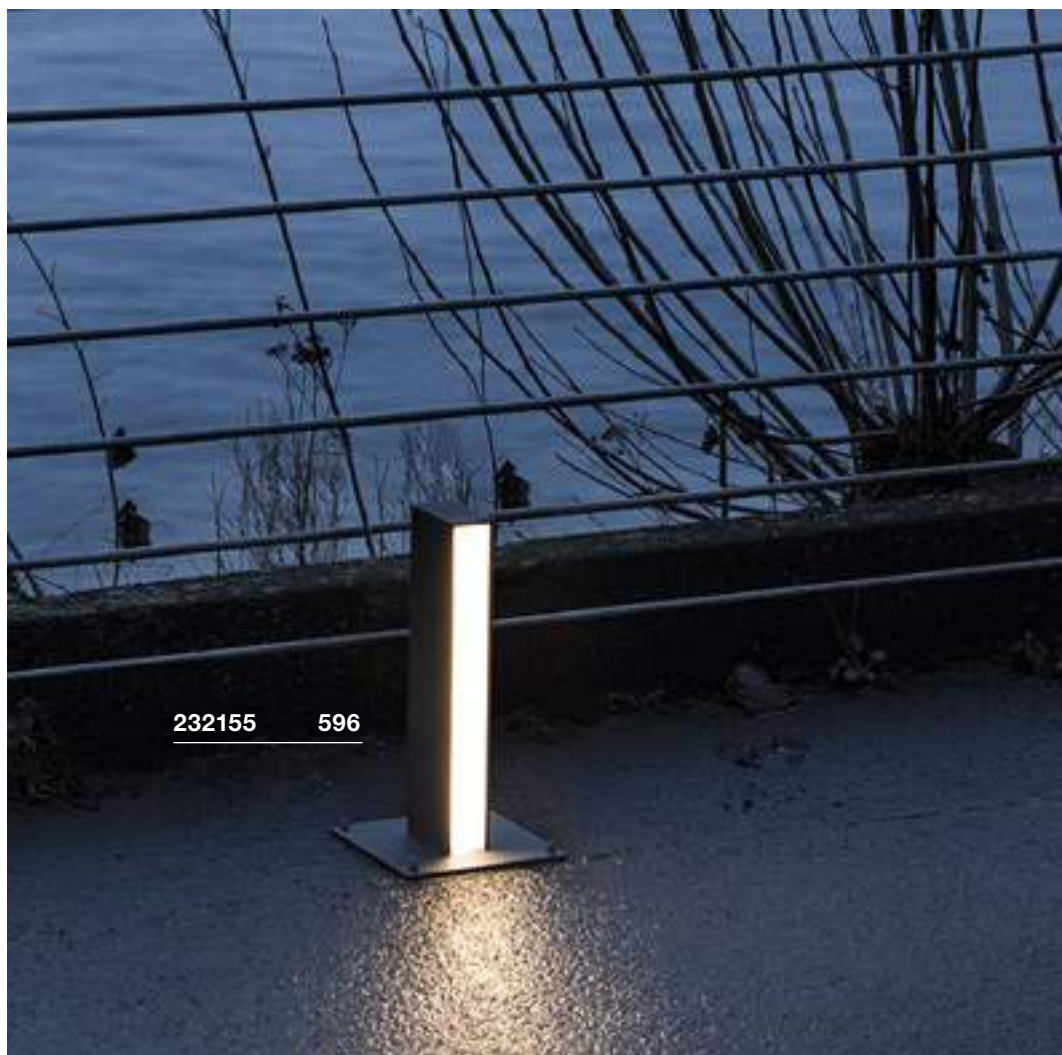

232155    596



232175 597

## H-POL TWIN 30/60 Pole



- Double-sided light emission

### Product details

220-240V ~50/60Hz | 1000mA  
Material: aluminium/plastic  
Installation dimensions:  
W: 11.8 cm L: 11.8 cm D: 10 cm



IP 55

30000

9/18

### Dimensional drawing

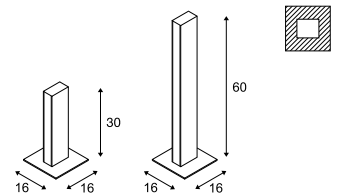

### Tip

This product is intended for in-floor installation. A larger recessed fixing kit is available for optional installation in the ground. Installation dimensions of the optional recessed fixing kit: L: 14 cm W: 14 cm D: 16 cm.

### Accessory recommendation

■ Recessed fixing kit  
Item No. 232195



Variant	Item No.
Direkt: 350lm   3000K   CRI>80 Indirekt: 350lm   3000K   CRI>80 18W   H: 36 cm   1.6 kg	232175
■ anthracite	
Direkt: 700lm   3000K   CRI>80 Indirekt: 700lm   3000K   CRI>80 35W   H: 66 cm   2.5 kg	232185
■ anthracite	

SLOTBOX 40/70  
Pole



Product details

200-240V ~50/60Hz | 700mA  
Total wattage: 8W  
Material: aluminium



Dimensional drawing

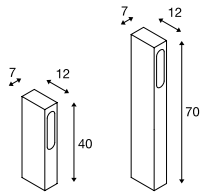

Tip

Open cable end

Accessory recommendation

■ Connection box IP68, 3-pole  
Item No. 228730



Variant	Item No.
160lm   3000K   CRI>80   H: 40 cm   1.45 kg ■ anthracite	232135
160lm   3000K   CRI>80   H: 70 cm   2.1 kg ■ anthracite	232145



232135 598



232145 598



1002958 599

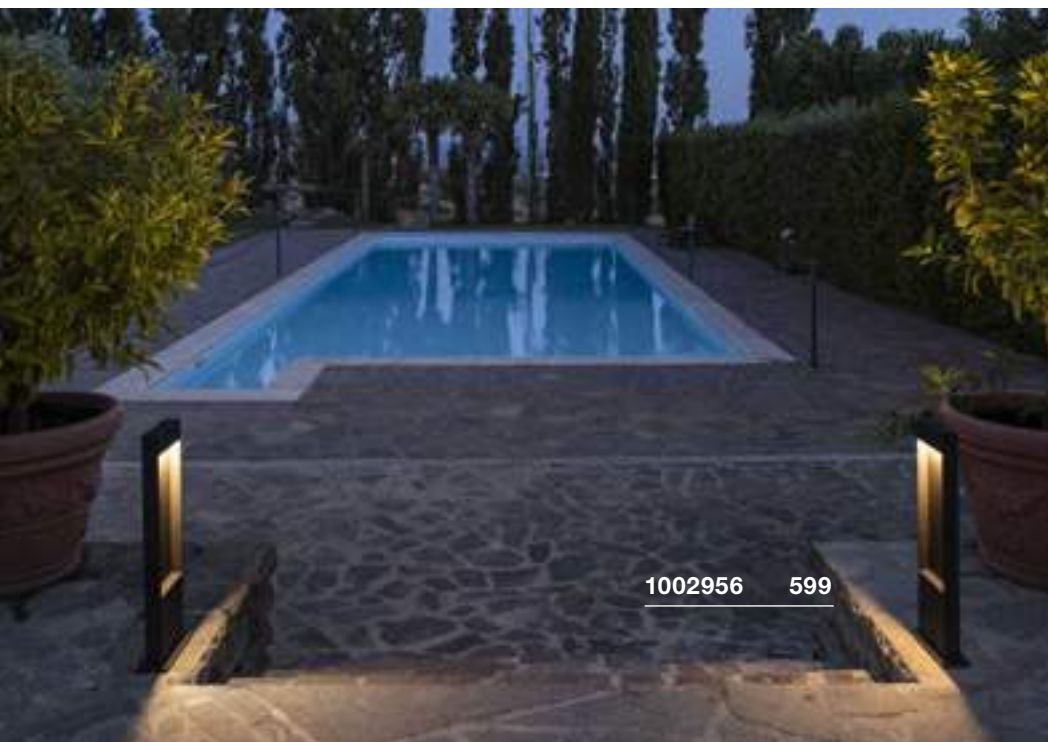

1002956 599

FLATT 65/100  
Pole



- The light colour can be selected during installation using a switch

Product details

100-240V ~50/60Hz | 350mA  
Total wattage: 9.7W  
Material: aluminium/aluminium



Dimensional drawing

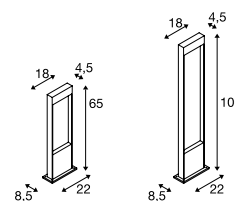

Variant	Item No.
400lm   3000/4000K   CRI80   H: 65 cm   3.2 kg ■ anthracite/anthracite	<b>1002956</b>
400lm   3000/4000K   CRI80   H: 65 cm   3.2 kg ■ anthracite/brown	<b>1002957</b>
400lm   3000/4000K   CRI80   H: 100 cm   4.47 kg ■ anthracite/anthracite	<b>1002958</b>
400lm   3000/4000K   CRI80   H: 100 cm   4.47 kg ■ anthracite/brown	<b>1002959</b>

**ARROCK STONE 50/75**  
Pole



- Basalt/stainless steel
- Unusual lighting effect

**Product details**

100-240V ~50/60Hz | 700mA  
System output: 9W  
Material: basalt/stainless steel 304

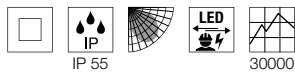

**Dimensional drawing**

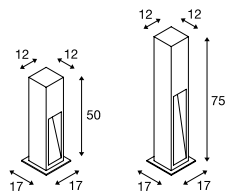

**Accessory recommendation**

■ Spike  
Item No. **231235**



**ARROCK SLOT**  
Pole, QPAR51



- Natural stone, granite, stainless steel
- Unusual lighting effect, natural look

**Product details**

230V -50Hz  
Material: granite/stainless steel 304

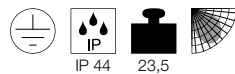

**Dimensional drawing**

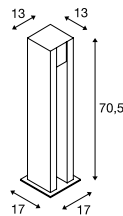

**Tip**

Open cable end

**Accessory recommendation**

■ Spike  
Item No. **231235**  
■ Connection box IP68, 3-pole  
Item No. **228730**



**Recommended lamp**

LED GU10 4W 36°  
3000K 300lm  
4kWh/1000h  
Item No. **1004973**



LED GU10 4W 36°  
4000K 300lm  
4kWh/1000h  
Item No. **1004974**



**Lamp details**

max. 4W LED GU10 51mm

Variant	Item No.
330lm   3000K   CRI>80   H: 50 cm   15.5 kg ■ grey	<b>231370</b>
330lm   3000K   CRI>80   H: 75 cm   22.2 kg ■ grey	<b>231371</b>

Variant	Item No.
GU10   LED GU10 51mm ■ grey/chrome	<b>231440</b>

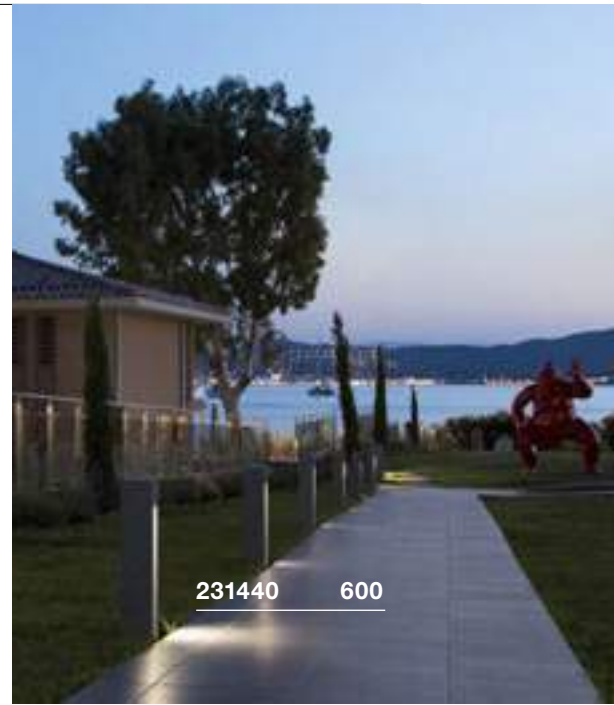

**231440 600**



**231440 600**



**231371 600**





229411 601



229410 601



233447 601

RUSTY® SLOT 50/80 Pole, E27

SOCKET INSIDE



- Rusted steel
- Every light is a unique one-off
- Unusual lighting effect

Product details

230V -50Hz  
Material: FeCSi steel/polycarbonate (PC)

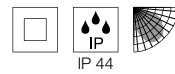

Dimensional drawing

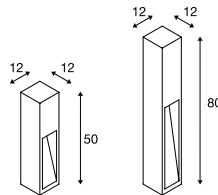

Accessory recommendation

■ Connection box IP68, 3-pole

Item No. 228730

■ Spike

Item No. 231230

Recommended lamp

LED E27 9W 240°  
3000K 810lm  
10kWh/1000h  
Item No. 1001031

LED E27 9W 240°  
4000K 850lm  
9kWh/1000h  
Item No. 1002827

Lamp details

max. 11W  
Diameter: 4.8 cm max. L: 13.9 cm max.

Variant	Item No.
E27   H: 50 cm   12.5 kg ■ rust	229410
E27   H: 80 cm   18.5 kg ■ rust	229411

RUSTY® SLOT 50/80 Pole

LED INSIDE



- Rusted steel
- Every light is a unique one-off
- Unusual lighting effect

Product details

220-240V ~50/60Hz  
Total wattage: 8.6W  
Material: FeCSi steel/polycarbonate (PC)

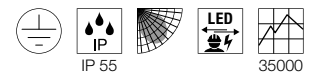

Dimensional drawing

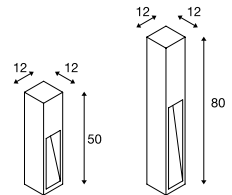

Tip

Open cable end

Accessory recommendation

■ Connection box IP68, 3-pole

Item No. 228730

■ Spike

Item No. 231230

Variant	Item No.
30lm   3000K   CRI>80   H: 50 cm   12.5 kg ■ rust	233447
30lm   3000K   CRI>80   H: 80 cm   18.5 kg ■ rust	233457

**BENDO 80/220**  
Pole, PHASE



reddot award 2018  
winner

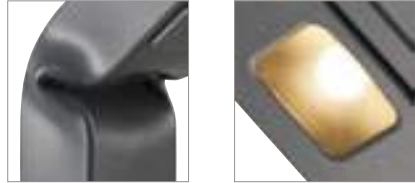

- High-voltage LED
- Exclusive design for an unusual outdoor area

**Product details**

220-240V ~50/60Hz  
Material: aluminium/glass  
Dimmable: C, L

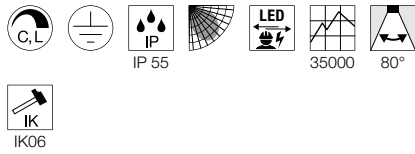

**Dimensional drawing**

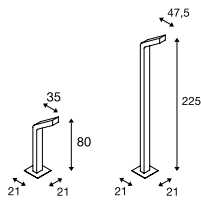

**Accessory recommendation**

- Concrete anchor  
Item No. **231849**
- Connection box IP68, 3-pole  
Item No. **228730**
- T-connector box  
Item No. **228726**

Variant	Item No.
700lm   3000K   CRI>80   H: 80 cm   11W   2.7 kg ■ anthracite	<b>231835</b>
1800lm   3000K   CRI>80   H: 225 cm   31W   7.3 kg ■ anthracite	<b>231845</b>



reddot award 2018  
winner



231835 602

**DESIGNED BY**  
Carsten Witsch





230090 603



230090 603



1001824 603

### RUSTY® PATHLIGHT Pole, TCR-TSE

SOCKET INSIDE



- Rusted steel
- Every light is a unique one-off
- Linear, natural look

#### Product details

230V ~50Hz  
Material: FeCSi steel/polycarbonate (PC)

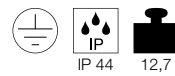

#### Dimensional drawing

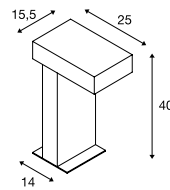

#### Accessory recommendation

- Connection box IP68, 3-pole  
Item No. 228730
- Spike  
Item No. 229422

#### Recommended lamp

LED GX53 3W 120°  
3000K 250lm  
3kWh/1000h  
Item No. 551372

#### Lamp details

max. 9W TCR-TSE  
Diameter: 7.5 cm max. L: 2.7 cm max.

Variant	Item No.
GX53   TCR-TSE	
■ rust	230090

### RUSTY® PATHLIGHT 40/70 Pole

LED INSIDE



- Rusted steel
- Every light is a unique one-off

#### Product details

220-240V ~50/60Hz  
Total wattage: 8.9W  
Material: FeCSi steel/polycarbonate (PC)

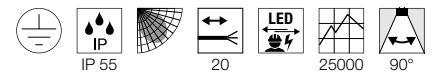

#### Dimensional drawing

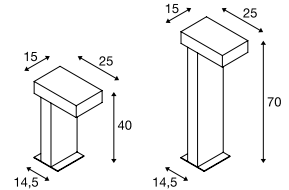

#### Tip

Open cable end

#### Accessory recommendation

- Connection box IP68, 3-pole  
Item No. 228730
- Spike  
Item No. 229422

Variant	Item No.
400lm   3000K   CRI>80   H: 40 cm   12.5 kg	
■ rust	1001823
400lm   3000K   CRI>80   H: 70 cm   18.9 kg	
■ rust	1001824

**ABRIDOR 60/100**  
Pole

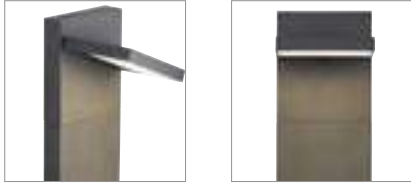

- The light colour can be selected during installation using a switch
- Pivoting light head

**Product details**

100-277V ~50/60Hz | 300mA  
Total wattage: 14W  
Material: aluminium

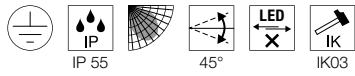

**Dimensional drawing**

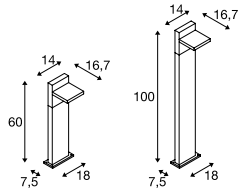

**Tip**

Open cable end

**Accessory recommendation**

■ Connection box IP68, 3-pole  
**Item No. 228730**



Variant	Item No.
750lm   3000/4000K   CRI80   H: 60 cm   2.3 kg ■ matt anthracite	<b>1002991</b>
750lm   3000/4000K   CRI80   H: 100 cm   3.4 kg ■ matt anthracite	<b>1002992</b>



1002992 604

231355 667



231305 605



232294 605

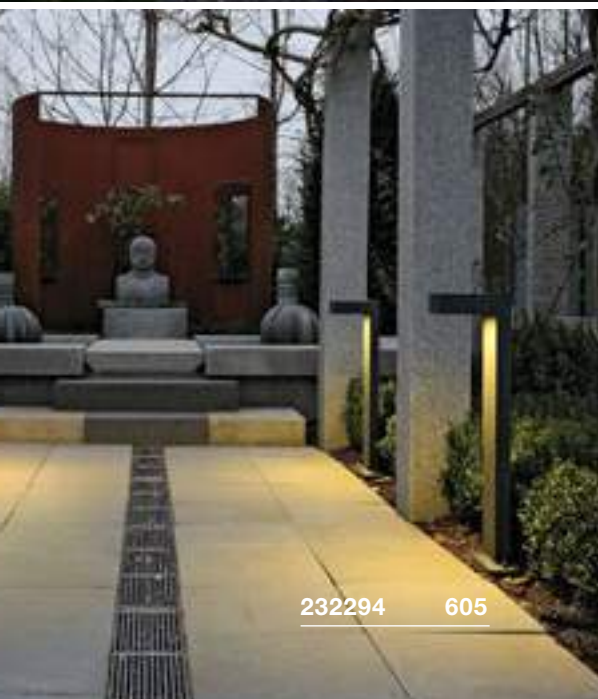

232294 605

**IPERI 50**  
Pole



**QUADRASYL 75**  
Pole, TCR-TSE



SOCKET  
INSIDE



- Pth lights for driveways and gardens

**Product details**

230V -50Hz  
Total wattage: 5W  
Material: aluminium/plastic

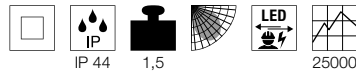

**Product details**

220-240V ~50/60Hz  
Material: aluminium

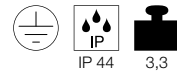

**Dimensional drawing**

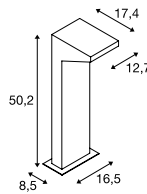

**Dimensional drawing**

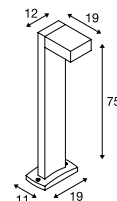

**Accessory recommendation**

■ Spike  
Item No. 231231



**Accessory recommendation**

■ T-connector box  
Item No. 228726



**Recommended lamp**

GX53 3W 120°  
3000K 250lm  
3kWh/1000h  
Item No. 551372



**Lamp details**

max. 11W TCR-TSE  
Diameter: 7.5 cm max. L: 2.7 cm max.

Variant	Item No.
320lm   4000K   CRI>70 ■ anthracite	231305

Variant	Item No.
GX53   TCR-TSE ■ grey	232294
GX53   TCR-TSE ■ anthracite	232295

**TRAPECCO**  
Pole



**Product details**

230V -50Hz  
Total wattage: 10W  
Material: aluminium



**Dimensional drawing**

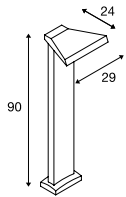

**Tip**

Open cable end

**Accessory recommendation**

■ Connection box IP68, 3-pole  
Item No. **228730**



Variant	Item No.
850lm   3000K   CRI>80 ■ anthracite	231765 ▼

**MALU**  
Pole



reddot award 2019  
winner

**Product details**

220-240V ~50/60Hz  
Total wattage: 9.2W  
Material: aluminium/glass

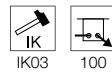

**Dimensional drawing**

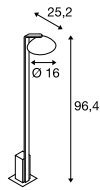

**Tip**

Integrated connection box

Variant	Item No.
360lm   3000K   CRI>80 ■ anthracite	1002158

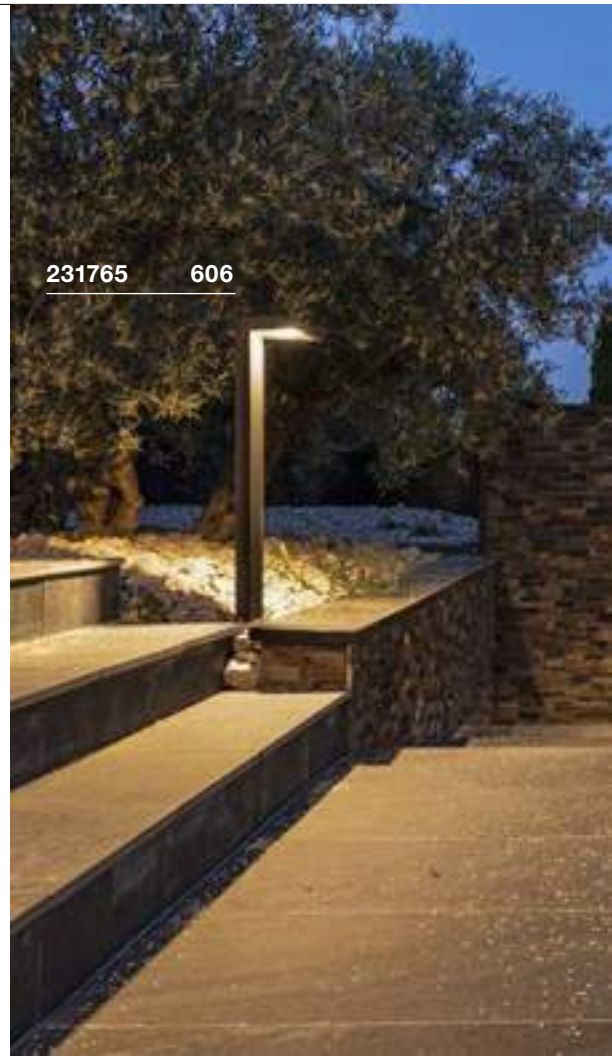

231765 606

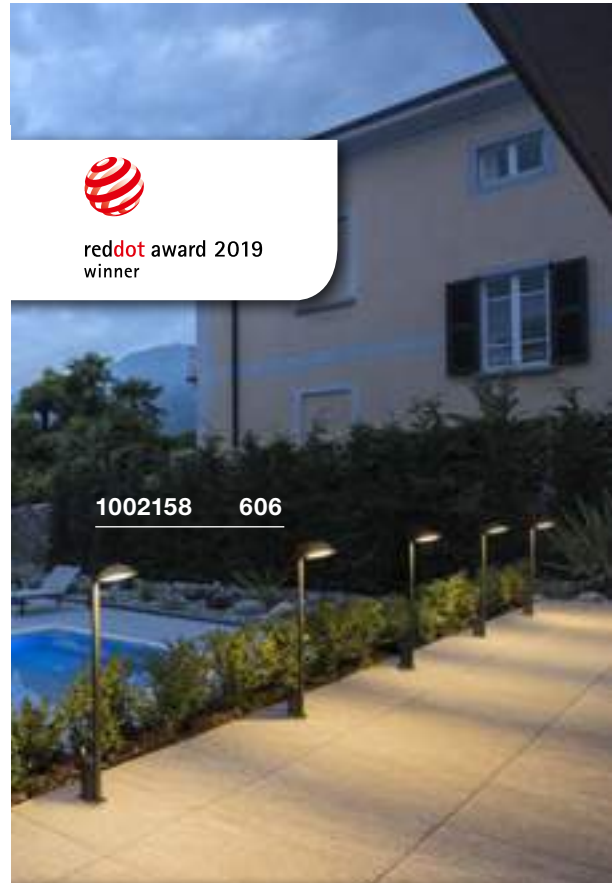

reddot award 2019  
winner

1002158 606

**DESIGNED BY**  
Philippe Stephant

*Philippe Stephant*



228545 607



1002907 607

**ENOLA C**  
Pole



**ESKINA 30/80**  
Pole, PHASE



- The light colour can be selected during installation using a switch

**Product details**

100-240V ~50/60Hz | 500mA  
Total wattage: 12W  
Material: aluminium/glass

**Product details**

220-240V ~50/60Hz | 350mA  
Total wattage: 14.5W  
Material: aluminium  
Dimmable: C

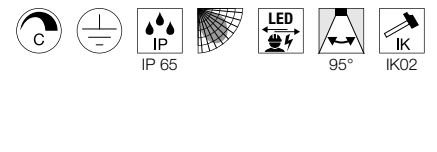
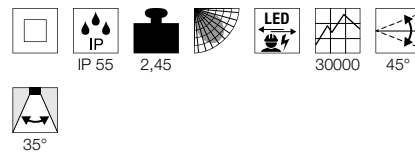

**Dimensional drawing**

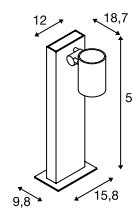

**Tip**

Open cable end

**Dimensional drawing**

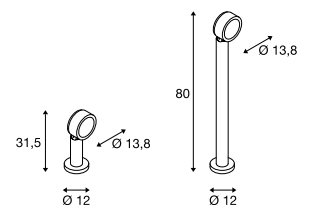

**Tip**

1002906 – Safety plug  
1002907 – Open cable end

**Accessory recommendation**

■ Connection box IP68, 3-pole  
Item No. 228730



**Accessory recommendation**

■ Spike  
Item No. 230060



Variant	Item No.
800lm   3000K   CRI>80 ■ anthracite	228545

Variant	Item No.
1000lm   3000/4000K   CRI>80 H: 31.5 cm   1.3 kg ■ matt anthracite	1002906
1000lm   3000/4000K   CRI>80 H: 80 cm   1.89 kg ■ matt anthracite	1002907

**THEO BRACKET 50/70**  
Pole



**NEW**

**SOCKET INSIDE**



**THEO PATHLIGHT**  
Pole, single



**SOCKET INSIDE**



**THEO PATHLIGHT**  
Pole, double



**SOCKET INSIDE**



**Product details**

220-240V ~50/60Hz  
Material: aluminium/glass

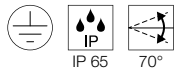

**Dimensional drawing**

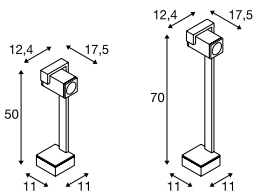

**Product details**

200-240V ~50/60Hz  
Material: aluminium

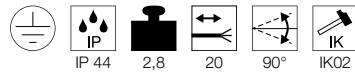

**Dimensional drawing**

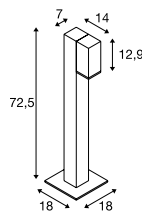

**Tip**

Open cable end

**Product details**

200-240V ~50/60Hz  
Material: aluminium



**Dimensional drawing**

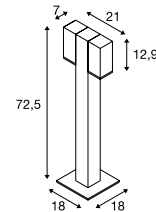

**Tip**

Open cable end

**Recommended lamp**

LED GU10 4W 36°  
2700K 300lm  
4kWh/1000h  
**Item No. 1004972**

LED GU10 5.5W 38°  
2700K 400lm  
6kWh/1000h  
**Item No. 1001030**



**Recommended lamp**

GU10 4W 36°  
2700K 300lm  
4kWh/1000h  
**Item No. 1004972**

LED GU10 3.7W 36°  
2700K 260lm  
4kWh/1000h  
**Item No. 560122**



**Recommended lamp**

GU10 4W 36°  
2700K 300lm  
4kWh/1000h  
**Item No. 1004972**

LED GU10 6W 36°  
3000K 460lm  
6kWh/1000h  
**Item No. 1005080**



**Lamp details**

max. 7W LED GU10 51mm  
Diameter: 5.1cm max. L: 5.7cm max.

Variant	Item No.
GU10   H:50cm   1.5kg ■ matt anthracite	<b>1004654</b>
GU10   H:70cm   1.7kg ■ matt anthracite	<b>1004655</b>

**Lamp details**

max. 7W

Variant	Item No.
GU10 ■ matt anthracite	<b>1002870</b>

**Lamp details**

2x max. 7W

Variant	Item No.
GU10 ■ matt anthracite	<b>1002871</b>



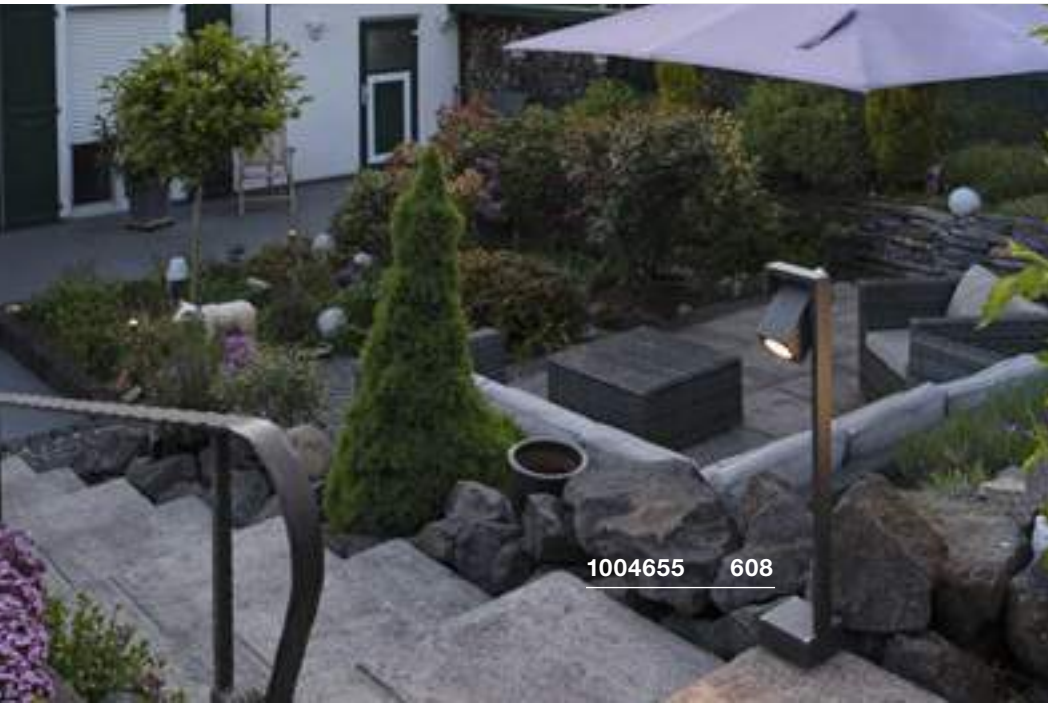

1004655 608



1002871 608



1003001 609

QUAD POLE



- Pivoting light head

Product details

100-277V ~50/60Hz | 500mA  
 Total wattage: 18W  
 Material: aluminium/glass

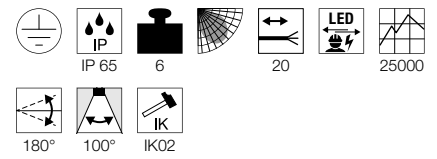

Dimensional drawing

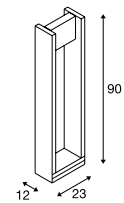

Tip

Open cable end

Accessory recommendation

■ Connection box IP68, 3-pole  
 Item No. 228730



Variant	Item No.
1550lm   3000K   CRI>80 ■ matt anthracite	1003001

**HELIA**  
Pole, single, PHASE



- High-voltage LED

**Product details**

220-240V ~50/60Hz  
Total wattage: 8W  
Material: aluminium/glass  
Dimmable: C, L

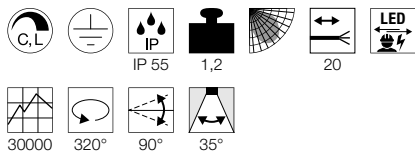

**Dimensional drawing**

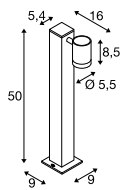

**Tip**

Open cable end

**Accessory recommendation**

- Spike  
Item No. 1000736
- Connection box IP68, 3-pole  
Item No. 228730

Variant	Item No.
450lm   3000K   CRI>80 ■ anthracite	1002198

**HELIA SENSOR**  
Single



- Integrated infrared sensor
- High-voltage LED

**Product details**

220-240V ~50/60Hz  
Total wattage: 8W  
Material: aluminium

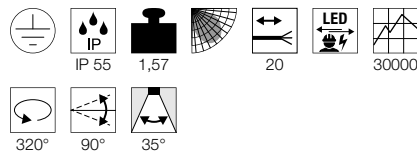

**Dimensional drawing**

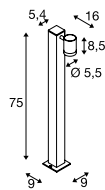

**Tip**

Open cable end

**Accessory recommendation**

- Spike  
Item No. 1000736
- Connection box IP68, 3-pole  
Item No. 228730

Variant	Item No.
450lm   3000K   CRI>80 ■ anthracite	1002199



1002199 610

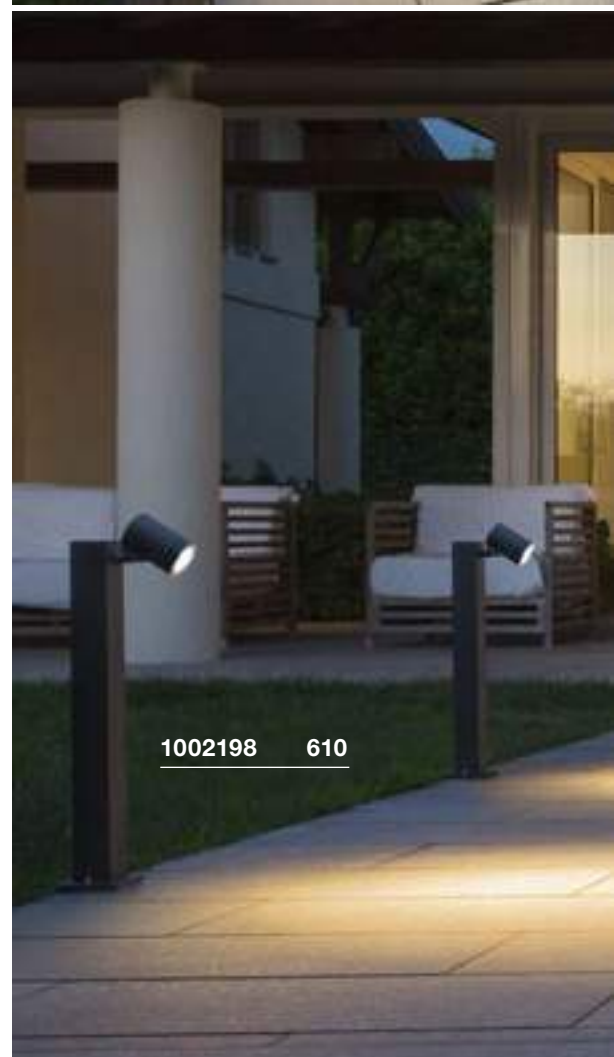

1002198 610



1002200 581

HELIA  
Pole, double, PHASE

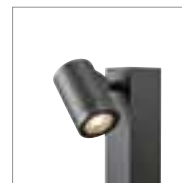

- High-voltage LED

Product details

220-240V ~50/60Hz  
Total wattage: 16W  
Material: aluminium/glass  
Dimmable: C, L

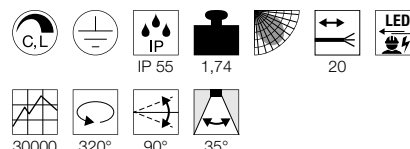

Dimensional drawing

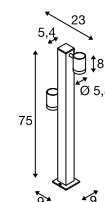

Tip

Open cable end

Accessory recommendation

- Spike  
Item No. 1000736
- Connection box IP68, 3-pole  
Item No. 228730



Variant	Item No.
900lm   3000K   CRI>80 ■ anthracite	1002200

SITRA 360  
Pole, TCR-TSE



SOCKET  
INSIDE



231505 612

Product details

230V -50Hz  
Material: aluminium/glass



Dimensional drawing

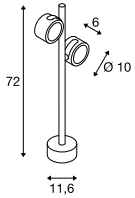

Accessory recommendation

■ Spike  
Item No. 230060



Recommended lamp

GX53 3W 120°  
3000K 250lm  
3kWh/1000h  
Item No. 551372



LED GX53 8.2W 120°  
4000K 620lm  
9kWh/1000h  
Item No. 550074



Lamp details

2x max. 9W TCR-TSE  
Diameter: 7.5 cm max. L: 3.5 cm max.

Variant	Item No.
GX53   TCR-TSE	
■ anthracite	231505



233285 613



**MYRA SPOT**  
Double, GU10



SOCKET  
INSIDE



- Extendable
- Unusual design to light the way safely

**Product details**

220-240V ~50/60Hz  
Material: aluminium



**Dimensional drawing**

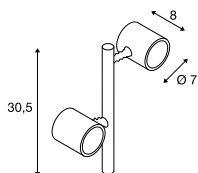

**Tip**

The height of the light can be increased by a maximum of 2 extension rods. Open cable end

**Accessory recommendation**

- Screw set  
Item No. 228752
- Concrete anchor  
Item No. 228712
- Extension rod 30cm  
Item No. 233164
- Pedestal  
Item No. 233144
- Extension rod 30cm  
Item No. 233165
- Pedestal  
Item No. 233145

**Recommended lamp**

LED GU10 4W 36°  
3000K 300lm  
4kWh/1000h  
Item No. 1004973

**Lamp details**

2x max. 4.5W LED GU10 51mm  
Diameter: 5cm max. L: 5.7cm max.

Variant	Item No.
GU10   LED GU10 51mm	
■ grey	233184
GU10   LED GU10 51mm	
■ anthracite	233185

**HELIA**  
Pole, single, PHASE



LED  
INSIDE



- High-voltage LED

**Product details**

220-240V ~50/60Hz  
Total wattage: 8W  
Material: aluminium  
Dimmable: C, L

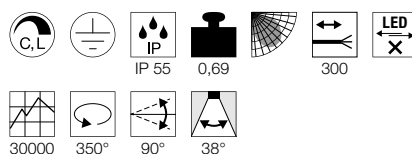

**Dimensional drawing**

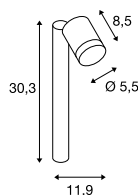

**Tip**

The height of the light can be increased by a maximum of 2 extension rods. Open cable end

**Accessory recommendation**

- Extension rod 30cm  
Item No. 233165
- Pedestal  
Item No. 233145
- Screw set  
Item No. 228752
- Concrete anchor  
Item No. 228712

Variant	Item No.
450lm   3000K   CRI>80	
■ anthracite	233275

**HELIA**  
Pole, double, PHASE



LED  
INSIDE



- High-voltage LED

**Product details**

220-240V ~50/60Hz  
Total wattage: 16W  
Material: aluminium  
Dimmable: C, L

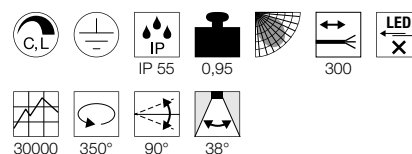

**Dimensional drawing**

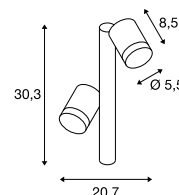

**Tip**

The height of the light can be increased by a maximum of 2 extension rods. Open cable end

**Accessory recommendation**

- Extension rod 30cm  
Item No. 233165
- Pedestal  
Item No. 233145
- Screw set  
Item No. 228752
- Concrete anchor  
Item No. 228712

Variant	Item No.
900lm   3000K   CRI>80	
■ anthracite	233285

# THE SUN'S COMING UP.

FLOODLIGHTS CREATE  
DYNAMIC LIGHT EMPHASIS.

---

Do you want effective outdoor lighting?  
If so, discover the wide range of floodlights which make individual  
lighting possible. On buildings, squares, pavements and in gardens.





1004757 619

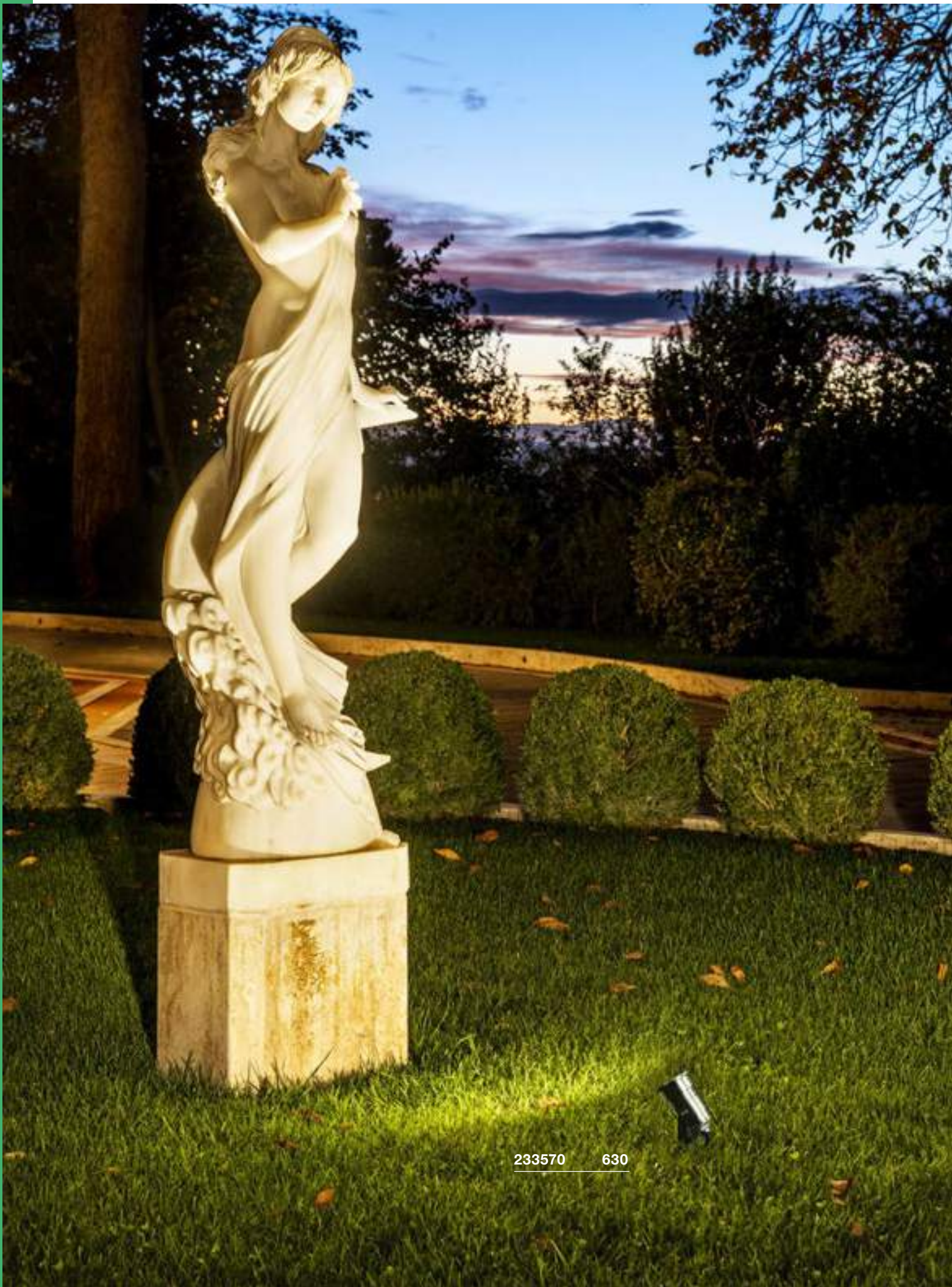

233570 630





1000735 + 1000736 631

## SPOTLIGHT

 618	 618	<b>NEW</b>  619	 620	<b>NEW</b>  620	 621	 622	 622
 623	 623	 625	 625	 627	 629	 629	 629
 630	 630	 631	 631	 633	 633	 633	 634
 635	 636	<b>NEW</b>  637					



Other luminaires and variants can be found online at [www.slv.com](http://www.slv.com)  
You can find manufacturer's details for our recommended lamps in the chapter 'Lightbulbs', from page 844

**NAUTILUS 10**  
SP, round, QPAR51



SOCKET  
INSIDE



**BIG NAUTILUS**  
SP, round, QPAR51



SOCKET  
INSIDE



**Product details**

230V -50Hz  
Material: aluminium



**Product details**

230V -50Hz  
Material: aluminium

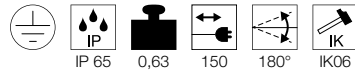

**Dimensional drawing**

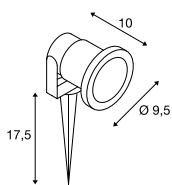

**Tip**

IP safety plug  
Earthspike included

**Recommended lamp**

LED GU10 5.5W 38°  
2700K 400lm  
6kWh/1000h  
Item No. 1001030



LED GU10 4W 36°  
2700K 300lm  
4kWh/1000h  
Item No. 1004972



**Lamp details**

max. 35W QPAR51  
L: 5.7 cm max.

Variant	Item No.
GU10   QPAR51	
■ grey	227418

**Dimensional drawing**

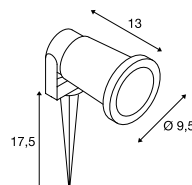

**Tip**

IP safety plug  
Earthspike included

**Recommended lamp**

LED GU10 5.5W 38°  
2700K 400lm  
6kWh/1000h  
Item No. 1001030



LED GU10 4W 36°  
3000K 300lm  
4kWh/1000h  
Item No. 1004973



**Lamp details**

max. 11W QPAR51  
Diameter: 5 cm max. L: 8.3 cm max.

Variant	Item No.
GU10   LED GU10 51mm	
■ black	227410
GU10   LED GU10 51mm	
■ brown	1001964
GU10   LED GU10 51mm	
■ green	1001965

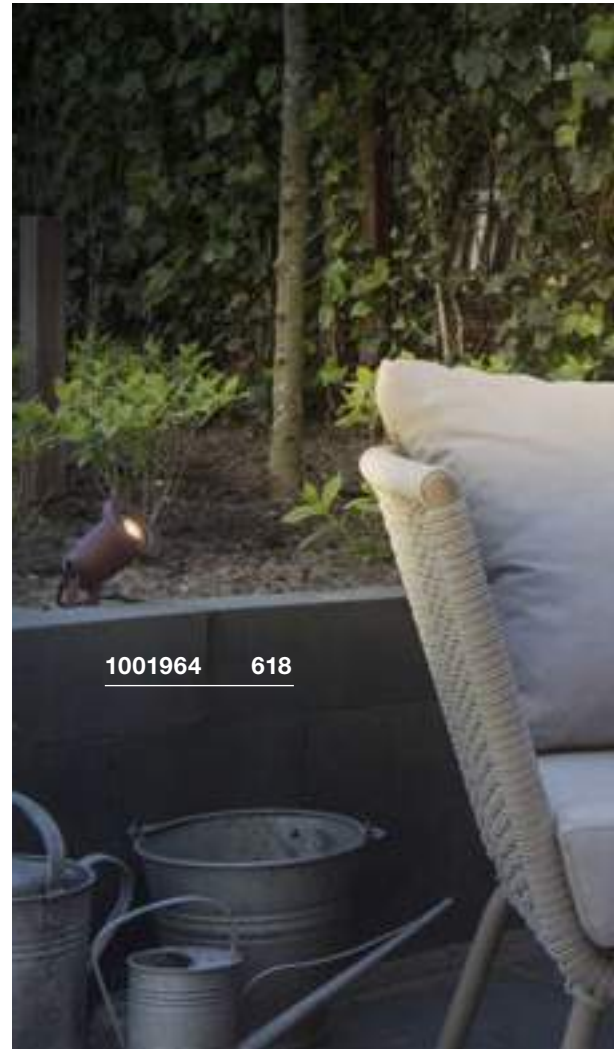



1004757 619

**SAMRINA**  
SP, single, GU10**NEW****SOCKET**  
**INSIDE**

- Contains recycled material

**Product details**220-240V ~50/60Hz  
Material: plastic/glass

IP 65

0,45

150

280°

IK04

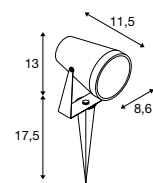
**Dimensional drawing****Tip**IP safety plug  
Earthspike included**Recommended lamp**LED GU10 4W 36°  
2700K 300lm  
4kWh/1000h  
**Item No. 1004972**LED GU10 4W 36°  
3000K 300lm  
4kWh/1000h  
**Item No. 1004973**

Variant	Item No.
GU10 ■ matt black	1004757

**NAUTILUS 10**  
SP, round, QPAR51



SOCKET  
INSIDE



• Stainless steel 316

**Product details**

230V -50Hz  
Material: stainless steel 316



**Dimensional drawing**

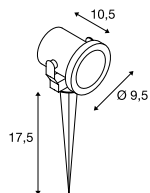

**Tip**

IP safety plug  
Earthsipike included

**Recommended lamp**

LED GU10 3.7W 36°  
2700K 260lm  
4kWh/1000h  
Item No. 560122



LED GU10 4W 36°  
3000K 300lm  
4kWh/1000h  
Item No. 1004973



**Lamp details**

max. 25W QPAR51  
Diameter: 5cm max. L: 5.7cm max.

Variant	Item No.
GU10   QPAR51 ■ stainless steel	229740

**THEO BRACKET**  
SP



NEW

SOCKET  
INSIDE



**Product details**

220-240V ~50/60Hz  
Material: aluminium/glass



**Dimensional drawing**

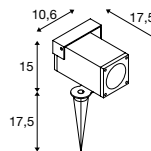

**Tip**

IP safety plug  
Earthsipike included

**Recommended lamp**

LED GU10 4W 36°  
2700K 300lm  
4kWh/1000h  
Item No. 1004972



LED GU10 4W 36°  
4000K 300lm  
4kWh/1000h  
Item No. 1004974



**Lamp details**

max. 7W LED GU10 51mm  
Diameter: 5.1cm max. L: 5.7cm max.

Variant	Item No.
GU10   LED GU10 51mm ■ anthracite	1004652





231035 621



1004652 620

NAUTILUS 10  
SP, square



- Perfectly for targeted accentuation of objects and areas

Product details

100-240V ~50/60Hz | 700mA  
Total wattage: 8.5W  
Material: aluminium/glass

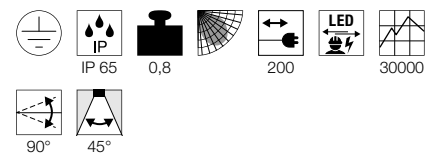

Dimensional drawing

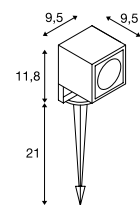

Tip

IP safety plug  
Earthspike included

Variant	Item No.
620lm   3000K   CRI>80 ■ anthracite	231035
620lm   3000K   CRI>80 ■ brown	1001937
620lm   3000K   CRI>80 ■ green	1001938

LED SPIKE  
SP



- Perfectly for targeted accentuation of objects and areas

Product details

100-240V ~50/60Hz | 240mA  
Total wattage: 6W  
Material: aluminium/glass

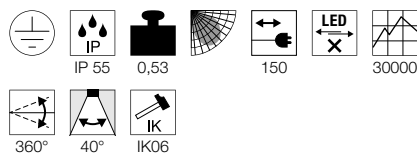

Dimensional drawing

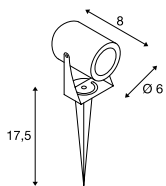

Tip

IP safety plug  
Earthspike included

SYNA  
SP

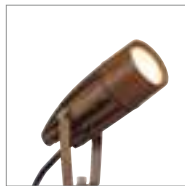

- High-voltage LED

Product details

220-240V ~50/60Hz  
Total wattage: 8.6W  
Material: aluminium/glass

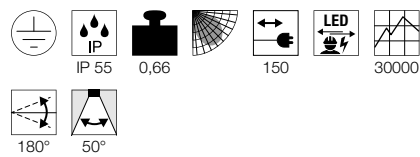

Dimensional drawing

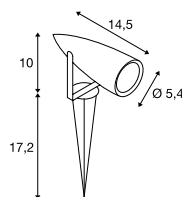

Tip

IP safety plug  
Earthspike included



1002201 622



227507 622

Variant	Item No.
400lm   3000K   CRI>80 ■ anthracite	1002201
400lm   3000K   CRI>80 ■ brown	1002203
400lm   3000K   CRI>80 ■ green	1002202

Variant	Item No.
470lm   3000K   CRI>80 ■ grey	227504
470lm   3000K   CRI>80 ■ anthracite	227505
470lm   3000K   CRI>80 ■ brown	227507
470lm   3000K   CRI>80 ■ green	227508



231535 623



231535 623

SITRA 360 SPIKE  
SP, single, TCR-TSE



SOCKET  
INSIDE



Product details

230V -50Hz  
Material: aluminium/glass



Dimensional drawing

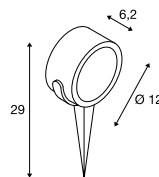

Tip

IP safety plug  
Earthspike included

Recommended lamp

LED GX53 3W 120°  
3000K 250lm  
3kWh/1000h  
Item No. 551372



LED GX53 8.2W 120°  
4000K 620lm  
9kWh/1000h  
Item No. 550074



Lamp details

max. 9W TCR-TSE  
Diameter: 7.5 cm max. L: 3.5 cm max.

Variant	Item No.
GX53   TCR-TSE ■ anthracite	231525

SITRA 360 SPIKE  
SP, double, TCR-TSE



SOCKET  
INSIDE



Product details

230V -50Hz  
Material: aluminium/glass

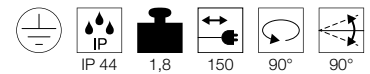

Dimensional drawing

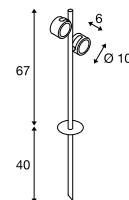

Tip

IP safety plug  
Earthspike included

Recommended lamp

LED GX53 3W 120°  
3000K 250lm  
3kWh/1000h  
Item No. 551372



LED GX53 8.2W 120°  
4000K 620lm  
9kWh/1000h  
Item No. 550074



Lamp details

2x max. 9W TCR-TSE  
Diameter: 7.5 cm max. L: 3.5 cm max.

Variant	Item No.
GX53   TCR-TSE ■ anthracite	231535



231682 625





CV SPOT  
SP, short

SOCKET  
INSIDE



- Stainless steel 304

Product details

230V -50Hz  
Material: stainless steel 304



Dimensional drawing

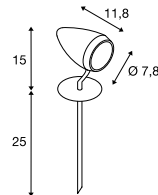

Tip

IP safety plug  
Earthspike included

Recommended lamp

LED GU10 4W 36°  
2700K 300lm  
4kWh/1000h  
Item No. 1004972



LED GU10 4W 36°  
3000K 300lm  
4kWh/1000h  
Item No. 1004973



Lamp details

max. 4W LED GU10 51mm  
Diameter: 5cm max. L: 5.7cm max.

Variant	Item No.
GU10   QPAR51 ■ stainless steel	231672

CV SPOT  
SP, long

SOCKET  
INSIDE



- Stainless steel 304

Product details

230V -50Hz  
Material: stainless steel 304

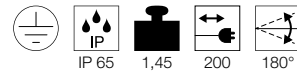

Dimensional drawing

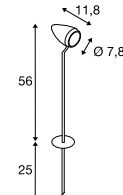

Tip

IP safety plug  
Earthspike included

Recommended lamp

LED GU10 3.7W 36°  
2700K 260lm  
4kWh/1000h  
Item No. 560122



LED GU10 4W 36°  
4000K 300lm  
4kWh/1000h  
Item No. 1004974



Lamp details

max. 4W LED GU10 51mm  
Diameter: 5cm max. L: 5.7cm max.

Variant	Item No.
GU10   QPAR51 ■ stainless steel	231682



229090 627

**NAUTILUS  
SP, QR-C51****SOCKET  
INSIDE**

- Stainless steel 304

**Product details**

12V ~50Hz

Material: stainless steel 304/glass



IP 67

1

150

180°

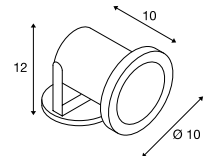
**Dimensional drawing****Accessory recommendation**

■ Transformer 12V AC | 60VA IP44

Item No. 227160



■ Transformer 12V AC | 105VA IP44

Item No. 227140

**Recommended lamp**

LED GU5.3 5.5W 36°

2700K 450lm

7kWh/1000h

Item No. 1001574



LED GU5.3 5.5W 36°

3000K 460lm

7kWh/1000h

Item No. 1001575

**Lamp details**

max. 35W QR-C51

Variant	Item No.
GX5.3   QR-C51	
■ stainless steel	229090



229741    629

NAUTILUS 10 SPOT SP, QPAR51



SOCKET INSIDE



• Stainless steel 316

Product details

230V -50Hz  
Material: stainless steel 316



Dimensional drawing

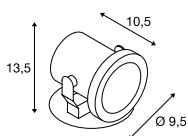

Tip

Open cable end

Accessory recommendation

■ Connection box IP68, 3-pole  
Item No. 228730



Recommended lamp

LED GU10 3.7W 36°  
2700K 260lm  
4kWh/1000h  
Item No. 560122



LED GU10 5.6W 60°  
2200-6700K 350lm  
6kWh/1000h  
Item No. 1001919



Lamp details

max. 25W QPAR51  
Diameter: 5 cm max. L: 6 cm max.

Variant	Item No.
■ stainless steel	229741

NAUTILUS 10 SPOT LED SP



LED INSIDE



• Stainless steel 316

Product details

220-240V ~50/60Hz  
Total wattage: 9W  
Material: stainless steel 316

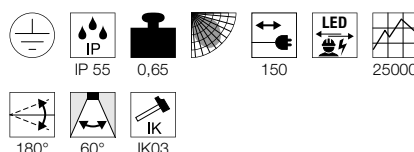

Dimensional drawing

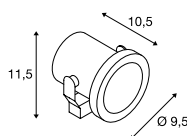

Tip

IP safety plug

Accessory recommendation

■ Mounting plate  
Item No. 1001963  
■ Plastic ground spike  
Item No. 900011



NAUTILUS SPOT SP, PAR38, E27



SOCKET INSIDE



• Stainless steel 304

Product details

230V -50Hz  
Material: stainless steel 304



Dimensional drawing

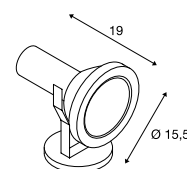

Tip

Open cable end

Accessory recommendation

■ Connection box IP68, 3-pole  
Item No. 228730



Recommended lamp

LED E27 17W 45°  
3000K 1430lm  
17kWh/1000h  
Item No. 560473



Lamp details

max. 80W PAR38  
optional: QPAR30

Variant	Item No.
■ stainless steel	229100

**DASAR® PROJECTOR**  
SP, 12/24V



**DASAR® PROJECTOR**  
SP, 230V



**Product details**

12V/24V DC  
Material: stainless steel 316/glass

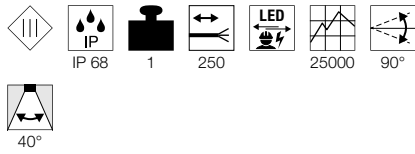

**Dimensional drawing**

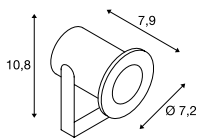

**Tip**

Open cable end

**Accessory recommendation**

- LED power supply 24V DC | 12W  
Item No. 470502
- LED power supply 12V DC | 12W  
Item No. 470507
- Stainless steel 316 ground spike  
Item No. 233580
- Stainless steel 316 mounting plate  
Item No. 233582
- Plastic ground spike  
Item No. 900011

Variant	Item No.
360lm   3000K   CRI>80	
<input checked="" type="checkbox"/> stainless steel	233570

**Product details**

220-240V ~50/60Hz | 400mA  
Total wattage: 5.5W  
Material: stainless steel 316/glass

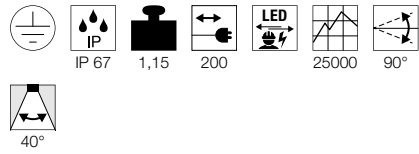

**Dimensional drawing**

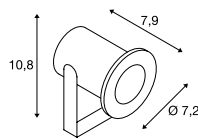

**Tip**

IP safety plug

**Accessory recommendation**

- Stainless steel 316 ground spike  
Item No. 233580
- Stainless steel 316 mounting plate  
Item No. 233582
- Plastic ground spike  
Item No. 900011

Variant	Item No.
300lm   3000K   CRI>80	
<input checked="" type="checkbox"/> stainless steel	233571

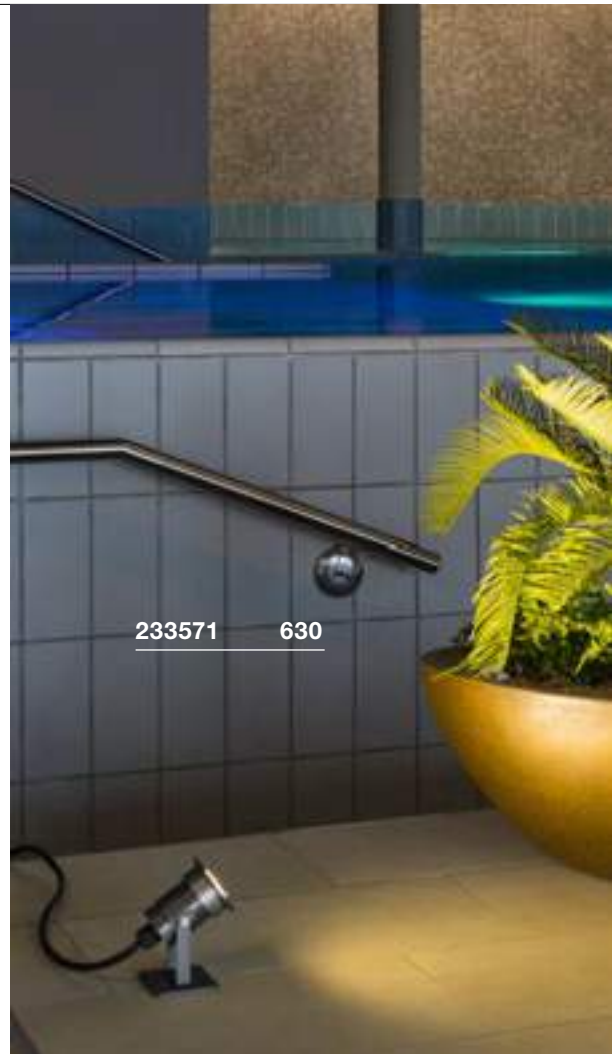



1000735 631



1000735 631



228555 631

HELIA SPOT S  
SP, single, PHASE



HELIA SPOT L  
SP, single, PHASE



• High-voltage LED

Product details

220-240V ~50/60Hz  
Total wattage: 8W  
Material: aluminium  
Dimmable: C, L

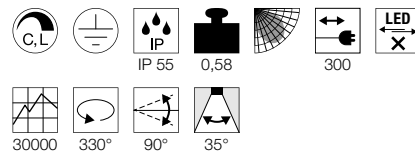

Dimensional drawing

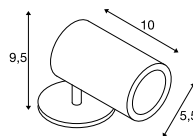

Tip

IP safety plug

Product details

220-240V ~50/60Hz  
Total wattage: 17W  
Material: aluminium/glass  
Dimmable: C, L

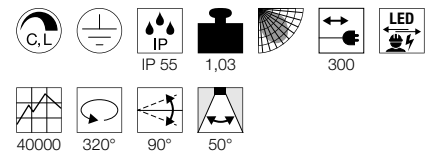

Dimensional drawing

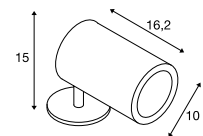

Tip

IP safety plug

Accessory recommendation

■ Ground spike  
Item No. 1000736



Variant	Item No.
480lm   3000K   CRI>80 ■ anthracite	1000735

Accessory recommendation

■ Ground spike  
Item No. 228560



Variant	Item No.
1050lm   3000K   CRI>80 ■ anthracite	228555



232840 633

LOUNGE  
VVCCID



SPOODI 31  
SP



Product details

230V ~50Hz  
Total wattage: 60W  
Material: aluminium/glass

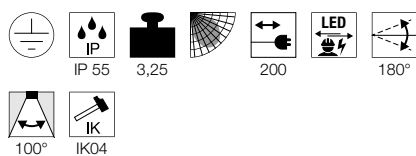

Dimensional drawing

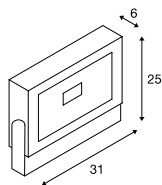

Tip

IP safety plug

Accessory recommendation

- Wall bracket 50cm  
Item No. 234340
- Wall bracket 80cm  
Item No. 234350

Variant	Item No.
5100lm   3000K   CRI>80 ■ black	232840 ▼

SPOODI 13  
SP, SENSOR



Product details

220-240V ~50/60Hz  
Total wattage: 11W  
Material: aluminium/glass

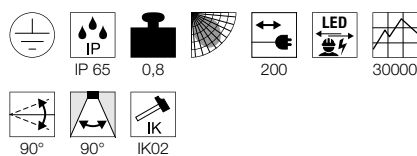

Dimensional drawing

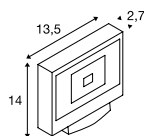

Tip

Detection angle 110°, max. detection distance 8m, day/night mode, adjustable operating time  
IP safety plug  
Remote control included

Variant	Item No.
800lm   3000K   CRI>80 ■ black	232860 ▼
800lm   3000K   CRI>80 ■ grey	232864 ▼
870lm   4000K   CRI>80 ■ black	232870 ▼
870lm   4000K   CRI>80 ■ grey	232874 ▼

SPOODI 20  
SP, SENSOR



Product details

220-240V ~50/60Hz  
Total wattage: 30W  
Material: aluminium/glass

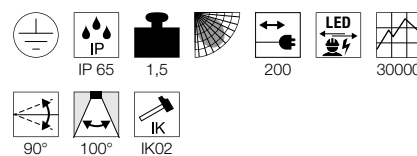

Dimensional drawing

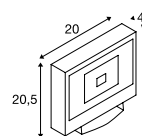

Tip

Detection angle 110°, max. detection distance 8m, day/night mode, adjustable operating time  
IP safety plug  
Remote control included

Variant	Item No.
2250lm   3000K   CRI>80 ■ black	232880 ▼
2250lm   3000K   CRI>80 ■ grey	232884 ▼
2500lm   4000K   CRI>80 ■ black	232890 ▼
2500lm   4000K   CRI>80 ■ grey	232894 ▼

## FLAC BEAM® SP

LED  
INSIDE



### Product details

220-240V ~50/60Hz  
Total wattage: 27W  
Material: aluminium

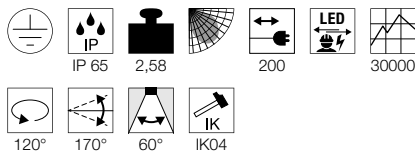

### Dimensional drawing

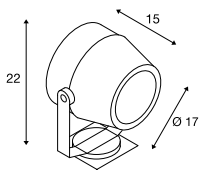

### Tip

IP safety plug



231072 634

Variant	Item No.
1800lm   3000K   CRI>80 ■ grey	231072



227734 635

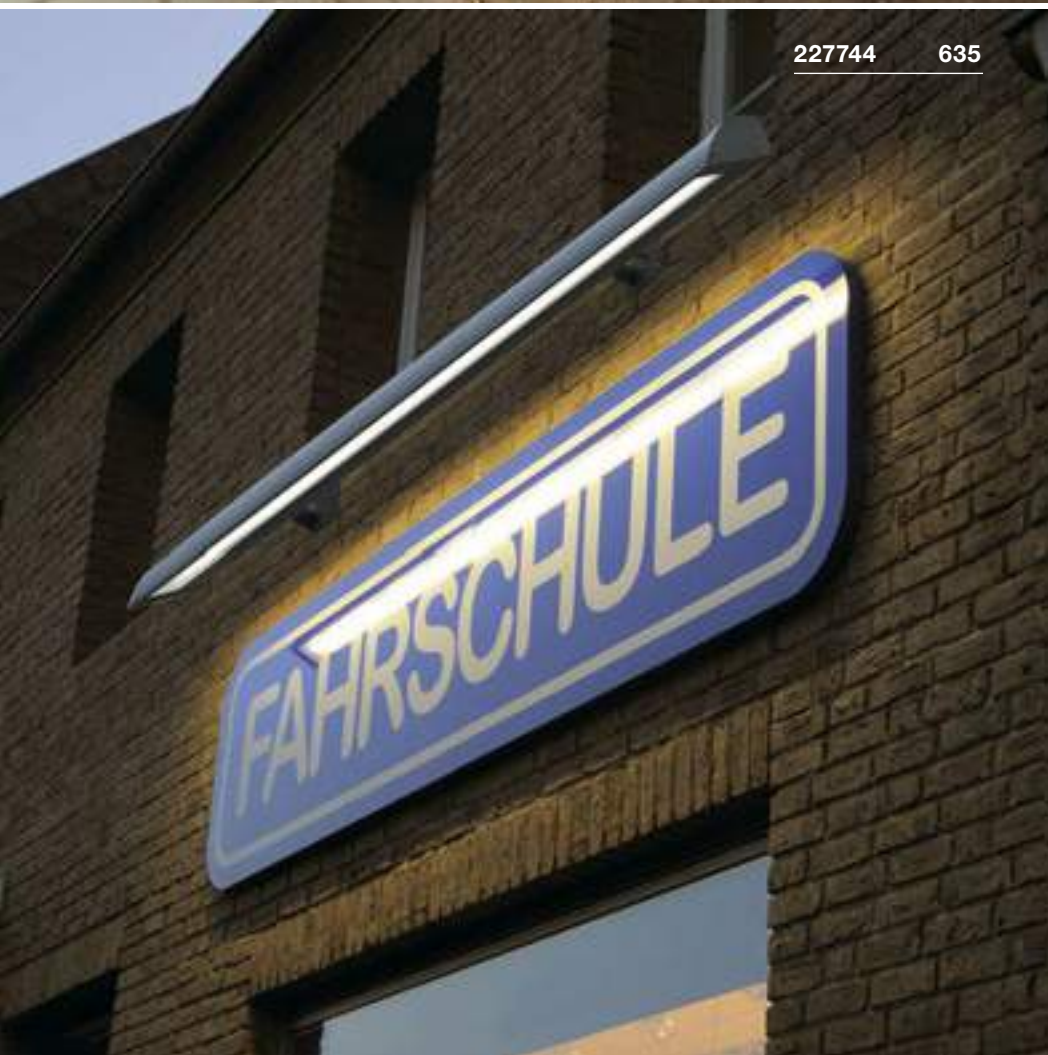

227744 635

VANO WING  
SP, 1-10V



- Asymmetrical light distribution
- For even illumination of vertical areas

Product details

120-277V ~50/60Hz | 525mA  
Material: aluminium/glass  
Dimmable: 1-10V

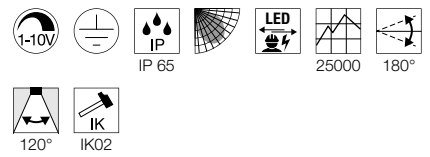

Dimensional drawing

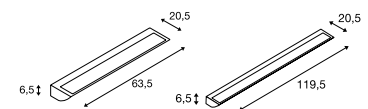

Variant	Item No.
1500lm   3000K   CRI>80 35W   W: 63.5 cm   3.29 kg ■ grey	227734
3340lm   3000K   CRI>80 48W   W: 119.5 cm   6 kg ■ grey	227744

GALEN 100  
SP

## Product details

24V DC

Total wattage: 25W

Material: aluminium/glass



IP 65

1,5

150

LED

30000



120°

## Dimensional drawing

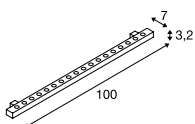

## Tip

Open cable end

## Accessory recommendation

LED power supply 24V DC | 36W

Item No. 470544



LED power supply 24V DC | 60W

Item No. 470506



Variant	Item No.
1070lm   6500K   CRI>70	
grey	229481
970lm   3000K   CRI>70	
grey	229482

229482

636





1003448 637

GALEN 60/120  
SP



- The light colour can be selected during installation using a switch

Product details

220-240V ~50/60Hz | 900mA  
Material: aluminium/glass



10

Dimensional drawing

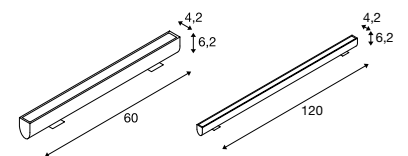

Accessory recommendation

■ Connection cable 5m

Item No. 231960



■ Connection cable 1.5m

Item No. 231961



Variant	Item No.
1570/1570lm   3000/4000K   CRI>80   18W L: 60cm   1.4 kg	■ anthracite 1003447
3000/3100lm   3000/4000K   CRI>80   34W L: 120cm   2.5 kg	■ anthracite 1003448

# BRINGING LIGHT INTO THE DARK.

## PRACTICAL WALL AND CEILING LIGHTS.

---

They beam out, even under the worst weather conditions: Our wall and ceiling lights are robust, energy-efficient and powerful. However, as well as all of the functionality you can also choose between different designs. Do you prefer modern? Traditional? Round? Or would you like square?





1002902 688



WALL AND CEILING LIGHTS

							
642	642	642	644	645	646	646	647
							
648	648	948	650	650	651	651	652
							
653	654	655	655	656	656	657	657
							
658	658	659	659	660	661	662	663
							
663	664	664	665	665	666	666	667
							
667	667	668	669	669	669	670	670
							
671	671	672	672	673	374	675	675
							
676	676	677	678	679	680	680	680



								
681	681	682	683	683	684	684	684	684
								
685	685	685	686	687	687	687	688	688
								
688	689	689	690	690	691	691	692	692
								
693	693	694	695	696	696	696	697	697
								
697	697	698	699	700	700	700	701	701
								
702	702	703	704	705	705	705	706	706
								
706	706	707	709	709	710	710	710	710
								
711	712	712	713	713	714	715	715	715
								
716	717	717	717	718	719	719	720	720
								
720	720	721	721	722	722	722	723	723
								
723								

 Other luminaires and variants can be found online at [www.slv.com](http://www.slv.com)  
 You can find manufacturer's details for our recommended lamps in the chapter 'Lightbulbs', from page 844

**PHOTONIA**  
WL, E27



SOCKET  
INSIDE



**GLOO PURE**  
WL, E27



SOCKET  
INSIDE



**MOLAT**  
WL, E27



SOCKET  
INSIDE

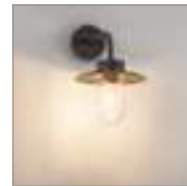

**Product details**

220-240V ~50/60Hz  
Material: aluminium/glass



**Dimensional drawing**

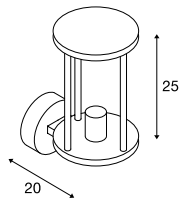

**Product details**

230V -50Hz  
Material: aluminium/glass



**Dimensional drawing**

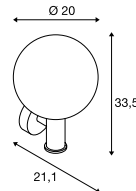

**Product details**

230V ~50/60Hz  
Material: aluminium/glass

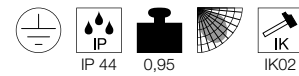

**Dimensional drawing**

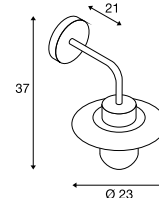

**Recommended lamp**

LED E27 5W 330°  
2000K 500lm  
5kWh/1000h  
Item No. 560741



LED E27 7W 280°  
2700K 790lm  
7kWh/1000h  
Item No. 1002127



**Recommended lamp**

LED E27 9W 240°  
3000K 810lm  
10kWh/1000h  
Item No. 1001031



LED E27 9W 240°  
4000K 850lm  
9kWh/1000h  
Item No. 1002827



**Recommended lamp**

LED E27 7W 280°  
2700K 790lm  
7kWh/1000h  
Item No. 1002127



LED E27 7W  
2700K 810lm  
7kWh/1000h  
Item No. 1003090



**Lamp details**

max. 60W  
Diameter: 9 cm max. L: 15 cm max.

**Lamp details**

max. 23 W  
Diameter: 4.8 cm max. L: 18 cm max.

**Lamp details**

max. 60W  
Diameter: 6.5 cm max. L: 14.5 cm max.

Variant	Item No.
E27	
■ anthracite	232045

Variant	Item No.
E27	
■ anthracite	1002002

Variant	Item No.
E27	
■ anthracite	1000820

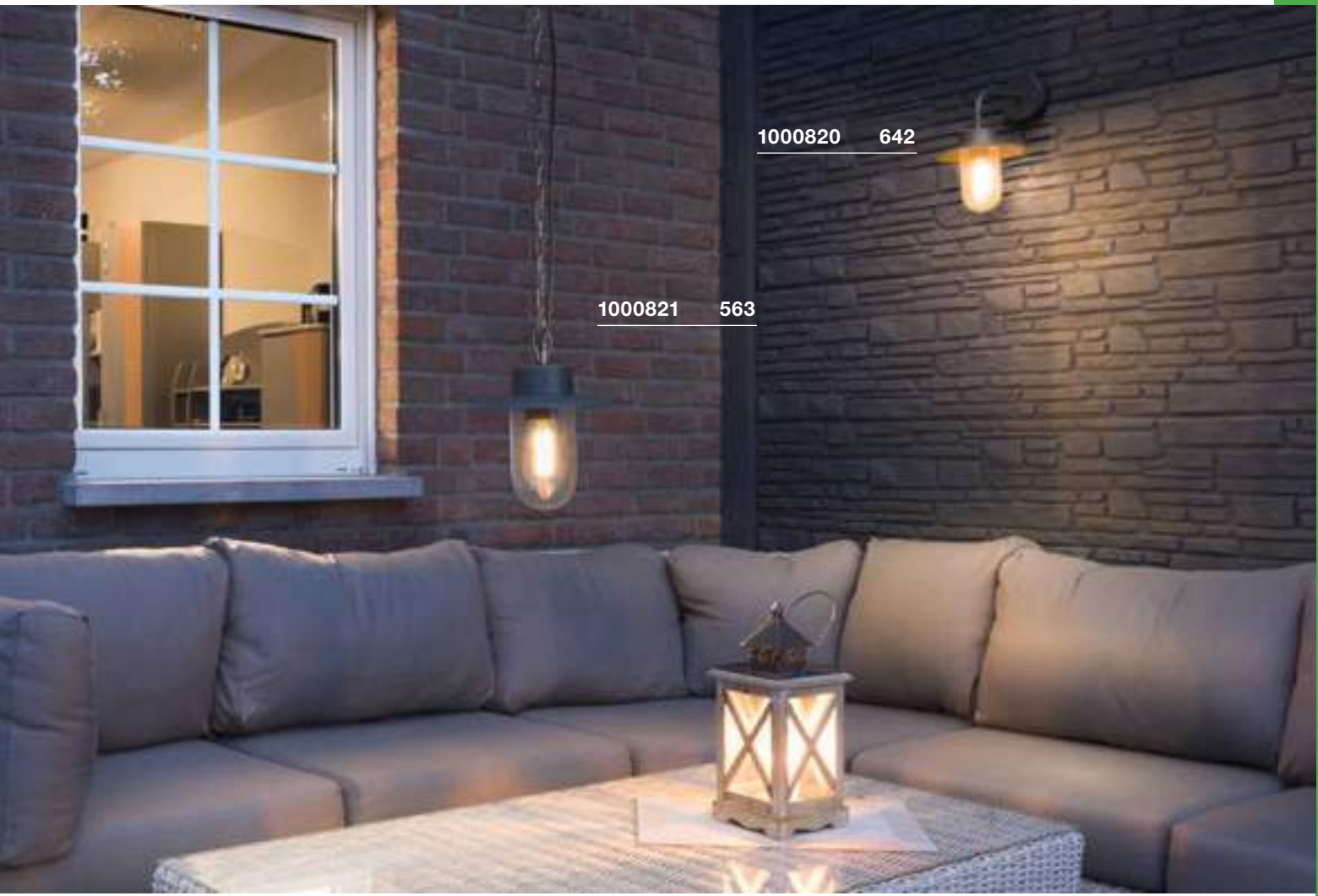

1000820 642

1000821 563



232045 642

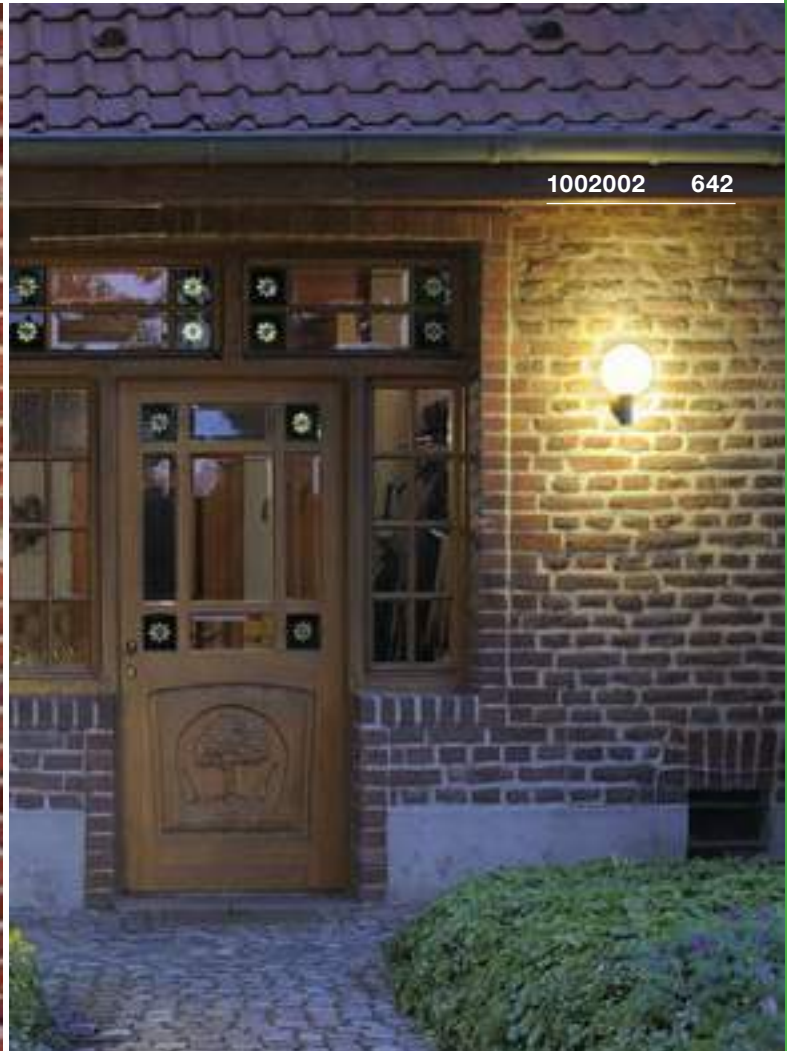

1002002 642

SLOTS  
WL



LED  
INSIDE



Product details

220-240V ~50/60Hz  
Total wattage: 6.3W  
Material: aluminium/glass

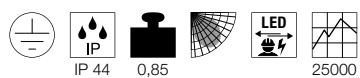

Dimensional drawing

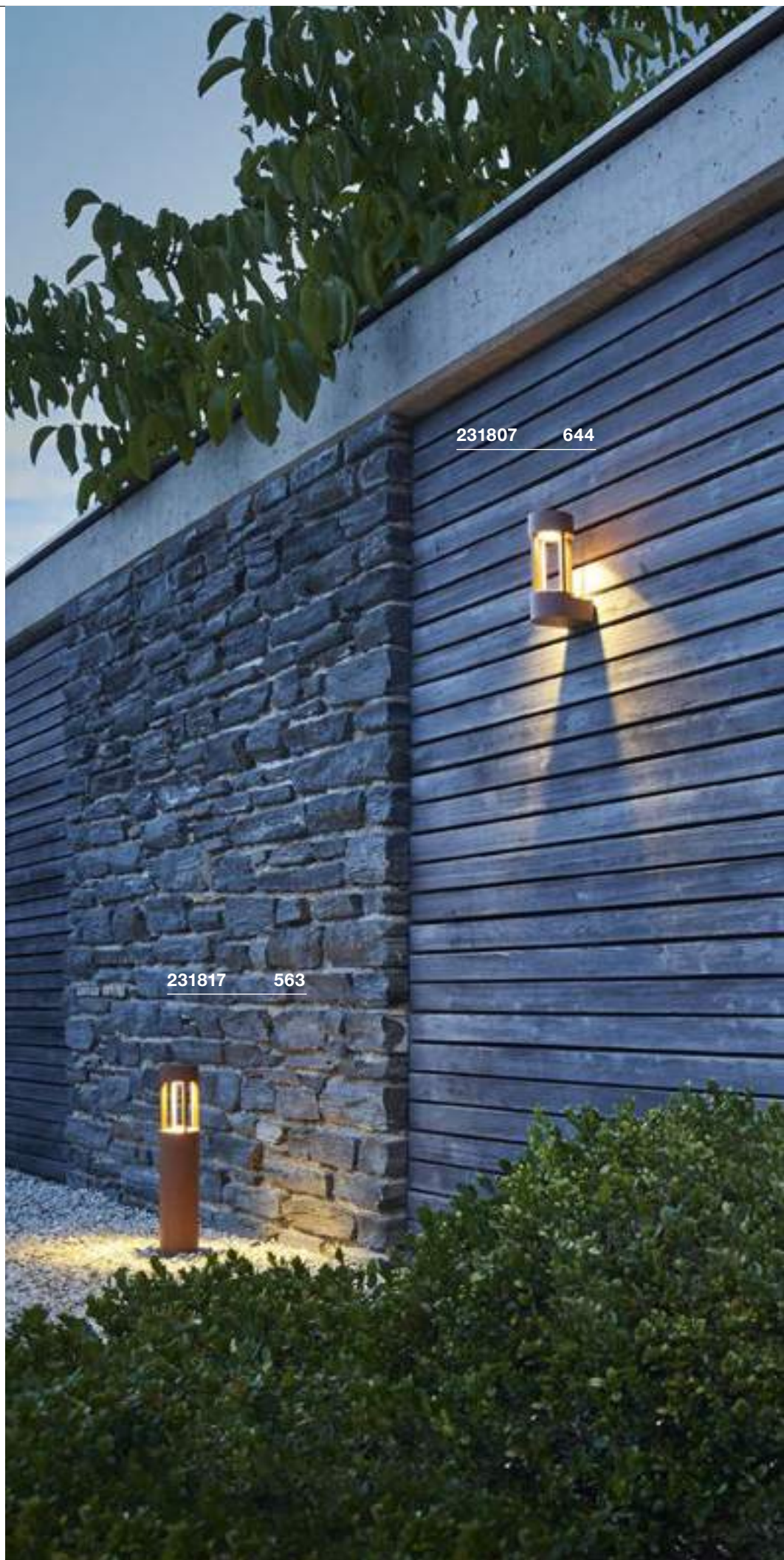
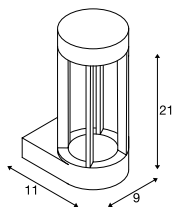

Variant	Item No.
140lm   3000K   CRI>80	
■ anthracite	231805
140lm   3000K   CRI>80	
■ rust	231807



1000681 645

1000682 577

APONI  
WL, PHASE



LED  
INSIDE



- High-voltage LED

Product details

220-240V ~50/60Hz  
Total wattage: 8W  
Material: aluminium  
Dimmable: L



Dimensional drawing

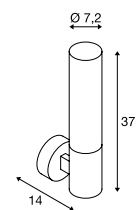

Variant	Item No.
440lm   3000K   CRI>80 ■ anthracite	1000681

F-POL  
WL, E27



C-POL  
WL, E27



SOCKET  
INSIDE



SOCKET  
INSIDE



- High-polish reflector for effective illumination
- Diffuse light distribution to illuminate your building environment

- High-polish reflector for effective illumination
- Diffuse light distribution to illuminate your building environment

Product details

230V -50Hz  
Material: aluminium/polycarbonate (PC)

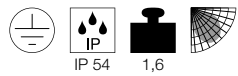

Product details

230V -50Hz  
Material: aluminium/polycarbonate (PC)

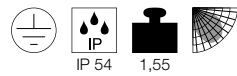

Dimensional drawing

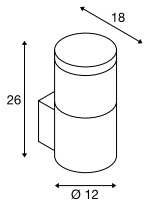

Dimensional drawing

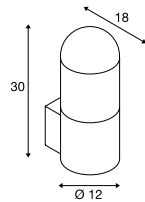

Recommended lamp

LED E27 9W 240°  
4000K 850lm  
9kWh/1000h  
Item No. 1002827



LED E27 9W 240°  
3000K 810lm  
10kWh/1000h  
Item No. 1001031



Recommended lamp

LED E27 15W 240°  
4000K 1600lm  
15kWh/1000h  
Item No. 1002828



LED E27 15W 240°  
3000K 1521lm  
15kWh/1000h  
Item No. 1001033



Lamp details

max. 20W  
Diameter: 5 cm max. L: 14 cm max.

Lamp details

max. 24 W  
Diameter: 5.2 cm max. L: 17.3 cm max.

Variant	Item No.
E27	
■ anthracite	231585

Variant	Item No.
E27	
■ anthracite	231465



231585 646



231465 646



229182 647



## BIG NAILS WL, E27



SOCKET  
INSIDE



- Stainless steel 304
- Slim design, glare-free outdoor illumination

### Product details

230V -50Hz

Material: stainless steel 304/polycarbonate (PC)



IP 44

1,2

### Dimensional drawing

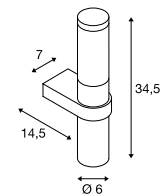

### Recommended lamp

LED E27 9W 240°  
3000K 810lm  
10kWh/1000h  
**Item No. 1001031**



LED E27 9W 240°  
4000K 850lm  
9kWh/1000h  
**Item No. 1002827**



### Lamp details

max. 15W

Diameter: 4.5 cm max. L: 17 cm max.

Variant	Item No.
E27	
■ stainless steel	<b>229182</b>

GRAFIT  
WL, E27



SOCKET  
INSIDE



SQUARE  
WL, E27



SOCKET  
INSIDE



SQUARE  
WL, PHASE



LED  
INSIDE



- Lights made from high-quality 316 stainless steel
- Modern design
- Diffuse light distribution to illuminate your building environment

Product details

230V -50Hz  
Material: aluminium/plastic

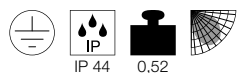

Product details

220-240V ~50/60Hz  
Material: stainless steel 304



Product details

220-240V ~50/60Hz  
Total wattage: 12W  
Material: stainless steel 316  
Dimmable: C, L

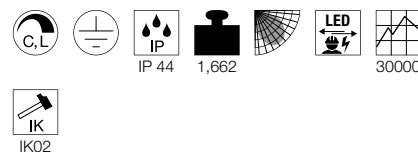

Dimensional drawing

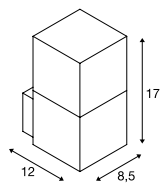

Dimensional drawing

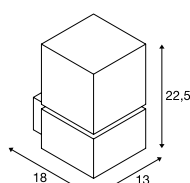

Dimensional drawing

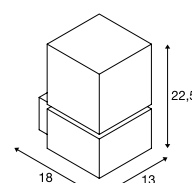

Recommended lamp

LED E27 7W  
2700K 810lm  
7kWh/1000h  
Item No. 1003090



LED E27 7W 280°  
2700K 790lm  
7kWh/1000h  
Item No. 1002124



Recommended lamp

LED E27 9.1W 240°  
2700K 760lm  
10kWh/1000h  
Item No. 560402



LED E27 14.5W 200°  
2700K 1521lm  
15kWh/1000h  
Item No. 560422



Lamp details

max. 11W  
Diameter: 6 cm max. L: 11.5 cm max.

Lamp details

max. 20W  
Diameter: 7 cm max. L: 13 cm max.

Variant	Item No.
E27	
■ anthracite	231205

Variant	Item No.
E27	
■ stainless steel	1000336

Variant	Item No.
760lm   3000K   CRI>80	
■ stainless steel	1000834



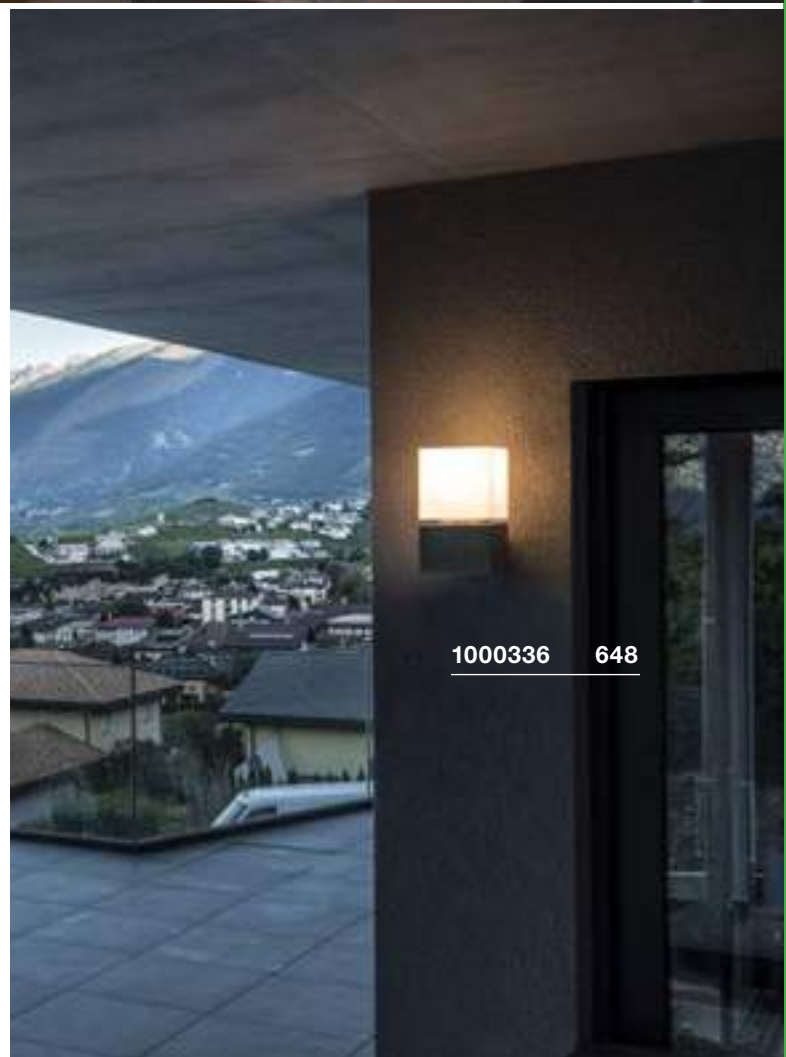

OVALISK  
WL



- The light colour can be selected during installation using a switch

Product details

100-240V ~50/60Hz | 500mA  
Total wattage: 9W  
Material: aluminium/glass

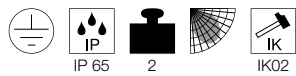

Dimensional drawing

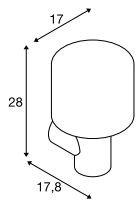

OVALISK SENSOR  
WL



- The light colour can be selected during installation using a switch
- With motion sensor

Product details

100-240V ~50/60Hz | 500mA  
Total wattage: 9.6W  
Material: aluminium/glass



Dimensional drawing

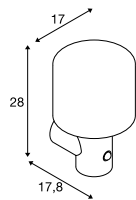

1004679 650

Variant	Item No.
560/600lm   3000/4000K   CRI>80	
■ anthracite	1004678

Variant	Item No.
560/600lm   3000/4000K   CRI>80	
■ anthracite	1004679





227174 651



230445 651

**KERAS ELT**  
WL, E27

SOCKET  
INSIDE



- Unusual design

**Product details**

230V -50Hz  
Material: aluminium/polycarbonate (PC)

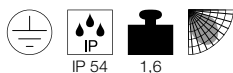

**Dimensional drawing**

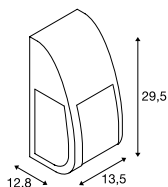

**Recommended lamp**

LED E27 14.5W 200°  
2700K 1521lm  
15kWh/1000h  
Item No. 560422



LED E27 15W 240°  
4000K 1600lm  
15kWh/1000h  
Item No. 1002828



**Lamp details**

max. 25W  
Diameter: 7 cm max. L: 17.5 cm max.

Variant	Item No.
E27	
■ grey	227174
E27	
■ anthracite	227176

**MERIDIAN**  
WL, E27

SOCKET  
INSIDE

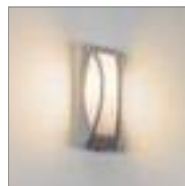

**Product details**

230V -50Hz  
Material: aluminium/polycarbonate (PC)

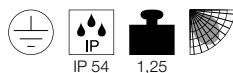

**Dimensional drawing**

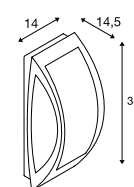

**Recommended lamp**

LED E27 9.1W 240°  
2700K 760lm  
10kWh/1000h  
Item No. 560402



LED E27 7W  
2700K 810lm  
7kWh/1000h  
Item No. 1003090



**Lamp details**

max. 25W  
Diameter: 7 cm max. L: 17.5 cm max.

Variant	Item No.
E27	
■ grey	230444
E27	
■ anthracite	230445

## QUADRULO SENSOR WL, E27

SOCKET  
INSIDE



### Product details

230V -50Hz  
Material: aluminium/glass



IP 44 2,24

### Dimensional drawing

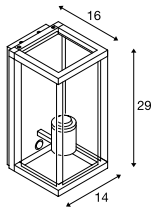

1002402 652

### Recommended lamp

LED E27 7W 280°  
2700K 790lm  
7kWh/1000h  
Item No. 1002124



LED E27 5W 330°  
2000K 500lm  
5kWh/1000h  
Item No. 560741



### Lamp details

max. 15W  
Diameter: 8 cm max. L: 18 cm max.

Variant	Item No.
E27	
■ anthracite	1002402





1002403 653

## QUADRULO WL, E27

SOCKET  
INSIDE



### Product details

230V -50Hz  
Material: aluminium/glass



IP 44

2,21

### Dimensional drawing

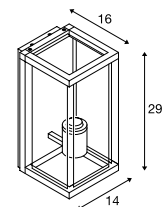

### Recommended lamp

LED E27 7.1W 330°  
2700K 806lm  
8kWh/1000h  
Item No. 1001756



LED E27 7W 280°  
2700K 790lm  
7kWh/1000h  
Item No. 1002127



### Lamp details

max. 15W  
Diameter: 8 cm max. L: 18 cm max.

Variant	Item No.
E27	
■ anthracite	1002403

## MERIDIAN BOX WL, E27

SOCKET  
INSIDE



### Product details

230V -50Hz

Material: aluminium/polycarbonate (PC)

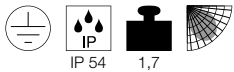

IP 54

1,7

### Dimensional drawing

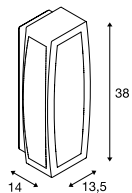

### Recommended lamp

LED E27 7.1W 330°  
2700K 806lm  
8kWh/1000h

Item No. 1001756



LED E27 5W 330°  
2000K 500lm  
5kWh/1000h

Item No. 560741



### Lamp details

max. 25W

Diameter: 7 cm max. L: 17.5 cm max.

Variant	Item No.
E27	
■ anthracite	230655
■ rust	230657



230655

654

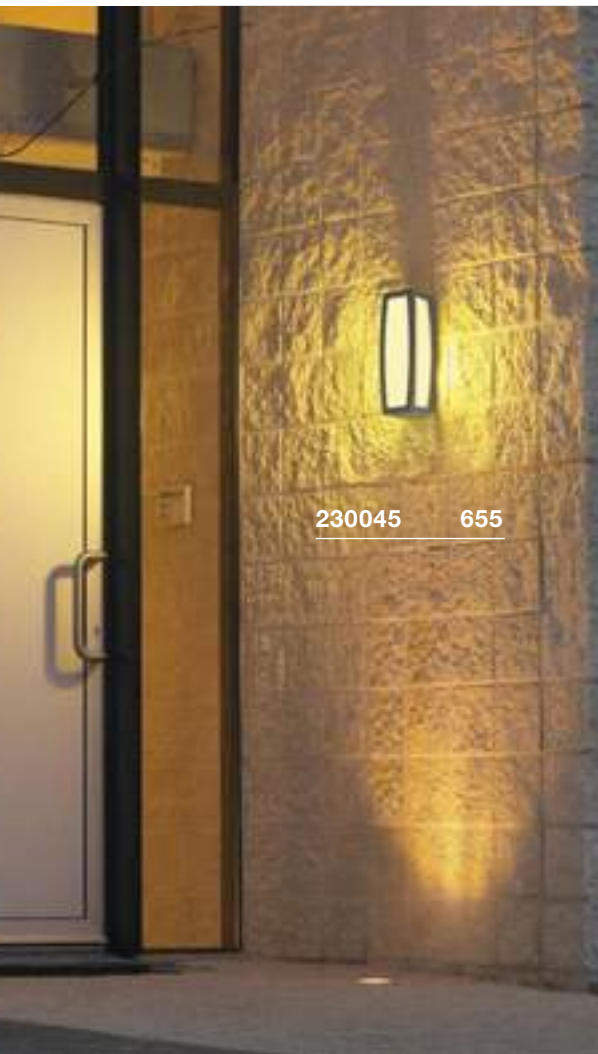

**MERIDIAN BOX**  
WL, E27

SOCKET  
INSIDE



**Product details**

230V -50Hz  
Material: aluminium/polycarbonate (PC)

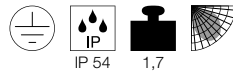

**Dimensional drawing**

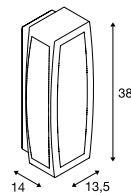

**Recommended lamp**

LED E27 15W 240°  
3000K 1521lm  
15kWh/1000h  
Item No. 1001033



LED E27 15W 240°  
4000K 1600lm  
15kWh/1000h  
Item No. 1002828



**Lamp details**

max. 25W  
Diameter: 7 cm max. L: 17.5 cm max.

Variant	Item No.
E27	
■ grey	230044
E27	
■ anthracite	230045

**MERIDIAN BOX SENSOR**  
WL, E27

SOCKET  
INSIDE



- Motion detector with MR (microwave) technology integrated in the light housing

**Product details**

230V -50Hz  
Material: aluminium/polycarbonate (PC)

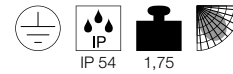

**Dimensional drawing**

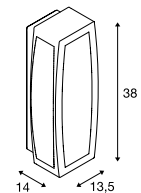

**Tip**

Motion sensor: Detection angle: 180°  
Detection range: 1-5 m  
The ambient brightness and operational time can be adjusted.

**Recommended lamp**

LED E27 9W 240°  
3000K 810lm  
10kWh/1000h  
Item No. 1001031



LED E27 15W 240°  
3000K 1521lm  
15kWh/1000h  
Item No. 1001033



**Lamp details**

max. 25W  
Diameter: 7 cm max. L: 17.5 cm max.

Variant	Item No.
E27	
■ grey	230084
E27	
■ anthracite	230085

SITRA  
WL, TCR-TSE



SITRA  
WL



SOCKET  
INSIDE



LED  
INSIDE



230355 656

Product details

230V -50Hz  
Material: aluminium/glass

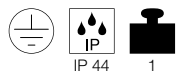

Product details

220-240V ~50/60Hz  
Total wattage: 9W  
Material: aluminium/glass

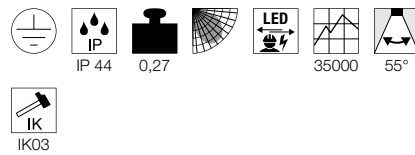

Dimensional drawing

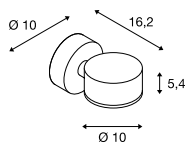

Dimensional drawing

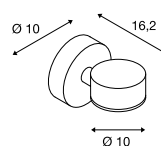

Recommended lamp

LED GX53 4.2W 35°  
3000K 200lm  
5kWh/1000h  
Item No. 550092



LED GX53 8.2W 120°  
3000K 600lm  
9kWh/1000h  
Item No. 550073



Lamp details

max. 9W TCR-TSE  
Diameter: 7.5 cm max. L: 3.5 cm max.

Variant	Item No.
GX53   TCR-TSE ■ anthracite	230355

Variant	Item No.
450lm   3000K   CRI>80 ■ anthracite	100216
450lm   3000K   CRI>80 □ white	1002017

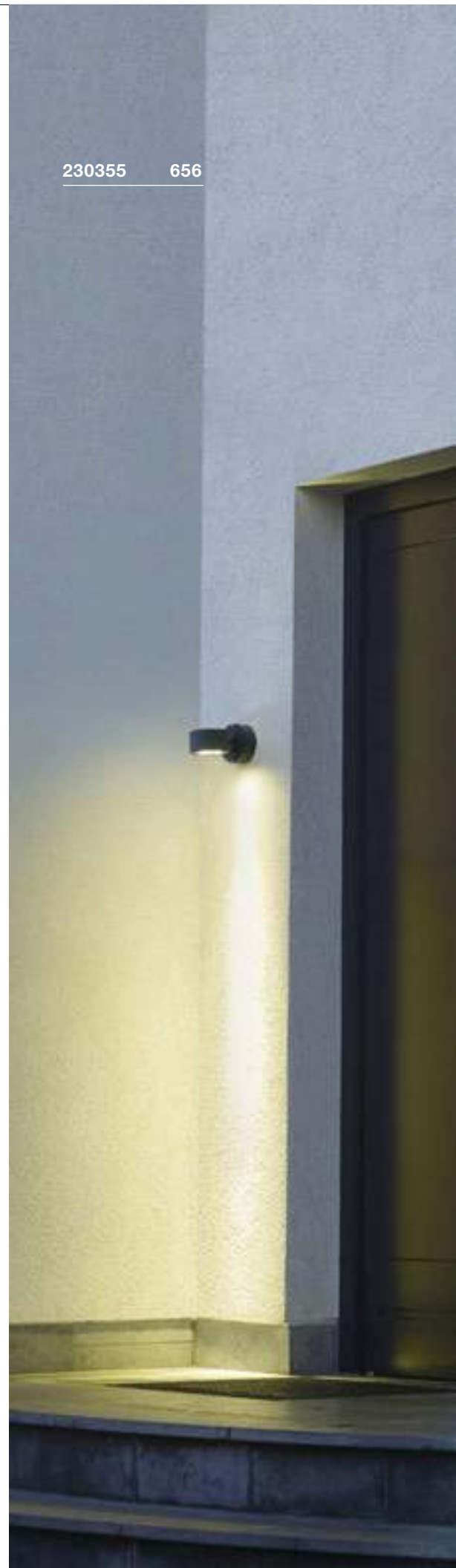





1000333 657



1000448 657

**ROX**  
WL, QPAR111



**SOCKET**  
**INSIDE**



- High-quality brushed surface

**Product details**

230V -50Hz  
Material: aluminium/glass

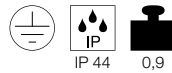

**POLE PARC**  
WL



**LED**  
**INSIDE**



- Perfectly suitable for the effective accentuation of building architecture
- Rotationally symmetrical light distribution

**Product details**

100-240V ~50/60Hz | 700mA  
Total wattage: 28W  
Material: aluminium/glass

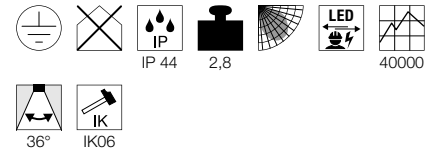

**Dimensional drawing**

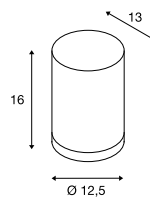

**Dimensional drawing**

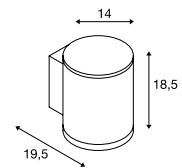

**Recommended lamp**

LED GU10 13W 30°  
4000K 1100lm  
13kWh/1000h  
**Item No. 1003087**



LED GU10 7,3W 13°  
2700K 660lm  
8kWh/1000h  
**Item No. 1000939**



**Lamp details**

max. 50W QPAR111

Variant	Item No.
GU10   QPAR111	
aluminium	1000333

Variant	Item No.
2900lm   3000K   CRI>80	
anthracite	1000448

**DOWNUNDER OUT**  
Round



- The light colour can be selected during installation using a switch

**Product details**

100-277V ~50/60Hz | 500mA  
Total wattage: 4.5W  
Material: aluminium



**Dimensional drawing**

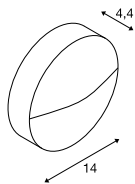

**DOWNUNDER OUT**  
Square



- The light colour can be selected during installation using a switch

**Product details**

100-277V ~50/60Hz | 500mA  
Total wattage: 4.5W  
Material: aluminium



**Dimensional drawing**

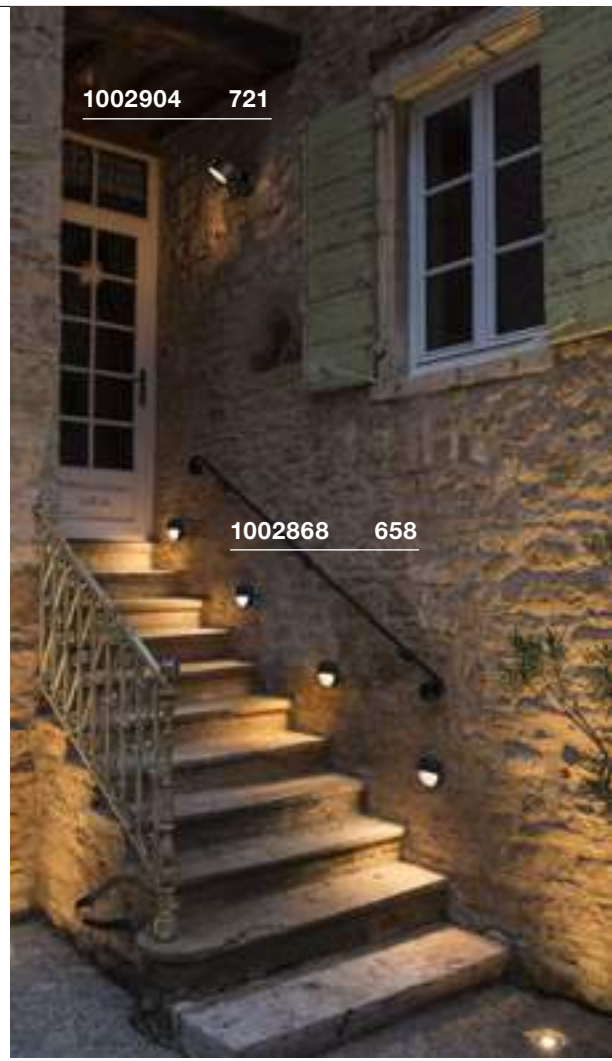
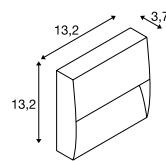

Variant	Item No.
140lm   3000/4000K   CRI>80 ■ anthracite	1002868

Variant	Item No.
150lm   3000/4000K   CRI>80 ■ anthracite	1002869



231010 659

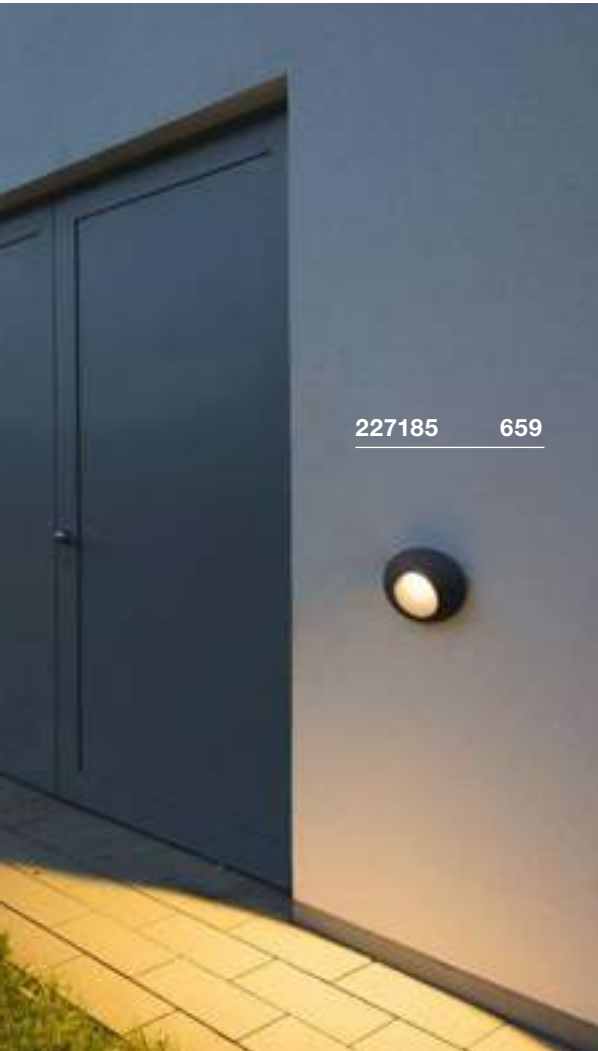

227185 659

PEMA®  
WL



Product details

230V -50Hz  
Total wattage: 4.7W  
Material: aluminium



Dimensional drawing

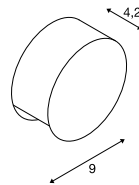

Tip

Protection rating IP44 only when mounted with light emission downwards.

Variant	Item No.
125lm   3000K   CRI>80 □ white	231010
125lm   3000K   CRI>80 ■ grey	231012
125lm   3000K   CRI>80 ■ anthracite	231015

DELO  
WL



Product details

100-240V ~50/60Hz | 500mA  
Total wattage: 5.8W  
Material: aluminium/glass



Dimensional drawing

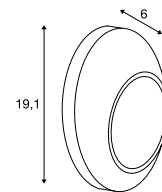

Tip

Protection rating IP55 only when mounted with mission downwards.

Variant	Item No.
170lm   3000K   CRI>80 ■ anthracite	227185

RASCALI  
WL



LED  
INSIDE



- Unusual design
- Aesthetic accentuation of outdoor areas

#### Product details

220-240V ~50Hz  
Total wattage: 8W  
Material: aluminium



IP 54



0,85



LED  
X



30000



IK02

#### Dimensional drawing

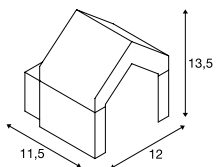

1000797 660



Variant	Item No.
330lm   3000K   CRI>80	
■ anthracite	1000797

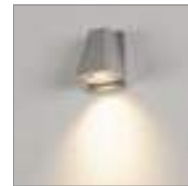

227195 661

WALLYX  
WL, QPAR51SOCKET  
INSIDE

## Product details

220-240V ~50/60Hz  
Material: aluminium/glass



IP 44

0,67

## Dimensional drawing

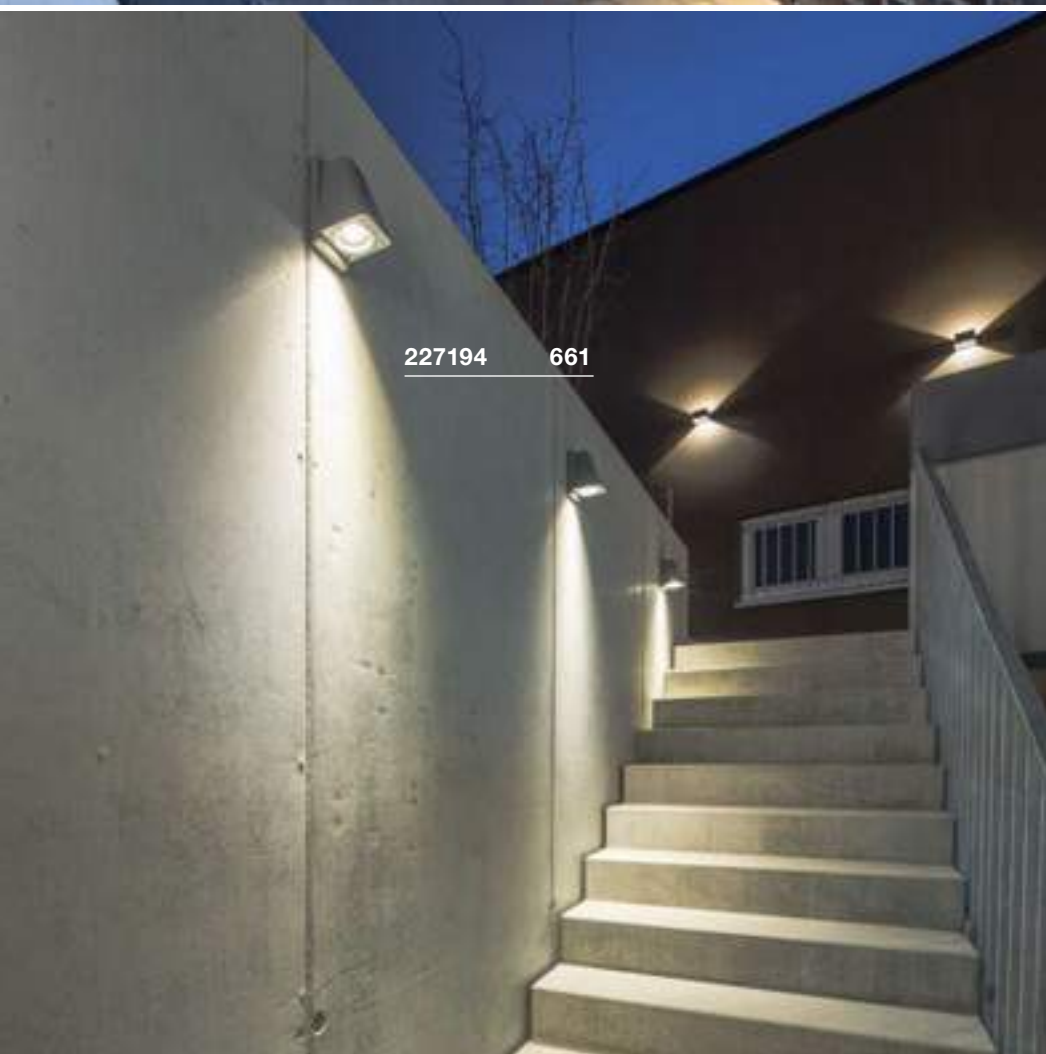
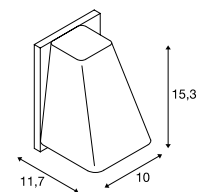

227194 661

## Recommended lamp

LED GU10 4W 36°  
2700K 300lm  
4kWh/1000h  
Item No. 1004972



LED GU10 4W 36°  
3000K 300lm  
4kWh/1000h  
Item No. 1004973



## Lamp details

max. 50W QPAR51  
L: 7.6 cm max.

Variant	Item No.
GU10   QPAR51 ■ grey	227194
GU10   QPAR51 ■ anthracite	227195
GU10   QPAR51 ■ bronze	227198



reddot award 2018  
winner



231865

662

**DESIGNED BY**  
Carsten Witsch



"Form, function, processing and ease of use should be harmonious in a product. Good design is characterized not only by the appearance of the products, but also by its functionality."

BENDO  
WL, PHASE



reddot award 2018  
winner



- High-voltage LED

**Product details**

220-240V ~50/60Hz  
Total wattage: 12W  
Material: aluminium/glass  
Dimmable: C, L

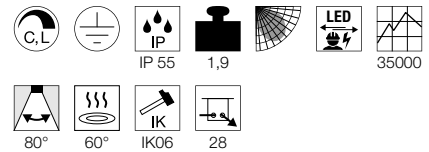

**Dimensional drawing**

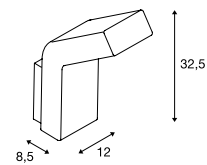

Variant	Item No.
820lm   3000K   CRI>80 ■ anthracite	231865



1004747 663

ESKINA FRAME  
WL

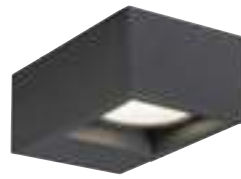

- The light colour can be selected during installation using a switch

Product details

220-240V ~50/60Hz | 350mA  
Total wattage: 15W  
Material: aluminium  
Dimmable: C

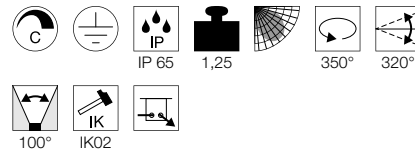

Dimensional drawing

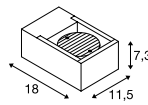

ESKINA FRAME  
WL, double

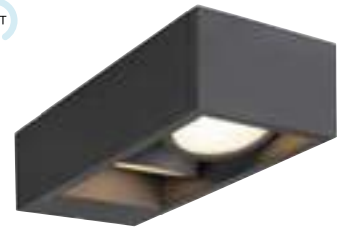

- The light colour can be selected during installation using a switch

Product details

220-240V ~50/60Hz | 700mA  
Total wattage: 27W  
Material: aluminium

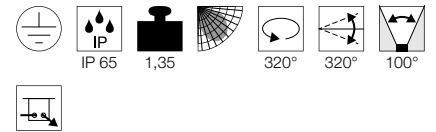

Dimensional drawing

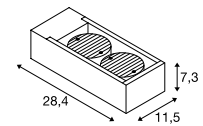

Variant	Item No.
1100/1200lm   3000/4000K   CRI>80 ■ anthracite	1004747

Variant	Item No.
Spot 1: 1100/1200lm   3000/4000K   CRI>80 Spot 2: 1100/1200lm   3000/4000K   CRI>80 ■ anthracite	1004748

**ABRIDOR**  
WL



**ABRIDOR SENSOR**  
WL



- The light colour can be selected during installation using a switch
- Pivoting light head

- The light colour can be selected during installation using a switch
- Pivoting light head
- With integrated infrared movement sensor

**Product details**

100-277V ~50/60Hz | 300mA  
Total wattage: 14W  
Material: aluminium

**Product details**

100-277V ~50/60Hz | 500mA  
Total wattage: 14W  
Material: aluminium



**Dimensional drawing**

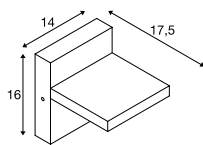

**Dimensional drawing**

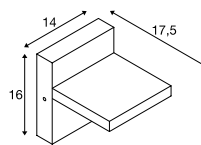

**Tip**

Sensor range adjustable from 6m to 9m, detection angle 120°

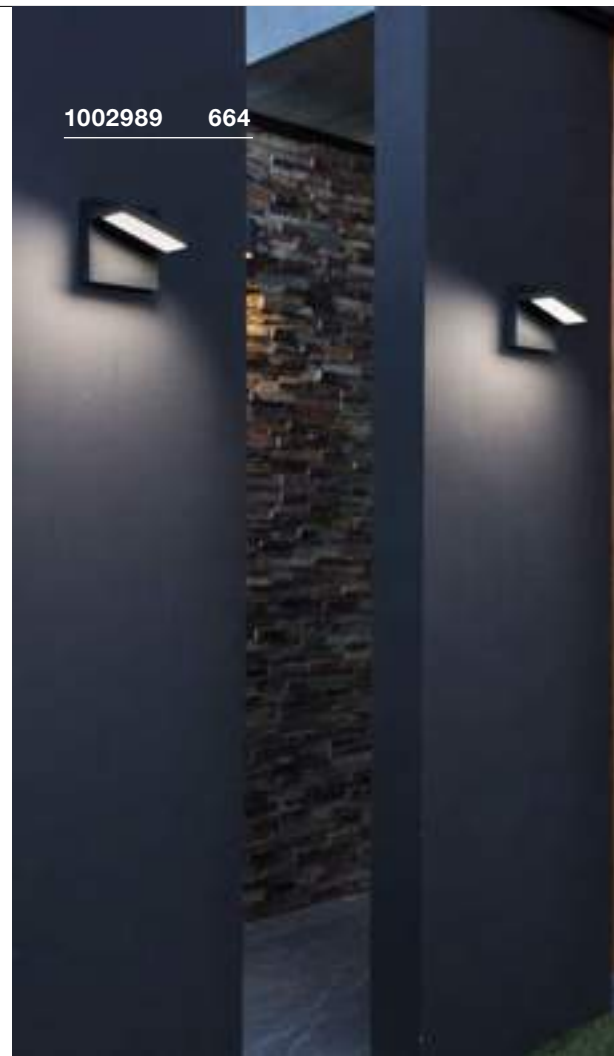

Variant	Item No.
750lm   3000/4000K   CRI>80 ■ anthracite	<b>1002989</b>

Variant	Item No.
750lm   3000/4000K   CRI80 ■ anthracite	<b>1002990</b>





1002953 665

FLATT  
WL



- The light colour can be selected during installation using a switch

Product details

100-277V ~50/60Hz | 300mA  
Total wattage: 14W  
Material: aluminium/aluminium



Dimensional drawing

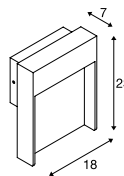

FLATT SENSOR  
WL



- The light colour can be selected during installation using a switch
- With integrated infrared movement sensor

Product details

100-277V ~50/60Hz | 500mA  
Total wattage: 16W  
Material: aluminium/aluminium



Dimensional drawing

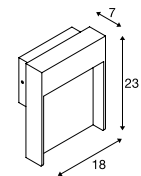

Tip

Sensor range adjustable from 6m to 9m, detection angle 120°

Variant	Item No.
460lm   3000/4000K   CRI80	
■ anthracite/anthracite	1002952
500lm   3000/4000K   CRI80	
■ anthracite/brown	1002953

Variant	Item No.
600lm   3000/4000K   CRI80	
■ anthracite/anthracite	1002954
600lm   3000/4000K   CRI80	
■ anthracite/brown	1002955

ORDI  
WL

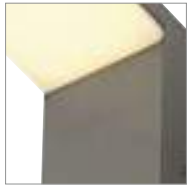

ORDI SENSOR  
WL



- With integrated infrared movement sensor

Product details

220-240V ~50/60Hz  
Total wattage: 9W  
Material: aluminium



Product details

220-240V ~50/60Hz  
Total wattage: 9W  
Material: aluminium



Dimensional drawing

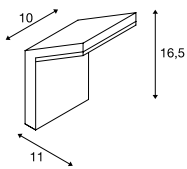

Dimensional drawing

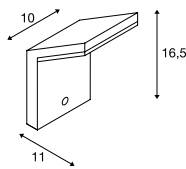

Tip

Sensor range adjustable up to 9m,  
detection angle 120°

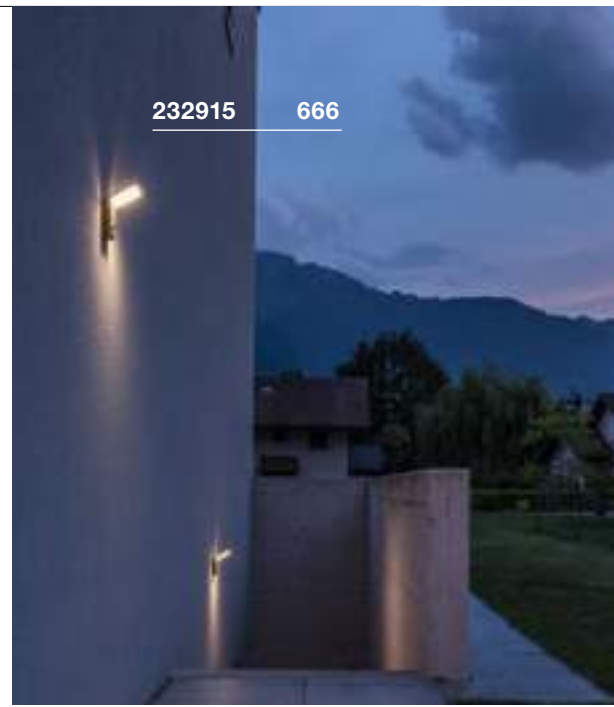

232915

666



231351

667

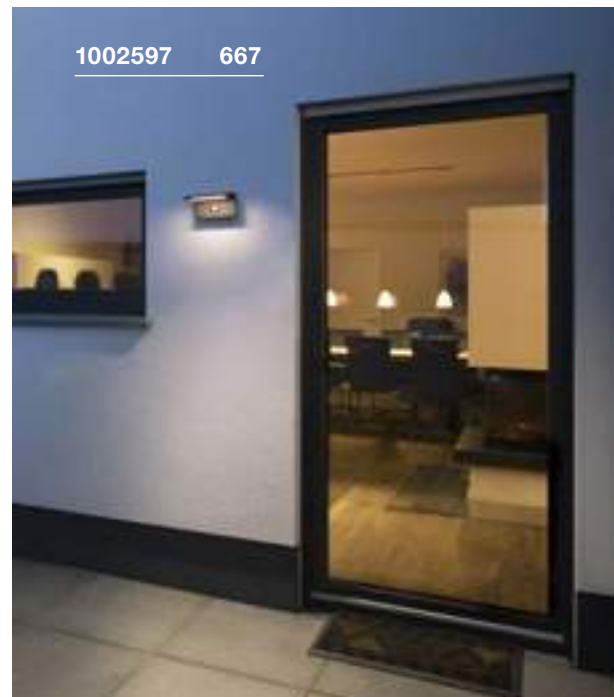

1002597

667

Variant	Item No.
500lm   3000K   CRI>80 ■ anthracite	232905

Variant	Item No.
500lm   3000K   CRI>80 ■ anthracite	232915

ANGOLUX  
WL



Product details

220-240V ~50/60Hz | 80mA  
Total wattage: 7.6W  
Material: aluminium/plastic



Dimensional drawing

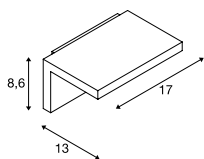

Tip

Protection rating IP44 only when mounted with light emission downwards.

Variant	Item No.
500lm   3000K   CRI>80	
white	231351
500lm   3000K   CRI>80	
anthracite	231355

ANGOLUX SENSOR  
WL



Product details

100-240V ~50/60Hz | 240mA  
Total output: 9.8W  
Material: aluminium/plastic

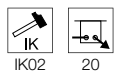

Dimensional drawing

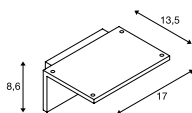

Tip

Detection angle 120°, max. detection distance 9m, sensitivity and operating time adjustable  
Protection rating IP44 only when mounted with light emission downwards.

Variant	Item No.
560lm   3000K   CRI>80	
white	1001970
560lm   3000K   CRI>80	
anthracite	1001969

ANGOLUX SOLAR  
WL



Product details

Battery operation  
Total output: 9.8W  
Material: aluminium



Dimensional drawing

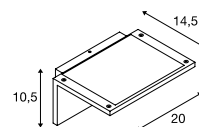

Tip

Movement sensor & solar panel inc. battery  
3.7V 2200mAh

Variant	Item No.
150lm   3000K   CRI>80	
anthracite	1002597

IPERI  
WL



LED  
INSIDE



231315

668

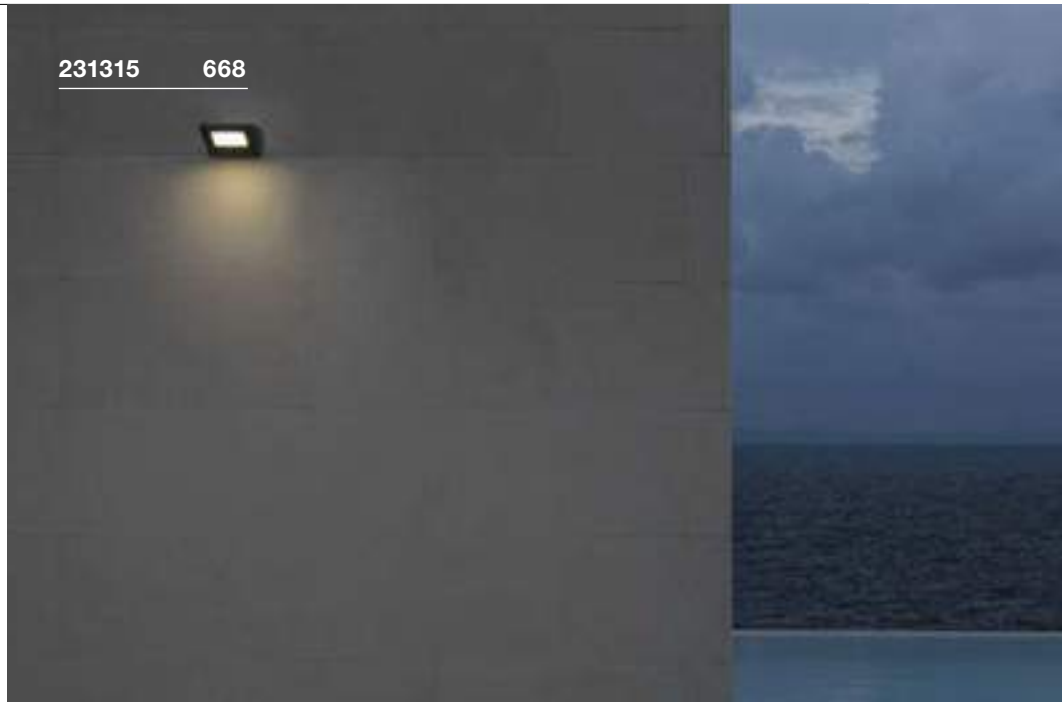

**Product details**

230V -50Hz  
Total wattage: 5W  
Material: aluminium/plastic

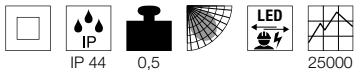

**Dimensional drawing**

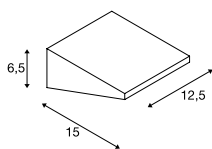

**Tip**

Protection rating IP44 only when mounted with light emission downwards.

230034

669



1002071

669



Variant	Item No.
320lm   4000K   CRI>70 ■ anthracite	231315

PEMA®  
WL, E27

SOCKET  
INSIDE



PEMA®  
WL

NEW  
VARIANT

LED  
INSIDE

CCT



PEMA®  
WL

LED  
INSIDE

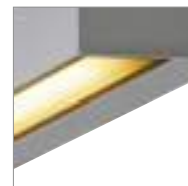
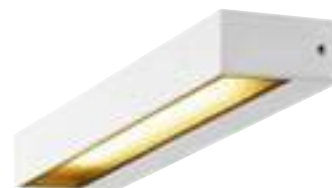

- The light colour can be selected during installation using a switch

Product details

230V -50Hz  
Material: aluminium/glass

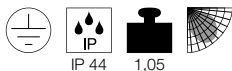

Dimensional drawing

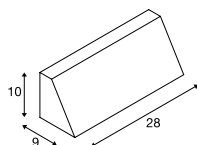

Tip

Protection rating IP44 only when mounted with light emission downwards.

Recommended lamp

LED E27 9W 240°  
3000K 810lm  
10kWh/1000h  
Item No. 1001031



LED E27 15W 240°  
3000K 1521lm  
15kWh/1000h  
Item No. 1001033



Lamp details

max. 15W  
Diameter: 4.5 cm max. L: 21 cm max.

Variant	Item No.
E27 ■ black	230030
E27 ■ grey	230034

Product details

100-277V ~50/60Hz | 350mA  
Total wattage: 16W  
Material: aluminium/glass



Dimensional drawing

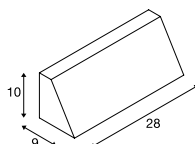

Product details

230V -50Hz  
Total wattage: 7.7W  
Material: aluminium/glass



Dimensional drawing

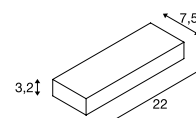

Tip

Protection rating IP54 only when mounted with light emission downwards.

Variant	Item No.
1260/1400lm   3000/4000K   CRI>80 ■ black	1003453
1260/1400lm   3000/4000K   CRI>80 ■ grey	1003454

Variant	Item No.
450lm   3000K   CRI>80 ■ anthracite	1002069
450lm   3000K   CRI>80 □ white	1002070
450lm   3000K   CRI>80 ■ grey	1002071

MALU  
WL



TRAPECCO DOWN  
WL



reddot award 2019  
winner



- Unusual design
- For even illumination
- Especially wide light distribution

Product details

220-240V ~50/60Hz  
Total wattage: 9.2W  
Material: aluminium/glass

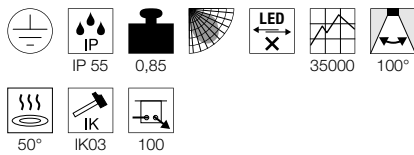

Product details

230V -50Hz  
Total wattage: 10W  
Material: aluminium



Dimensional drawing

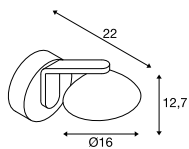

Dimensional drawing

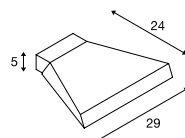

1002155 670



reddot award 2019  
winner

DESIGNED BY

Philippe Stephant

102155 670



Variant	Item No.
360lm   3000K   CRI>80 ■ anthracite	1002155

Variant	Item No.
850lm   3000K   CRI>80 ■ anthracite	231745 ▼



232285 671

QUADRASYL  
WL, TCR-TSE



SOCKET  
INSIDE



QUADRASYL  
CW, TCR-TSE



SOCKET  
INSIDE



• Shade: stainless steel 304

Product details

230V -50Hz  
Material: aluminium/glass

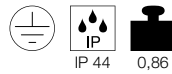

Product details

230V -50Hz  
Material: aluminium/stainless steel 304

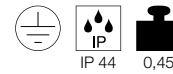

Dimensional drawing

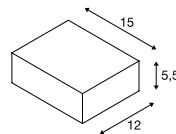

Dimensional drawing

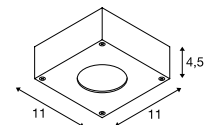

Tip

Fixture on the reverse



231745 670

Recommended lamp

LED GX53 3W 120°  
3000K 250lm  
3kWh/1000h  
Item No. 551372



Lamp details

max. 11W TCR-TSE  
Diameter: 7.5 cm max. L: 2.7 cm max.

Variant	Item No.
■ anthracite	232285

Recommended lamp

LED GX53 3W 120°  
3000K 250lm  
3kWh/1000h  
Item No. 551372



Lamp details

max. 9W TCR-TSE  
Diameter: 7.5 cm max. L: 2.7 cm max.

Variant	Item No.
■ grey	111482

QUAD  
WL



BIG QUAD  
WL

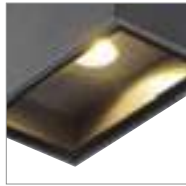
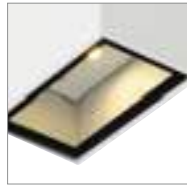

Product details

200-240V ~50/60Hz | 700mA  
Total wattage: 4.6W  
Material: aluminium/glass

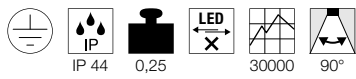

Product details

100-277V ~50/60Hz | 350mA  
Total wattage: 4.5W  
Material: aluminium/glass



Dimensional drawing

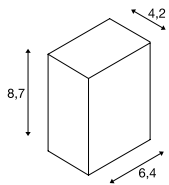

Dimensional drawing

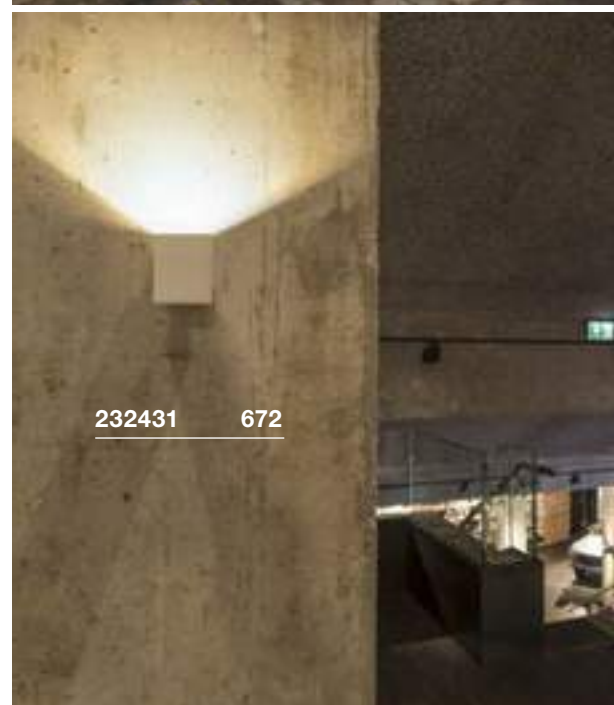
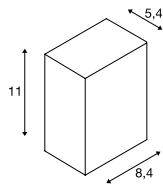

Variant	Item No.
100lm   3000K   CRI>80	
□ white	232461
80lm   3000K   CRI>80	
■ anthracite	232465

Variant	Item No.
290lm   3000K   CRI>80	
□ white	232431
260lm   3000K   CRI>80	
■ anthracite	232435





1002605 673

SAIL  
WL



LED  
INSIDE



**Product details**

200-240V ~50Hz  
Total wattage: 18W  
Material: aluminium

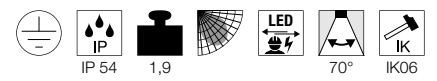

**Dimensional drawing**

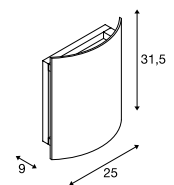

Variant	Item No.
400lm   3000K   CRI>80	
■ anthracite	1002605
590lm   3000K   CRI>80	
□ white	1002606

VILUA S  
WL

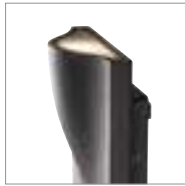

Product details

100-277V ~50/60Hz | 700mA  
Total wattage: 8.3W  
Material: aluminium/glass



Dimensional drawing

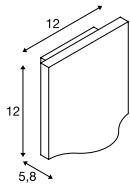

1002503 674



1002504 675

Variant	Item No.
405lm   3000K   CRI>80 ■ anthracite	1002503



1002505 675

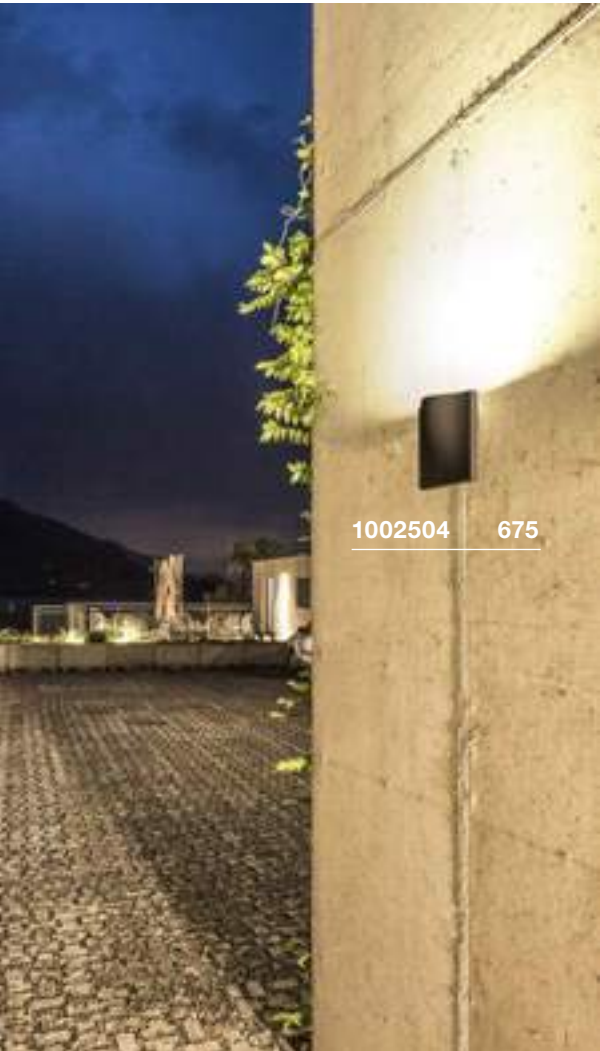

1002504 675

VILUA L  
WL



Product details

100-277V ~50/60Hz | 350mA  
Total wattage: 16W  
Material: aluminium/glass



Dimensional drawing

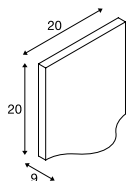

Variant	Item No.
810lm   3000K   CRI>80 ■ anthracite	1002504

VILUA  
UP/DOWN, WL

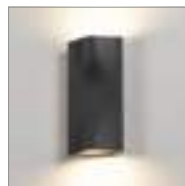

Product details

100-277V ~50/60Hz | 700mA  
Total wattage: 16W  
Material: aluminium/glass



Dimensional drawing

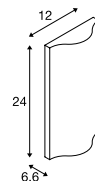

Variant	Item No.
Up: 392lm   3000K   CRI>80 Down: 392lm   3000K   CRI>80 ■ anthracite	1002505

THEO  
WL, QPAR51



SOCKET  
INSIDE



Product details

230V -50Hz  
Material: aluminium/glass



Dimensional drawing

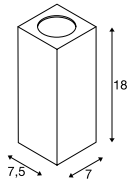

Recommended lamp

LED GU10 4W 36°  
3000K 300lm  
4kWh/1000h  
Item No. 1004973



LED GU10 6W 36°  
2700K 460lm  
6kWh/1000h  
Item No. 1005077



Lamp details

max. 35W QPAR51

Variant	Item No.
GU10   QPAR51	
□ white	229521
GU10   QPAR51	
■ grey	229524
GU10   QPAR51	
■ anthracite	229525

BIG THEO  
WL, QPAR111



SOCKET  
INSIDE



Product details

230V -50Hz  
Material: aluminium/glass

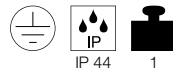

Dimensional drawing

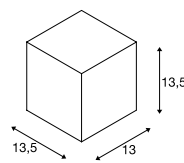

Recommended lamp

GU10 7W 13°  
3000K 660lm  
8kWh/1000h  
Item No. 1001568



LED GU10 13W 140°  
2700K 1000lm  
13kWh/1000h  
Item No. 1001244



Lamp details

max. 75W QPAR111

Variant	Item No.
GU10   QPAR111	
□ white	229561
GU10   QPAR111	
■ grey	229564
GU10   QPAR111	
■ anthracite	229565

229525

676



229561

676





234525 677



234525 677

BIG THEO  
WL



Product details

100-277V ~50/60Hz | 500mA  
Total wattage: 21W  
Material: aluminium/glass



IP 44

1,3

30000

24°



IK02

Dimensional drawing

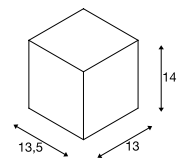

Variant

Item No.

2000lm | 3000K | CRI>80  
■ anthracite

234525

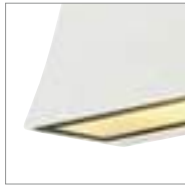
DELWA  
WLLED  
INSIDE

## Product details

100-240V ~50/60Hz | 700mA  
Total wattage: 10W  
Material: aluminium/glass



## Dimensional drawing

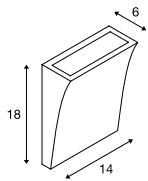

1000340 678

Variant	Item No.
910lm   3000K   CRI>80 white	1000340
910lm   3000K   CRI>80 anthracite	1000342



233114 679

MYRA UP/DOWN  
WL, QPAR51
**SOCKET**  
**INSIDE**

**Product details**

 220-240V ~50/60Hz  
 Material: aluminium/glass

IP 55

0,58

IK02

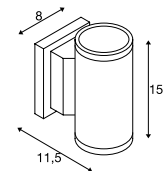
**Dimensional drawing**

**Recommended accessories**

■ Surface mounting frames

Item No. 233214



■ Surface mounting frames

Item No. 233215

**Recommended lamp**

LED GU10 4W 36°

3000K 300lm

4kWh/1000h

Item No. 1004973



LED GU10 4W 36°

4000K 300lm

4kWh/1000h

Item No. 1004974

**Lamp details**

2x max. 35W QPAR51

Diameter: 5cm max. L: 5.7cm max.

Variant	Item No.
GU10   QPAR51	
■ grey	233114
GU10   QPAR51	
■ anthracite	233115

SITRA UP/DOWN  
WL, TCR-TSE



SITRA UP/DOWN  
WL



ASTINA  
WL, QPAR51



SOCKET  
INSIDE



LED  
INSIDE



SOCKET  
INSIDE



Product details

230V -50Hz  
Material: aluminium/glass

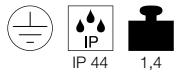

Product details

220-240V ~50/60Hz  
Total wattage: 17W  
Material: aluminium/glass



Product details

230V -50Hz  
Material: aluminium/glass

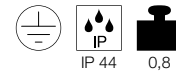

Dimensional drawing

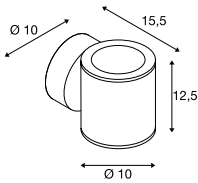

Dimensional drawing

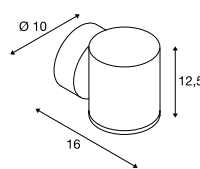

Dimensional drawing

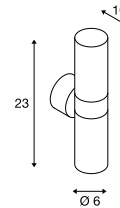

Recommended lamp

LED GX53 4.2W 35°  
3000K 200lm  
5kWh/1000h  
Item No. 550092



LED GX53 3W 120°  
3000K 250lm  
3kWh/1000h  
Item No. 551372



Lamp details

2x max. 9W TCR-TSE  
Diameter: 7.5 cm max. L: 3.5 cm max.

Recommended lamp

LED GU10 4W 36°  
3000K 300lm  
4kWh/1000h  
Item No. 1004973



LED GU10 4W 36°  
4000K 300lm  
4kWh/1000h  
Item No. 1004974



Lamp details

2x max. 11W LED GU10  
L: 9cm max.

Variant	Item No.
GX53   TCR-TSE	
■ anthracite	230365

Variant	Item No.
Up: 488lm   3000K   CRI>80 Down: 488lm   3000K   CRI>80	
■ anthracite	1002018
Up: 488lm   3000K   CRI>80 Down: 488lm   3000K   CRI>80	
□ white	1002041

Variant	Item No.
GU10   TCR50-SE	
□ white	228771
GU10   TCR50-SE	
■ anthracite	228775
GU10   TCR50-SE	
□ aluminium	228776





228775 680



233302 681

**ASTINA STEEL**  
WL, QPAR51



**SOCKET**  
**INSIDE**



- Lights made from stainless steel 304

**Product details**

230V -50Hz  
Material: stainless steel 304

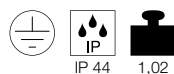

IP 44 1,02

**Dimensional drawing**

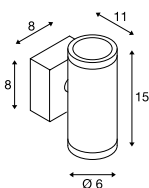

**Recommended lamp**

LED GU10 4W 36°  
3000K 300lm  
4kWh/1000h  
**Item No. 1004973**



LED GU10 4W 36°  
4000K 300lm  
4kWh/1000h  
**Item No. 1004974**



**Lamp details**

2x max. 35W QPAR51  
Diameter: 5.1cm max. L: 5.7cm max.

Variant	Item No.
GU10   QPAR51 ■ stainless steel	<b>233302</b>

**ASTINA STEEL**  
WL



**LED**  
**INSIDE**

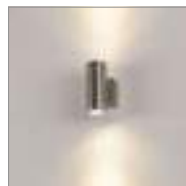

- Lights made from high-quality 316 stainless steel

**Product details**

100-277V ~50/60Hz | 350mA  
Total wattage: 8.7W  
Material: stainless steel 316



IP 44 1,38 25000 24°



**Dimensional drawing**

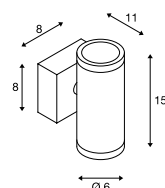

Variant	Item No.
510lm   3000K   CRI>80 ■ stainless steel	<b>233312</b>

## RUSTY® UP/DOWN WL, round



NEW

LED  
INSIDE

CCT



- The light colour can be selected during installation using a switch

### Product details

220-240V ~50/60Hz | 350mA

Total wattage: 14W

Material: FeCSi stainless steel/aluminium



IP 65



3,55



65°



65°



IK02

### Dimensional drawing

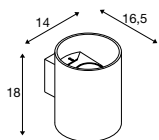

1004651 682



Variant	Item No.
Up: 249/254lm   3000/4000K   CRI>80	
Down: 267/271lm   3000/4000K   CRI>80	
rust	1004651



1000334 683



1000334 683

ROX UP/DOWN  
WL, QPAR111



SOCKET  
INSIDE



- High-quality brushed surface

Product details

230V -50Hz  
Material: aluminium/glass

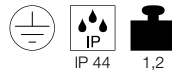

POLE PARC UP/DOWN  
WL



LED  
INSIDE

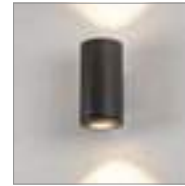

- Perfectly suitable for the effective accentuation of building architecture

Product details

100-240V ~50/60Hz | 700mA  
Total wattage: 56W  
Material: aluminium/glass

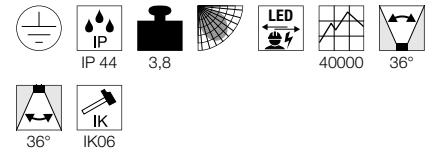

Dimensional drawing

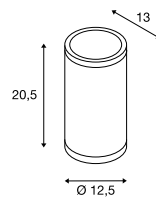

Dimensional drawing

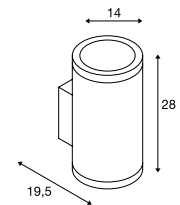

Recommended lamp

LED GU10 13W 30°  
2700K 1100lm  
13kWh/1000h  
Item No. 1001242



LED GU10 13W 30°  
4000K 1100lm  
13kWh/1000h  
Item No. 1003087



Lamp details

2x max. 50W QPAR111

Variant	Item No.
GU10   QPAR111 aluminium	1000334

Variant	Item No.
Up: 2900lm   3000K   CRI>80 Down: 2900lm   3000K   CRI>80 anthracite	1000446

ENOLA ROUND S  
WL, single



NEW

LED  
INSIDE

CCT



- The light colour can be selected during installation using a switch

Product details

100-240V ~50/60Hz | 500mA  
Total wattage: 6W  
Material: aluminium/glass

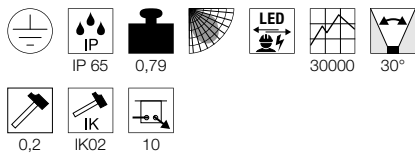

Dimensional drawing

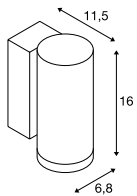

ENOLA ROUND M  
WL, single



NEW

LED  
INSIDE

CCT



- The light colour can be selected during installation using a switch

Product details

100-240V ~50/60Hz | 500mA  
Total wattage: 10W  
Material: aluminium/glass

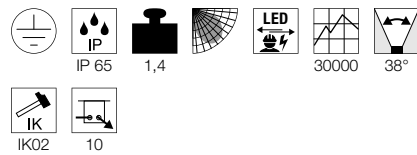

Dimensional drawing

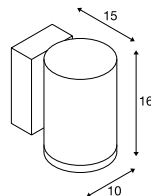

ENOLA ROUND L  
WL, single



NEW

LED  
INSIDE

CCT



- The light colour can be selected during installation using a switch

Product details

220-240V ~50/60Hz | 900mA  
Total wattage: 35W  
Material: aluminium/glass

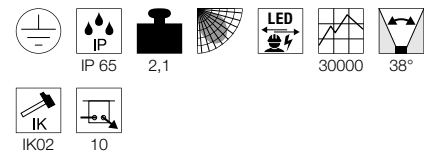

Dimensional drawing

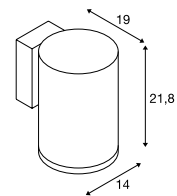

Variant	Item No.
390/450lm   3000/4000K   CRI>90	
■ anthracite	1003422

Variant	Item No.
720/820lm   3000/4000K   CRI>90	
■ anthracite	1003423

Variant	Item No.
3100/3400lm   3000/4000K   CRI>90	
■ anthracite	1003440

ENOLA L ROUND  
UP/DOWN S  
WL



• The light colour can be selected during installation using a switch

Product details

220-240V ~50/60Hz | 350mA  
Total wattage: 7W  
Material: aluminium/glass

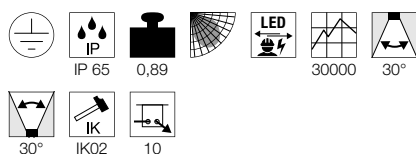

Dimensional drawing

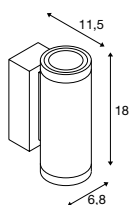

Variant	Item No.
Up: 285/320lm   3000/4000K   CRI>90 Down: 285/320lm   3000/4000K   CRI>90 ■ anthracite	1003424

ENOLA L ROUND  
UP/DOWN M  
WL



• The light colour can be selected during installation using a switch

Product details

120-277V ~50/60Hz | 500mA  
Total wattage: 19W  
Material: aluminium/glass

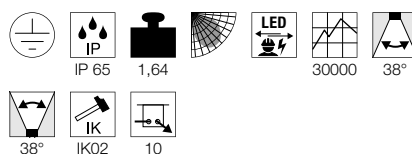

Dimensional drawing

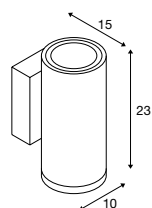

Variant	Item No.
Up: 740/840lm   3000/4000K   CRI>90 Down: 740/840lm   3000/4000K   CRI>90 ■ anthracite	1003425

ENOLA L ROUND  
UP/DOWN L  
WL



• The light colour can be selected during installation using a switch

Product details

220-240V ~50/60Hz | 700mA  
Total wattage: 53W  
Material: aluminium/glass

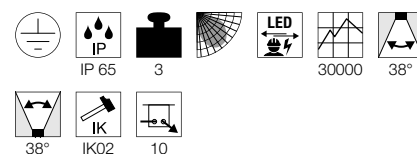

Dimensional drawing

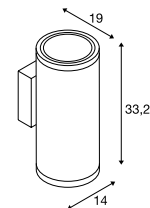

Variant	Item No.
Up: 2700/3000lm   3000/4000K   CRI>90 Down: 2700/3000lm   3000/4000K   CRI>90 ■ anthracite	1003441

SQUARE TURN  
WL, G9



SOCKET  
INSIDE

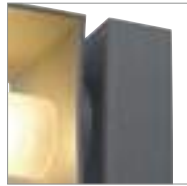
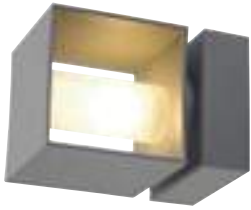

- Front part can be rotated 360°

Product details

230V -50Hz  
Material: aluminium/glass



Dimensional drawing

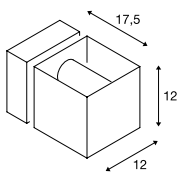

Recommended lamp

LED G9 2.7W  
2600K 250lm  
3kWh/1000h  
Item No. 1003102



LED G9 2.5W  
2700K 180lm  
3kWh/1000h  
Item No. 560302



Lamp details

max. 42W QT14  
Diameter: 3.5 cm max. L: 8 cm max.

Variant	Item No.
G9   QT14	
■ grey	1000335

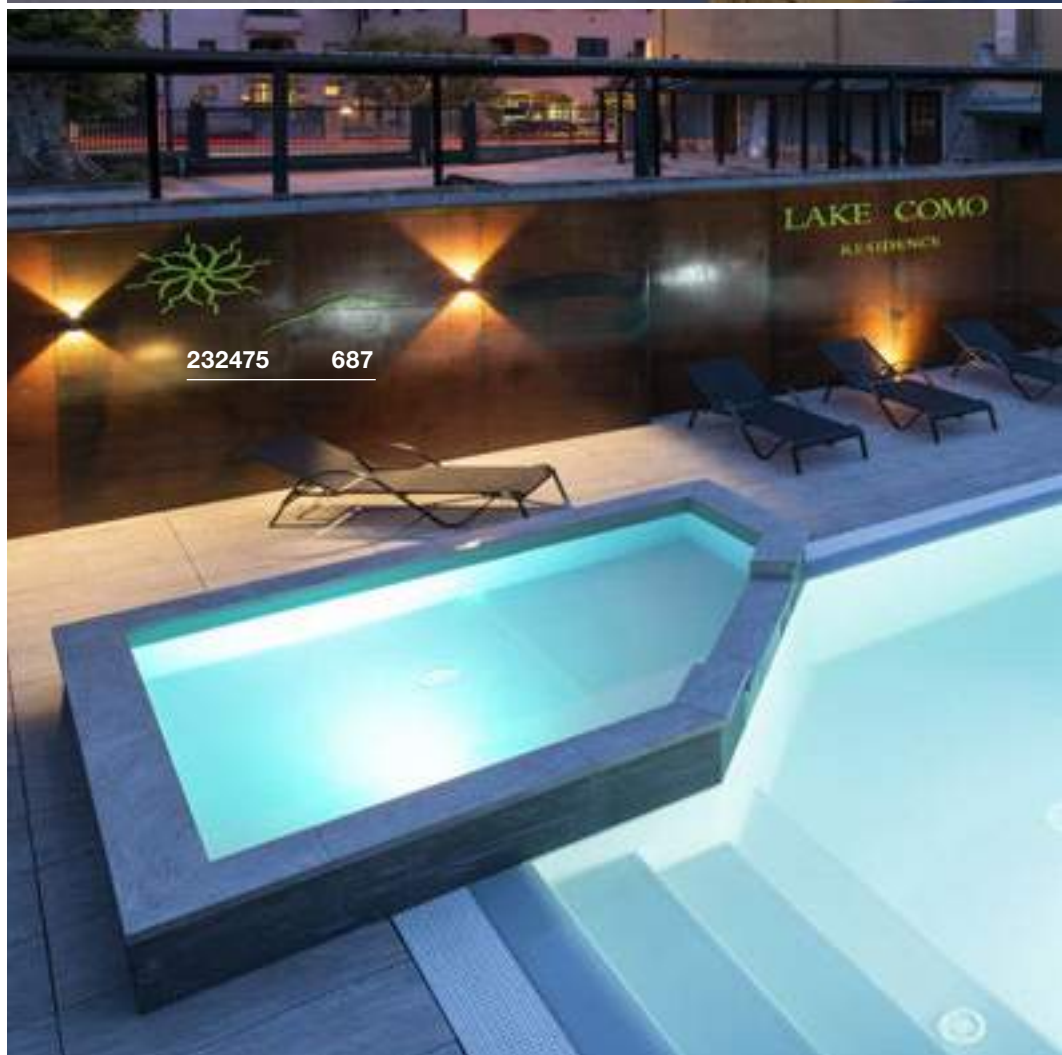
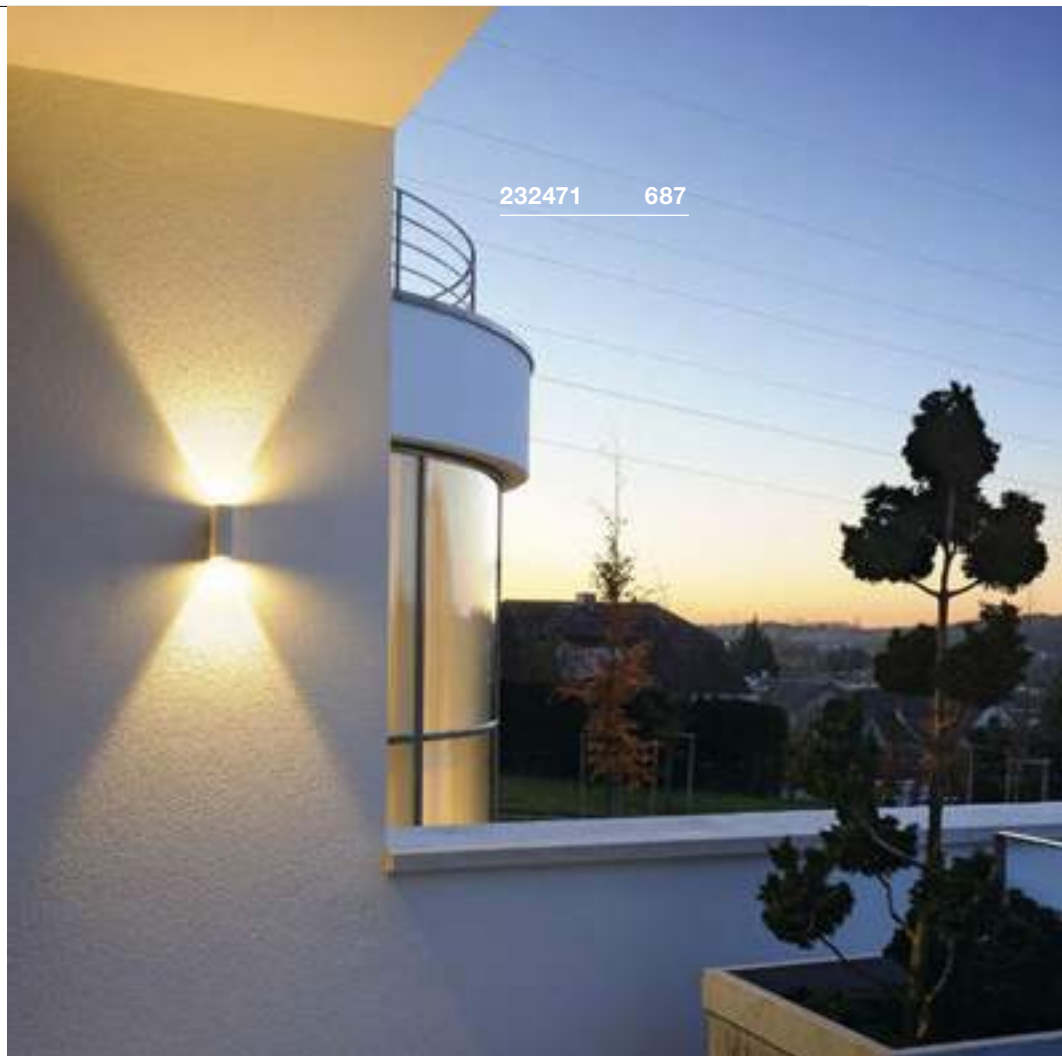

QUAD UP/DOWN 12  
WL



Product details

200-240V ~50/60Hz | 700mA  
Total wattage: 6.8W  
Material: aluminium/glass

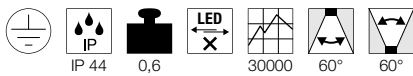

Dimensional drawing

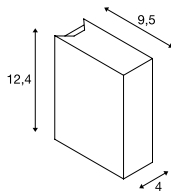

Tip

Mounting surface located on the narrow side of the housing

QUAD UP/DOWN 15  
WL



Product details

100-277V ~50/60Hz | 350mA  
Total wattage: 8.6W  
Material: aluminium/glass



Dimensional drawing

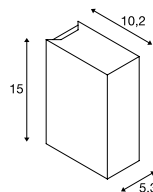

Tip

Mounting surface located on the narrow side of the housing

BIG QUAD UP/DOWN  
WL



Product details

200-240V ~50/60Hz | 350mA  
Total wattage: 8.8W  
Material: aluminium/glass

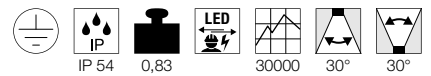

Dimensional drawing

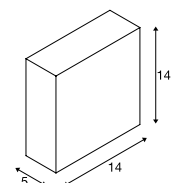

Variant	Item No.
175lm   3000K   CRI>80	
□ white	232471
140lm   3000K   CRI>80	
■ anthracite	232475

Variant	Item No.
290lm   3000K   CRI>80	
□ white	232441
260lm   3000K   CRI>80	
■ anthracite	232445

Variant	Item No.
240lm   3000K   CRI>80	
□ white	232451
240lm   3000K   CRI>80	
■ anthracite	232455

L-LINE OUT 15  
WL, vertical



MANA OUT  
WL, PHASE



- The light colour can be selected during installation using a switch

- Narrower light beam possible thanks to the included accessories

Product details

220-240V ~50/60Hz | 350mA  
Total wattage: 7W  
Material: aluminium/polycarbonate (PC)



Product details

220-240V ~50/60Hz  
Total wattage: 12W  
Material: aluminium/steel  
Dimmable: C, L

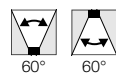

Dimensional drawing

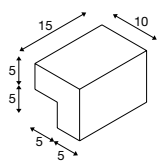

Dimensional drawing

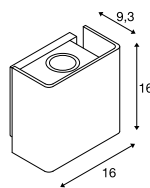

1003539 688

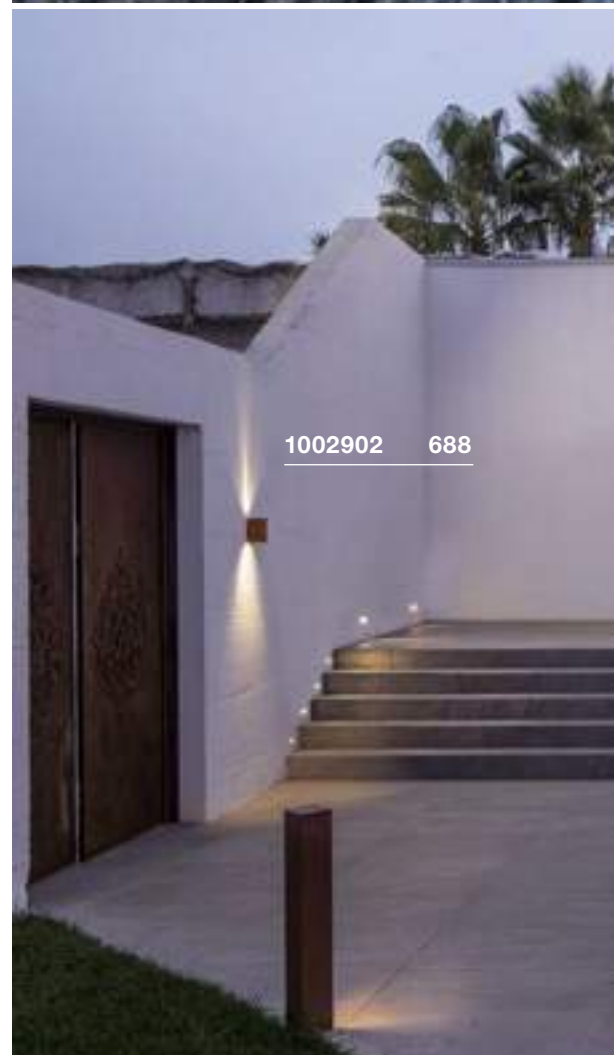

1002902 688

Variant	Item No.
500/570lm   3000/4000K   CRI>80 ■ anthracite	1003539

Variant	Item No.
650lm   3000K   CRI>80 ■ anthracite	1002900
650lm   3000K   CRI>80 ■ rust	1002902





1002035 689



232495 689

**BOX-L  
WL, E27**

SOCKET  
INSIDE

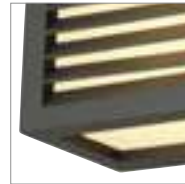

**BOX-L  
WL**

LED  
INSIDE



- Light offering direct/indirect light distribution with additional light emission to the front
- Accentuated wall lighting and even ground illumination in one

**Product details**

220-240V ~50/60Hz  
Material: aluminium/acrylic

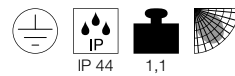

**Product details**

220-240V ~50/60Hz  
Total wattage: 19W  
Material: aluminium/acrylic



**Dimensional drawing**

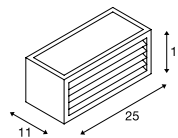

**Dimensional drawing**

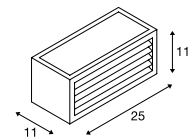

**Recommended lamp**

LED E27 9,1W 240°  
2700K 760lm  
10kWh/1000h  
Item No. 560402



LED E27 9W 240°  
3000K 810lm  
10kWh/1000h  
Item No. 1001031



**Lamp details**

max. 18W  
Diameter: 6 cm max. L: 17.5 cm max.

Variant	Item No.
E27 □ white	232491
E27 ■ anthracite	232495
E27 ■ brown	232497

Variant	Item No.
480lm   3000K   CRI>80 □ white	1002037
480lm   3000K   CRI>80 ■ anthracite	1002035
480lm   3000K   CRI>80 ■ brown	1002036

**BOX UP/DOWN**  
WL, QT-DE12

SECKET  
INSIDE



**RUSTY® UP/DOWN**  
WL, square



NEW

SECKET  
INSIDE

CCT



**Product details**

220-240V ~50/60Hz  
Material: aluminium/glass

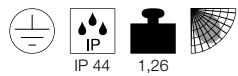

**Product details**

220-240V ~50/60Hz | 350mA  
Total wattage: 14W  
Material: FeCSi stainless steel/aluminium



**Dimensional drawing**

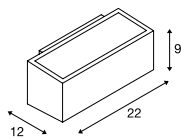

**Dimensional drawing**

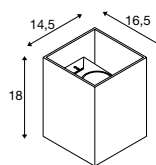

**Recommended lamp**

R7s 78mm 55W 330°  
3000K 530lm  
6kWh/1000h  
Item No. 560332



**Lamp details**

max. 80W QT-DE12

Variant	Item No.
R7s 78mm   QT-DE12	
white	232481
R7s 78mm   QT-DE12	
anthracite	232485

Variant	Item No.
Up: 259/260lm   3000/4000K   CRI>80	
Down: 285/288lm   3000/4000K   CRI>80	
rust	1004650

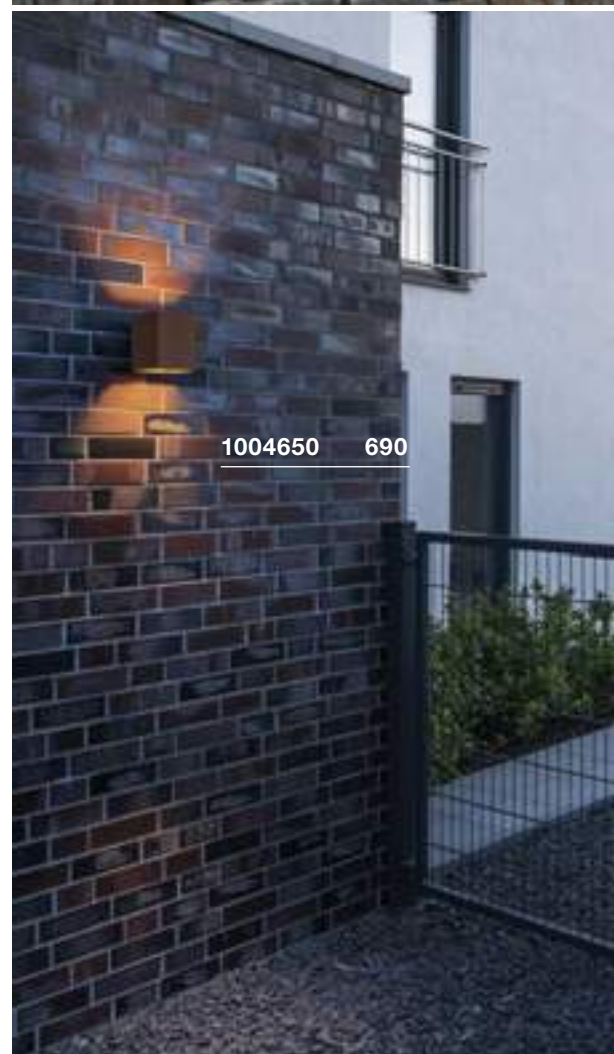



1002033 691



1002034 691



1002032 691

SITRA CUBE  
WL, TCR-TSE



SOCKET  
INSIDE



SITRA CUBE  
WL



LED  
INSIDE



Product details

220-240V ~50/60Hz  
Material: aluminium/glass

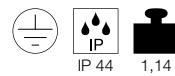

Dimensional drawing

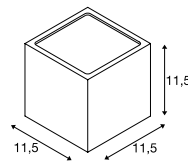

Product details

100-277V ~50/60Hz | 500mA  
Total wattage: 10W  
Material: aluminium/glass

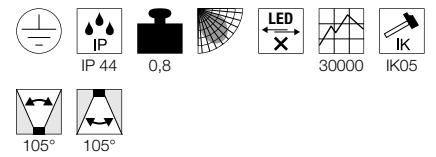

Dimensional drawing

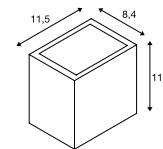

Recommended lamp

LED GX53 3W 120°  
3000K 250lm  
3kWh/1000h  
Item No. 551372



Lamp details

2x max. 9W TCR-TSE  
Diameter: 7.5 cm max. L: 2.7 cm max.

Variant	Item No.
GX53   TCR-TSE	
□ white	232531
GX53   TCR-TSE	
■ anthracite	232535
GX53   TCR-TSE	
■ brown	232537

Variant	Item No.
Up: 560lm   3000K   CRI>80 Down: 560lm   3000K   CRI>80	
■ anthracite	1002032
Up: 560lm   3000K   CRI>80 Down: 560lm   3000K   CRI>80	
□ white	1002033
Up: 560lm   3000K   CRI>80 Down: 560lm   3000K   CRI>80	
■ brown	1002034

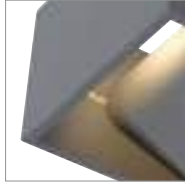
LOGS  
WLLED  
INSIDE

232101 692

**Product details**

100-240V ~50/60Hz | 500mA  
 Total wattage: 8W  
 Material: aluminium

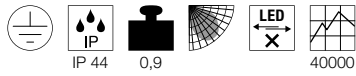
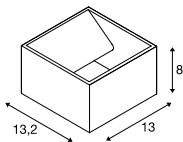
**Dimensional drawing**

Variant	Item No.
650lm   3000K   CRI>80 □ white	232101
550lm   3000K   CRI>80 ■ grey	232104
420lm   3000K   CRI>80 ■ anthracite	232105





229535 693



229532 693

THEO UP/DOWN  
WL, QPAR51



SOCKET  
INSIDE



Product details

220-240V ~50/60Hz  
Material: aluminium/glass

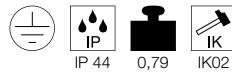

Dimensional drawing

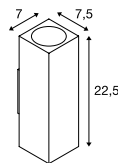

Recommended lamp

LED GU10 4W 36°  
2700K 300lm  
4kWh/1000h  
Item No. 1004972



LED GU10 5.5W 38°  
2700K 400lm  
6kWh/1000h  
Item No. 1001030



Lamp details

2x max. 35W QPAR51

Variant	Item No.
GU10   QPAR51	
□ white	229531
GU10   QPAR51	
■ grey	229532
GU10   QPAR51	
■ anthracite	229535
GU10   QPAR51	
□ aluminium	1000331

BIG THEO UP/DOWN  
WL, QPAR111



SOCKET  
INSIDE



Product details

230V -50Hz  
Material: aluminium/glass

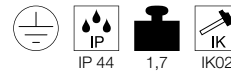

Dimensional drawing

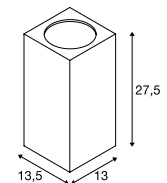

Recommended lamp

LED GU10 13W 30°  
2700K 1100lm  
13kWh/1000h  
Item No. 1001242



LED GU10 13W 140°  
2700K 1000lm  
13kWh/1000h  
Item No. 1001244



Lamp details

2x max. 75W QPAR111

Variant	Item No.
GU10   QPAR111	
□ white	229571
GU10   QPAR111	
■ grey	229574
GU10   QPAR111	
■ anthracite	229575

BIG THEO  
FLOOD UP/DOWN  
WLLED  
INSIDE

## Product details

100-240V ~50/60Hz | 1000mA  
Total wattage: 42W  
Material: aluminium/glass

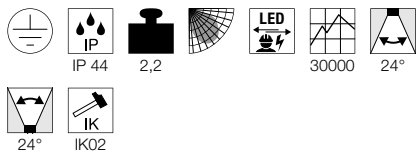

## Dimensional drawing

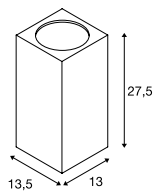

234505 694

Variant	Item No.
Up: 2000lm   3000K   CRI>80 Down: 2000lm   3000K   CRI>80	234505
■ anthracite	





234515 695

## BIG THEO BEAM UP/FLOOD DOWN WL



LED  
INSIDE



### Product details

120-240V ~50/60Hz | 500mA  
Total wattage: 29W  
Material: aluminium/glass



IP 44

2,3

25000

24°



2°

IK02

### Dimensional drawing

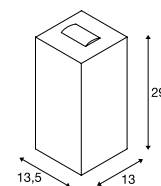

### Variant

### Item No.

Flood: 2000lm | 3000K | CRI>80  
Beam: 130lm | 3000K | CRI>80

■ anthracite

234515

ENOLA SQUARE S  
WL, single



NEW

LED  
INSIDE

CCT



- The light colour can be selected during installation using a switch

Product details

100-240V ~50/60Hz | 500mA  
Total wattage: 6W  
Material: aluminium/glass

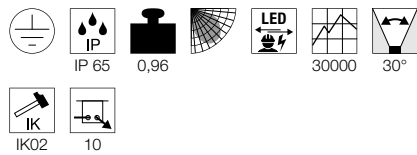

Dimensional drawing

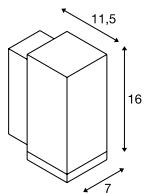

Recommended accessories

Spacer set for outdoors  
Item No. 1002853



Variant	Item No.
390/450lm   3000/4000K   CRI>90 ■ anthracite	1003416

ENOLA SQUARE M  
WL, single



NEW

LED  
INSIDE

CCT



- The light colour can be selected during installation using a switch

Product details

100-240V ~50/60Hz | 500mA  
Total wattage: 10W  
Material: aluminium/glass

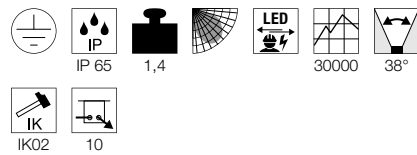

Dimensional drawing

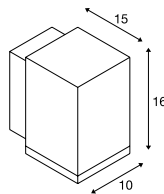

Recommended accessories

Spacer set for outdoors  
Item No. 1002853



Variant	Item No.
720/820lm   3000/4000K   CRI>90 ■ anthracite	1003417

ENOLA SQUARE L  
WL, single



NEW

LED  
INSIDE

CCT



- The light colour can be selected during installation using a switch

Product details

220-240V ~50/60Hz | 900mA  
Total wattage: 35W  
Material: aluminium/glass

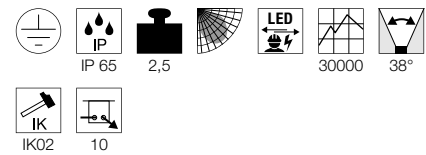

Dimensional drawing

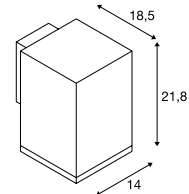

Recommended accessories

Spacer set for outdoors  
Item No. 1002853



Variant	Item No.
3100/3400lm   3000/4000K   CRI>90 ■ anthracite	1003437



ENOLA SQUARE S  
UP/DOWN  
WL



- The light colour can be selected during installation using a switch

Product details

220-240V ~50/60Hz | 350mA  
Total wattage: 7W  
Material: aluminium/glass

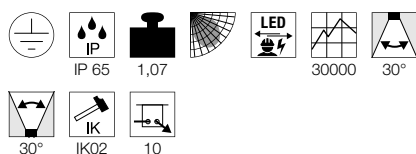

Dimensional drawing

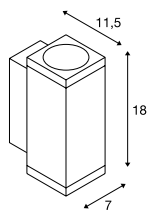

Recommended accessories

Spacer set for outdoors  
Item No. 1002853



Variant	Item No.
Up: 285/320lm   3000/4000K   CRI>90 Down: 285/320lm   3000/4000K   CRI>90 ■ matt anthracite	1003418

ENOLA SQUARE M  
UP/DOWN  
WL



- The light colour can be selected during installation using a switch

Product details

120-277V ~50/60Hz | 500mA  
Total wattage: 19W  
Material: aluminium/glass

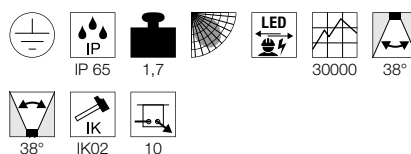

Dimensional drawing

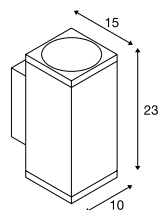

Recommended accessories

Spacer set for outdoors  
Item No. 1002853



Variant	Item No.
Up: 740/840lm   3000/4000K   CRI>90 Down: 740/840lm   3000/4000K   CRI>90 ■ matt anthracite	1003419

ENOLA SQUARE L  
UP/DOWN  
WL



- The light colour can be selected during installation using a switch

Product details

220-240V ~50/60Hz | 700mA  
Total wattage: 53W  
Material: aluminium/glass

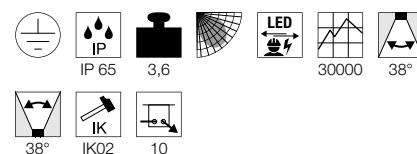

Dimensional drawing

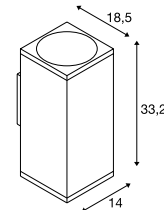

Recommended accessories

Spacer set for outdoors  
Item No. 1002853



Variant	Item No.
Up: 2700/3000lm   3000/4000K   CRI>90 Down: 2700/3000lm   3000/4000K   CRI>90 ■ matt anthracite	1003438

OUT-BEAM UP/DOWN  
WL, QT-DE12

SOCKET  
INSIDE



Product details

230V ~50/60Hz  
Material: aluminium/glass



Dimensional drawing

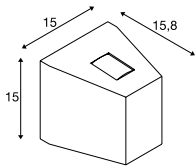

Lamp details

80W QT-DE12  
L: 7.8 cm max.

Variant	Item No.
R7s 78mm   QT-DE12	
■ grey	1000587
R7s 78mm   QT-DE12	
■ anthracite	1000588

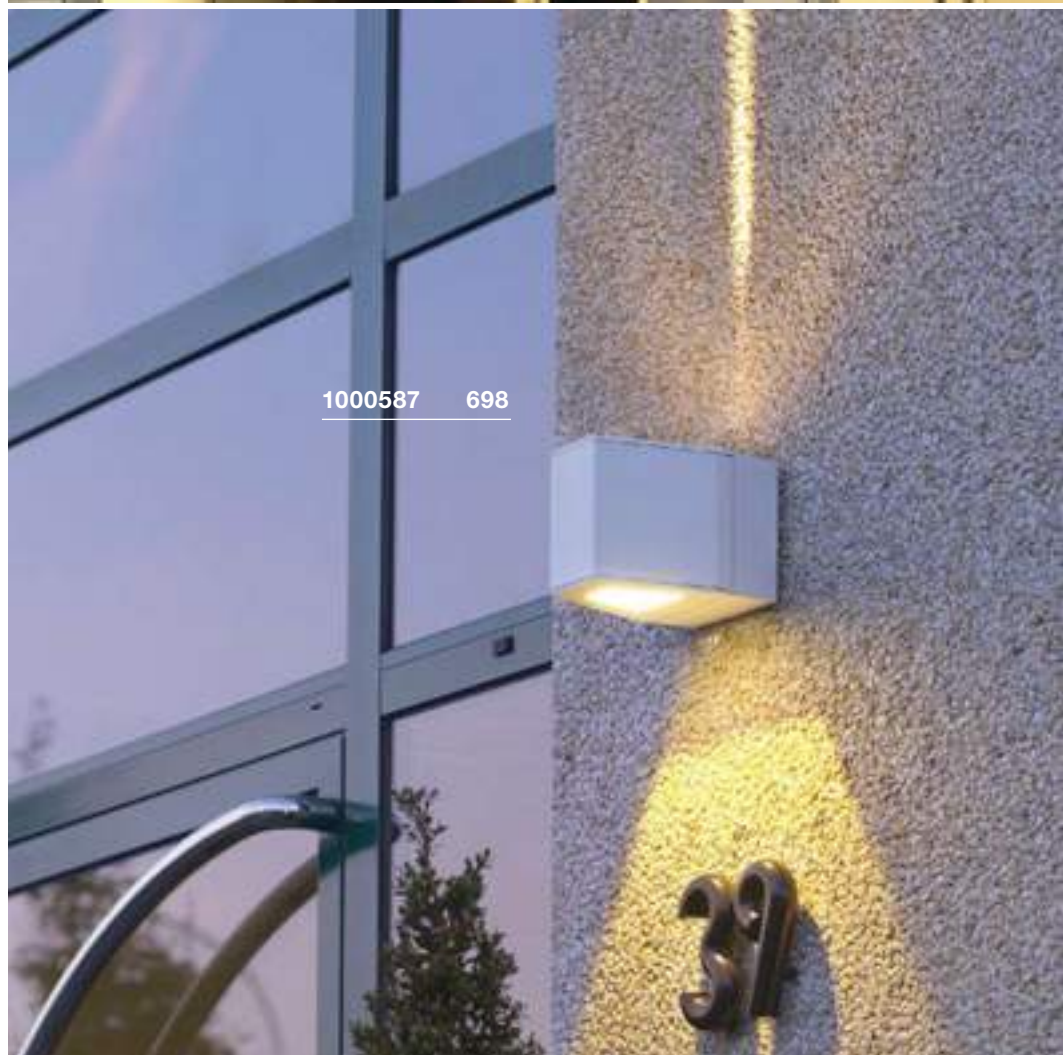



229664 699

OUT-BEAM UP/FLOOD DOWN  
WL



Product details

120-277V ~50/60Hz | 500mA  
Total wattage: 18W  
Material: aluminium/glass

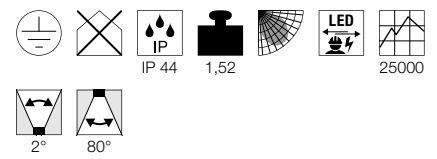

Dimensional drawing

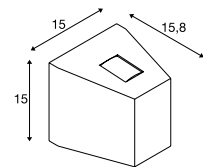

Variant	Item No.
Flood: 690lm   3000K   CRI>80 Beam: 50lm   3000K   CRI>80	
■ grey	229664
Flood: 690lm   3000K   CRI>80 Beam: 50lm   3000K   CRI>80	
■ anthracite	229665

ESKINA D  
Display, PHASE



TODAY PRO  
Display

TODAY  
Display



- The light colour can be selected during installation using a switch

Product details

220-240V ~50/60Hz | 350mA  
Total wattage: 14.5W  
Material: aluminium  
Dimmable: C

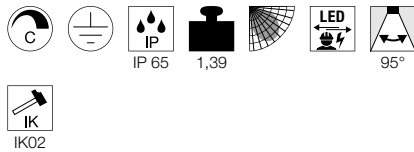

Product details

220-240V ~50/60Hz | 640mA  
Total wattage: 29W  
Material: aluminium

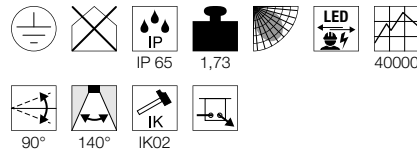

Product details

220-240V ~50/60Hz | 640mA  
Total wattage: 29W  
Material: aluminium

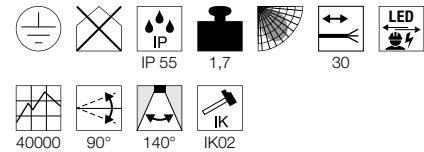

Dimensional drawing

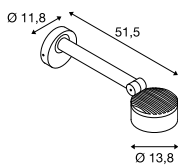

Dimensional drawing

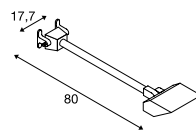

Dimensional drawing

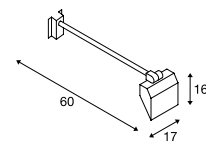

Tip

Open cable end

Variant	Item No.
1000lm   3000/4000K   CRI>80 ■ matt anthracite	1002905

Variant	Item No.
2800lm   4000K   CRI>70 ■ black	1000880
2800lm   4000K   CRI>70 □ white	1000881

Variant	Item No.
2800lm   4000K   CRI>70 ■ black	227700
2800lm   4000K   CRI>70 □ white	227701



1002905 700

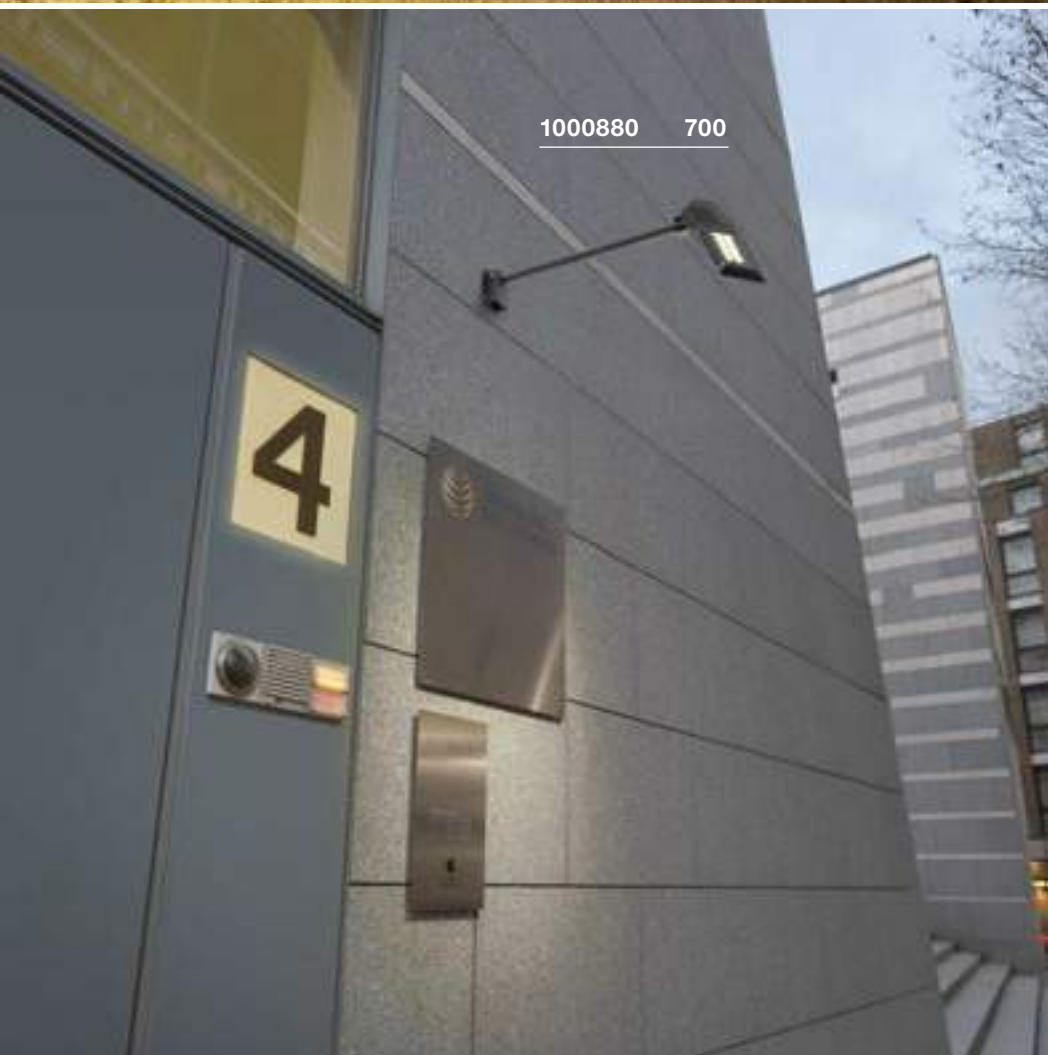

1000880 700

MYRA DISPLAY  
WL, curved, QPAR51



SOCKET  
INSIDE



Product details

220-240V ~50/60Hz  
Material: aluminium



IP 55

0,73

340°

Dimensional drawing

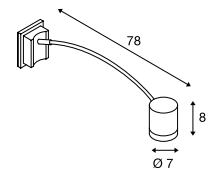

Recommended accessories

■ Surface mounting frames

Item No. 233214

■ Surface mounting frames

Item No. 233215



Recommended lamp

LED GU10 4W 36°  
3000K 300lm  
4kWh/1000h  
Item No. 1004973



LED GU10 6W 36°  
3000K 460lm  
6kWh/1000h  
Item No. 1005078



Lamp details

max. 50W QPAR51  
Diameter: 5cm max. L: 5.7cm max.

Variant	Item No.
GU10   QPAR51	
■ grey	233134
GU10   QPAR51	
■ anthracite	233135

**PHOTONIA**  
CL, E27



**MOLAT**  
CL, E27



SOCKET  
INSIDE



SOCKET  
INSIDE



**Product details**

220-240V ~50/60Hz  
Material: aluminium/glass



**Product details**

230V ~50/60Hz  
Material: aluminium/glass



**Dimensional drawing**

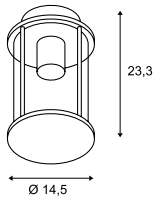

**Dimensional drawing**

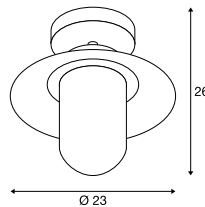

**Recommended lamp**

LED E27 7.1W 330°  
2700K 806lm  
8kWh/1000h  
Item No. 1001756



LED E27 5W 330°  
2000K 500lm  
5kWh/1000h  
Item No. 560741



**Recommended lamp**

LED E27 7W 280°  
2200-2700K 830lm  
7kWh/1000h  
Item No. 1002126



LED E27 7W 280°  
2700K 790lm  
7kWh/1000h  
Item No. 1002124



**Lamp details**

max. 60W  
Diameter: 9 cm max. L: 15 cm max.

**Lamp details**

max. 60W  
Diameter: 6.5 cm max. L: 14.5 cm max.

Variant	Item No.
E27	
■ anthracite	232055

Variant	Item No.
E27	
■ anthracite	1000823



232055 702



1000823 702



1004677 703

OVALISK  
CL

NEW

LED  
INSIDE

CCT



- The light colour can be selected during installation using a switch

## Product details

100-240V ~50/60Hz | 350mA  
Total wattage: 7.5W  
Material: aluminium/glass



IP 65



1,7



IK02

## Dimensional drawing

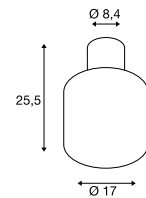

Variant	Item No.
500/540lm   3000/4000K   CRI>80 ■ anthracite	1004677

SITRA  
CL, TCR-TSESOCKET  
INSIDE

## Product details

230V -50Hz  
Material: aluminium/glass

IP 44 0,66

## Dimensional drawing

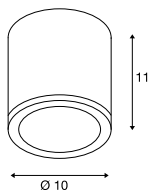

## Recommended lamp

GX53 3W 120°  
3000K 250lm  
3kWh/1000h  
Item No. 551372LED GX53 8.2W 120°  
4000K 620lm  
9kWh/1000h  
Item No. 550074

## Lamp details

max. 9W TCR-TSE  
Diameter: 7.5 cm max. L: 3.5 cm max.

Variant	Item No.
GX53   TCR-TSE	
white	231541
GX53   TCR-TSE	
anthracite	231545



231545 704



ENOLA ROUND S  
CL



- The light colour can be selected during installation using a switch

Product details

100-240V ~50/60Hz | 500mA  
Total wattage: 9W  
Material: aluminium/glass

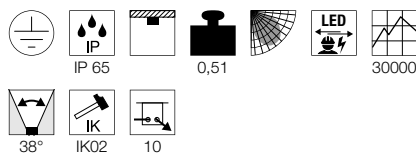

Dimensional drawing

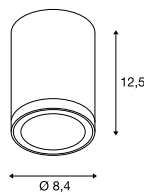

Variant	Item No.
510/580lm   3000/4000K   CRI>90 ■ matt anthracite	1003426

ENOLA ROUND M  
CL



- The light colour can be selected during installation using a switch

Product details

100-240V ~50/60Hz | 500mA  
Total wattage: 10W  
Material: aluminium/glass

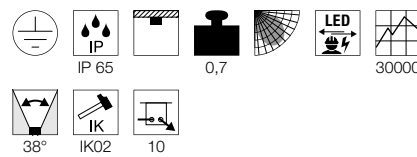

Dimensional drawing

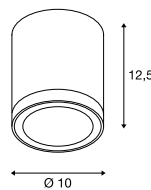

Variant	Item No.
700/800lm   3000/4000K   CRI>90 ■ matt anthracite	1003427

ENOLA ROUND L  
CL



- The light colour can be selected during installation using a switch

Product details

220-240V ~50/60Hz | 900mA  
Total wattage: 35W  
Material: aluminium/glass

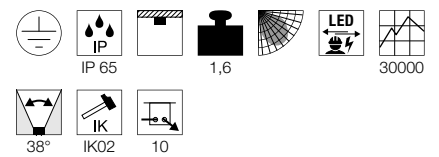

Dimensional drawing

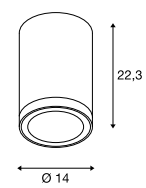

Variant	Item No.
2500/2800lm   3000/4000K   CRI>90 ■ matt anthracite	1003442

POLE PARC  
CL



ROX  
CL, GX53



ROX  
CL, QPAR111

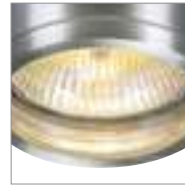

• High-quality brushed surface

• High-quality brushed surface

Product details

100-240V ~50/60Hz | 700mA  
Total wattage: 28W  
Material: aluminium/glass

Product details

230V -50Hz  
Material: aluminium/glass

Product details

230V -50Hz  
Material: aluminium/glass

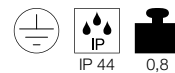
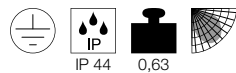

Dimensional drawing

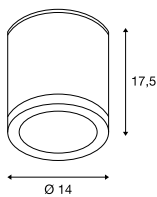

Dimensional drawing

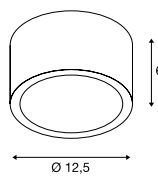

Dimensional drawing

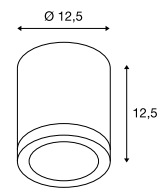

Recommended lamp

LED GX53 3W 120°  
3000K 250lm  
3kWh/1000h  
Item No. 551372



Recommended lamp

LED GU10 7.9W 25°  
2700K 730lm  
8kWh/1000h  
Item No. 560702



LED GU10 6.5W 38°  
2700K 390lm  
7kWh/1000h  
Item No. 551882



Lamp details

max. 11W TCR-TSE  
Diameter: 7.5 cm max. L: 3.5 cm max.

Lamp details

max. 50W QPAR111

Variant	Item No.
2900lm   3000K   CRI>80 ■ anthracite	1000447

Variant	Item No.
GX53   TCR-TSE □ aluminium	1000339

Variant	Item No.
GU10   QPAR111 □ aluminium	1000332



1000447 706

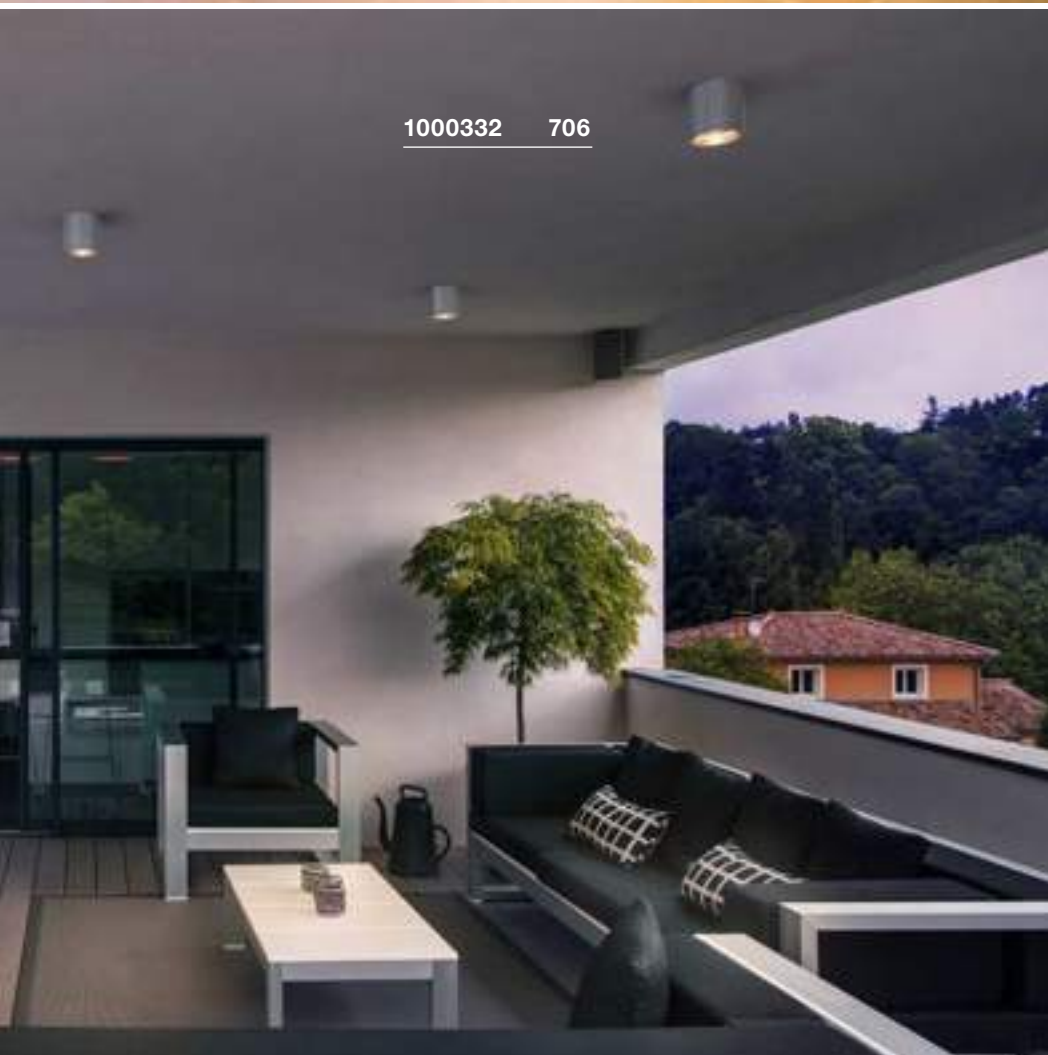

1000332 706

SQUARE  
CL, PHASE



LED  
INSIDE



- Lights made from high-quality 316 stainless steel
- Modern design
- Diffuse light distribution for even ground illumination

Product details

220-240V ~50/60Hz  
Total wattage: 12W  
Material: stainless steel 316  
Dimmable: C, L

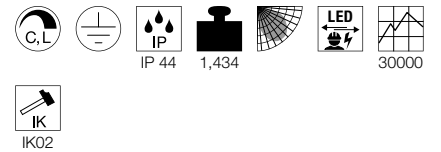

Dimensional drawing

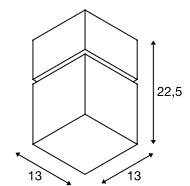

Variant	Item No.
760lm   3000K   CRI>80 ■ stainless steel	1000835

234535 709





**BIG THEO**  
CL, QPAR111



**SOCKET**  
INSIDE



**Product details**

230V -50Hz  
Material: aluminium/glass

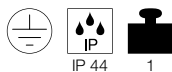

IP 44

1

**Dimensional drawing**

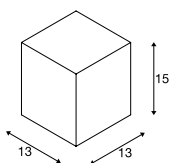

**Recommended lamp**

LED GU10 6.5W 38°  
2700K 390lm  
7kWh/1000h  
Item No. 551882



LED GU10 7.9W 40°  
4000K 760lm  
8kWh/1000h  
Item No. 560724



**Lamp details**

max. 75W QPAR111

Variant	Item No.
GU10   QPAR111	
□ white	229551
GU10   QPAR111	
■ grey	229554
GU10   QPAR111	
■ anthracite	229555

**BIG THEO**  
CL



**LED**  
INSIDE



**Product details**

100-277V ~50/60Hz | 500mA  
Total wattage: 21W  
Material: aluminium/glass



IP 44

1,3

30000

24°



IK02

**Dimensional drawing**

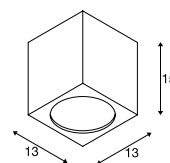

Variant	Item No.
2000lm   3000K   CRI>80	
■ anthracite	234535

ENOLA SQUARE S  
CL



NEW

LED  
INSIDE

CCT



Product details

100-240V ~50/60Hz | 500mA  
Total wattage: 9W  
Material: aluminium/glass

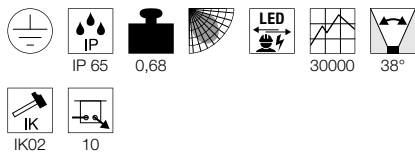

Dimensional drawing

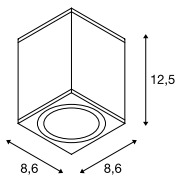

ENOLA SQUARE M  
CL



NEW

LED  
INSIDE

CCT



Product details

100-240V ~50/60Hz | 500mA  
Total wattage: 10W  
Material: aluminium/glass

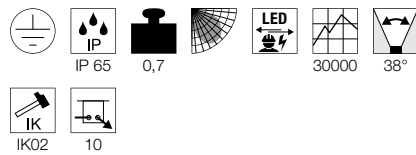

Dimensional drawing

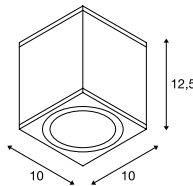

ENOLA SQUARE L  
CL



NEW

LED  
INSIDE

CCT



Product details

220-240V ~50/60Hz | 900mA  
Total wattage: 35W  
Material: aluminium/glass

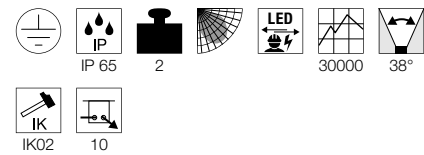

Dimensional drawing

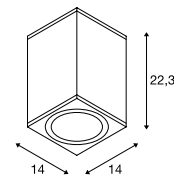

Variant	Item No.
510/580lm   3000/4000K   CRI>90 ■ anthracite	1003420

Variant	Item No.
700/800lm   3000/4000K   CRI>90 ■ anthracite	1003421

Variant	Item No.
2500/2800lm   3000/4000K   CRI>90 ■ anthracite	1003439



1003421 710

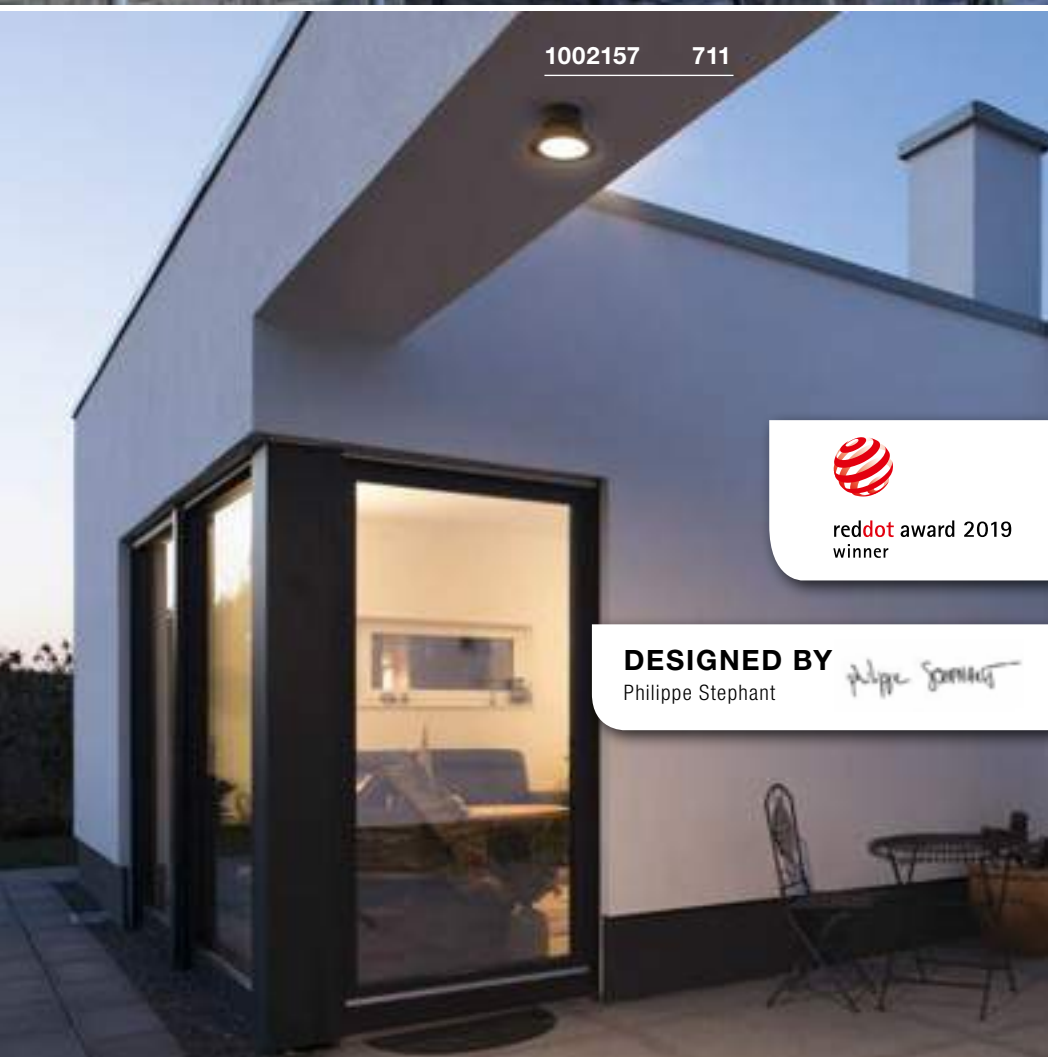

1002157 711



reddot award 2019  
winner

**DESIGNED BY**

Philippe Stephant

MALU  
CL



reddot award 2019  
winner



- Unusual design
- For even illumination

**Product details**

220-240V ~50/60Hz  
Total wattage: 9.2W  
Material: aluminium/glass



IP 44

0,7

35000

100°



IK 03

100

**Dimensional drawing**

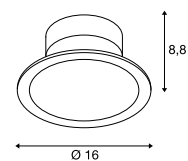

Variant	Item No.
360lm   3000K   CRI>80 ■ anthracite	1002157

AINOS  
CW



AINOS  
CW SENSOR



- Motion detector with microwave technology integrated in the light housing

Product details

100-277V ~50/60Hz | 500mA  
Total wattage: 21W  
Material: aluminium/polycarbonate (PC)

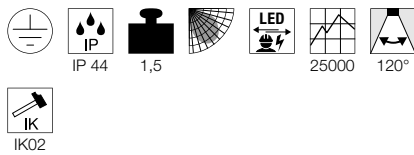

Dimensional drawing

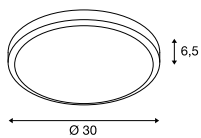

Product details

100-277V ~50/60Hz | 500mA  
Total wattage: 22W  
Material: aluminium/polycarbonate (PC)

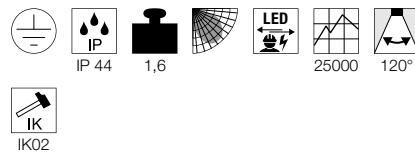

Dimensional drawing

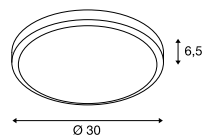

Tip

Movement sensor: the detection angle is 360°. The detection distance, ambient brightness, and operational time can be adjusted.



Variant	Item No.
1430lm   3000K   CRI>80	
white	229961
1430lm   3000K   CRI>80	
anthracite	229965

Variant	Item No.
1430lm   3000K   CRI>80	
white	229971
1430lm   3000K   CRI>80	
anthracite	229975





229975 712



**AINOS**  
CW, square



- The light colour can be selected during installation using a switch

**Product details**

220-240V ~50/60Hz | 500mA  
Total wattage: 17W  
Material: aluminium/polycarbonate (PC)



IP 65

2,1

54000

**Dimensional drawing**

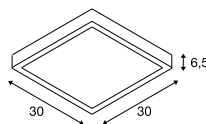

**AINOS**  
CW SENSOR, square



- The light colour can be selected during installation using a switch
- Motion detector with microwave technology integrated in the light housing

**Product details**

220-240V ~50/60Hz | 500mA  
Total wattage: 18W  
Material: aluminium/polycarbonate (PC)



IP 65

2,2

54000

**Dimensional drawing**

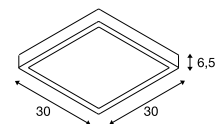

**Tip**

Movement sensor: the detection angle is 360°. The detection distance, ambient brightness, and operational time can be adjusted.

Variant	Item No.
1300lm   3000/4000K   CRI>80	
□ matt white	1003449
1300lm   3000/4000K   CRI>80	
■ anthracite	1003450

Variant	Item No.
1300lm   3000/4000K   CRI>80	
□ matt white	1003451
1300lm   3000/4000K   CRI>80	
■ anthracite	1003452

RUBA 27/42  
CW



- The light colour can be selected during installation using a switch
- Contains recycled material

Product details

220-240V ~50/60Hz | 600mA  
Material: Polycarbonate (PC)

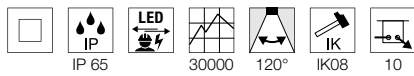

Dimensional drawing

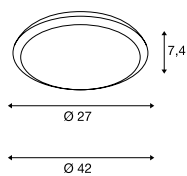

Variant	Item No.
985/1100lm   3000/4000K   CRI>90   12W Diameter: 27 cm   0.75 kg <input type="checkbox"/> white	<b>1005089</b>
2000/2270lm   3000/4000K   CRI>90   22W Diameter: 42 cm   1.67 kg <input type="checkbox"/> white	<b>1005090</b>

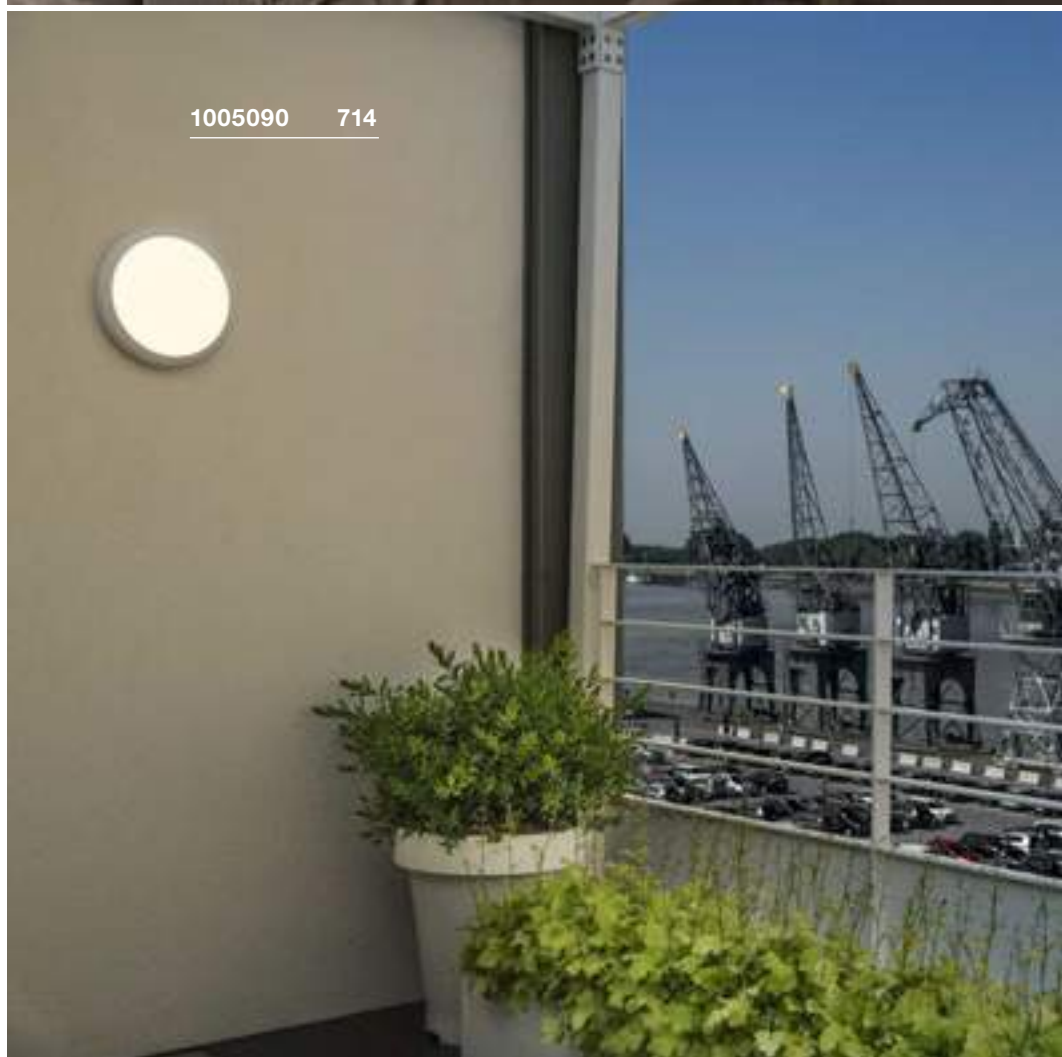



229085 715



229071 715

**BULAN GRID**  
CW, E27

SOCKET  
INSIDE



- Subtle design for a wide range of uses

**Product details**

230V -50Hz  
Material: aluminium/polycarbonate (PC)

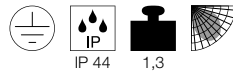

IP 44 1,3

**Dimensional drawing**

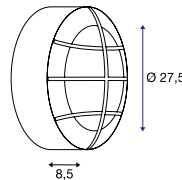

**BULAN**  
CW, E14

SOCKET  
INSIDE



**Product details**

230V -50Hz  
Material: aluminium/glass

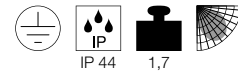

IP 44 1,7

**Dimensional drawing**

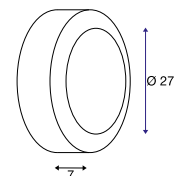

**Recommended lamp**

E27 9W 240°  
3000K 810lm  
10kWh/1000h  
Item No. 1001031



LED E27 15W 240°  
3000K 1521lm  
15kWh/1000h  
Item No. 1001033



**Lamp details**

2x max. 25W  
Diameter: 5.2 cm max. L: 17.3 cm max.

Variant	Item No.
E27	
□ white	229081
E27	
■ anthracite	229085

**Recommended lamp**

LED E14 4.5W 280°  
2700K 470lm  
5kWh/1000h  
Item No. 1002128



LED E14 6.5W 280°  
2700K 480lm  
7kWh/1000h  
Item No. 560372



**Lamp details**

max. 60W C35  
Diameter: 4.8 cm max. L: 13 cm max.

Variant	Item No.
E14   C35	
□ white	229071
E14   C35	
■ grey	229072
E14   C35	
■ anthracite	229075

LIPA  
CW, PHASE



- Colour temperature (3000K/4000K) can be adjusted using the switch
- unusual design

Product details

220-240V ~50/60Hz | 500mA  
 Total wattage: 24W  
 Material: aluminium/polycarbonate (PC)  
 Dimmable: C

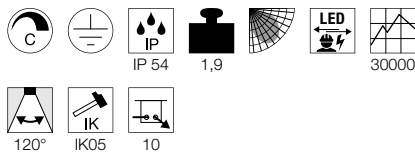

Dimensional drawing

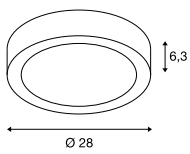

Variant	Item No.
1600lm   3000/4000K   CRI>80	
white	1001855
1500lm   3000/4000K   CRI>80	
anthracite	1001856

TERANG 200  
CW



- High-voltage LED

Product details

220-240V ~50Hz  
Total wattage: 11W  
Material: aluminium/polycarbonate (PC)

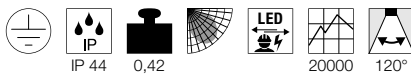

Dimensional drawing

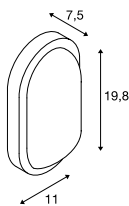

TERANG 270  
CW

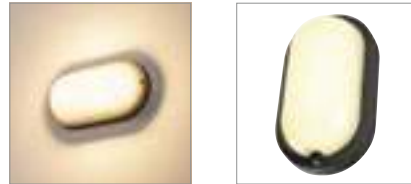

- High-voltage LED

Product details

220-240V ~50Hz  
Total wattage: 22W  
Material: aluminium/polycarbonate (PC)



Dimensional drawing

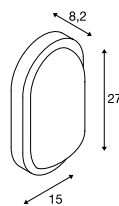

TERANG 270  
CW SENSOR



- High-voltage LED
- Motion detector with microwave technology integrated in the light housing

Product details

220-240V ~50Hz  
Total wattage: 23W  
Material: aluminium/polycarbonate (PC)



Dimensional drawing

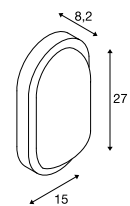

Tip

Movement sensor: the detection angle is 360°. The detection distance, ambient brightness, and operational time can be adjusted.

Variant	Item No.
680lm   3000K   CRI>80	
□ white	229931
680lm   3000K   CRI>80	
■ anthracite	229935

Variant	Item No.
1300lm   3000K   CRI>80	
□ white	229941
1300lm   3000K   CRI>80	
■ anthracite	229945

Variant	Item No.
1300lm   3000K   CRI>80	
□ white	229951
1300lm   3000K   CRI>80	
■ anthracite	229955

OUT-BEAM FRAME  
SP

NEW

LED  
INSIDE



- Exciting lighting effect
- Light beam width 3°
- 180° light emission left and right

Product details

100-277V ~50/60Hz | 700mA  
Total wattage: 3.5W  
Material: aluminium/acrylic

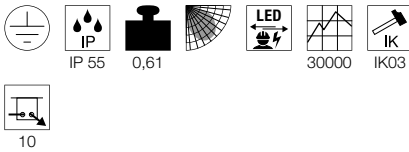

Dimensional drawing

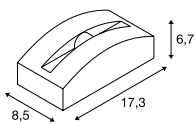

Variant	Item No.
60lm   3000K   CRI80 ■ anthracite	1003518
60lm   3000K   CRI80 □ white	1003519

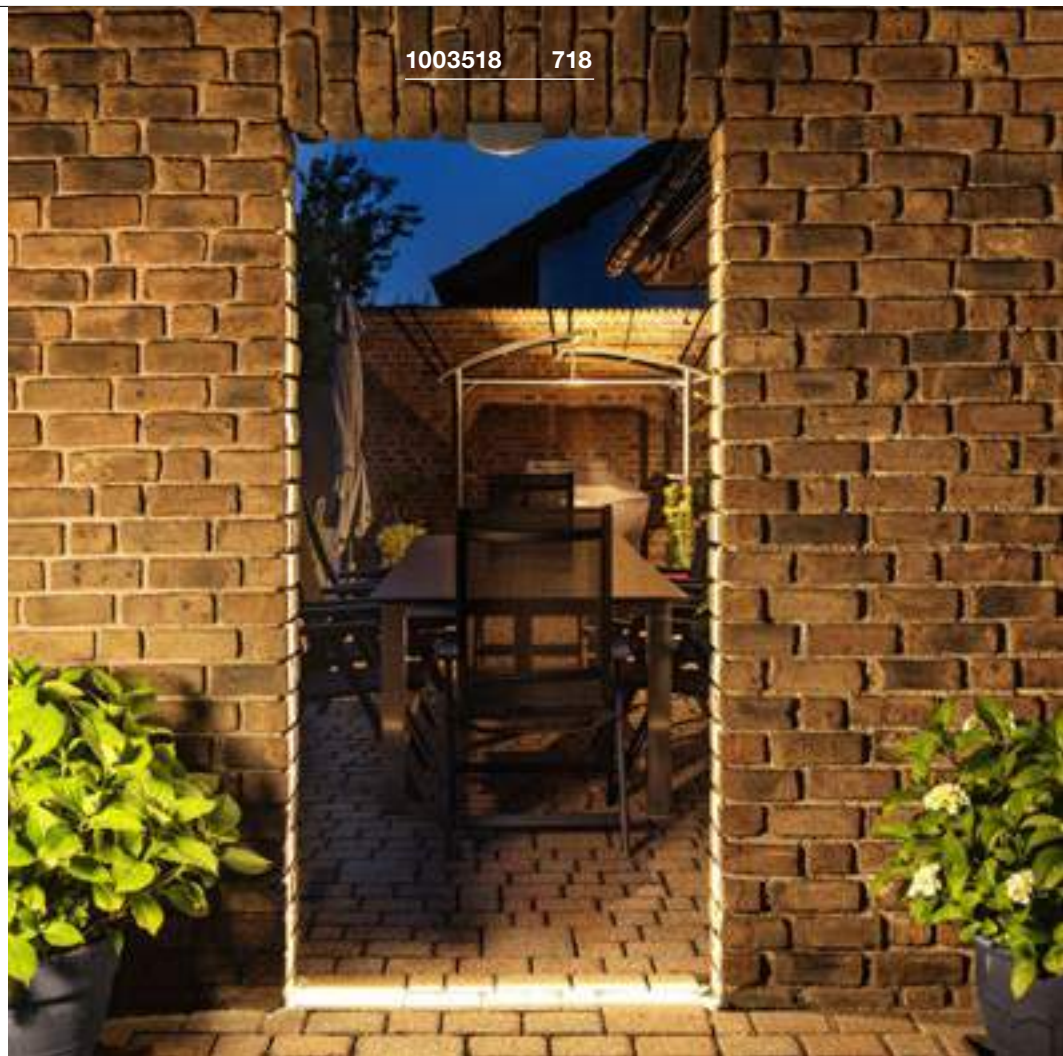

1003518 718

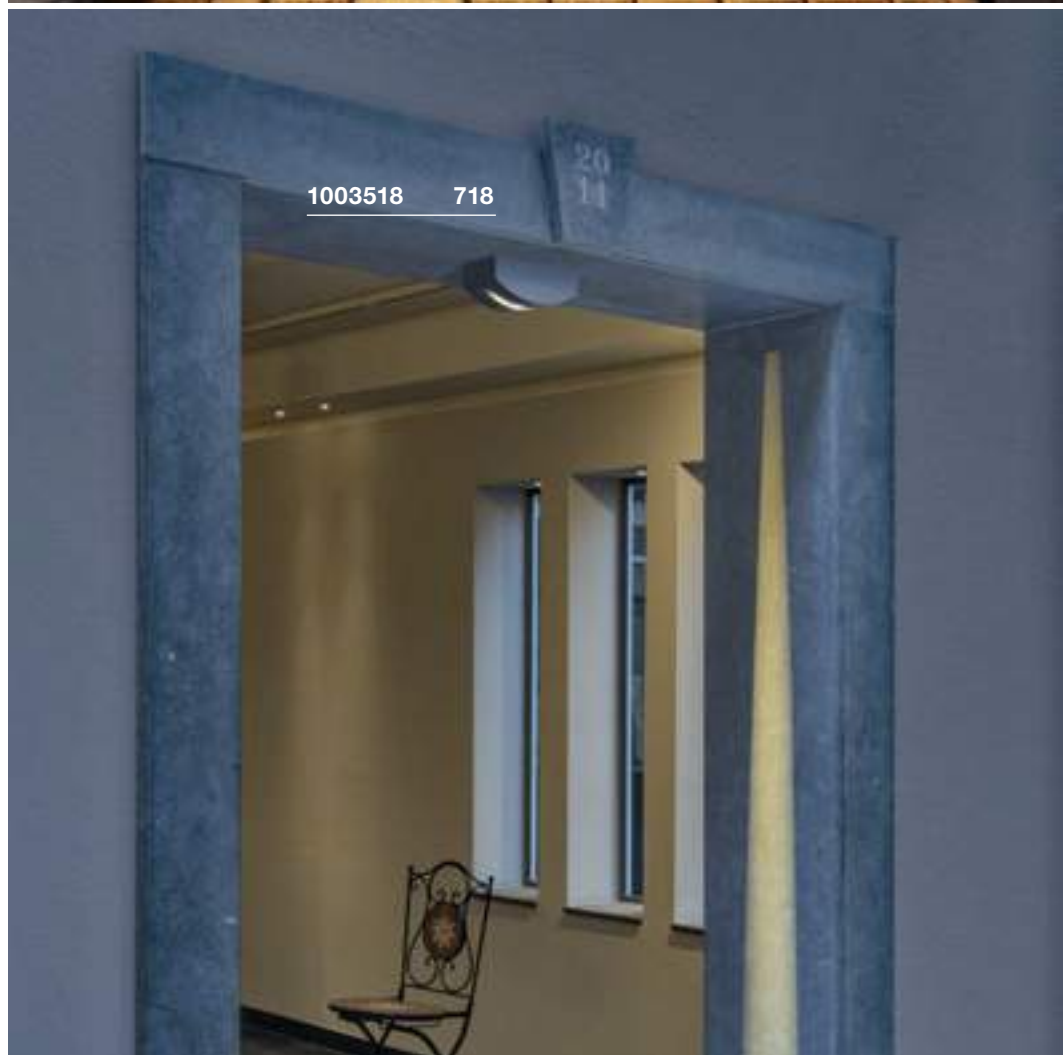

1003518 718

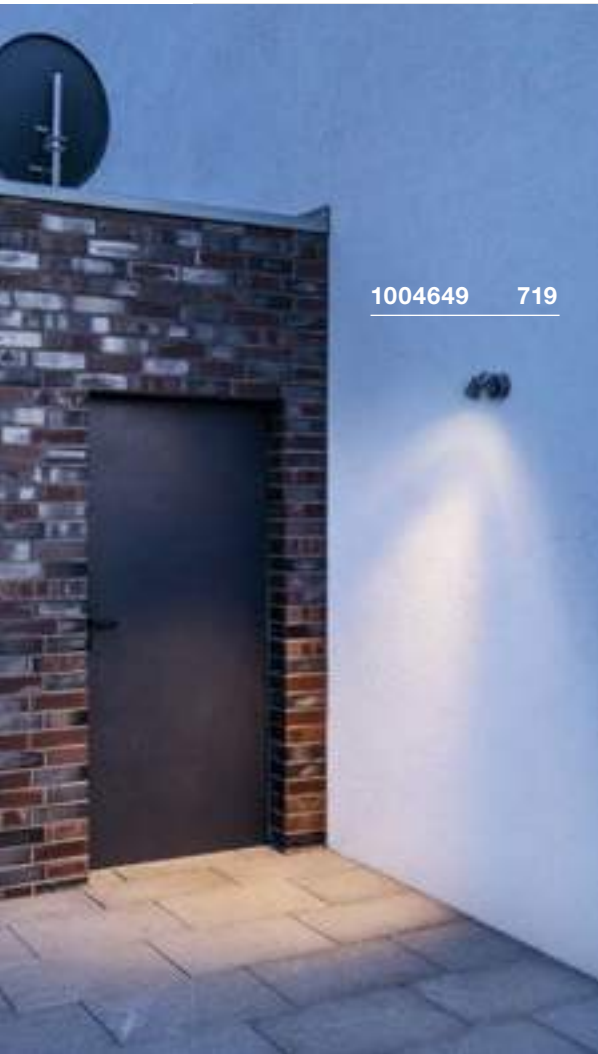

1004649 719



1004653 719

LED SPOT  
SP



THEO BRACKET  
CW



Product details

100-240V ~50/60Hz | 240mA  
Total wattage: 6W  
Material: aluminium/glass

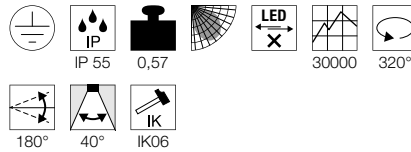

Product details

220-240V ~50/60Hz  
Material: aluminium/glass

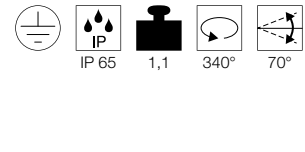

Dimensional drawing

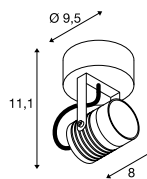

Dimensional drawing

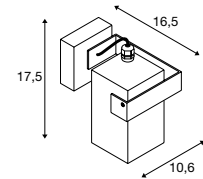

Recommended lamp

GU10 4W 36°  
2700K 300lm  
4kWh/1000h  
Item No. 1004972

LED GU10 5.5W 38°  
2700K 400lm  
6kWh/1000h  
Item No. 1001030



Recommended accessories

■ Mounting plate  
Item No. 1002884



Variant	Item No.
400lm   3000K   CRI>80	
■ anthracite	1004649
400lm   3000K   CRI>80	
■ brown	1004957

Lamp details

max. 7W LED GU10 51mm  
Diameter: 5.1cm max. L: 5.7cm max.

Variant	Item No.
GU10	
■ anthracite	1004653

NAUTILUS  
WL, square



NAUTILUS 10  
WL, square

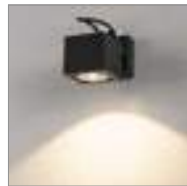

NAUTILUS 25  
WL, QPAR51



Product details

100-240V ~50/60Hz | 700mA  
Total wattage: 9W  
Material: aluminium/glass

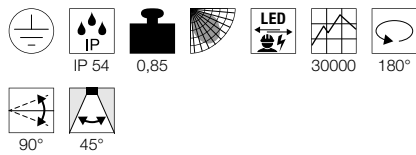

Dimensional drawing

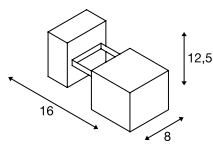

Product details

100-277V ~50/60Hz | 350mA  
Total wattage: 17W  
Material: aluminium/glass

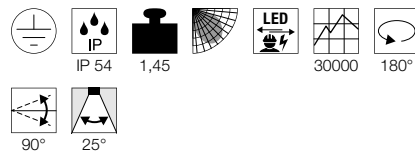

Dimensional drawing

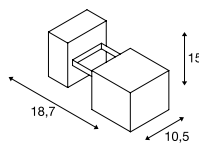

Product details

220-240V ~50/60Hz  
Material: aluminium

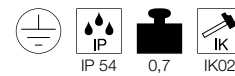

Dimensional drawing

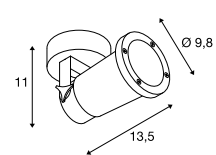

Recommended accessories

■ Mounting plate  
Item No. 1002884



Recommended lamp

GU10 4W 36°  
2700K 300lm  
4kWh/1000h  
Item No. 1004972



LED GU10 4W 36°  
3000K 300lm  
4kWh/1000h  
Item No. 1004973



Lamp details

max. 11W  
Diameter: 5 cm max. L: 8.3 cm max.

Variant	Item No.
520lm   3000K   CRI>80 ■ anthracite	231045

Variant	Item No.
950lm   3000K   CRI>80 ■ anthracite	231055

Variant	Item No.
GU10   QPAR51 ■ black	1002867





1002867 720



1002904 721

ESKINA SPOT  
CW, PHASE



- The light colour can be selected during installation using a switch

Product details

220-240V ~50/60Hz | 350mA  
Total wattage: 14.5W  
Material: aluminium  
Dimmable: C



Dimensional drawing

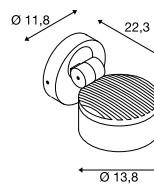

Variant	Item No.
1000lm   3000/4000K   CRI>80 ■ anthracite	1002903

ESKINA SPOT SENSOR  
CW, PHASE



- The light colour can be selected during installation using a switch

Product details

220-240V ~50/60Hz | 350mA  
Total wattage: 14.5W  
Material: aluminium  
Dimmable: C



Dimensional drawing

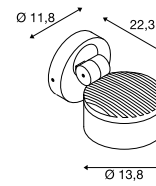

Tip

Motion sensor: Detection angle: 100°  
Detection range: max. 10m  
The ambient brightness and operational time can be adjusted.

Variant	Item No.
1000lm   3000/4000K   CRI>80 ■ anthracite	1002904

SITRA 360  
CW, TCR-TSE



SOCKET  
INSIDE



MYRA  
CW, single, QPAR51



SOCKET  
INSIDE



MYRA  
WL, double, QPAR51



SOCKET  
INSIDE

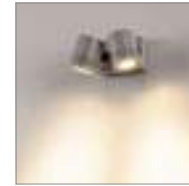

Product details

230V -50Hz  
Material: aluminium/glass



Dimensional drawing

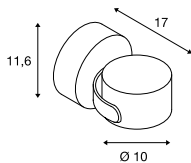

Product details

230V -50Hz  
Material: aluminium/glass



Dimensional drawing

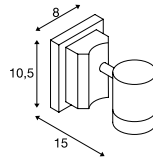

Tip

Adapter frame for surface mounting available

Recommended accessories

Surface mounting frames

Item No. 233214

Surface mounting frames

Item No. 233215

Recommended lamp

LED GX53 3W 120°  
3000K 250lm  
3kWh/1000h  
Item No. 551372



LED GX53 8.2W 120°  
4000K 620lm  
9kWh/1000h  
Item No. 550074



Lamp details

max. 9W TCR-TSE  
Diameter: 7.5 cm max. L: 3.5 cm max.

Variant	Item No.
GX53   TCR-TSE	
anthracite	231515

Recommended lamp

LED GU10 4W 36°  
3000K 300lm  
4kWh/1000h  
Item No. 1004973



LED GU10 6W 36°  
4000K 460lm  
6kWh/1000h  
Item No. 1005082



Lamp details

max. 50W QPAR51  
Diameter: 5cm max. L: 5.7cm max.

Variant	Item No.
GU10   QPAR51	
grey	233104
GU10   QPAR51	
anthracite	233105

Product details

220-240V ~50/60Hz  
Material: aluminium/glass

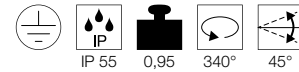

Dimensional drawing

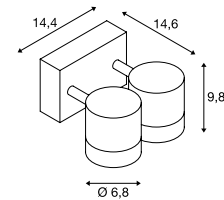

Recommended lamp

LED GU10 5.5W 38°  
2700K 400lm  
6kWh/1000h  
Item No. 1001030



LED GU10 6W 36°  
3000K 460lm  
6kWh/1000h  
Item No. 1005079



Lamp details

2x max. 50W QPAR51  
Diameter: 5cm max. L: 5.7cm max.

Variant	Item No.
GU10   QPAR51	
grey	233094
GU10   QPAR51	
anthracite	233095



233104 722



233105 722

HELIA  
CW, single, PHASE



HELIA  
CW, double, PHASE

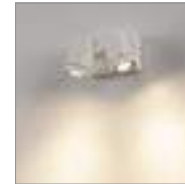
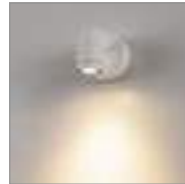

- High-voltage LED

- High-voltage LED

Product details

220-240V ~50/60Hz  
Total wattage: 8W  
Material: aluminium/glass  
Dimmable: C, L

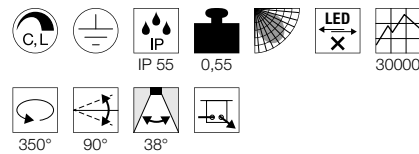

Product details

220-240V ~50/60Hz  
Total wattage: 16W  
Material: aluminium/glass  
Dimmable: C, L

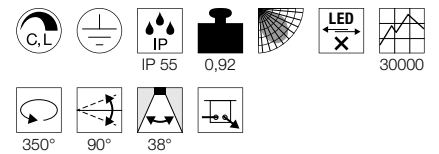

Dimensional drawing

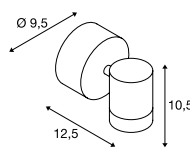

Dimensional drawing

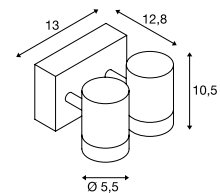

Variant	Item No.
450lm   3000K   CRI>80	
■ anthracite	233245
450lm   3000K   CRI>80	
□ white	233241

Variant	Item No.
900lm   3000K   CRI>80	
■ anthracite	233255
900lm   3000K   CRI>80	
□ white	233251

# TOUGH COOKIE.

## RECESSED FITTINGS – THE RELIABLE WAY OF LIGHTING.

---

Recessed fittings are a good alternative to suspended luminaires, particularly in the outdoor area, since they are individually adjustable and can be set, directed and flooded statically. And they are equipped to cope with any weather. Thanks to high-quality workmanship and materials and individual IP protection classes.



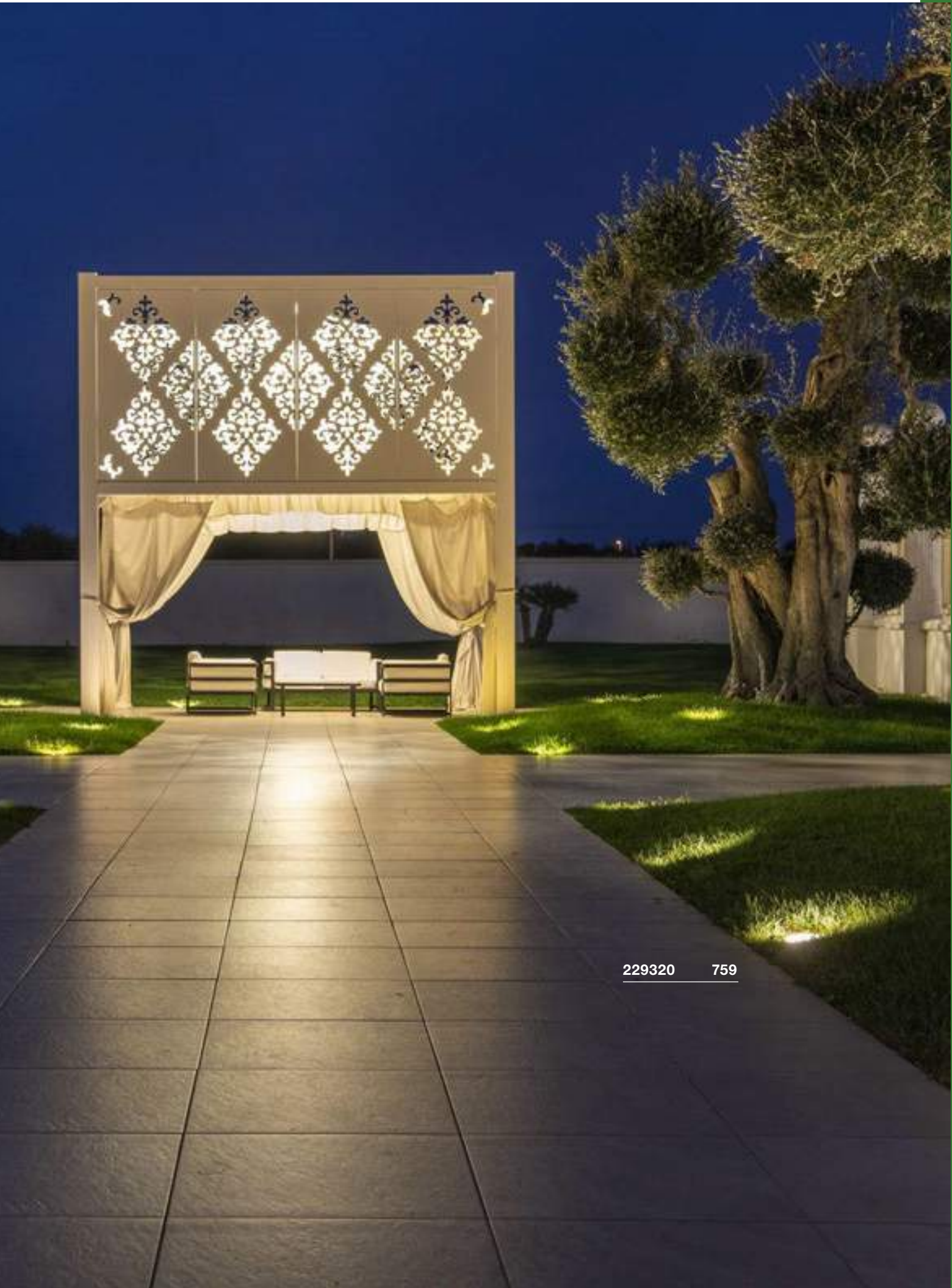

229320 759



1001017    743



## RECESSED LIGHTS



Other luminaires and variants can be found online at [www.slv.com](http://www.slv.com)  
 You can find manufacturer's details for our recommended lamps in the chapter 'Lightbulbs', from page 844

# RECESSED WALL LIGHTS

---





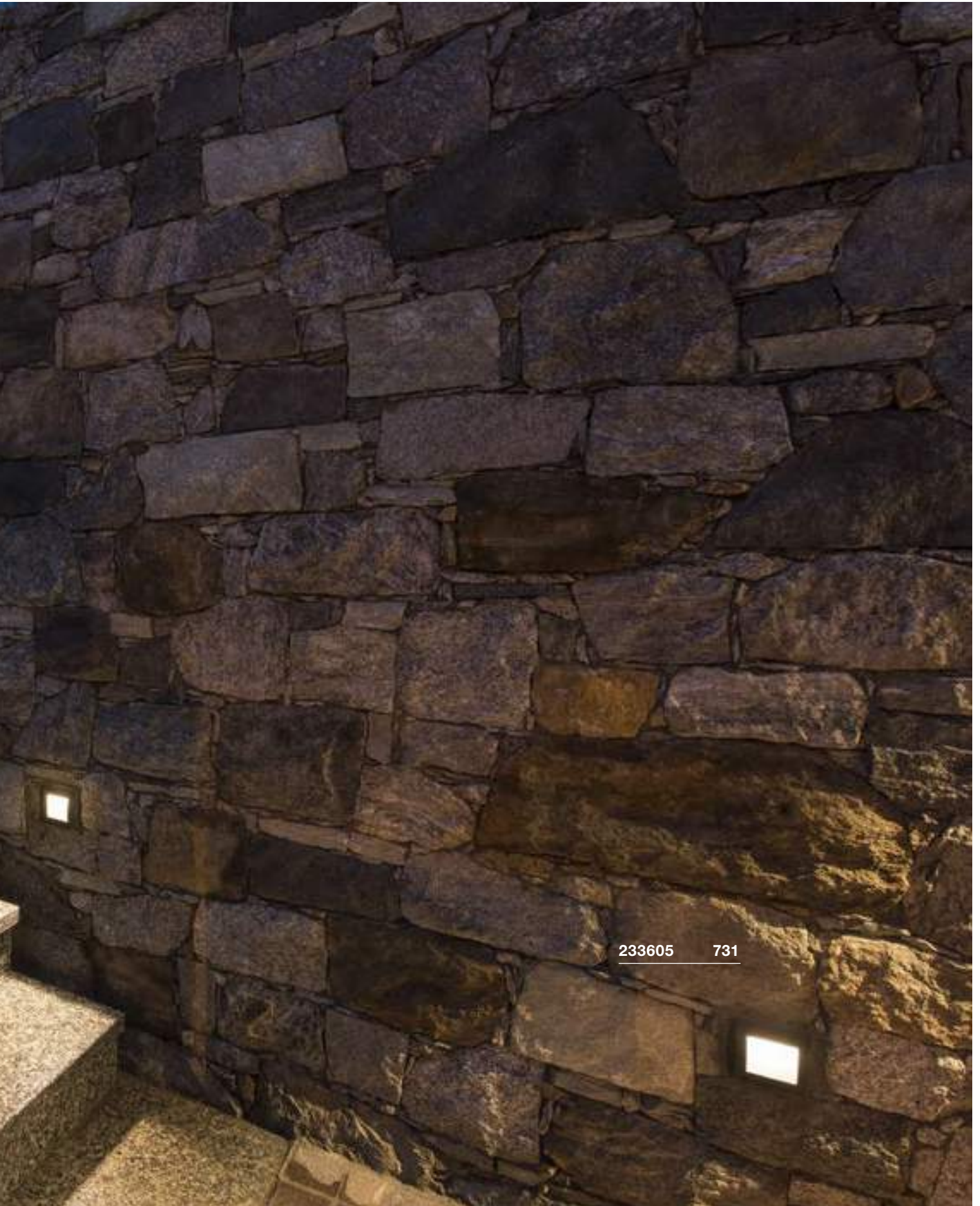

233605 731

**BRICK DOWNUNDER**  
EL, E14

SOCKET  
INSIDE



**BRICK DOWNUNDER**  
EL, E14

LED  
INSIDE



**Product details**

230V -50Hz  
Material: aluminium/glass



**Product details**

230V -50Hz  
Total wattage: 1.4W  
Material: aluminium/glass



**Dimensional drawing**

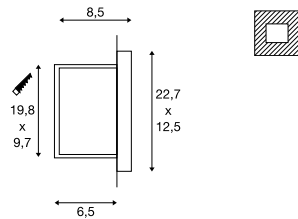

**Tip**

No recessed fixing kit required.

**Dimensional drawing**

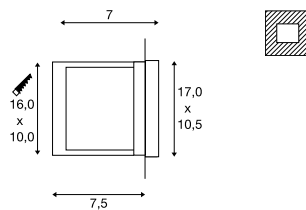

**Tip**

Mounting box included

**Recommended lamp**

LED E14 4.5W 280°  
2700K 470lm+  
5kWh/1000h  
Item No. 1002128



LED E14 6.5W 280°  
2700K 480lm  
7kWh/1000h  
Item No. 560372



**Lamp details**

max. 40W C35  
Diameter: 4.3 cm max. L: 12 cm max.

Variant	Item No.
E14   C35	
■ grey	229062

Variant	Item No.
30lm   3000K   CRI>80	
■ grey	229702

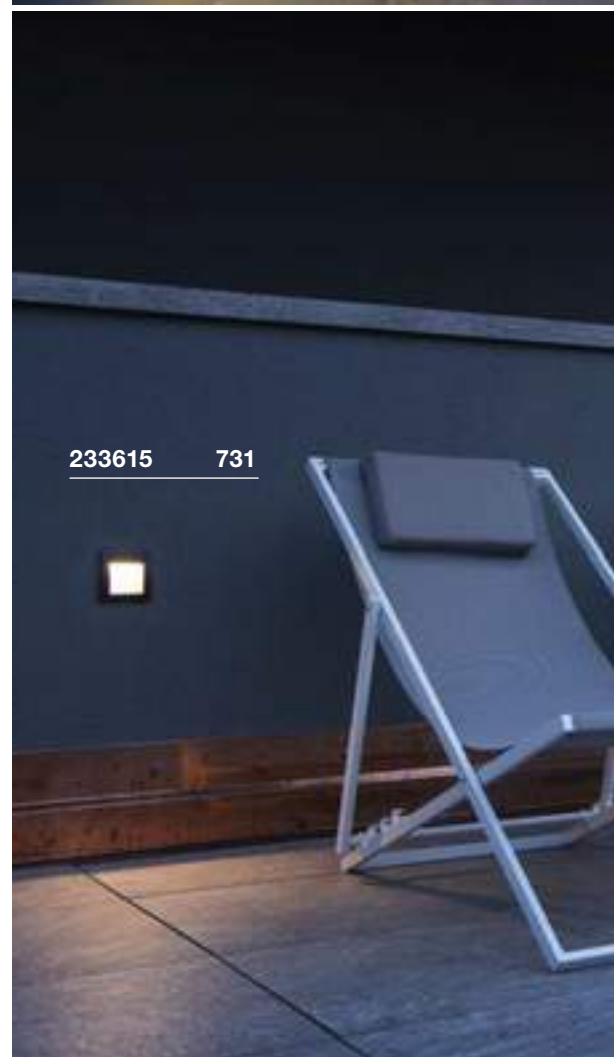



DOWNUNDER OUT S EL



DOWNUNDER OUT M EL



DOWNUNDER OUT L EL



Product details

220-240V ~50/60Hz | 20mA  
 Total wattage: 1.7W  
 Material: aluminium/plastic



Product details

220-240V ~50/60Hz | 20mA  
 Total wattage: 3.3W  
 Material: aluminium/plastic



Product details

220-240V ~50/60Hz | 20mA  
 Total wattage: 3.3W  
 Material: aluminium/plastic



Dimensional drawing

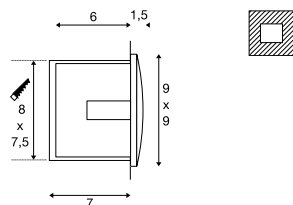

Tip

Mount the light only with the light beam pointing downwards. Max. diameter of connection cable 8.5 mm.  
 Mounting box included

Dimensional drawing

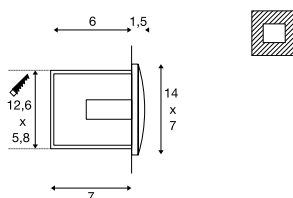

Tip

Mount the light only with the light beam pointing downwards. Max. diameter of connection cable 8.5 mm.  
 Mounting box included

Dimensional drawing

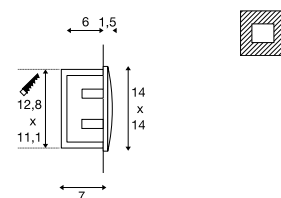

Tip

Mount the light only with the light beam pointing downwards. Max. diameter of connection cable 8.5 mm.  
 Mounting box included

Variant	Item No.
40lm   3000K   CRI>80 white	233601
25lm   3000K   CRI>80 anthracite	233605

Variant	Item No.
155lm   3000K   CRI>80 white	233621
85lm   3000K   CRI>80 anthracite	233625

Variant	Item No.
155lm   3000K   CRI>80 white	233611
85lm   3000K   CRI>80 anthracite	233615

ADI  
EL



**Product details**

100-277V ~50/60Hz | 500mA  
 Total wattage: 18W  
 Material: aluminium/polycarbonate (PC)



**Dimensional drawing**

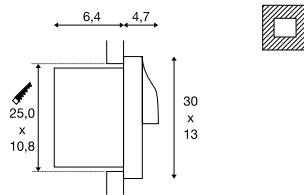

**Tip**

Mount the light only with the light beam pointing downwards.

**Recommended accessories**

■ Recessed fixing kit  
 Item No. 233639

Variant	Item No.
870lm   3000K   CRI>80 ■ anthracite	233635



233635 732



233650 733



**BRICK MESH**  
EL

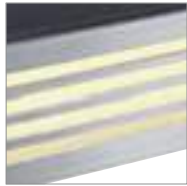
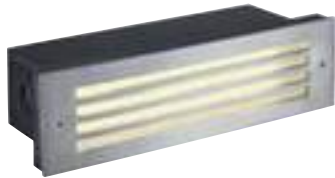

- Shade: stainless steel 316

**Product details**

100-240V ~50/60Hz | 24V DC  
Total wattage: 3.7W  
Material: stainless steel 316/glass



**Dimensional drawing**

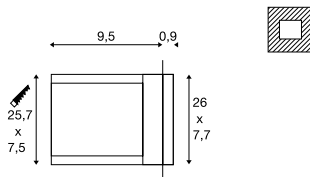

**Tip**

Mounting box included

Variant	Item No.
52lm   3000K   CRI>80 ■ stainless steel	229110

**BRICK**  
EL, symmetrical



- Symmetrical light emission
- Stainless steel 316L shade with aluminium housing

**Product details**

220-240V ~50/60Hz | 700mA  
Total wattage: 11W  
Material: aluminium/stainless steel 316

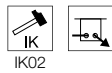

**Dimensional drawing**

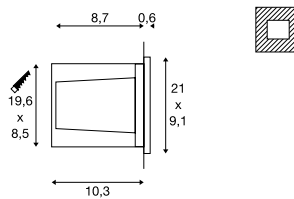

**Tip**

Mounting box included

Variant	Item No.
950lm   3000K   CRI>80 ■ stainless steel	233650

**BRICK**  
EL, asymmetrical



- Asymmetrical light emission
- Stainless steel 316L shade with aluminium housing

**Product details**

220-240V ~50/60Hz | 700mA  
Total wattage: 11W  
Material: aluminium/stainless steel 316

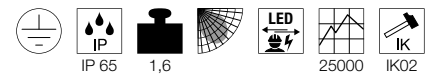

**Dimensional drawing**

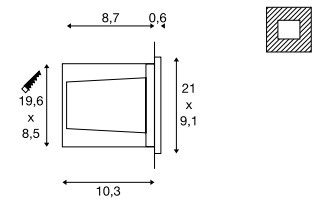

**Tip**

Mounting box included

Variant	Item No.
850lm   3000K   CRI>80 ■ stainless steel	233660

# RECESSED CEILING LIGHT

---



114421 742





1000833 737

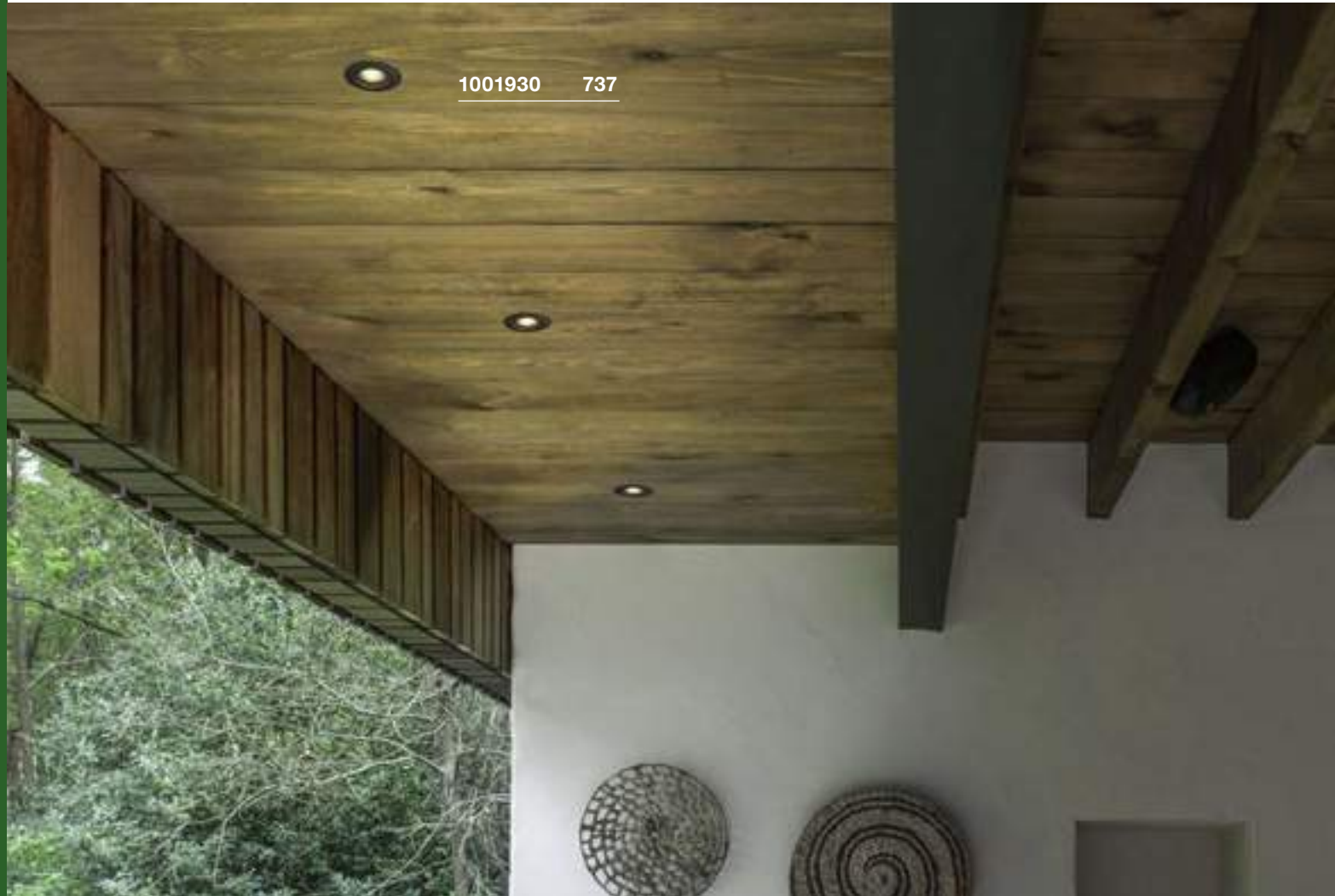

1001930 737



VARU  
EL, QPAR51

SOCKET  
INSIDE



- High IP rating
- Resilient housing

Product details

230V~50Hz  
Material: aluminium/glass

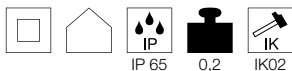

Dimensional drawing

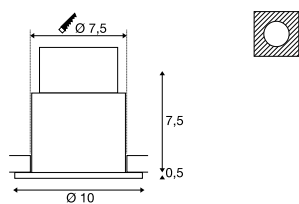

Tip

Material thickness of mounting surface: 15 mm

Recommended lamp

LED 6W 36°  
2700K 460lm  
6kWh/1000h  
Item No. 1005075



LED GU10 4W 36°  
2700K 300lm  
4kWh/1000h  
Item No. 1004972



Lamp details

max. 5W LED GU10 51mm  
Diameter: 5 cm max. L: 4.6 cm max.

Variant	Item No.
GU10   LED GU10 51mm	
■ black	1001930
GU10   LED GU10 51mm	
□ white	1001931

VARU  
EL

LED  
INSIDE



- High IP rating
- Resilient housing
- Glare reduction thanks to recessed LED

Product details

350mA | 5W  
Material: aluminium/glass

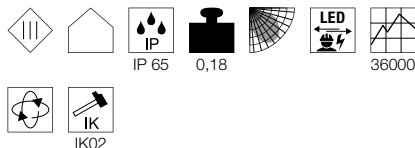

Dimensional drawing

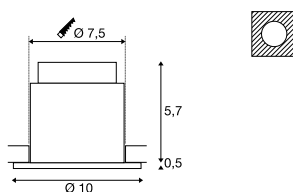

Tip

Material thickness of mounting surface: 15 mm  
Driver not included

Recommended accessories

- LED driver 350mA | 9W  
Item No. 464109
- Honeycomb filter  
Item No. 1001934



Variant	Item No.
400lm   2700K   CRI>80	
■ black	1001932
400lm   2700K   CRI>80	
□ white	1001933

KINI  
EL, PHASE

LED  
INSIDE



- Suitable for wet rooms
- Pivoting

Product details

220-240V ~50/60Hz | 260mA  
Total wattage: 12W  
Material: aluminium/polycarbonate (PC)  
Dimmable: C, L

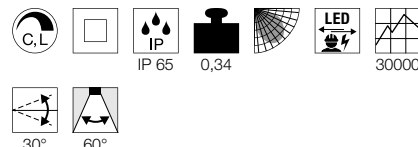

Dimensional drawing

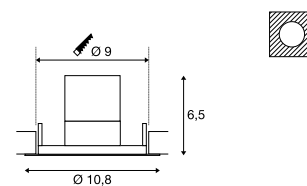

Tip

Material thickness of mounting surface: 5-20 mm

Variant	Item No.
850lm   3000K   CRI>80	
□ white	1000833

**DOLIX OUT**  
EL, round, QPAR51

SOCKET  
INSIDE



**DOLIX OUT**  
EL, square, QPAR51

SOCKET  
INSIDE

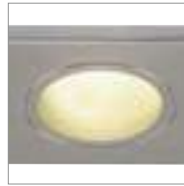
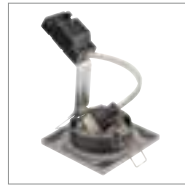

**Product details**

220-240V ~50/60Hz  
Material: aluminium/glass

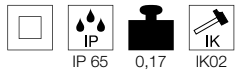

**Product details**

220-240V ~50/60Hz  
Material: aluminium/glass

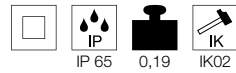

**Dimensional drawing**

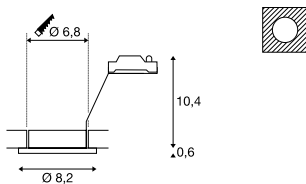

**Dimensional drawing**

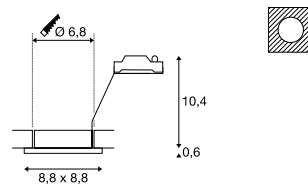

**Tip**

Material thickness of mounting surface: 20 mm

**Tip**

Material thickness of mounting surface: 20 mm

**Recommended lamp**

LED GU10 5.5W 38°  
2700K 400lm  
6kWh/1000h  
**Item No. 1001030**



LED 6W 36°  
2700K 460lm  
6kWh/1000h  
**Item No. 1005075**



**Recommended lamp**

LED GU10 3.7W 36°  
2700K 260lm  
4kWh/1000h  
**Item No. 560122**



LED GU10 4W 36°  
2700K 300lm  
4kWh/1000h  
**Item No. 1004972**



**Lamp details**

max. 50W QPAR51

**Lamp details**

max. 50W QPAR51

Variant	Item No.
GU10   QPAR51 white	1001165
GU10   QPAR51 chrome	1001166
GU10   QPAR51 silver grey	1001167
GU10   QPAR51 aluminium	1001168

Variant	Item No.
GU10   QPAR51 white	1001169
GU10   QPAR51 chrome	1001170
GU10   QPAR51 silver grey	1001171
GU10   QPAR51 aluminium	1001172



1001167 738



114460 739

OUT 65  
EL, round, PHASE

- High IR protection rating

## Product details

220-240V ~50/60Hz | 500mA  
 Total wattage: 11W  
 Material: aluminium/glass  
 Dimmable: C, L



38°

## Dimensional drawing

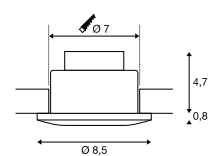

## Tip

Material thickness of mounting surface: 20 mm

Variant	Item No.
510lm   3000K   CRI>80	
■ black	114460
640lm   3000K   CRI>80	
□ white	114461

**PATTA-F**  
EL, round, PHASE



- High IR protection rating

**Product details**

220-240V ~50/60Hz | 500mA  
Total wattage: 11W  
Material: aluminium/glass  
Dimmable: C, L

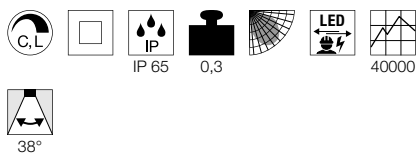

**Dimensional drawing**

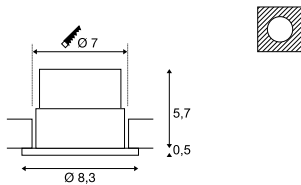

**Tip**

Material thickness of mounting surface: 20 mm

**PATTA-F**  
EL, square, PHASE

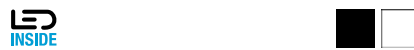

- High IR protection rating

**Product details**

220-240V ~50/60Hz | 500mA  
Total wattage: 11W  
Material: aluminium/glass  
Dimmable: C, L

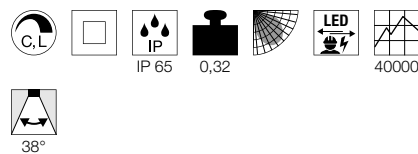

**Dimensional drawing**

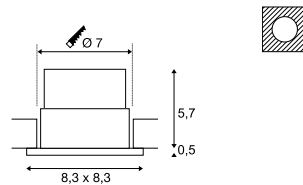

**Tip**

Material thickness of mounting surface: 20 mm

114441 740

Variant	Item No.
745lm   3000K   CRI>80	
■ black	114440
860lm   3000K   CRI>80	
□ white	114441

Variant	Item No.
745lm   3000K   CRI>80	
■ black	114450
860lm   3000K   CRI>80	
□ white	114451





**PATTA-I**  
EL, round, PHASE



- Premium LED with CRI>90
- Dim to Warm (1800-3000K)
- High IR protection rating

**Product details**

220-240V ~50/60Hz | 350mA  
Total wattage: 7.3W  
Material: aluminium/glass  
Dimmable: C, L

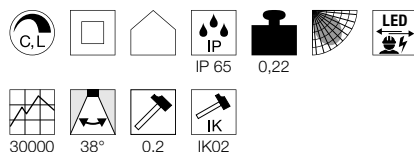

**Dimensional drawing**

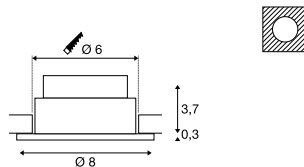

**Tip**

Products are delivered with spring clips.  
Leaf springs are included with the product and can be replaced.  
Material thickness of mounting surface: 20 mm

Variant	Item No.
440lm   1800-3000K   CRI>95	
■ black	<b>1002098</b>
440lm   1800-3000K   CRI>95	
□ white	<b>1002099</b>
440lm   1800-3000K   CRI>95	
■ aluminium	<b>1002100</b>

**PATTA-I**  
EL, square, PHASE



- Premium LED with CRI>90
- Dim to Warm (1800-3000K)
- High IR protection rating

**Product details**

220-240V ~50/60Hz | 350mA  
Total wattage: 7.3W  
Material: aluminium/glass  
Dimmable: C, L

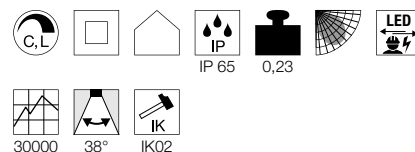

**Dimensional drawing**

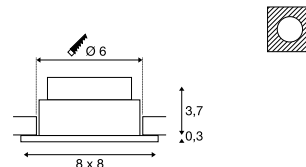

**Tip**

Products are delivered with spring clips.  
Leaf springs are included with the product and can be replaced.  
Material thickness of mounting surface: 20 mm

Variant	Item No.
440lm   1800-3000K   CRI95	
■ black	<b>1002101</b>
440lm   1800-3000K   CRI95	
□ white	<b>1002102</b>
440lm   1800-3000K   CRI95	
■ aluminium	<b>1002103</b>

PATTA-I  
EL, round, PHASE



• High IR protection rating

Product details

220-240V ~50/60Hz | 500mA  
Total wattage: 11W  
Material: aluminium/glass  
Dimmable: C, L

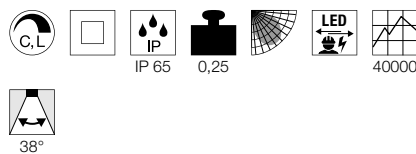

Dimensional drawing

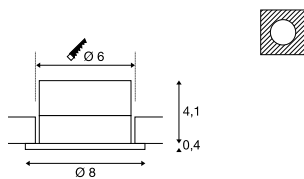

Tip

Material thickness of mounting surface: 25 mm

PATTA-I  
EL, square, PHASE



• High IR protection rating

Product details

220-240V ~50/60Hz | 500mA  
Total wattage: 11W  
Material: aluminium/glass  
Dimmable: C, L

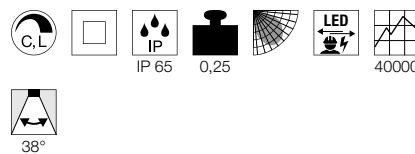

Dimensional drawing

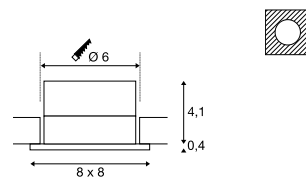

Tip

Material thickness of mounting surface: 25 mm



114421 742

Variant	Item No.
910lm   3000K   CRI>80	
■ black	114420
910lm   3000K   CRI>80	
□ white	114421
910lm   3000K   CRI>80	
■ aluminium	114426

Variant	Item No.
910lm   3000K   CRI>80	
■ black	114430
910lm   3000K   CRI>80	
□ white	114431
910lm   3000K   CRI>80	
■ aluminium	114436



## KAMUELA ECO EL, round, PHASE

LED  
INSIDE



1001017 743

- Fire resistant for at least 90 minutes compliant with BS 476-21
- IP 65 light with efficient LED technology

### Product details

220-240V ~50Hz  
Total wattage: 6.5W  
Material: aluminium/plastic  
Dimmable: C, L



### Dimensional drawing

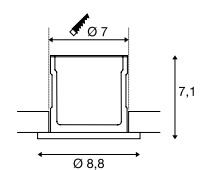

### Tip

Material thickness of mounting surface: max. 40 mm

Variant	Item No.
400lm   3000K   CRI>80	
■ black	1001015
400lm   3000K   CRI>80	
□ white	1001016
400lm   4000K   CRI>80	
■ black	1001017
400lm   4000K   CRI>80	
□ white	1001018

# RECESSED FLOOR LIGHT

---



229320    759





**BIG PLOT**  
Module



- Especially high IP protection rating
- A different light effect can be obtained with suitable covers

**Product details**

220-240V ~50/60Hz | 16mA  
Total wattage: 5.5W  
Material: aluminium/PMMA

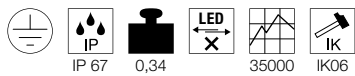

**Dimensional drawing**

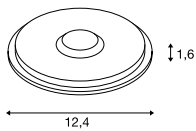

**Tip**

Open cable end  
This product is delivered without a cover.  
You can find suitable covers on page 747.

**Recommended accessories**

■ Connection box IP68, 3-pole  
Item No. 228730



Variant	Item No.
460lm   3000K   CRI>80	
■ silver grey	1001256

**BIG PLOT**  
Module



- Stainless steel 316
- Especially high IP protection rating
- A different light effect can be obtained with suitable covers

**Product details**

220-240V ~50/60Hz | 16mA  
Total wattage: 5.5W  
Material: stainless steel 316L/PMMA



**Dimensional drawing**

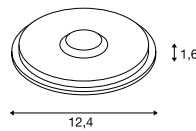

**Tip**

Open cable end  
This product is delivered without a cover.  
You can find suitable covers on page 747.

**Recommended accessories**

■ Connection box IP68, 3-pole  
Item No. 228730



Variant	Item No.
460lm   3000K   CRI>80	
■ stainless steel	1001359





1001255 747

**BIG PLOT**  
Cover, 2 slots

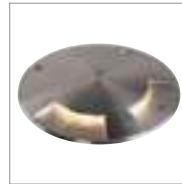

**Product details**

Material: 1001254/stainless steel 316  
Material 1001252/1001262: aluminium

**Dimensional drawing**

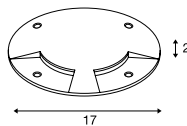

**Tip**

1001524 loadable up to 0.8t  
1001252 loadable up to 0.5t  
1001262 loadable up to 0.5t

**BIG PLOT**  
Cover, 4 slots



**Product details**

Material 1001255: Edelstahl316  
Material 1001253/1001263: aluminium

**Dimensional drawing**

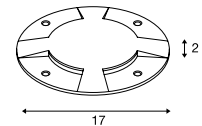

**Tip**

1001255 loadable up to 0.8t  
1001253 loadable up to 0.5t  
1001263 loadable up to 0.5t

Variant	Item No.
0.91 kg	
■ stainless steel	1001254
0.34 kg	
■ silver grey	1001252
0.34 kg	
■ anthracite	1001262

Variant	Item No.
0.85 kg	
■ stainless steel	1001255
0.33 kg	
■ silver grey	1001253
0.33 kg	
■ anthracite	1001263

TRAIL-LITE® 60  
EL

SOCKET  
INSIDE



- Shade: stainless steel 316

Product details

12V/0,3W

Material: stainless steel 316/glass



Dimensional drawing

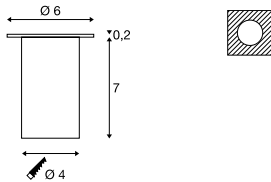

Tip

Operate only with conventional transformer.  
Mounting box included  
This light is suitable for installation in wood.  
Power adapter not included

Recommended accessories

■ Transformer 12V AC | 105VA IP44  
Item No. **227140**



Variant	Item No.
10lm   6500K   CRI>80 ■ stainless steel	<b>227461</b>
10lm   3000K   CRI>80 ■ stainless steel	<b>227462</b>



228332 749



227462 748



227461 748

**POWER TRAIL-LITE®**  
EL, round

SOCKET  
INSIDE



- Shade: stainless steel 316
- Premium LED

**Product details**

350mA | 1.4W  
Material: stainless steel 316/glass



**Dimensional drawing**

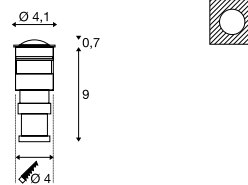

**Tip**

Operate only with 350mA driver. Only wire together multiple PowerLEDs in series!  
Mounting box included  
This light is suitable for installation in wood.  
LED driver not included

**Recommended accessories**

LED driver 350mA | 3W inc. strain relief

Item No. 464108

LED driver 350mA | 9W

Item No. 464109



Variant	Item No.
45lm   3000K   CRI>90	
■ stainless steel	228332
48lm   4000K   CRI>90	
■ stainless steel	1002189

**POWER TRAIL-LITE®**  
EL, square

SOCKET  
INSIDE

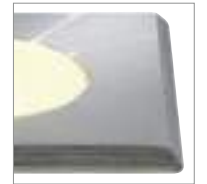

- Shade: stainless steel 316

**Product details**

350mA | 1.4W  
Material: stainless steel 316/glass



**Dimensional drawing**

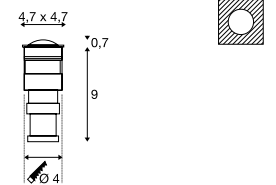

**Tip**

Operate only with 350mA driver. Only wire together multiple PowerLEDs in series!  
Mounting box included  
This light is suitable for installation in wood.  
LED driver not included

**Recommended accessories**

LED driver 350mA | 3W inc. strain relief

Item No. 464108

LED driver 350mA | 9W

Item No. 464109



Variant	Item No.
45lm   3000K   CRI>90	
■ stainless steel	228342

## SOLASTO

EL, square/round

SECKET  
INSIDE



### Product details

230V -50Hz

Material: plastic/stainless steel 304/glass

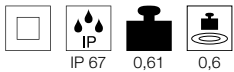

IP 67, 0,61, 0,6

### Dimensional drawing

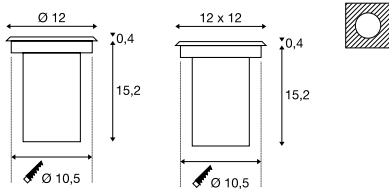

### Tip

Mounting box included

### Recommended lamp

LED GU10 4W 36°  
3000K 300lm  
4kWh/1000h  
Item No. 1004973



LED GU10 6W 36°  
2700K 460lm  
6kWh/1000h  
Item No. 1005075



### Lamp details

6W max.

Variant	Item No.
GU10   QPAR51	
○ ■ stainless steel	227680
GU10   QPAR51	
□ ■ stainless steel	227684

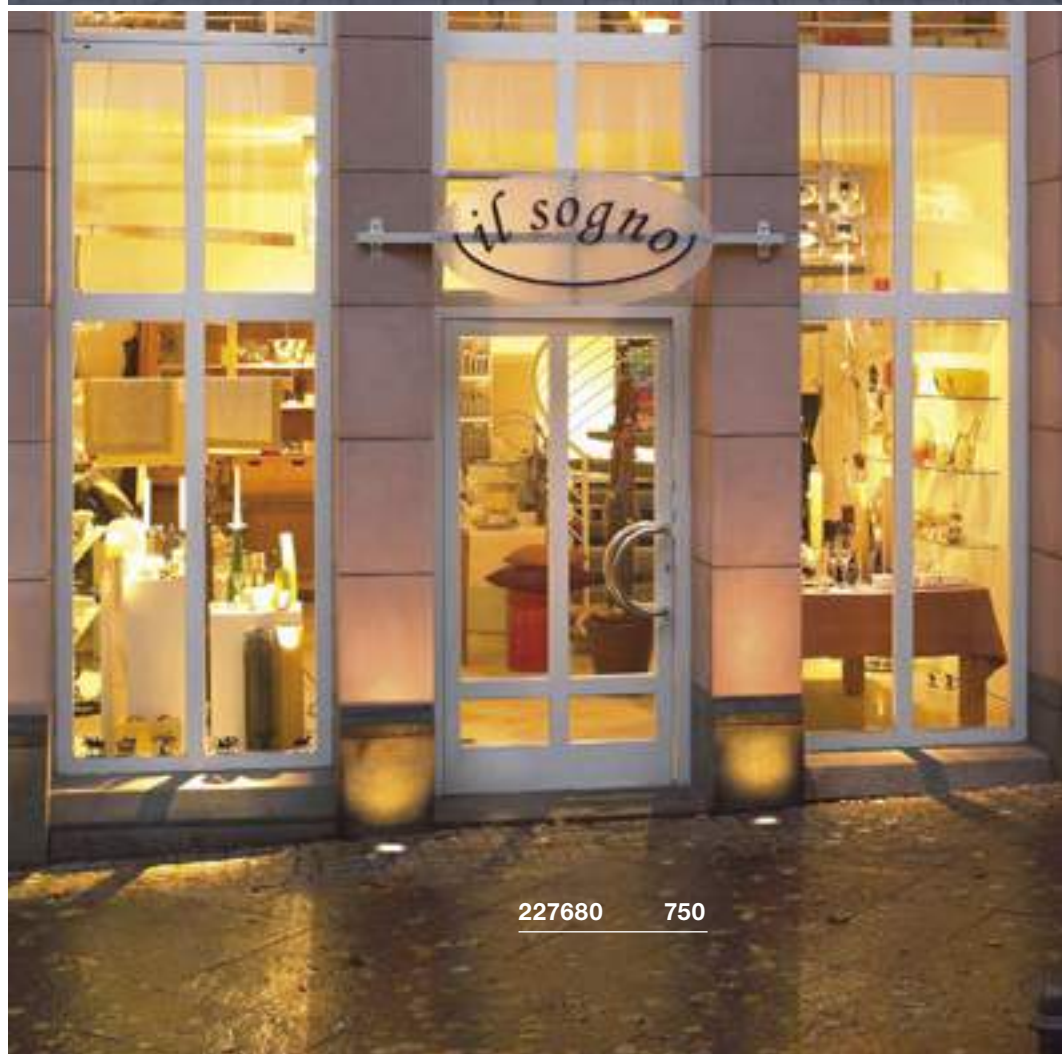

WETSY  
EL, square/round

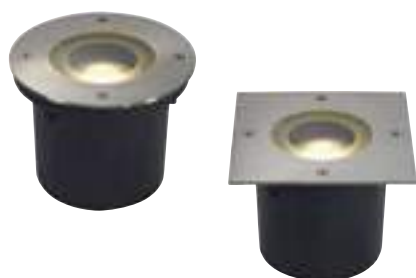

- Shade: stainless steel 316

Product details

220-240V ~50/60Hz  
Total wattage: 6.3W  
Material: stainless steel 316/aluminium/glass



Dimensional drawing

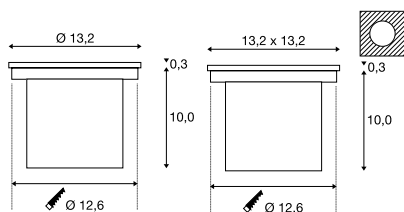

Tip

Mounting box included

ROCCI  
EL, round



- Shade: stainless steel 316
- Premium LED
- Must not be mounted in walking areas. (not safe to walk on)

Product details

200-240V ~50/60Hz 700mA  
Total output: 9.8W  
Material: stainless steel 316/aluminium/glass



Dimensional drawing

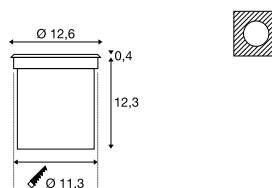

Tip

Mounting box included

ROCCI  
EL, square



- Shade: stainless steel 316
- Premium LED
- Must not be mounted in walking areas. (not safe to walk on)

Product details

200-240V ~50/60Hz 700mA  
Total output: 9.8W  
Material: stainless steel 316/aluminium/glass



Dimensional drawing

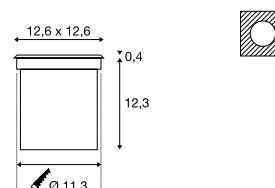

Tip

Mounting box included

Recommended accessories

■ Connection box IP68, 3-pole  
Item No. 228730

Variant	Item No.
300lm   3000K   CRI>80 ○ ■ stainless steel	230170
300lm   3000K   CRI>80 □ ■ stainless steel	230174

Variant	Item No.
580lm   3000K   CRI>80 ■ stainless steel	227600
630lm   4000K   CRI>80 ■ stainless steel	1002185

Variant	Item No.
580lm   3000K   CRI>80 ■ stainless steel	227604
630lm   4000K   CRI>80 ■ stainless steel	1002186

GIMBLE OUT  
EL

- Housing and shade: stainless steel 316L
- Premium LED

## Product details

220-240V ~50/60Hz 600mA  
Total wattage: 13W  
Material: stainless steel 316L/glass

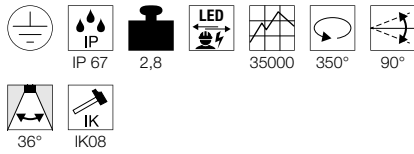

## Dimensional drawing

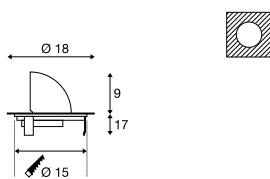

## Tip

Open cable end

## Recommended accessories

■ Installation pipe DN160

Item No. 233792

■ Connection box IP68, 3-pole

Item No. 228730

■ Floor-recessed fixing kit

Item No. 1000655



Variant	Item No.
1000lm   3000K   CRI>80 ■ stainless steel	1000384

1000384 752





**ADJUST 135**  
EL, square/round, QPAR51

SOCKET  
INSIDE



- Shade: stainless steel 304

**Product details**

230V -50Hz  
Material: plastic

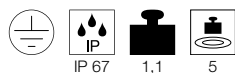

**Dimensional drawing**

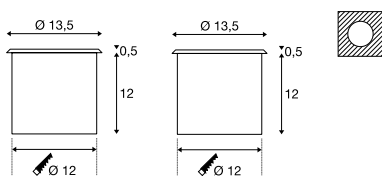

**Tip**

Mounting box included

**Recommended lamp**

LED GU10 6W 36°  
3000K 460lm  
6kWh/1000h  
Item No. 1005078



LED GU10 4W 36°  
4000K 300lm  
4kWh/1000h  
Item No. 1004974



Variant	Item No.
GU10   QPAR51	
■ stainless steel	228210
GU10   QPAR51	
■ stainless steel	228214

**ADJUST 190**  
EL, square/round, QR111

SOCKET  
INSIDE



- Shade: stainless steel 304
- Pivoting

**Product details**

230V ~50Hz 12V AC  
Material: stainless steel 304/aluminium/glass



**Dimensional drawing**

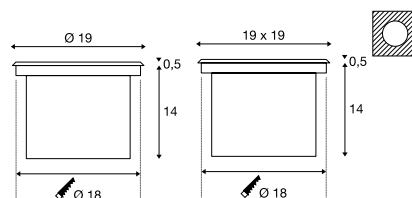

**Tip**

Mounting box included

**Recommended lamp**

LED G53 15W 24°  
2700K 760lm  
17kWh/1000h  
Item No. 560231



LED G53 15W 24°  
3000K 770lm  
17kWh/1000h  
Item No. 560233



**Lamp details**

50W max.  
optional: LED

Variant	Item No.
G53   QR111	
■ stainless steel	227090
G53   QR111	
■ stainless steel	227092

**ADJUST 265**  
EL, round, HIT-CE

SOCKET  
INSIDE



- Shade: stainless steel 304

**Product details**

230V -50Hz  
Material: stainless steel 304/aluminium/glass



**Dimensional drawing**

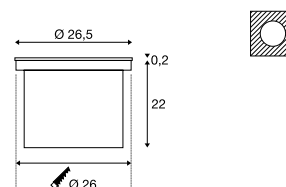

**Tip**

Mounting box included

**Lamp details**

70W

Variant	Item No.
G12   HIT-CE	
■ stainless steel	228240

# DASAR® FLAT 80 EL

SOCKET  
INSIDE



- Shade: stainless steel 304
- Ultra-flat design

### Product details

230V ~50/60Hz  
 Total wattage: 4.3W  
 Material: stainless steel 304/aluminium/glass

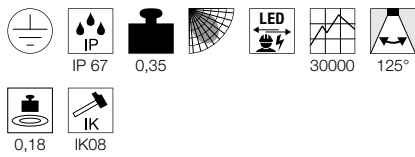

### Dimensional drawing

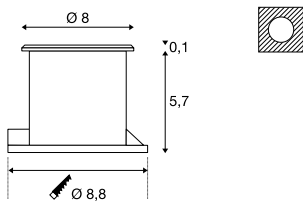

### Tip

Mounting box included

### Recommended accessories

■ Connection box IP68, 3-pole  
 Item No. 228730



Variant	Item No.
140lm   3000K   CRI>80 ■ stainless steel	228412
140lm   4000K   CRI>80 ■ stainless steel	1002188
150lm   5000K   CRI>80 ■ stainless steel	228411

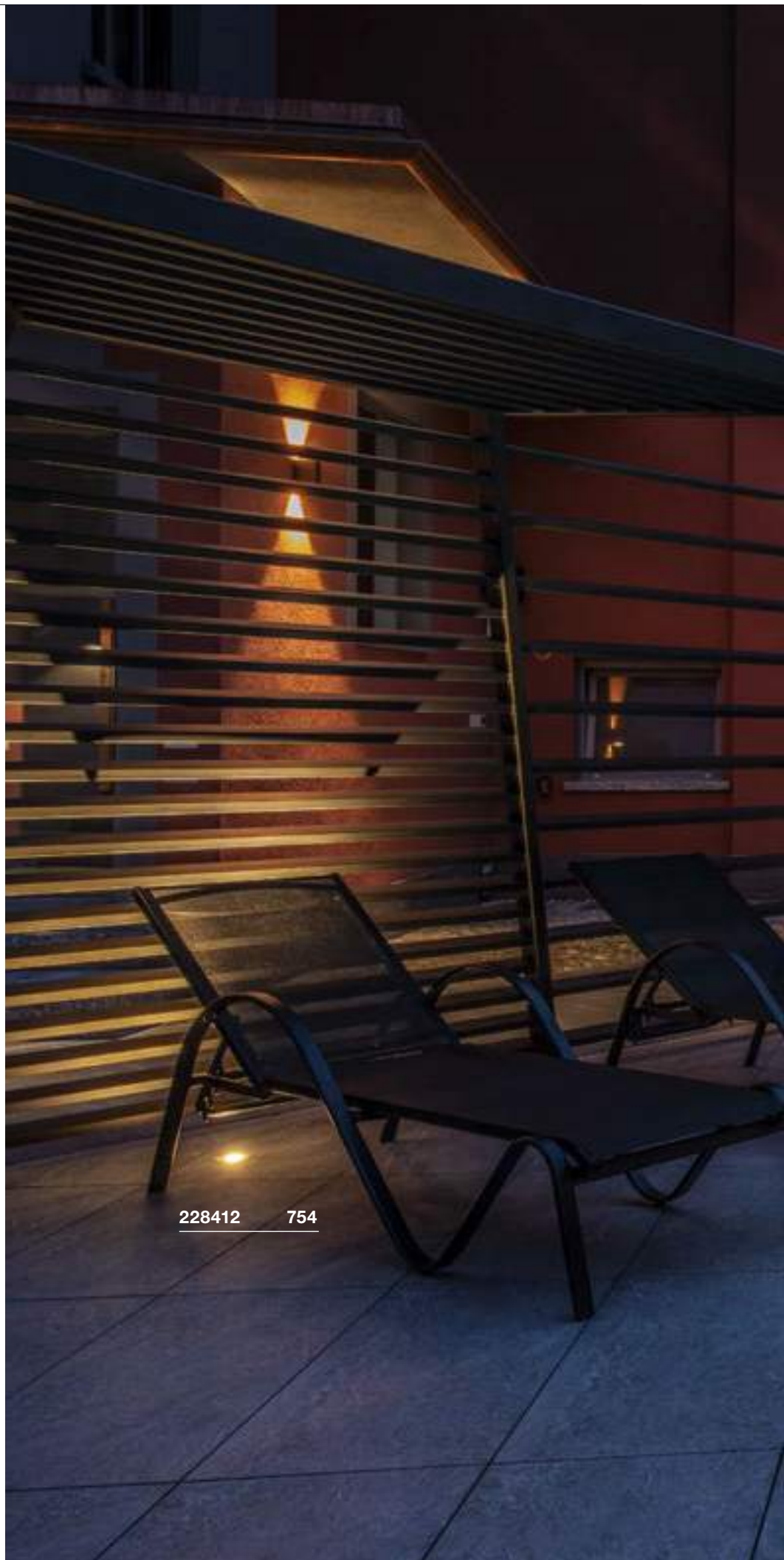

228412 754



233540 755

**DASAR® 370**  
EL, round

- Housing and shade: stainless steel 316L
- Premium LED

**Product details**

12V/24V DC | 2W

Material: stainless steel 316L/glass

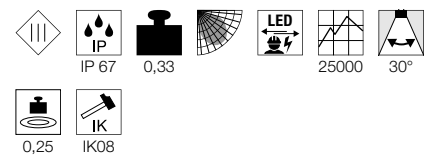
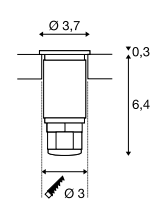
**Dimensional drawing****Tip**

Open cable end  
Power adapter not included

**Recommended accessories**
 LED power supply 24V DC | 12W

Item No. 470502

 LED Netzteil 12V DC | 12W

Item No. 470507

Variant	Item No.
120lm   3000K   CRI>80 ■ stainless steel	233540



233500 757

DASAR® 920 EL



- Shade: stainless steel 316
- Premium LED

Product details

12V DC / 24V DC | 7W  
Material: stainless steel 316/aluminium/glass

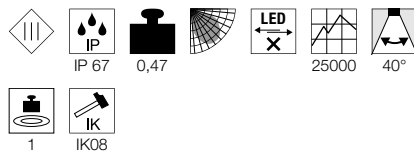

Dimensional drawing

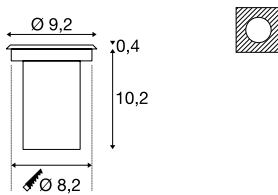

Tip

Mounting box included  
Open cable end

Recommended accessories

- LED power supply 24V DC | 12W  
Item No. 470502
- LED power supply 12V DC | 12W  
Item No. 470507

Variant	Item No.
360lm   3000K   CRI>80 ■ stainless steel	233500

DASAR® 920 EL



- Shade: stainless steel 316
- Premium LED

Product details

220-240V ~50/60Hz | 400mA  
Total wattage: 5.5W  
Material: stainless steel 316/aluminium/glass

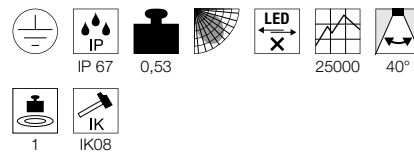

Dimensional drawing

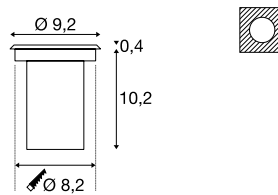

Tip

Mounting box included  
Open cable end

Variant	Item No.
300lm   3000K   CRI>80 ■ stainless steel	233520

DASAR® 920 EL



- Housing and shade: stainless steel 316
- Premium LED

Product details

220-240V ~50/60Hz | 400mA  
Total wattage: 5.5W  
Material: stainless steel 316/glass

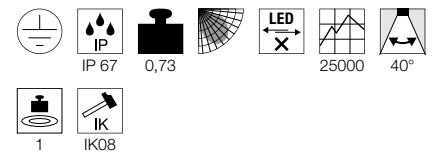

Dimensional drawing

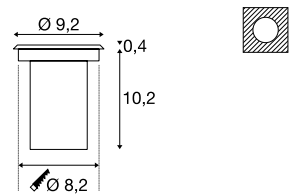

Tip

Mounting box included  
Open cable end

Variant	Item No.
300lm   3000K   CRI>80 ■ stainless steel	233530
360lm   4000K   CRI>80 ■ stainless steel	1002187

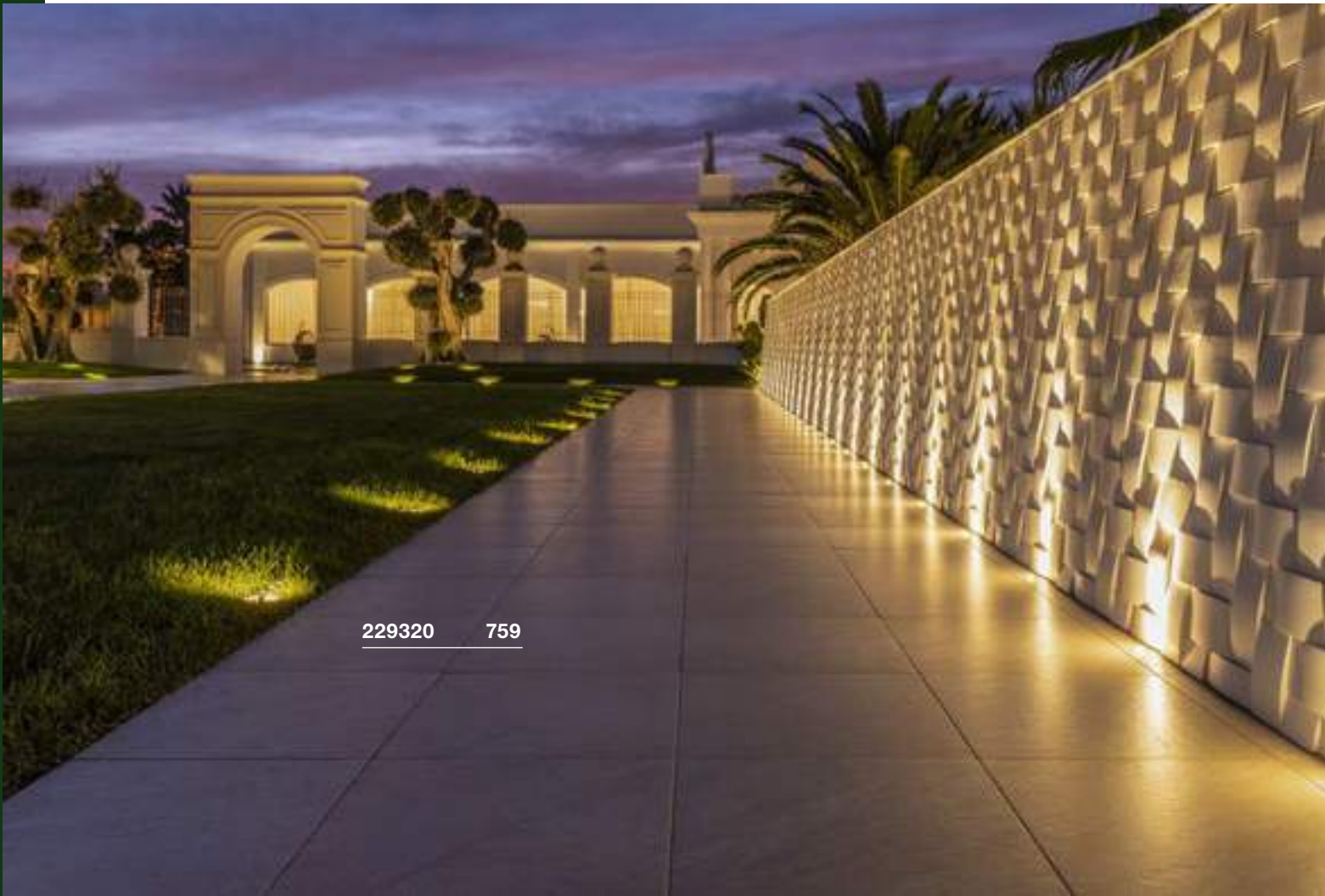

229320 759



229320 759



229324 759

**DASAR® 80**  
EL, square/round, QPAR51

SOCKET  
INSIDE



- Shade: stainless steel 316

**Product details**

230V -50Hz  
Material: stainless steel 316/aluminium/glass

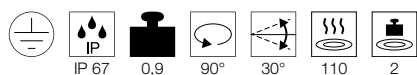

**Dimensional drawing**

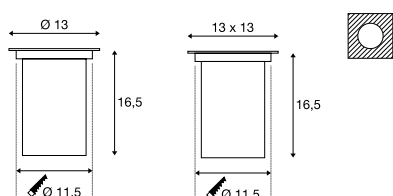

**Tip**

Mounting box included  
Driver not included

**Recommended lamp**

LED GU10 6W 36°  
3000K 460lm  
6kWh/1000h  
Item No. 1005080



LED GU10 4W 36°  
4000K 300lm  
4kWh/1000h  
Item No. 1004974



Variant	Item No.
GU10   QPAR51	
○ ■ stainless steel	229320
GU10   QPAR51	
□ ■ stainless steel	229324

**DASAR® 70**  
EL, square, QPAR51

SOCKET  
INSIDE



- Shade: stainless steel 304

**Product details**

230V -50Hz  
Material: stainless steel 304/aluminium/glass

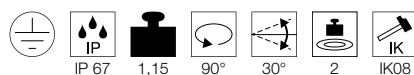

**Dimensional drawing**

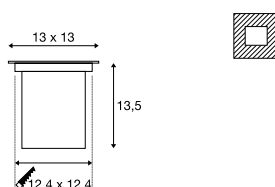

**Tip**

Mounting box included

**Recommended lamp**

LED 6W 36°  
2700K 460lm  
6kWh/1000h  
Item No. 1005075



LED GU10 4W 36°  
2700K 300lm  
4kWh/1000h  
Item No. 1004972



**Lamp details**

35W max.  
Diameter: 5 cm max. L: 6 cm max.  
optional: LED

Variant	Item No.
GU10   QPAR51	
■ stainless steel	229374

**DASAR® EXACT 116**  
EL, square/round, QPAR51

SOCKET  
INSIDE



- Shade: stainless steel 316
- For installation flush with the floor

**Product details**

230V -50Hz  
Material: stainless steel 316/aluminium/glass



**Dimensional drawing**

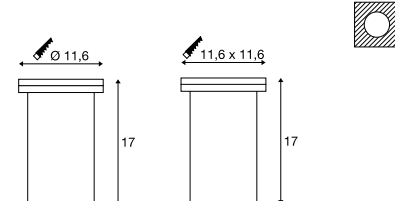

**Tip**

Mounting box included

**Recommended lamp**

LED GU10 5.5W 38°  
2700K 400lm  
6kWh/1000h  
Item No. 1001030



LED GU10 6W 36°  
3000K 460lm  
6kWh/1000h  
Item No. 1005079



**Lamp details**

35W max.  
Diameter: 5 cm max. L: 6 cm max.  
optional: LED

Variant	Item No.
GU10   QPAR51	
○ ■ stainless steel	228430
GU10   QPAR51	
□ ■ stainless steel	228434

**DASAR® 215**  
EL, square/round, QPAR111

SOCKET  
INSIDE



- Shade: stainless steel 316
- Linear, high-quality design for the highest level of adaptability

**Product details**

230V -50Hz  
Material: stainless steel 316/aluminium/glass

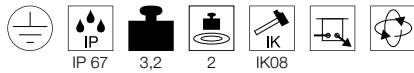

**Dimensional drawing**

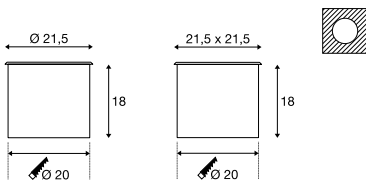

**Tip**

Mounting box included

**Recommended lamp**

LED GU10 13W 30°  
4000K 1100lm  
13kWh/1000h  
Item No. 1003087



LED GU10 13W 140°  
4000K 1000lm  
13kWh/1000h  
Item No. 1003088



**Lamp details**

75W max.  
optional: LED

Variant	Item No.
GU10   QPAR111	
○ stainless steel	229230
■ stainless steel	229234

**DASAR® 218**  
EL, QR111

SOCKET  
INSIDE



- Shade: stainless steel 316
- Larger swivel range than conventional recessed floor spots

**Product details**

230V ~50Hz 12V AC  
Material: stainless steel 316/aluminium/glass



**Dimensional drawing**

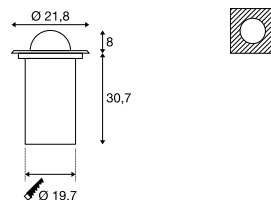

**Tip**

Mounting box included

**Recommended lamp**

LED G53 15W 24°  
2700K 760lm  
17kWh/1000h  
Item No. 560231



LED G53 15W 24°  
3000K 770lm  
17kWh/1000h  
Item No. 560233



**Lamp details**

50W max.  
optional: LED

Variant	Item No.
G53   QR111	
○ stainless steel	228370

**DASAR® 215**  
EL, round, E27

SOCKET  
INSIDE



- Shade: stainless steel 316
- Linear, high-quality design for the highest level of adaptability

**Product details**

230V -50Hz  
Material: stainless steel 316/aluminium/glass



**Dimensional drawing**

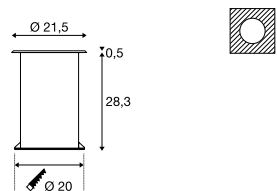

**Tip**

Surface temperature: Energysaver = 48°C/  
PAR 30 = 119°C/ PAR 38 = 108°C  
Mounting box included

**Recommended lamp**

LED E27 9W 240°  
3000K 810lm  
10kWh/1000h  
Item No. 1001031



LED E27 9W 240°  
4000K 850lm  
9kWh/1000h  
Item No. 1002827



**Lamp details**

11W max.  
Diameter: 4,5 cm max. L: 13,4 cm max.  
optional: LED PAR30 PAR38

Variant	Item No.
E27   TC(...)SE	
○ stainless steel	229200





229234 760



228370 760



229230 760



1002893 763



DASAR® 255  
EL



- Shade: stainless steel 316
- Asymmetrical reflector

Product details

220-240V ~50/60Hz 750mA  
Total wattage: 34W  
Material: stainless steel 316/aluminium/glass

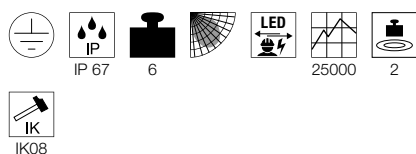

Dimensional drawing

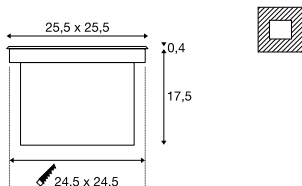

Tip

Mounting box included

DASAR® 270  
EL, asymmetrical



- Asymmetrical light distribution

Product details

220-240V ~50/60Hz | 700mA  
Total wattage: 30W  
Material: aluminium/stainless steel 316

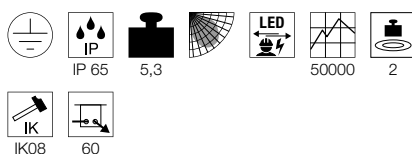

Dimensional drawing

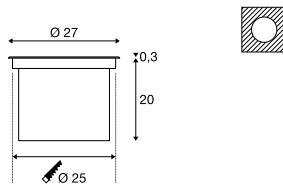

Tip

Mounting box included

DASAR® 270  
EL, symmetrical



- Symmetrical light distribution
- Pivoting light head

Product details

220-240V ~50/60Hz | 700mA  
Total wattage: 30W  
Material: aluminium/stainless steel 316

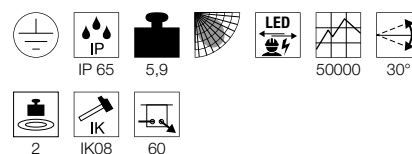

Dimensional drawing

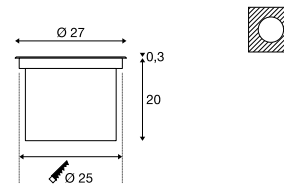

Tip

Mounting box included

Recommended accessories

- Glare protection  
Item No. 1002899

Variant	Item No.
1620lm   4000K   CRI>80 ■ stainless steel	229381
1620lm   3000K   CRI>80 ■ stainless steel	229383

Variant	Item No.
2000lm   3000K   CRI>80 ■ stainless steel	1002893
2100lm   4000K   CRI>80 ■ stainless steel	1002895

Variant	Item No.
250lm · 3000K · CRI>80 ■ stainless steel	1002897
2600lm · 4000K · CRI>80 ■ stainless steel	1002898

DASAR®  
EL, T16

SOCKET  
INSIDE

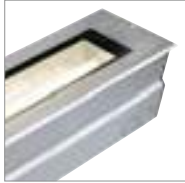

• Shade: stainless steel 316

Product details

230V -50Hz  
Total wattage: 13.6W  
Material: stainless steel 316/aluminium/glass

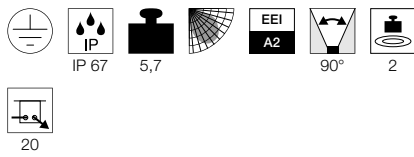

Dimensional drawing

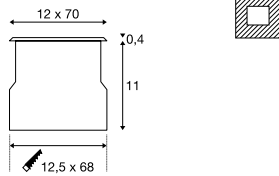

Tip

Mounting box included

Recommended lamp

G5 14W  
3000K 1200lm  
16kWh/1000h  
Item No. 548014 ▼

Lamp details

14W

Variant	Item No.
G5   T16	
■ stainless steel	230100

DASAR®  
EL, T16

SOCKET  
INSIDE

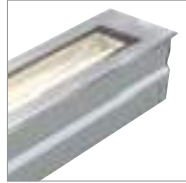

• Shade: stainless steel 316

Product details

230V -50Hz  
Total wattage: 23.3W  
Material: stainless steel 316/aluminium/glass

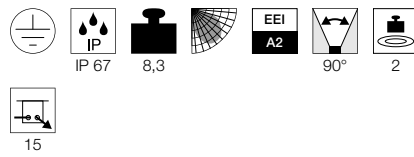

Dimensional drawing

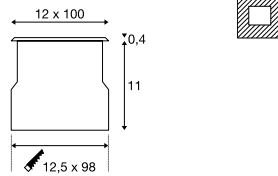

Tip

Mounting box included

Recommended lamp

G5 21W  
3000K 1900lm  
23kWh/1000h  
Item No. 548021 ▼

Lamp details

21W

Variant	Item No.
G5   T16	
■ stainless steel	230110



230100 764



230100 764



230100 764





230110 764

# LED PROFILE

## OVERVIEW



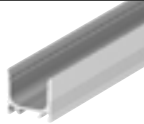
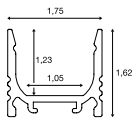
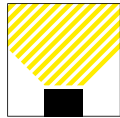

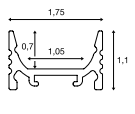
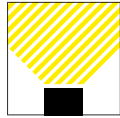
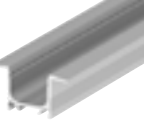
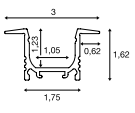
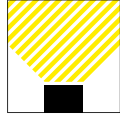
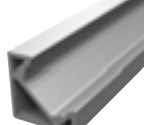
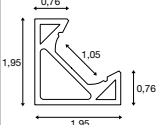
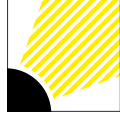
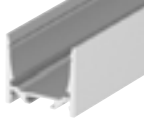
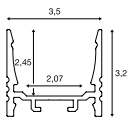
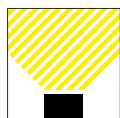
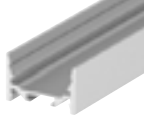
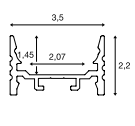
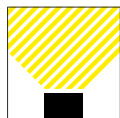
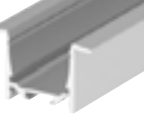
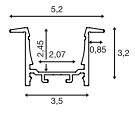
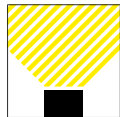
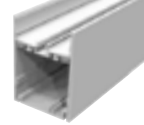
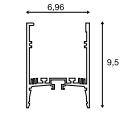
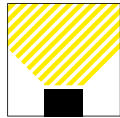
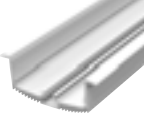
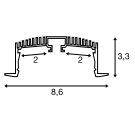
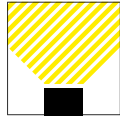
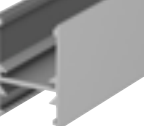
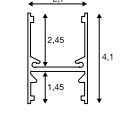
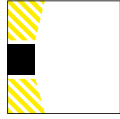
LED profile	Installation type			Cross-section	Beam angle	Page		
	Surface-mounted	Recessed	Pendant					
GRAZIA 10	Standard		✓	-	-			769
	Flat		✓	-	-			769
	Recessed		-	✓	-			769
GRAZIA 10 EDGE	Surface-mounted		✓	-	-			772
GRAZIA 20	Standard		✓	-	✓			775
	Flat		✓	-	✓			775
	Recessed		-	✓	-			776
GRAZIA 60	Surface-mounted		✓	-	-			781
	Recessed		-	✓	-			781
H-PROFIL			✓	-	✓			785



You can find suitable strips and components from page 788 and suitable accessories (mains adapters, drivers, etc.) from page 824

# GRAZIA 10

SURFACE-MOUNTED AND RECESSED PROFILE

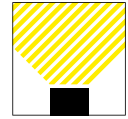



## SURFACE-MOUNTED PROFILE, STANDARD

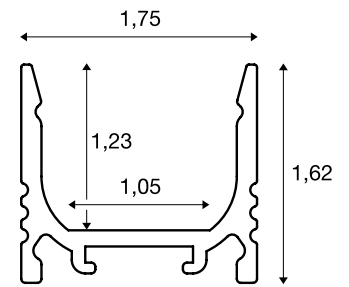
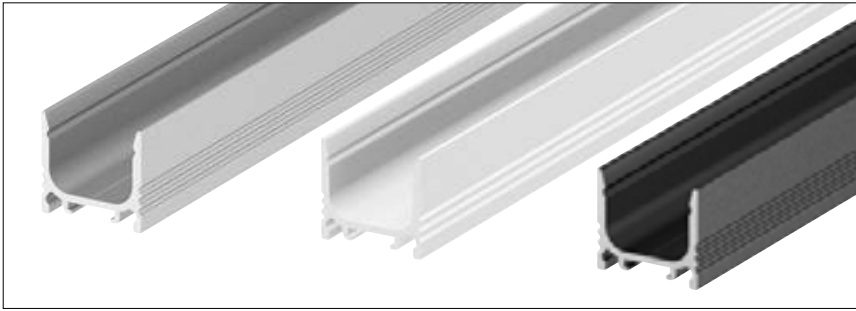

Surface-mounted, standard, aluminium, white, black

Length	Colour	Weight (kg)	Item No.
200 cm	aluminium	0,35	1000463
	white	0,46	1000464
	black	0,46	1000465

Material: aluminium, Width/height: 1.75/1.62 cm, max. width LED strip: 1.0 cm, cover not included

## SURFACE-MOUNTED PROFILE, FLAT

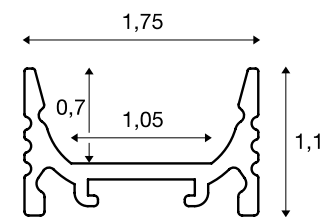

Surface-mounted, flat, aluminium, white, black

Length	Colour	Weight (kg)	Item No.
200 cm	aluminium	0,27	1000460
	white	0,36	1000461
	black	0,36	1000462

Material: aluminium, Width/height: 1.75/1.1 cm, max. width LED strip: 1.0 cm, cover not included

## RECESSED PROFILE

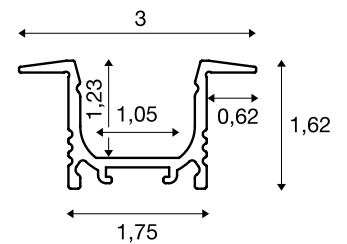

Recessed profile, anodised aluminium, white, black

Length	Colour	Weight (kg)	Item No.
200 cm	aluminium	0,42	1000457
	white	0,53	1000458
	black	0,53	1000459

Material: aluminium, Width/height: 3.0/1.62 cm, max. width LED strip: 1.0 cm, cover not included

# GRAZIA 10

## ACCESSORIES

### COVERS

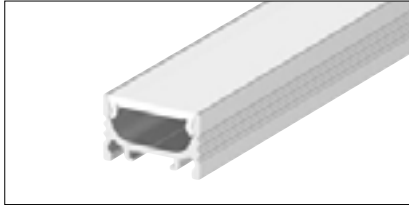

flat, opaque

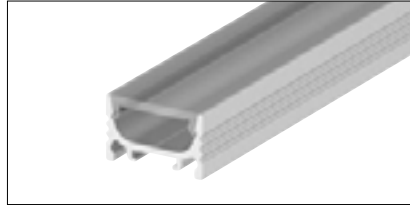

flat, transparent

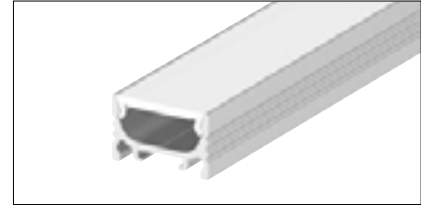

flat, transparent

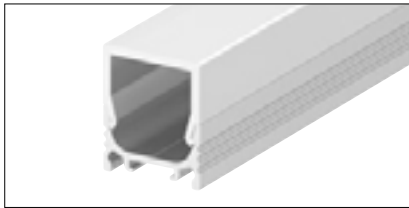
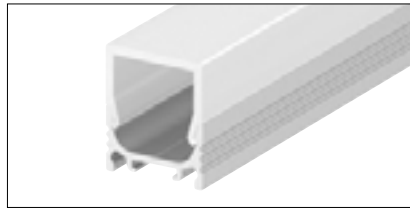
high, opaque  
(only suitable for surface-mounted profile)high, transparent  
(only suitable for surface-mounted profile)

Length	Colour	Material	Item No.
200 cm	flat, opaque	Plastic PC	1000466
	flat, opaque	Plastic PMMA	1000468
	flat, transparent	Plastic PC	1000467
	flat, transparent	Plastic PMMA	1000469
	high, opaque *	Plastic PC	1000470
	high, transparent *	Plastic PC	1000471

#### Plastic PMMA/PC:

Profile covers made of PMMA are especially uniform.

Profile covers made of PC are break-proof and especially suitable for use in contexts requiring high resilience.

\* The high covers are only suitable for GRAZIA 10 surface-mounted profiles, not for recessed profiles.

### MOUNTING CLIPS



Mounting clip, not visible

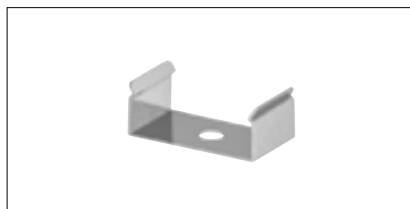

Mounting clip, visible



Mounting clip, 45°

Description	Dimensions	Item No.
Mounting clip, not visible	W/H/D: 1.53/0.3/1 cm	1000487
Mounting clip, visible	W/H/D: 1.87/0.7/1 cm	1000488
Mounting clip, 45°	W/H/D: 1.62/1.62/1 cm	1000489

Material: stainless steel, Packaging contents: 2 pieces

## END CAPS FOR SURFACE-MOUNTED PROFILE

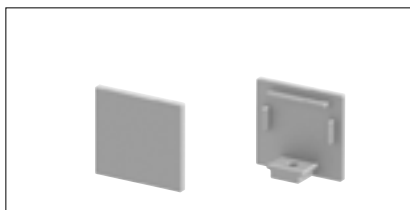

for standard profile, flat cover

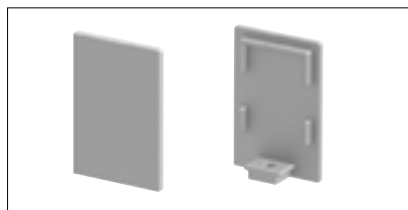

for standard profile, high cover

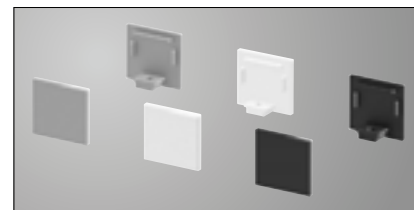

available colour variants

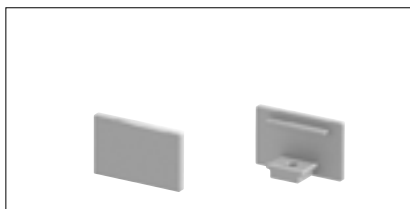

for flat profile, flat cover

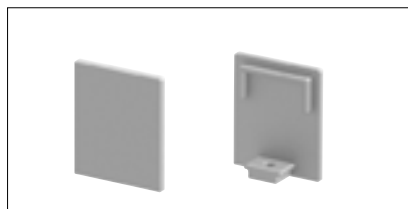

for flat profile, high cover

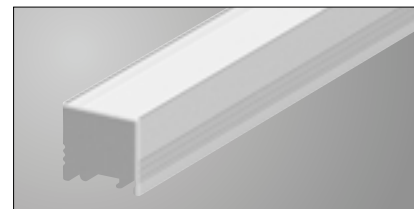

Profile with mounted end caps

Description	Colour	visible depth	Item No.
End caps for standard profile, flat cover	aluminium	0.2 cm	1000478
	white		1000479
	black		1000480
End caps for standard profile, high cover	aluminium	0.2 cm	1000484
	white		1000485
	black		1000486
End caps for flat profile, flat cover	aluminium	0.2 cm	1000475
	white		1000476
	black		1000477
End cap for flat profile, high cover	aluminium	0.2 cm	1000481
	white		1000482
	black		1000483

Material: aluminium, Packaging contents: 2 pieces

## END CAPS FOR RECESSED PROFILE

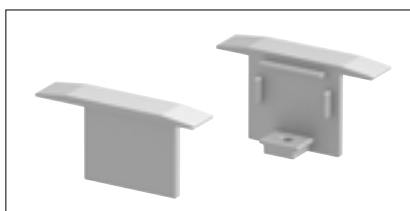

for recessed profile

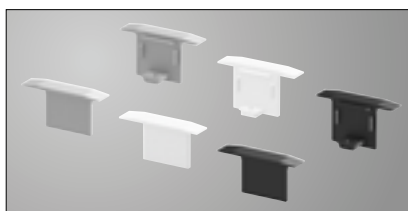

available colour variants

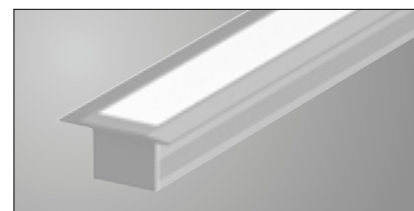

Profile with mounted end caps

Description	Colour	visible depth	Item No.
End cap for recessed profile	aluminium	0.7 cm	1000472
	white		1000473
	black		1000474

Material: aluminium, Packaging contents: 2 pieces



Please note that when using end caps, the visible depth must be subtracted from the profile length to obtain the desired overall length.

**visible depth of end caps + profile length = total length**

# GRAZIA 10 EDGE NEW

## SURFACE-MOUNTED PROFILES

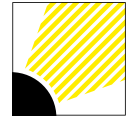

### SURFACE-MOUNTED PROFILES



Surface-mounted, aluminium, white

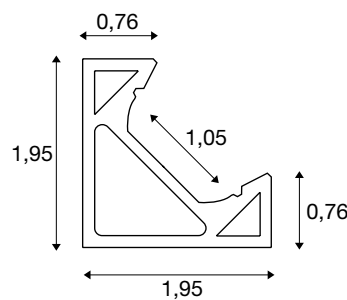

Length	Colour	Weight (kg)	Item No.
200 cm	aluminium	0,43	1004889 <span style="color: red; font-weight: bold;">NEW</span>
	white	0,43	1004890 <span style="color: red; font-weight: bold;">NEW</span>

Material: aluminium, Width/height: 1.95/1.95 cm, max. width LED strip: 1.0 cm

# GRAZIA 10 EDGE

## ACCESSORIES

### COVERS



white, plastic PC



transparent, plastic PC



white, plastic PMMA

Length	Colour	Material	Item No.
200 cm	white	Plastic PC	1000466
	transparent	Plastic PC	1000467
	white	Plastic PMMA	1000468
	transparent	Plastic PMMA	1000469

#### Plastic PMMA/PC:

Profile covers made of PMMA are especially uniform.

Profile covers made of PC are break-proof and especially suitable for use in contexts requiring high resilience.

### END CAPS

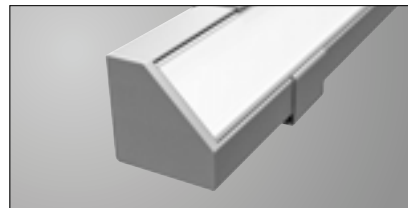
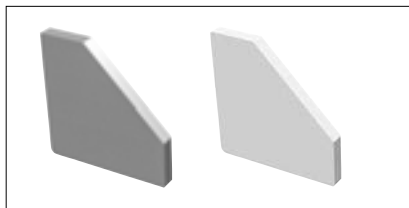

Description	Colour	visible depth	Item No.
End caps	aluminium	2 mm	1004893
	white	2 mm	1004894

Material: aluminium, Packaging contents: 2 pieces



Please note that when using end caps, the visible depth must be subtracted from the profile length to obtain the desired overall length.

**visible depth of end caps + profile length = total length**

### MOUNTING CLIPS

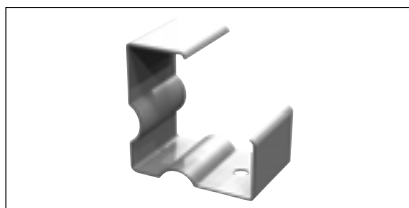

Description	Colour	Dimensions	Item No.
Mounting clips	stainless steel	L/B/H: 2.25/15/3.25 cm	1004895

Material: steel, Packaging contents: 4 pieces

# GRAZIA 20

## SURFACE-MOUNTED PROFILES

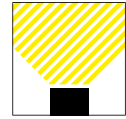

can also be used as a pendant light (pendant suspension p. 779)



high-quality powder-coated aluminium surface



available colour variants: aluminium, white, black

# GRAZIA 20

## SURFACE-MOUNTED PROFILES

### STANDARD

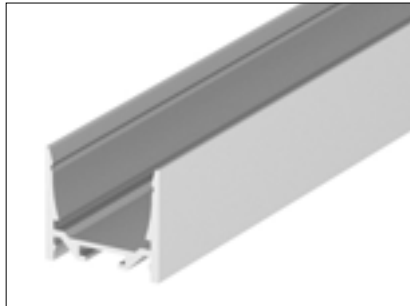

smooth

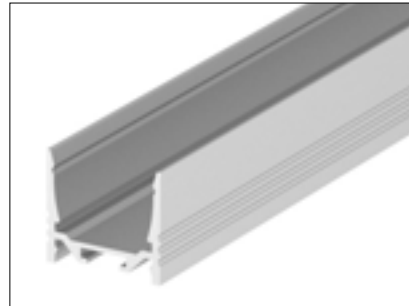

grooved

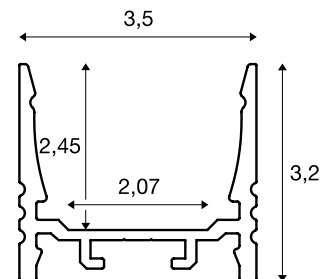

Description	Length	Colour	Weight (kg)	Item No.
Standard smooth	150 cm	aluminium	0,9	1004918
		white	0,9	1004919
		black	0,9	1004920
	300 cm	aluminium	2,49	1000523
		white	2,55	1000524
		black	2,55	1000525
Standard grooved	300 cm	aluminium	2,4	1000514
		white	2,46	1000515
		black	2,46	1000516

Material: aluminium, Width/height: 3.5/3.2 cm, max. width LED strip: 2.0 cm, cover not included

### FLAT

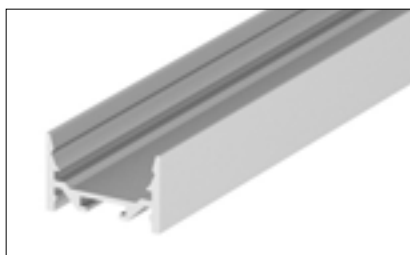

smooth



grooved

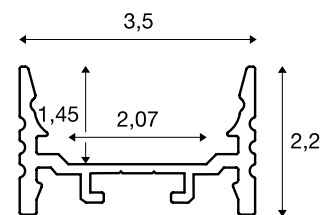

Description	Length	Colour	Weight (kg)	Item No.
Flat smooth	150 cm	aluminium	0,9	1004921
		white	0,9	1004922
		black	0,9	1004923
	300 cm	aluminium	1,56	1000532
		white	1,62	1000533
		black	1,62	1000534
Flat grooved	300 cm	aluminium	1,47	1000505
		white	1,53	1000506
		black	1,53	1000507

Material: aluminium, Width/height: 3.5/2.2 cm, max. width LED strip: 2.0 cm, cover not included

# GRAZIA 20

## RECESSED PROFILE

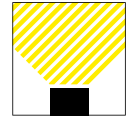

### RECESSED PROFILE

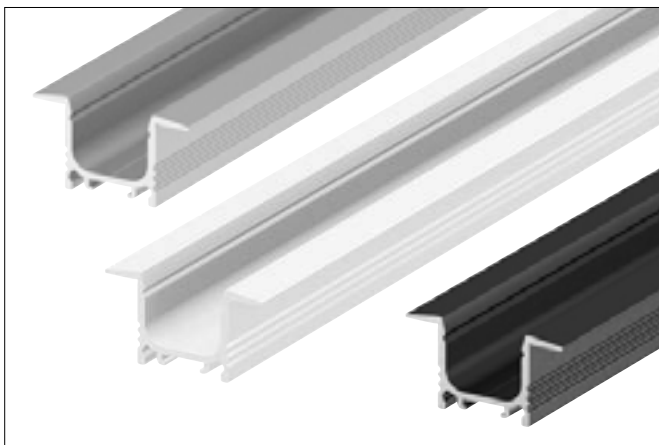

Recessed, aluminium, white, black

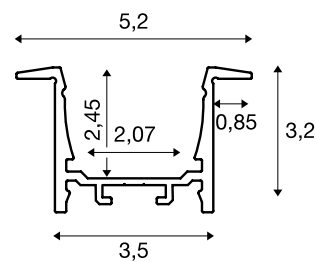

Length	Colour	Weight (kg)	Item No.
150 cm	aluminium	1,05	1004924
	white	1,05	1004925
	black	1,05	1004926
300 cm	aluminium	2,28	1000496
	white	2,34	1000497
	black	2,34	1000498

Material: aluminium, Width/height: 5.2/3.2 cm, max. width LED strip: 2.0 cm, cover not included



# GRAZIA 20

## ACCESSORIES

### COVERS

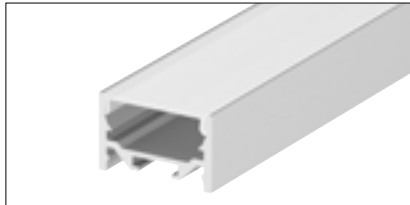

flat, transparent

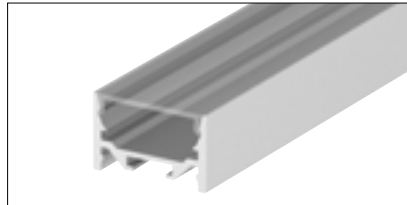

flat, transparent

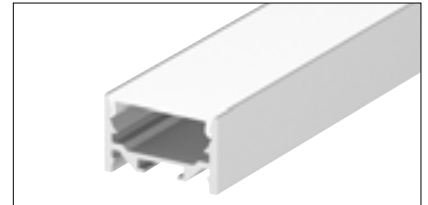

flat, opaque

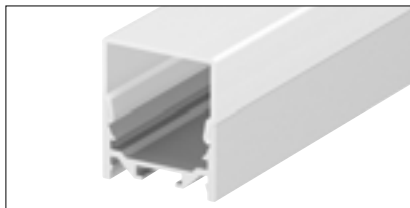

high, transparent

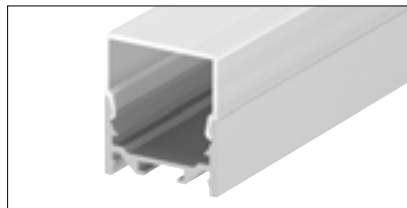

high, opaque

Length	Colour	Material	Item No.
150 cm	flat, frosted	Plastic PC	1004927
	flat, frosted	Plastic PMMA	1004928
	flat, opaque	Plastic PMMA	1004929
	high, frosted*	Plastic PC	1004930
	high, frosted*	Plastic PMMA	1004931
300 cm	flat, frosted	Plastic PC	1000540
	flat, frosted	Plastic PMMA	1000546
	flat, opaque	Plastic PMMA	1000549
	high, frosted*	Plastic PMMA	1000555
	high, frosted*	Plastic PC	1000552

#### Plastic PMMA/PC:

Profile covers made of PMMA are especially uniform.

Profile covers made of PC are break-proof and especially suitable for use in contexts requiring high resilience.

\* The high covers are only suitable for GRAZIA 20 surface-mounted profiles, not for recessed profiles.

### LONGITUDINAL CONNECTOR

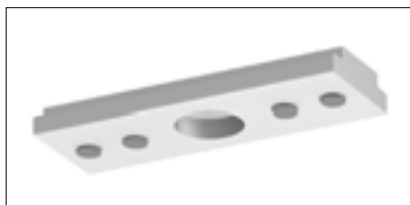

Description	Colour	Dimensions	Item No.
Longitudinal connector	aluminium	L/W/H: 3.8/1.4/0.4 cm	1000571

Material: aluminium, Packaging contents: 2 pieces

# GRAZIA 20

## ACCESSORIES

### END CAPS FOR SURFACE-MOUNTED PROFILE

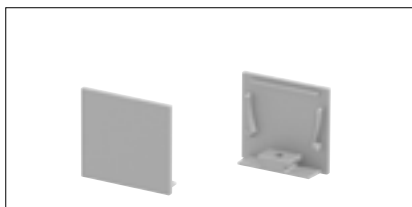

for standard profile, flat cover

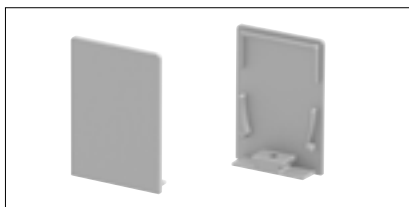

for standard profile, high cover

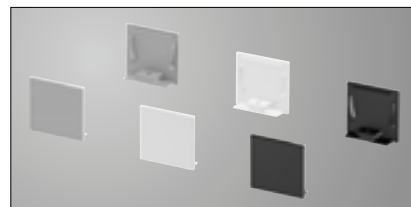

available colour variants

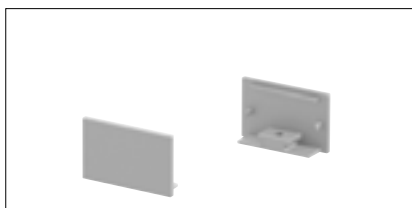

for flat profile, flat cover

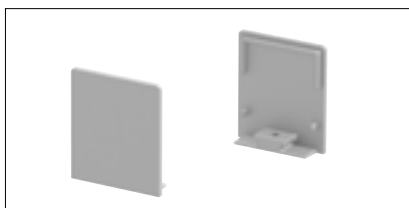

for flat profile, high cover

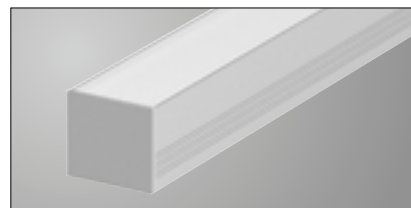

Profile with mounted end caps

Description	Colour	visible depth	Item No.
Standard profile, flat cover	aluminium	0.25 cm	1000565
	white		1000566
	black		1000567
Standard profile, high cover	aluminium	0.25 cm	1000568
	white		1000569
	black		1000570
Flat profile, flat cover	aluminium	0.25 cm	1000559
	white		1000560
	black		1000561
Flat profile, high cover	aluminium	0.25 cm	1000562
	white		1000563
	black		1000564

Material: aluminium, Packaging contents: 2 pieces

**i** Please note that when using end caps, the visible depth must be subtracted from the profile length to obtain the desired overall length.  
**visible depth of end caps + profile length = total length**

### END CAPS FOR RECESSED PROFILE

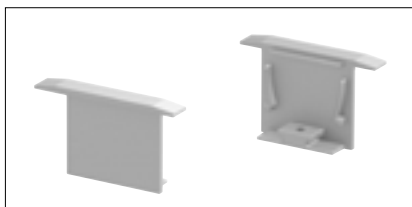

for recessed profile

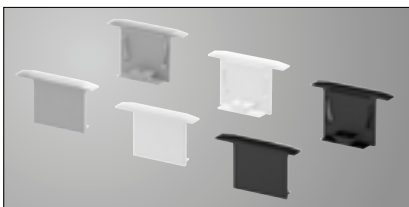

available colour variants

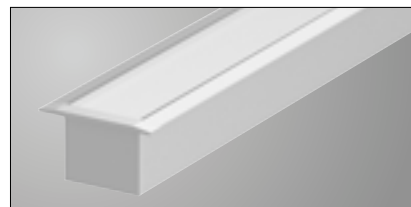

Profile with mounted end caps

Description	Colour	visible depth	Item No.
End cap for recessed profile	aluminium	0.085 cm	1000556
	white	0.085 cm	1000557
	black	0.085 cm	1000558

Material: aluminium, Packaging contents: 2 pieces

**i** Please note that when using end caps, the visible depth must be subtracted from the profile length to obtain the desired overall length.  
**visible depth of end caps + profile length = total length**

## PENDANT SUSPENSION FOR MOUNTING CLIPS



Pendant suspension  
(only for surface-mounted profile)



Mounting clip, not visible

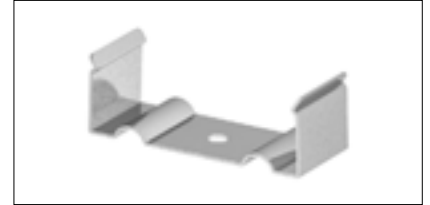

Mounting clip, visible  
(only for grooved surface-mounted profile)

Description	Dimensions	Item No.
Pendant suspension*	Pendant L: 200 cm	<b>1000535</b>
Mounting clip, not visible	L/W/H: 2.82/1.2/1.4 cm	<b>1000536</b>
Mounting clip, visible**	L/W/H: 3.65/6.2/1.5 cm	<b>1000537</b>

Material: stainless steel, Packaging contents: 2 pieces

\* The pendant suspension is only suitable for the surface-mounted profile.

\*\*The visible mounting clip is only suitable for the **GRAZIA 20 Standard, grooved** profile and the **GRAZIA 20 Flat, grooved** profile.



# GRAZIA 60 NEW

SURFACE-MOUNTED AND RECESSED PROFILE

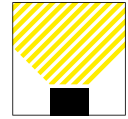

## SURFACE-MOUNTED PROFILE

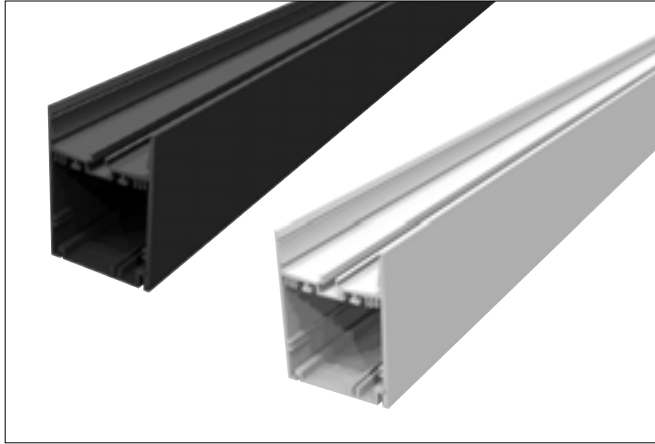

Surface-mounted profile, black, white

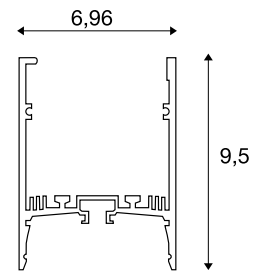

Length	Colour	Weight (kg)	Item No.
150 cm	black	3,36	1004896
	white	3,36	1004897
300 cm	black	6,72	1004898
	white	6,72	1004899

Material: aluminium, Width/height: 7/9.5 cm, max. width LED strip: 2.0 cm, cover not included

## RECESSED PROFILE

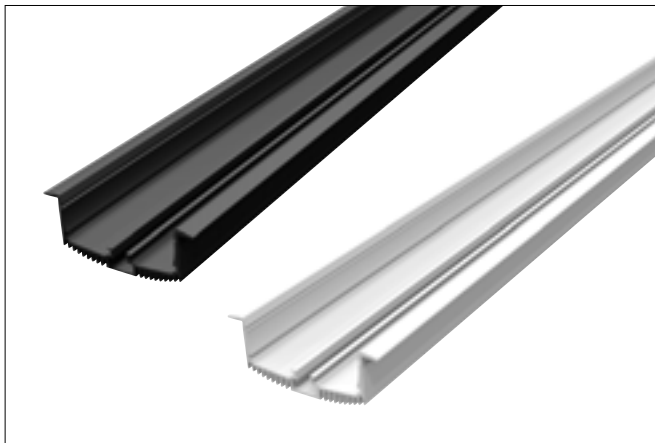

Recessed profile, black, white

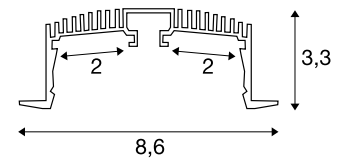

Length	Colour	Weight (kg)	Item No.
150 cm	black	1,55	1004905
	white	1,55	1004906
300 cm	black	6,72	1004907
	white	6,72	1004908

Material: aluminium, Width/height: 8.5/3.3 cm, max. width LED strip: 2.0 cm, cover not included

# GRAZIA 60 NEW

## ACCESSORIES

### COVERS



black, aluminium, 150 cm



white, aluminium, 150 cm



frosted, plastic PC, 150 cm



frosted, plastic PMMA, 150 cm



frosted, plastic PC, 300 cm



frosted, plastic PC, 300 cm

Length	Colour	Material	Item No.
150 cm	black	aluminium	<b>1004912</b> <span style="color: red;">NEW</span>
	white	aluminium	<b>1004913</b> <span style="color: red;">NEW</span>
	frosted	Plastic PC	<b>1004914</b> <span style="color: red;">NEW</span>
300 cm	frosted	Plastic PMMA	<b>1004916</b> <span style="color: red;">NEW</span>
	frosted	Plastic PC	<b>1004915</b> <span style="color: red;">NEW</span>
	frosted	Plastic PC	<b>1004917</b> <span style="color: red;">NEW</span>

#### Plastic PMMA/PC:

Profile covers made of PMMA are especially uniform.

Profile covers made of PC are break-proof and especially suitable for use in contexts requiring high resilience.

### END CAPS

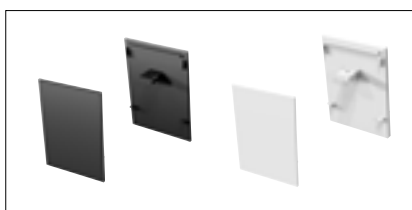

for surface-mounted profile

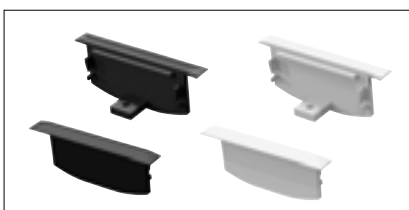

for recessed profile

Description	Colour	visible depth	Item No.
End cap for surface-mounted profile	black	0.085 cm	<b>1004900</b> <span style="color: red;">NEW</span>
	white	0.085 cm	<b>1004901</b> <span style="color: red;">NEW</span>
End cap for recessed profile	black	0.085 cm	<b>1004909</b> <span style="color: red;">NEW</span>
	white	0.085 cm	<b>1004910</b> <span style="color: red;">NEW</span>

Material: aluminium, Packaging contents: 2 pieces

**i** Please note that when using end caps, the visible depth must be subtracted from the profile length to obtain the desired overall length.  
**visible depth of end caps + profile length = total length**

# GRAZIA 60 NEW

## ACCESSORIES

### MOUNTING ACCESSORIES FOR SURFACE-MOUNTED PROFILE



Description	Colour	Dimensions	Item No.
Mounting accessories	aluminium	L/W/H: 150/7/9.5 cm	<b>1004902</b> <span style="color: red; font-weight: bold; border-radius: 50%; padding: 2px;">NEW</span>

Material: aluminium, Packaging contents: 1 piece

### LONGITUDINAL CONNECTOR

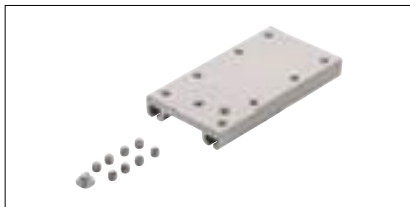

Description	Colour	Dimensions	Item No.
Longitudinal connector	aluminium	L/W/H: 8/4.2/1 cm	<b>1004903</b> <span style="color: red; font-weight: bold; border-radius: 50%; padding: 2px;">NEW</span>

Material: aluminium, Packaging contents: 2 pieces

### FEED-IN

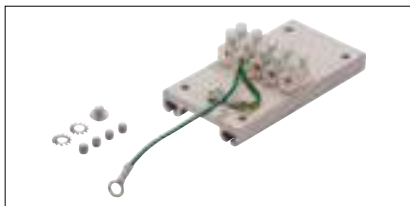

Description	Colour	Dimensions	Item No.
Feed-in	aluminium	L/W/H: 8/4.2/2.4 cm	<b>1004904</b> <span style="color: red; font-weight: bold; border-radius: 50%; padding: 2px;">NEW</span>

Material: aluminium, Packaging contents: 1 piece

### MOUNTING CLIP FOR RECESSED PROFILE

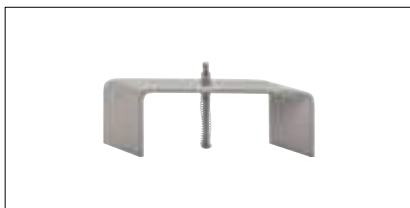

Description	Colour	Dimensions	Item No.
Mounting clip	chrome	L/W/H: 13/17/4 cm	<b>1004911</b> <span style="color: red; font-weight: bold; border-radius: 50%; padding: 2px;">NEW</span>

Material: steel, Packaging contents: 2 pieces

# H-PROFIL

2m

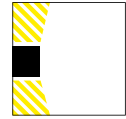





## H-PROFIL 2m

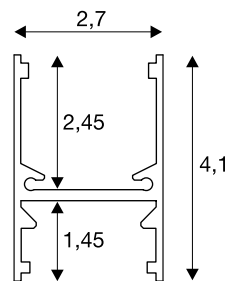
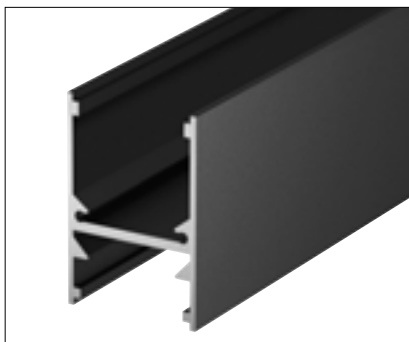

Length	Colour	Weight (kg)	Item No.
200 cm	black	1	1001814
	white		1001816
	aluminium		1001817

Material: aluminium, Width/height: 2.7/4.1 cm, max. width LED strip: 1.6 cm, cover not included

# H-PROFIL

## 2m – ACCESSORIES

### COVER

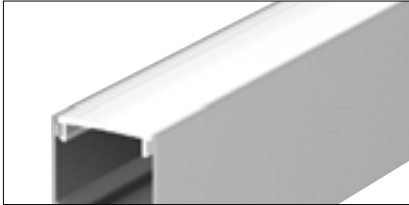

Cover, opaque

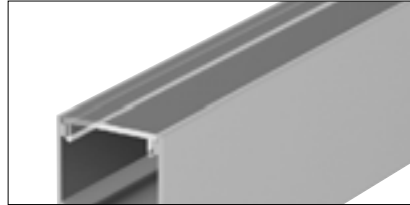

Cover, transparent

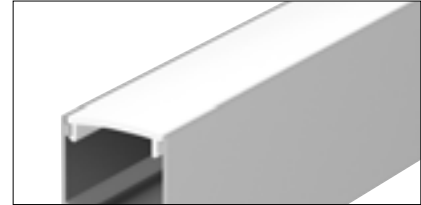

Cover, satin-finish

Length	Colour	Material	Item No.
200 cm	opaque	Plastic PC	<b>1001813</b>
	transparent	Plastic PC	<b>1001815</b>
	transparent	Plastic PMMA	<b>214350</b>
	transparent	Plastic PMMA	<b>214351</b>

Packaging contents: 1 piece

### END CAPS

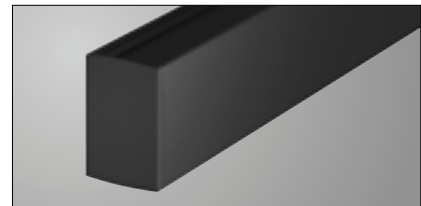

Description	Colour	visible depth	Item No.
End caps	black	0.14 cm	<b>1001807</b>
	white	0.14 cm	<b>1001808</b>
	grey	0.14 cm	<b>1001809</b>

Material: aluminium, Packaging contents: 2 pieces

**i** Please note that when using end caps, the visible depth must be subtracted from the profile length to obtain the desired overall length.  
**visible depth of end caps + profile length = total length**

### CONNECTOR

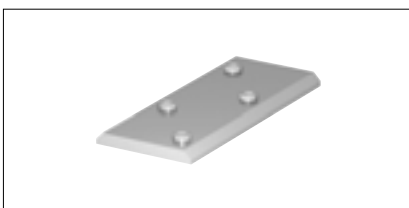

Description	Colour	Dimensions	Item No.
Connector	grey	L/W/H: 5.6/2.4/0.3 cm	<b>1001806</b>

Material: aluminium

## MOUNTING ACCESSORIES

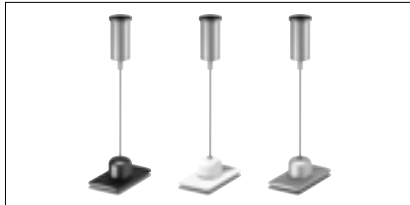

Pendant suspension

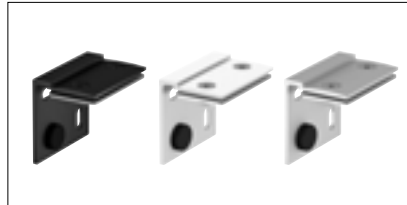

Wall bracket



Adapter for track

Description	Colour	Material	Dimensions	Item No.
Pendant suspension, 2 pieces	black	Aluminium/steel	L/W/H: 4.4/2.4/2 cm Pendant L: 200 cm	1001796
	white			1001797
	aluminium			1001798
Wall bracket, 2 pieces	black	Aluminium/plastic	L/W/H: 4.4/3.2/4 cm	1001802
	white			1002236
	aluminium			1002237

## STRAIN RELIEF



Description	Colour	Dimensions	Item No.
Strain relief	black	L/W/H: 4.4/2.4/2.6 cm	1001799
	white		1001800
	aluminium		1001801

Material: aluminium/steel, Cable diameter max. 6.5 mm, Packaging contents: 1 piece

## CONNECTION BOX



Description	Colour	Dimensions	Item No.
Connection box	black	L/W/H: 37.6/6.6/4.7 cm	1001803
	white		1001804
	grey		1001805

Material: aluminium/steel, The ceiling rose is prepared for the installation of control devices and cables. Control devices and cables are available separately. Available installation space for driver max. 6.2 x 25 x 4 cm. Packaging contents: 1 piece

# IMPRESSIVE LINE-UP.

## LED STRIP LIGHTS AND LIGHT BARS FOR A SPECIAL ATMOSPHERE.

---

Want to introduce a bit of variety? LED strip lights and light bars are modern and extraordinary design elements giving rooms a special atmosphere. The elongated luminaires with many different colours make a good impression as signposts.





1004727    799

# WHICH LED STRIP DO I NEED?

LED strips and profiles for your project.  
Everything at a glance.

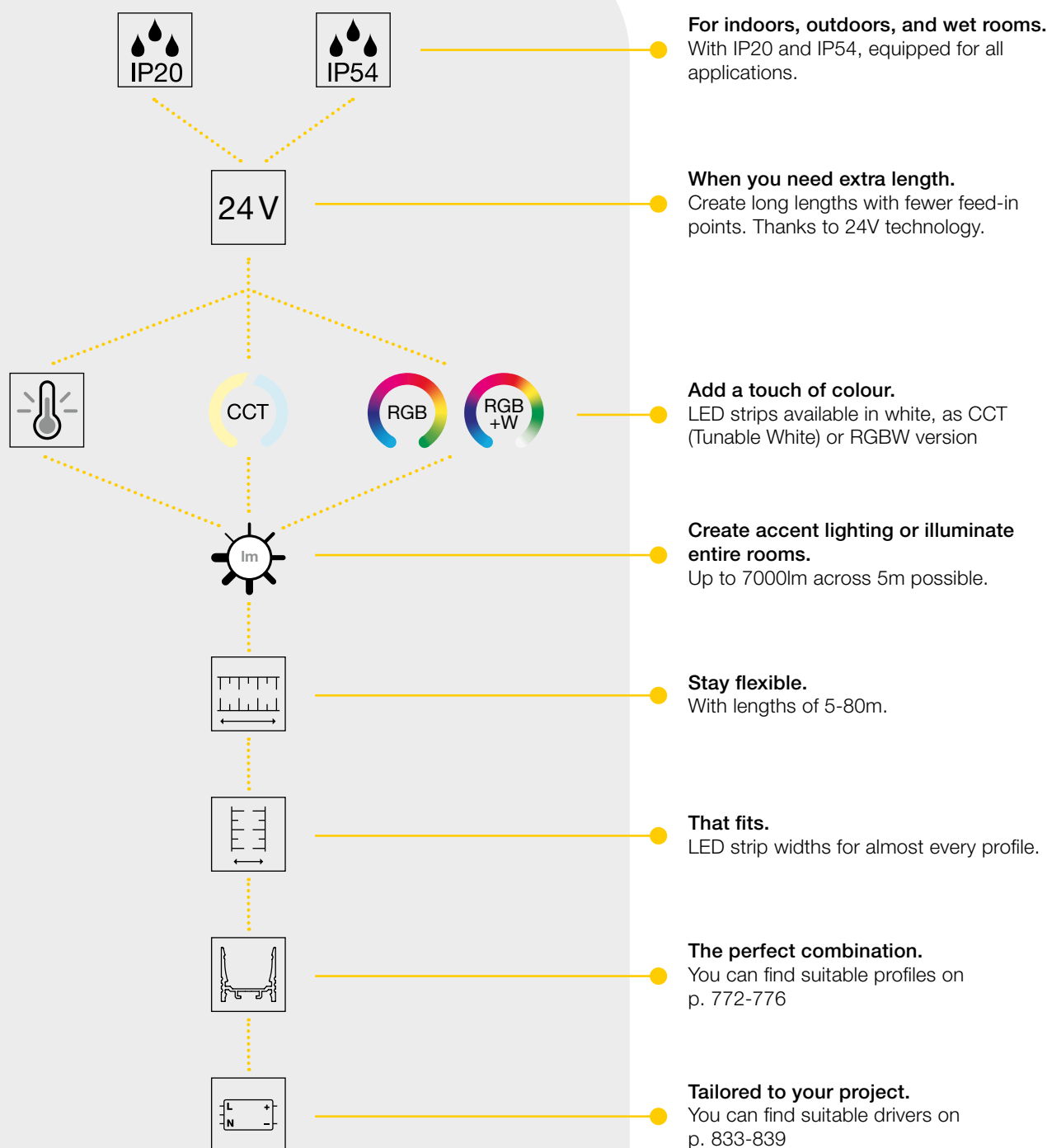

									LED strips	Profile
20	✓	2200-4000K	-	-	17600-21600lm	80 m	1 cm		GRAZIA FLEXSTRIP LED, 24V p. 792	GRAZIA 10 p. 769 GRAZIA 10 EDGE from p. 772
20	✓	2700-4000K	-	-	3500-3750lm	5 m	1 cm		GRAZIA FLEXSTRIP LED, 24V p. 793	GRAZIA 10 p. 769 GRAZIA 10 EDGE from p. 772
20	✓	2700-4000K	-	-	6500-7000lm	5 m	1 cm		GRAZIA PRO FLEXSTRIP, 24V p. 794	GRAZIA 10 p. 769 GRAZIA 10 EDGE from p. 772
20	✓	2700-6500K	-	-	8500-9100K	5 m	1 cm		GRAZIA PRO FLEXSTRIP, 24V p. 795	GRAZIA 10 p. 769 GRAZIA 10 EDGE from p. 772
20	✓	3000-4000K	-	-	12500-13000lm	5 m	2 cm		GRAZIA PRO MAX FLEXSTRIP, 24V p. 796	GRAZIA 20 surface-mounted p. 775 GRAZIA 20 Recessed p. 776
20	✓	3000-4000K	-	-	20000-21400lm	5 m	2 cm		GRAZIA PRO MAX FLEXSTRIP, 24V p. 797	GRAZIA 20 surface-mounted p. 775 GRAZIA 20 Recessed p. 776
20	✓	2700-6500K	✓	-	3400-3700lm	5 m	1 cm		GRAZIA PRO FLEXSTRIP, Tunable white, 24V p. 798	GRAZIA 10 p. 769 GRAZIA 10 EDGE from p. 772
20	✓	3000K	-	✓	2050-2500lm	5 m	2 cm		GRAZIA PRO FLEXSTRIP, RGBW, 24V p. 799	GRAZIA 20 surface-mounted p. 775 GRAZIA 20 Recessed p. 776
54	✓	2700-4000K	-	-	3350-3600lm	5 m	2 cm		GRAZIA IP FLEXSTRIP, 24V p. 800	GRAZIA 20 surface-mounted p. 775 GRAZIA 20 Recessed p. 776
54	✓	2700-6500K	-	-	3210-3500lm	5 m	2 cm		GRAZIA IP FLEXSTRIP, Tunable white, 24V p. 801	GRAZIA 20 surface-mounted p. 775 GRAZIA 20 Recessed p. 776
54	✓	3000K	-	✓	1940-2350lm	5 m	2 cm		GRAZIA IP FLEXSTRIP, RGBW, 24V p. 802	GRAZIA 20 surface-mounted p. 775 GRAZIA 20 Recessed p. 776

# GRAZIA FLEXSTRIP LED

## 24V



### GRAZIA FLEXSTRIP LED, 24V



48 LEDs pro m  
 Width/Height: 1/0.12 cm  
 LED gap: 1.7 cm  
 Can be separated every 10 cm  
 minimum bending radius: 3 cm

80 m, CRI>90

Colour temperature	Luminous flux (lm)	Wattage (W)	Colour rendering index (CRI)	Colour consistency	Length (cm)	Item No.
2200K	17600	211,2	>90	4SDCM	8000	1002996
2700K	19200					1002997
3000K	19200					1002998
4000K	21600					1002999

In order to obtain a consistent light output from a length of 30 m, we recommend feeding the strips on both sides.  
 With single-sided feed-in, a new feed-in must be provided from a length of 40 m.



Extra-long strip 80 m



To ensure heat dissipation, the LED strips must be glued into an aluminium profile.  
 Reverse of the LED strip with adhesive tape.



# GRAZIA FLEXSTRIP LED NEW

## 24V



### GRAZIA FLEXSTRIP LED, 24V



70 LEDs pro m  
 Width/Height: 1/0.12 cm  
 LED gap: 1.4 cm  
 Can be separated every 10 cm  
 minimum bending radius: 3 cm

5 m, CRI>90

Colour temperature	Luminous flux (lm)	Wattage (W)	Colour rendering index (CRI)	Colour consistency	Length (cm)	Item No.
2700K	3500	44	>90	3SDCM	500	1004708
3000K	3500					1004709
4000K	3750					1004710

In order to obtain a consistent light output from a length of 3 m, we recommend feeding the strips on both sides.  
 From a length of 5 m, a new feed-in must be provided.

To ensure heat dissipation, the LED strips must be glued into an aluminium profile.  
 Reverse of the LED strip with adhesive tape.

# GRAZIA PRO FLEXSTRIP NEW

## 24V



### GRAZIA PRO FLEXSTRIP, 24V



**126 LED pro m**  
**Width/Height: 1/0.12 cm**  
**LED gap: 0.8 cm**  
**Can be separated every 5.6 cm**  
**minimum bending radius: 3 cm**

5 m, CRI>90

Colour temperature	Luminous flux (lm)	Wattage (W)	Colour rendering index (CRI)	Colour consistency	Length (cm)	Item No.
2700K	6500	73	>90	3SDCM	500	1004712 <span style="color: red; font-weight: bold;">NEW</span>
3000K	6500					1004713 <span style="color: red; font-weight: bold;">NEW</span>
4000K	7000					1004714 <span style="color: red; font-weight: bold;">NEW</span>

In order to obtain a consistent light output from a length of 3 m, we recommend feeding the strips on both sides.  
 From a length of 5 m, a new feed-in must be provided.



To ensure heat dissipation, the LED strips must be glued into an aluminium profile.  
 Reverse of the LED strip with adhesive tape.

# GRAZIA PRO FLEXSTRIP

## 24V



### GRAZIA PRO FLEXSTRIP, 24V



**168 LEDs pro m**  
**Width/Height: 1/0.12 cm**  
**LED gap: 0.6 cm**  
**Can be separated every 4.2 cm**  
**minimum bending radius: 3 cm**

5 m, CRI>90

Colour temperature	Luminous flux (lm)	Wattage (W)	Colour rendering index (CRI)	Colour consistency	Length (cm)	Item No.
2700K	8500	91	>90	3SDCM	500	1004716
3000K	8500					1004717
4000K	9100					1004718
6500K	9100					1004719

In order to obtain a consistent light output from a length of 3 m, we recommend feeding the strips on both sides. From a length of 5 m, a new feed-in must be provided.



To ensure heat dissipation, the LED strips must be glued into an aluminium profile. Reverse of the LED strip with adhesive tape.

# GRAZIA PRO MAX FLEXSTRIP NEW

## 24V



### GRAZIA PRO MAX FLEXSTRIP, 24V

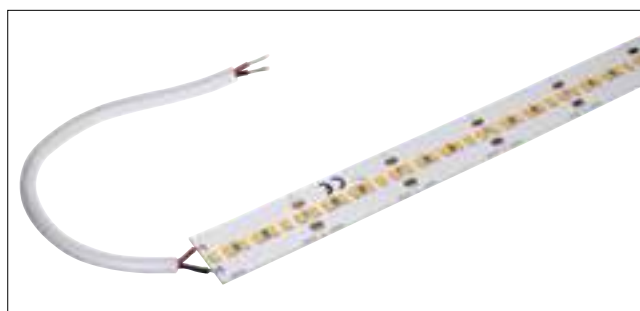

**196 LED pro m**  
**Width/Height: 2/0.15 cm**  
**LED gap: 0.5 cm**  
**Can be separated every 3.6 cm**  
**minimum bending radius: 3 cm**

5 m, CRI>90

Colour temperature	Luminous flux (lm)	Wattage (W)	Colour rendering index (CRI)	Colour consistency	Length (cm)	Item No.
3000K	12500	126	>90	3SDCM	500	1004720 <span style="color: red; font-weight: bold;">NEW</span>
4000K	13000					1004721 <span style="color: red; font-weight: bold;">NEW</span>

In order to obtain a consistent light output from a length of 3 m, we recommend feeding the strips on both sides.  
 From a length of 5 m, a new feed-in must be provided.



To ensure heat dissipation, the LED strips must be glued into an aluminium profile.  
 Reverse of the LED strip with adhesive tape.

# GRAZIA PRO MAX FLEXSTRIP

## 24V



### GRAZIA PRO MAX FLEXSTRIP, 24V

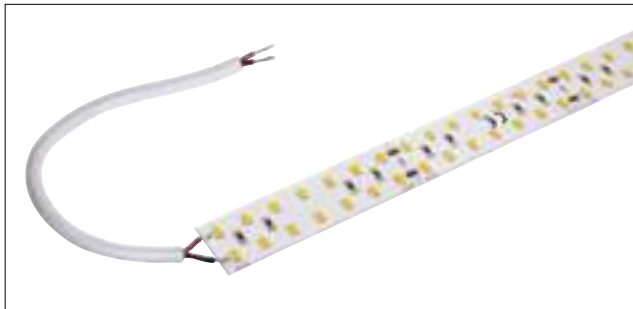

196 LEDs pro m  
 Width/Height: 2/0.15 cm  
 LED gap: 1 cm  
 Can be separated every 7.1 cm  
 minimum bending radius: 3 cm

5 m, CRI>90

Colour temperature	Luminous flux (lm)	Wattage (W)	Colour rendering index (CRI)	Colour consistency	Length (cm)	Item No.
3000K	20000	193	>90	3SDCM	500	1004722
4000K	21400					1004723

In order to obtain a consistent light output from a length of 3 m, we recommend feeding the strips on both sides.  
 From a length of 5 m, a new feed-in must be provided.

To ensure heat dissipation, the LED strips must be glued into an aluminium profile.  
 Reverse of the LED strip with adhesive tape.

# GRAZIA PRO FLEXSTRIP

NEW

TUNABLE WHITE, 24V



## GRAZIA PRO FLEXSTRIP, TUNABLE WHITE, 24V



224 LEDs pro m  
 Width/Height: 1/0.1 cm  
 LED gap: 0.9 cm  
 Can be separated every 6.3 cm  
 minimum bending radius: 3 cm

5 m, CRI>90

Colour temperature	Luminous flux (lm)	Wattage (W)	Colour rendering index (CRI)	Colour consistency	Length (cm)	Item No.
2700-6500K	3400-3700	80	>90	6SDCM	500	1004725

In order to obtain a consistent light output from a length of 3 m, we recommend feeding the strips on both sides.  
 From a length of 5 m, a new feed-in must be provided.



To ensure heat dissipation, the LED strips must be glued into an aluminium profile.  
 Reverse of the LED strip with adhesive tape.

# GRAZIA PRO FLEXSTRIP

NEW

RGBW, 24V



## GRAZIA PRO FLEXSTRIP, RGBW, 24V



70 LEDs pro m  
 Width/Height: 1.2/0.22 cm  
 LED gap: 1.4 cm  
 Can be separated every 10 cm  
 minimum bending radius: 3 cm

5 m, CRI>90

Colour temperature	Luminous flux (lm)	Wattage (W)	Colour rendering index (CRI)	Colour consistency	Length (cm)	Item No.
RGB	2500	60				
W   3000K	2050	27	>90	6SDCM	500	1004727

In order to obtain a consistent light output from a length of 3 m, we recommend feeding the strips on both sides.  
 From a length of 5 m, a new feed-in must be provided.

To ensure heat dissipation, the LED strips must be glued into an aluminium profile.  
 Reverse of the LED strip with adhesive tape.

# GRAZIA IP FLEXSTRIP

NEW

24V



## GRAZIA IP FLEXSTRIP, 24V



70 LEDs pro m  
 Width/Height: 1.2/0.4 cm  
 LED gap: 1.4 cm  
 Can be separated every 10 cm  
 minimum bending radius: 3 cm  
 IP54

5 m, CRI&gt;90

Colour temperature	Luminous flux (lm)	Wattage (W)	Colour rendering index (CRI)	Colour consistency	Length (cm)	Item No.
2700K	3350	44	>90	4SDCM	500	1004734
3000K	3350					1004735
4000K	3600					1004736

inc. 2 end caps and fittings

In order to obtain a consistent light output from a length of 3 m, we recommend feeding the strips on both sides.  
 From a length of 5 m, a new feed-in must be provided.



To ensure heat dissipation, the LED strips must be glued into an aluminium profile.  
 Reverse of the LED strip with adhesive tape.



# GRAZIA IP FLEXSTRIP

TUNABLE WHITE, 24V

NEW



## GRAZIA IP FLEXSTRIP, TUNABLE WHITE, 24V



224 LEDs pro m  
 Width/Height: 1.2/0.4 cm  
 LED gap: 0.9 cm  
 Can be separated every 6.3 cm  
 minimum bending radius: 3 cm  
 IP54

5 m, CRI>90

Colour temperature	Luminous flux (lm)	Wattage (W)	Colour rendering index (CRI)	Colour consistency	Length (cm)	Item No.
2700-6500K	3210-3500	80	>90	4SDCM	500	1004726

inc. 2 end caps and fittings

In order to obtain a consistent light output from a length of 3 m, we recommend feeding the strips on both sides.  
 From a length of 5 m, a new feed-in must be provided.

To ensure heat dissipation, the LED strips must be glued into an aluminium profile.  
 Reverse of the LED strip with adhesive tape.

# GRAZIA IP FLEXSTRIP

NEW

## RGBW, 24V



### GRAZIA IP FLEXSTRIP, RGBW, 24V



70 LEDs pro m  
 Width/Height: 1.4/0.46 cm  
 LED gap: 1.4 cm  
 Can be separated every 10 cm  
 minimum bending radius: 3 cm  
 IP54

5 m, CRI>90

Colour temperature	Luminous flux (lm)	Wattage (W)	Colour rendering index (CRI)	Colour consistency	Length (cm)	Item No.
RGB	2350	60				
W   3000K	1940	27	>90	6SDCM	500	1004737

inc. 2 end caps and fittings

In order to obtain a consistent light output from a length of 3 m, we recommend feeding the strips on both sides.  
 From a length of 5 m, a new feed-in must be provided.



To ensure heat dissipation, the LED strips must be glued into an aluminium profile.  
 Reverse of the LED strip with adhesive tape.



# BATTEN LED

220-240V ~50/60HZ



## BATTEN LED 220-240V ~50/60Hz

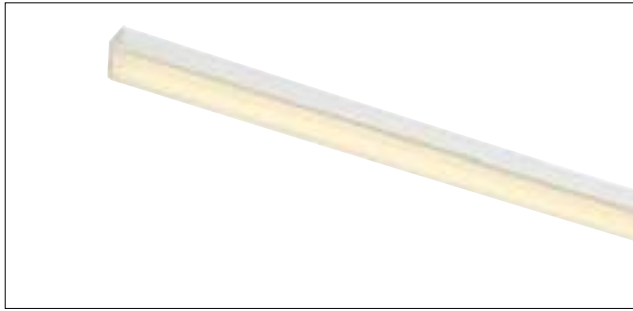

**220-240V ~50/60Hz 67V DC**  
**Width/height: 2.5/3.5cm**  
**Material: plastic PC**  
**Protection class: II**  
**Ambient temperature: -20°C bis 40°C**  
**Half beam angle 155°**

**Can be extended without the use of tools**

matt white

Colour temperature	Luminous flux (lm)	Wattage (W)	Colour rendering index (CRI)	Length (cm)	Weight (kg)	Item No.
3000K	735	8,1	>80	57,5	0,17	<b>631313</b>
	1065	12,4		87,5	0,23	<b>631315</b>
	1470	16,5		117,5	0,29	<b>631317</b>
4000K	855	8,1		57,5	0,17	<b>631323</b>
	1235	12,4		87,5	0,23	<b>631325</b>
	1710	16,5		117,5	0,28	<b>631327</b>

## ACCESSORIES BATTEN LED 220-240V ~50/60Hz

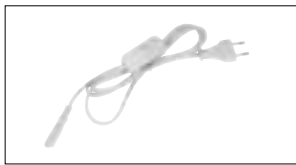

Feed-in cable with switch,  
1,5 m cable



Feed-in cable, 1,5 m cable



Connection cable, 15 cm cable

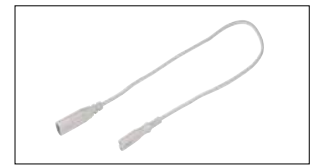

Connection cable, 15 cm cable



Mounting brackets 45°



Connector

Variant	Max. current load	Material	Length (cm)	Width (cm)	Height (cm)	Item No.
<input type="checkbox"/> Feed-in cable with switch, 1 piece	2A	Plastic	150	-	-	<b>631300</b>
<input type="checkbox"/> Feed-in cable, 1 piece	2A	Plastic	150	-	-	<b>631301</b>
<input type="checkbox"/> Connection cable, 1 piece	2A	Plastic	15	-	-	<b>631302</b>
<input type="checkbox"/> Connection cable, 1 piece	2A	Plastic	50	-	-	<b>631303</b>
<input checked="" type="checkbox"/> Mounting brackets 45°, 3 piece	-	Steel	2,5	1,3	1,2	<b>631304</b>
<input type="checkbox"/> Connector, 1 piece	2A	Plastic	2,2	2	1,1	<b>631305</b>





# DISCOVER DALI AND NETWORK LIGHTING.

Familiarise yourself with the protocol that makes it possible to easily install, manage and communicate with individual lights and lighting installations.

Already familiar with the terms smart home or smart building? Do you want to install flexible lighting scenarios and sequences? Unveiling DALI and suitable SLV products: the Digital Adressable Lighting Interface (DALI) simplifies digital communication between electronic ballasts, transformers and corresponding actuators: flexible light management for modern buildings combined with typical SLV light diversity.

- Flexible and intelligent light management.
- Centrally controlled with other building systems.
- Easy to install, universal use.

## **The basis for intelligent lighting.**

DALI – an excellent basis for flexible and intelligent light management in modern buildings. With DALI 2.0, it is now also possible to integrate sensors into the network. These can independently access the bus, communicate with a master controller, lighting controllers or other sensor controls and control the lights.

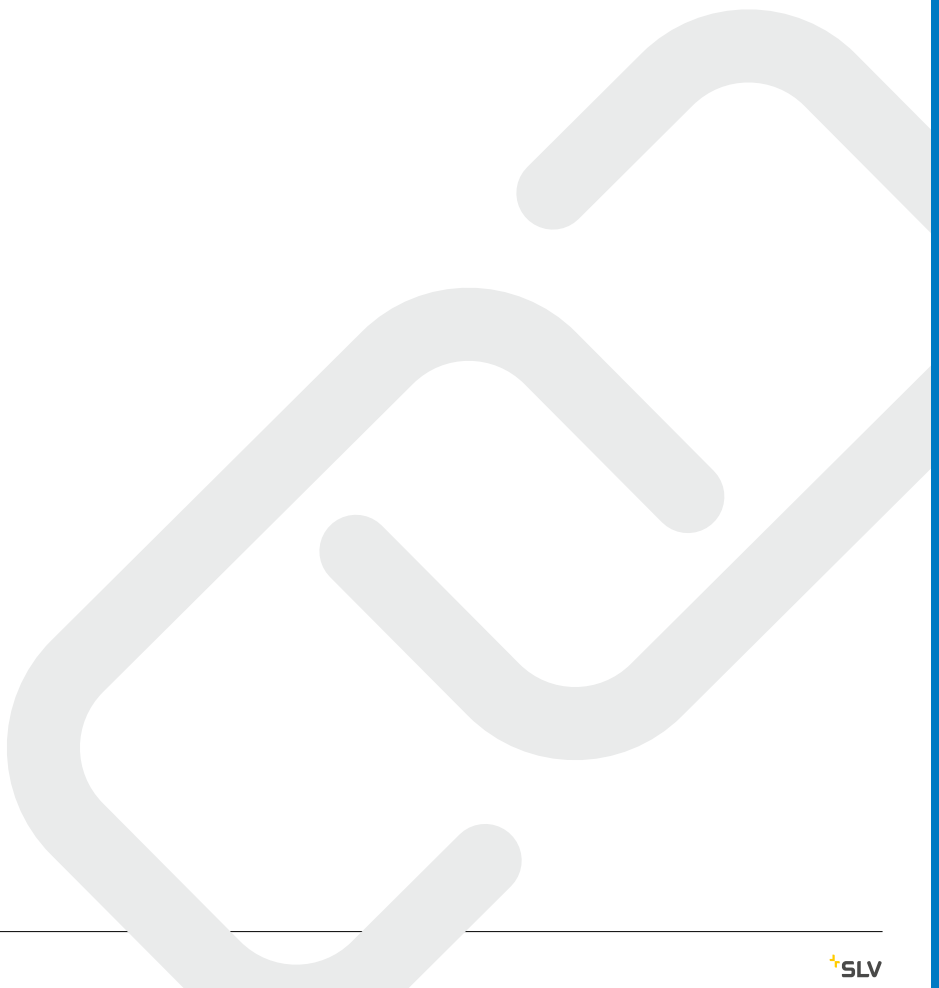

# SAFELY COMBINABLE: SLV, DALI AND SCHNEIDER ELECTRIC PRODUCTS.











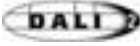

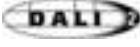

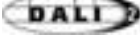

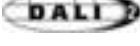

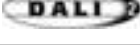
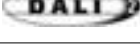



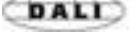

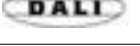

Working in close collaboration with Schneider Electric, we offer a tailored and easily installable solution. You benefit from SLV DALI lights, which largely already support DALI 2.0. Extensive testing guarantees compatibility between the KNX DALI Gateway of Schneider Electric and SLV DALI products.

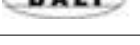
This means you can easily and seamlessly integrate all SLV DALI lights into a streamlined building management system via the Schneider Electric Gateway. The newly introduced NUMINOS lighting system along with our MEDO family offer an excellent choice of combinations and applications. Discover more about SLV lighting that can be networked with DALI on the following pages.

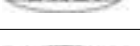
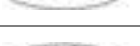

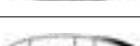



Lights	Page	DALI Version	Compatible with Schneider Electric KNX/Dali Gateway
NUMINOS, 3-circuit	42-47		
NUMINOS CW	48-53		
NUMINOS CL	54-59		
NUMINOS PD	60-65		
ONE 60/80/TRIPLE PD	157		
ONE 60/80/DOUBLE PD UP/DOWN	158-159		
ONE 40 WL	194		
ONE 40 TRACK	473		
WORKLIGHT PD DALI	176		
MEDO 30/40/60/90 AMBIENT CW	150-151, 300	 	 
MEDO 60 CL, square	153		
MEDO RING 60 PD	155		
MEDO 90 AMBIENT CL	301		
STRUCTEC 3-circuit	470		
FERA 25 CL	289		
I-PENDANT PRO PD	163		
LIPSY® 40/50 CW Drum	359		
PANEL 60 CL round	161		
PANEL CL 1200x300mm	305		
PANEL 60 PD round	161		
PARA FLAC PD/CL	185		
Q-LINE® PD single	169		
SIGHT TRACK 3-circuit	472		
SIGHT MOVE 3-circuit	471		

# DALI. TECHNICALLY LIT.

All lighting components must feature a DALI interface. This allows up to 64 addresses, 16 groups and 16 scenes to be centrally managed. The status of a light or lighting control device is displayed and set using bi-directional data exchange via a DALI control device.

- The voltage ranges from 9.5 to 22.5V
- The system voltage is a maximum of 250 mA
- The data transmission rate is 1,200 baud
- DALI is optionally expandable

Heating appliances, air-conditioning units, blind systems and much more – if the 64 available addresses are not enough and additional building system components need to be centrally managed along with the lighting, that's no problem: DALI-based applications can be networked via a Gateway throughout different rooms and higher-level controls. A KNX system such as the new Schneider Electric KNX/ DALI Gateway is typically used.

STRUCTEC  
3-circuit, DALI



LED  
INSIDE



- Premium LED with CRI>90

## Product details

200-240V ~50/60Hz | 700mA  
Total wattage: 29W  
Material: aluminium  
Dimmable: Dali

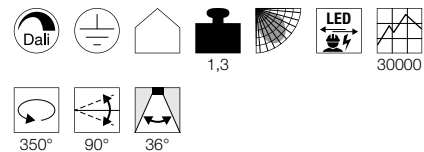

## Dimensional drawing

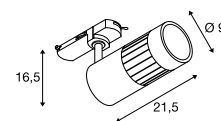

1003024 810

Variant	Item No.
2500lm   3000K   CR197	
■ matt black	1003024
2500lm   3000K   CR197	
□ matt white	1003025
2600lm   4000K   CR197	
■ matt black	1003026
2600lm   4000K   CR197	
□ matt white	1003027



1004690 811

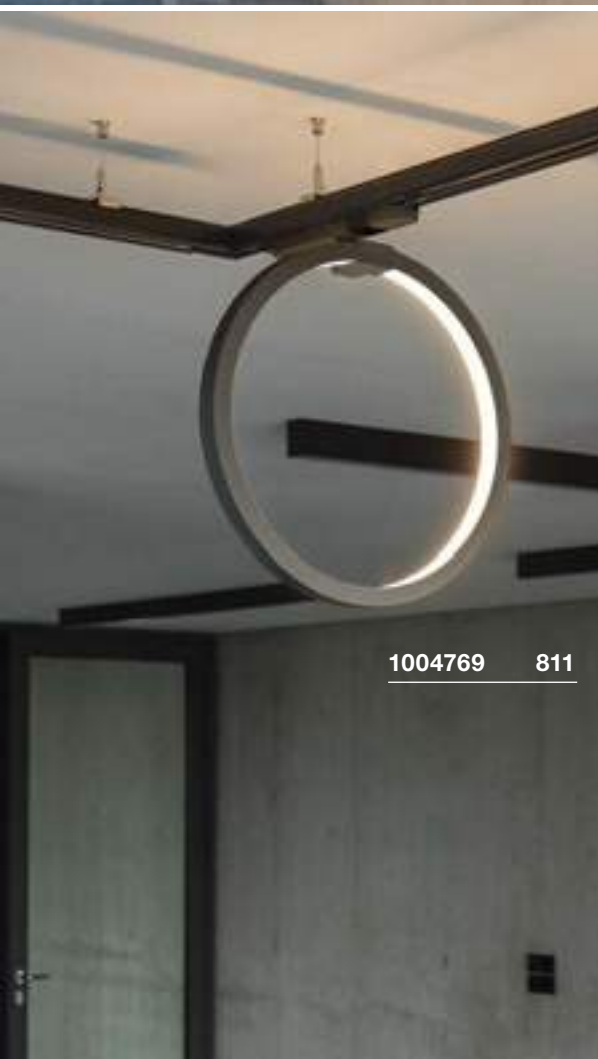

1004769 811

**SIGHT MOVE**  
3-circuit, DALI



**Product details**

220-240V ~50/60Hz | 350mA  
Total wattage: 26W  
Material: aluminium/polymethylacrylate (PMMA)  
Dimmable: Dali

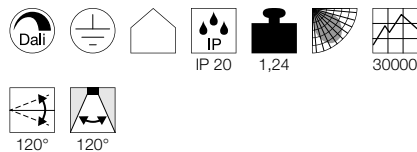

**Dimensional drawing**

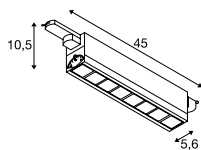

**ONE 40 TRACK**  
3-circuit, DALI



**Product details**

220-240V ~50/60Hz | 350mA  
System output: 15.2W  
Material: aluminium  
Dimmable: Dali

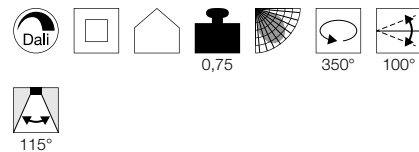

**Dimensional drawing**

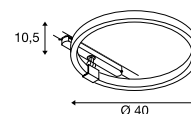













Variant	Item No.
2700lm   3000K   CRI>90	
■ matt black	1004690
2700lm   3000K   CRI>90	
□ matt white	1004691
3100lm   4000K   CRI>90	
■ matt black	1004692
3100lm   4000K   CRI>90	
□ matt white	1004693

Variant	Item No.
650lm   3000K   CRI90	
■ matt black	1004769
650lm   3000K   CRI90	
□ matt white	1004770
670lm   4000K   CRI90	
■ matt black	1004771
670lm   4000K   CRI90	
□ matt white	1004772

# MEDO LIGHTING SERIES.

## CEILING OR PENDANT LIGHTS.

	MEDO 30 AMBIENT CW, DALI	MEDO 40 AMBIENT CW, DALI	MEDO 60 AMBIENT CW, DALI	MEDO 90 AMBIENT CL, DALI
Example				
Lightbulb				
Size	Diameter: 30 cm	Diameter: 40 cm	Diameter: 60 cm	Diameter: 90 cm
Luminosity	Down: 1230/1280lm Up: 20lm	Down: 2750/2900lm Up: 50lm	Down: 4350/4750lm Up: 120lm	Down: 9500/10100lm Up: 125lm
UGR	25	25	25	25
Dimmable				
Suspension kit	1.5 m   5 m	1.5 m   5 m	1.5 m   5 m	1.5 m   5 m



All DALI-compatible products are identified with an icon in the BIG WHITE 2021.





**DALI INTERFACE**  
1-10V + on/off



0,02

**Product details**

220-240V ~50/60Hz  
Material: plastic  
L: 5.85 cm W: 3.25 cm H: 1.5 cm

**Tip**

For controlling electronic ballasts with 1-10V control input. Switching relay for additional on/off switching of the EB power supply. Galvanic isolation of DALI input and 1-10V output

Wattage up to 1000W

Variant	Item No.
■ grey	1002218

Manufacturer:  
LUNATONE Industrielle Elektronik GmbH

**DALI UNIVERSAL DIMMER**  
3-25W

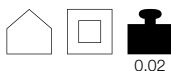

0,02

**Product details**

220-240V ~50/60Hz  
Material: plastic  
L: 5.85 cm W: 3.25 cm H: 1.5 cm

**Tip**

Suitable for R, L, and C load thanks to automatic load detection. DALI current consumption: 6mA

Wattage of 3W  
Wattage up to 25W

Variant	Item No.
■ grey	1002220

Manufacturer:  
LUNATONE Industrielle Elektronik GmbH

**DALI UNIVERSAL DIMMER**  
10-300W

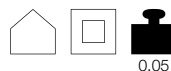

0,05

**Product details**

220-240V ~50/60Hz  
Material: plastic  
L: 12.02 cm W: 3.02 cm H: 2.16 cm

**Tip**

Suitable for R, L, and C load thanks to automatic load detection. DALI current consumption: 6mA

Wattage of 10W  
Wattage up to 300W

Variant	Item No.
□ white	1002221

Manufacturer:  
LUNATONE Industrielle Elektronik GmbH





# SIMPLE. COMPATIBLE. SMART.

## ZigBee® 3.0 – the smart wireless system.

Dimmers, changing colours, lighting moods at the push of a button: it's not only lighting systems that are based on the standard ZigBee® 3.0. The wireless standard is versatile, with minimum energy consumption and is easy to install, making it suitable for anyone who wants to easily network lights without having to deal with complicated technology. A theoretical range of up to 100 metres is possible for all types of living areas, houses and commercial buildings.

## The SLV VALETO® SMART LIGHT SYSTEM

The intelligent lighting solution for homes, hotels, restaurants and shops. Thanks to the ZigBee® 3.0 standard, you can enjoy compatibility with various common smart home systems:

### Schneider Electric | Philips Hue | Amazon Alexa | and much more

It is easily managed via remote control, app or Amazon Alexa. The SLV VALETO® SMART LIGHT SYSTEM is of course easy to integrate into existing electrical installations.

### Highly compatible.

### Tested with Schneider Electric products.

With the VALETO® SMART LIGHT SYSTEM, SLV offers a variety of system-compatible lighting management based on the ZigBee® 3.0 standard.

Schneider Electric PlusLink products, which support switch actuators, dimmers, blinds, motion sensors and 1-10V DALI interfaces, are easily integrated into the system.

This enables seamless integration of the switch design with various switch programmes. You can also look forward to many other application solutions as part of our future collaboration with Schneider Electric.



### Scalable:

Installations with up to 200 lights can be realised with the SLV VALETO® Gateway.



### Integrable:

SLV VALETO® is, thanks to the ZigBee® 3.0 standard, compatible with other manufacturers' products and systems.



### Controllable:

Easy to control via app, remote control or voice assistance systems.



### Coverage:

By integrating an own mesh network, SLV VALETO® products can also be controlled from large distances.\*



### Secure:

The Gateway only stores your data locally, never in the cloud.

\*Excluding battery-operated devices.

## SIMPLE.

The ideal starting point for smart lighting management: simply couple our SLV VALETO® remote controls (e.g.: 1002994) with the SLV VALETO® lights (e.g.: 1001917) and see how easy smart can be.



Remote control  
Item No. 1002994



Lightbulb  
Item No. 1001917



## ADVANCE.

### Would you like something more?

The choice is yours when it comes to the SLV VALETO® SMART LIGHT SYSTEM: manage your home lighting using our SLV VALETO® remote control (1002994), or an app on your smartphone via our SLV VALETO® Gateway (1002411). There are no limits when it comes to managing your smart lighting thanks to the latest ZigBee standard (ZigBee® 3.0).



12/24V Strip, control module  
Item No. 1001859



Lightbulb



Remote control  
Item No. 1002994



Gateway  
Item No. 1002411





## PROFESSIONAL.

### Major plans?

Easily integrate more than 150 smart products into a smart lighting management with our SLV VALETO® SMART LIGHT SYSTEM. Simply manage your lighting at any time, using any device, and perfectly showcase your projects.



12/24V Strip, control module  
Item No. 1001859



Lightbulb



Recessed wall dimmer  
Item No. 1002995



Gateway  
Item No. 1002411

## MORE COMFORT AND SECURITY

The perfect solution for wireless control and monitoring of individual lights, specific rooms or the entire home.

SLV VALETO® App

SLV VALETO® Gateway

Download on the App Store

GET IT ON Google Play



## COMMUNICATION.

The SLV VALETO® Gateway is at the heart of the smart lighting system

### SLV VALETO® Gateway

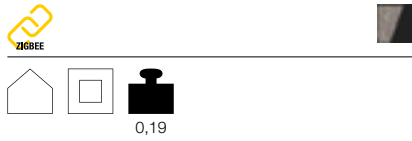

#### Product details

220-240V ~50/60Hz  
 Operating voltage: 5V DC  
 Wattage: <1W  
 L: 10.6 cm W: 10.6 cm H: 2.6 cm  
 Material: aluminium/plastic

#### Tip

ZigBee® 3.0 certified product. A router connection via a LAN cable is required to manage the Gateway.

#### Scope of delivery

SLV VALETO® Gateway  
 Steckernetzteil 5V, 1A  
 Network cable, CAT6, 2m, black

Variant	Item No.
■ Brushed/black metal	1002411



INTEGRABLE



GERMAN ENGINEERING



BANDWIDTH



SECURE



## LIGHTING.

### LED A60 E27, CCT



#### Product details

220-240V ~50/60Hz  
 Wattage: 9W  
 Diameter: 6 cm H: 12 cm

#### Tip

Remote-controllable and dimmable with SLV VALETO® CCT/RGBW remote control [1002994] or Gateway [1002411]

Lamp current	0.052A
Wattage	9W
Energy consumption/1000h	9kWh
Colour temperature	2700K-6500K
Luminous flux	806lm
Colour rendering index	>80

Variant	Item No.
	1001916

### LED A60 E27, RGBW



#### Product details

220-240V ~50/60Hz  
 Wattage: 9.5W  
 Diameter: 6 cm H: 12 cm

#### Tip

Remote-controllable and dimmable with SLV VALETO® CCT/RGBW remote control [1002994] or Gateway [1002411]

Lamp current	0.054A
Wattage	9.5W
Energy consumption/1000h	10kWh
Colour temperature	RGBW
Luminous flux	806lm
Colour rendering index	>80

Variant	Item No.
	1001917

### LED QPAR51 GU10, CCT

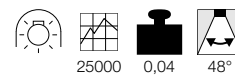

#### Product details

220-240V ~50/60Hz  
 Wattage: 5.1W  
 Diameter: 5 cm H: 5.4 cm

#### Tip

Remote-controllable and dimmable with SLV VALETO® CCT/RGBW remote control [1002994] or Gateway [1002411]

Lamp current	0.027A
Wattage	5.1W
Energy consumption/1000h	6kWh
Colour temperature	2700-6500K
Luminous flux	350lm
max. luminosity	500cd
Colour rendering index	>80

Variant	Item No.
	1001918

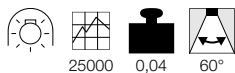

LIGHTING.

LED QPAR51  
GU10, RGBW

## Product details

220-240V ~50/60Hz  
Wattage: 5.6W  
Diameter: 5 cm H: 5.4 cm

## Tip

Remote-controllable and dimmable with SLV VALETO® CCT/RGBW remote control [1002994] or Gateway [1002411]

Lamp current	0.041A
Wattage	5.6W
Energy consumption/1000h	6kWh
Colour temperature	RGBW
Luminous flux	350lm
Colour rendering index	>80

Variant	Item No.
	1001919

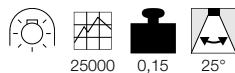
LED QPAR111  
GU10, CCT

## Product details

220-240V ~50/60Hz  
Wattage: 9W  
Diameter: 11.1 cm H: 7 cm

## Tip

Remote-controllable and dimmable with SLV VALETO® CCT/RGBW remote control [1002994] or Gateway [1002411]

Lamp current	0.048A
Wattage	9W
Energy consumption/1000h	9kWh
Colour temperature	2700K-6500K
Luminous flux	800lm
max. luminosity	3300cd
Colour rendering index	>80

Variant	Item No.
	1001920

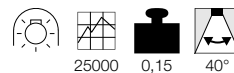
LED QPAR111  
GU10, CCT

## Product details

220-240V ~50/60Hz  
Wattage: 9W  
Diameter: 11.1 cm H: 7 cm

## Tip

Remote-controllable and dimmable with SLV VALETO® CCT/RGBW remote control [1002994] or Gateway [1002411]

Lamp current	0.048A
Wattage	9W
Energy consumption/1000h	9kWh
Colour temperature	2700K-6500K
Luminous flux	800lm
max. luminosity	1900cd
Colour rendering index	>80

Variant	Item No.
	1001921

LED QPAR111  
GU10, RGBW

## Product details

220-240V ~50/60Hz  
Wattage: 9W  
Diameter: 11.1 cm H: 7 cm

## Tip

Remote-controllable and dimmable with SLV VALETO® CCT/RGBW remote control [1002994] or Gateway [1002411]

Lamp current	0.048A
Wattage	9W
Energy consumption/1000h	9kWh
Colour temperature	RGBW
Luminous flux	800lm
Colour rendering index	>80

Variant	Item No.
	1001922

LED QPAR111  
GU10, RGBW

## Product details

220-240V ~50/60Hz  
Wattage: 9W  
Diameter: 11.1 cm H: 7 cm

## Tip

Remote-controllable and dimmable with SLV VALETO® CCT/RGBW remote control [1002994] or Gateway [1002411]

Lamp current	0.048A
Wattage	9W
Energy consumption/1000h	9kWh
Colour temperature	RGBW
Luminous flux	800lm
Colour rendering index	>80

Variant	Item No.
	1001923



## CONTROLS.

### SLV VALETO® remote control, CCT/RGBW



#### Product details

Voltage: 3V battery operation  
L: 6.5 cm W: 6.5 cm H: 1.95 cm  
Material: plastic PC

#### Tip

The SLV VALETO® CCT/RGBW remote control can manage up to 20 ZigBee® devices in three groups. CCT and RGBW settings available.

Variant	Item No.
white	1002994



## CONTROL DEVICE.

### SLV VALETO® Recessed wall dimmer



#### Product details

220-240V ~50/60Hz  
Wattage: max. 200W  
L: 4.5 cm W: 4.5 cm H: 2.2 cm  
Material: plastic PC

#### Tip

Controllable with SLV VALETO® CCT/RGBW remote control [1002994] or Gateway [1002411]  
Can be used as an independent dimmer without ZigBee®. Dimmer process: phase control.  
Dimmer for resistive (high-voltage halogen lamps) and capacitive loads (LED drivers). Suitable for all 60mm UP switch boxes with a depth of 42mm. 200W LED load.

Rated voltage	220-240V ~50/60Hz
Output voltage	220-240V ~50/60Hz
LED rated power	200W
Environmental temp. max.	50°C

Variant	Item No.
black	1002995

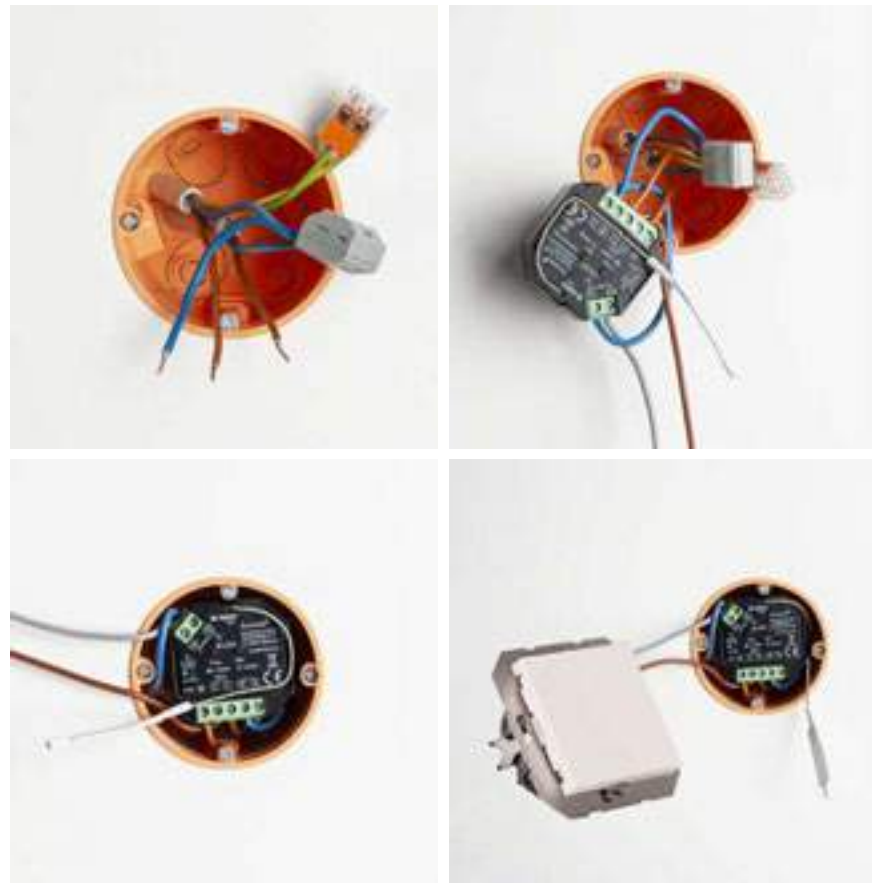



## CONTROL DEVICE.

### SLV VALETO® 12/24V Strip control module | CCT

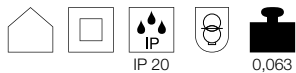

#### Product details

12V/24V DC  
Wattage: max. 192W per channel  
L: 13.4 cm W: 3.9 cm H: 2.4 cm  
Material: plastic

#### Tip

Remote-controllable and dimmable with SLV VALETO® CCT/RGBW remote control [1002994] or Gateway [1002411] The control module is suitable for managing CCT LED strips.

Output voltage	12/24V
Number of outputs sec.	2
Wattage of	1W
Wattage up to	192W
Environmental temp. min.	-30°C
Environmental temp. max.	60°C
Protection in the event of a fault	electronic

Variant	Item No.
<input type="checkbox"/> white	1001859

### SLV VALETO® 12/24V Strip control module| RGBW

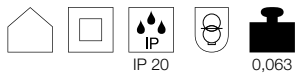

#### Product details

12V/24V DC  
Wattage: max. 96W per channel  
L: 13.4 cm W: 3.9 cm H: 2.4 cm  
Material: plastic

#### Tip

Remote-controllable and dimmable with SLV VALETO® CCT/RGBW remote control [1002994] or Gateway [1002411] The control module is suitable for managing RGBW LED strips.

Output voltage	12/24V
Number of outputs sec.	4
Wattage of	1W
Wattage up to	96W
Environmental temp. min.	-30°C
Environmental temp. max.	60°C
Protection in the event of a fault	electronic

Variant	Item No.
<input type="checkbox"/> white	1002892

### SLV VALETO® 15W, LED driver



#### Product details

220-240V~50/60Hz  
Wattage: 15W  
L: 19 cm W: 6.1 cm H: 3 cm  
Material: plastic

#### Tip

Remote-controllable and dimmable with SLV VALETO® CCT/RGBW remote control [1002994] or Gateway [1002411]

Output current	350mA, 500mA, 700mA
Number of outputs sec.	1
Wattage	15W
Environmental temp. min.	-20°C
Environmental temp. max.	40°C
Protection in the event of a fault	electronic

Variant	Item No.
<input type="checkbox"/> white	1002082



LED power supply 24V DC | 60W  
Item No. 470506



12/24V Strip control module | RGBW  
Item No. 1002892



GRAZIA PRO FLEXSTRIP RGBW 24V  
Item No. 1004727



Remote control  
Item No. 1002994

# SLV BLUETOOTH® CONTROL

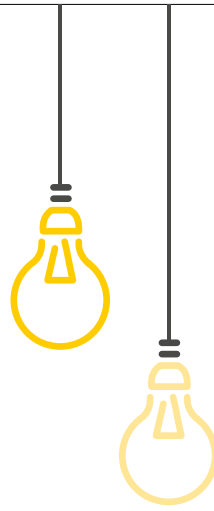

Advanced wireless light management simply based on Bluetooth® Low Energy (BLE).

The SLV BLUETOOTH® CONTROL solution enables lighting installations to be switched on and off and adjust the brightness. Lighting installations can be managed in groups or individually via the app.



## SLV BLUETOOTH® Recessed wall dimmer, PHASE

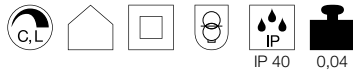

IP 40 0,04

### Product details

220-240V ~50/60Hz  
Wattage: 300W  
L: 4.5 cm W: 4.5 cm H: 2.2 cm  
Material: plastic PC  
Dimmable: C, L

### Tip

Can be used as an independent dimmer without Bluetooth. Dimmer process: phase control. Dimmer for resistive (high-voltage halogen lamps) and capacitive loads (LED drivers). Suitable for all 60mm UP switch boxes with a depth of 42mm. Low minimum load of 2W.

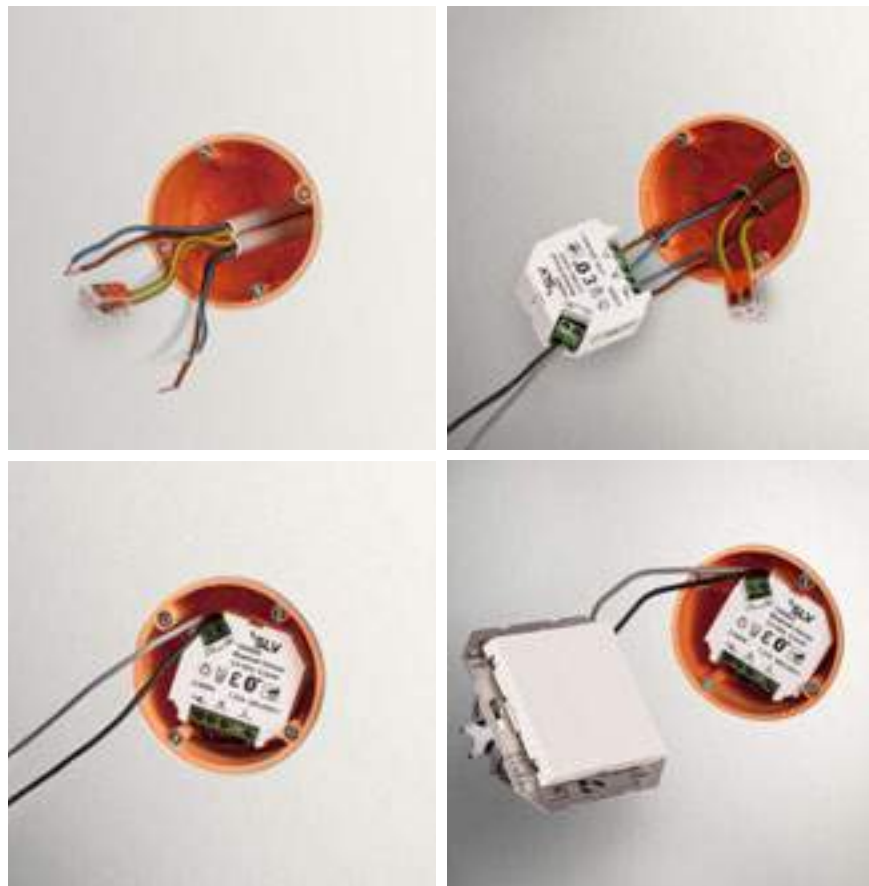

Voltage prim.	220-240V ~50/60Hz
Voltage sec.	220-240VAC
Output current	1.31 mA
Number of outputs sec.	1
Wattage	300W
Wattage of	2W
Wattage up to	300W
Wattage/outlet	300W
Environmental temp. max.	40°C
Protection in the event of a fault	electronic

Variant	Item No.
<input type="checkbox"/> white	1000826

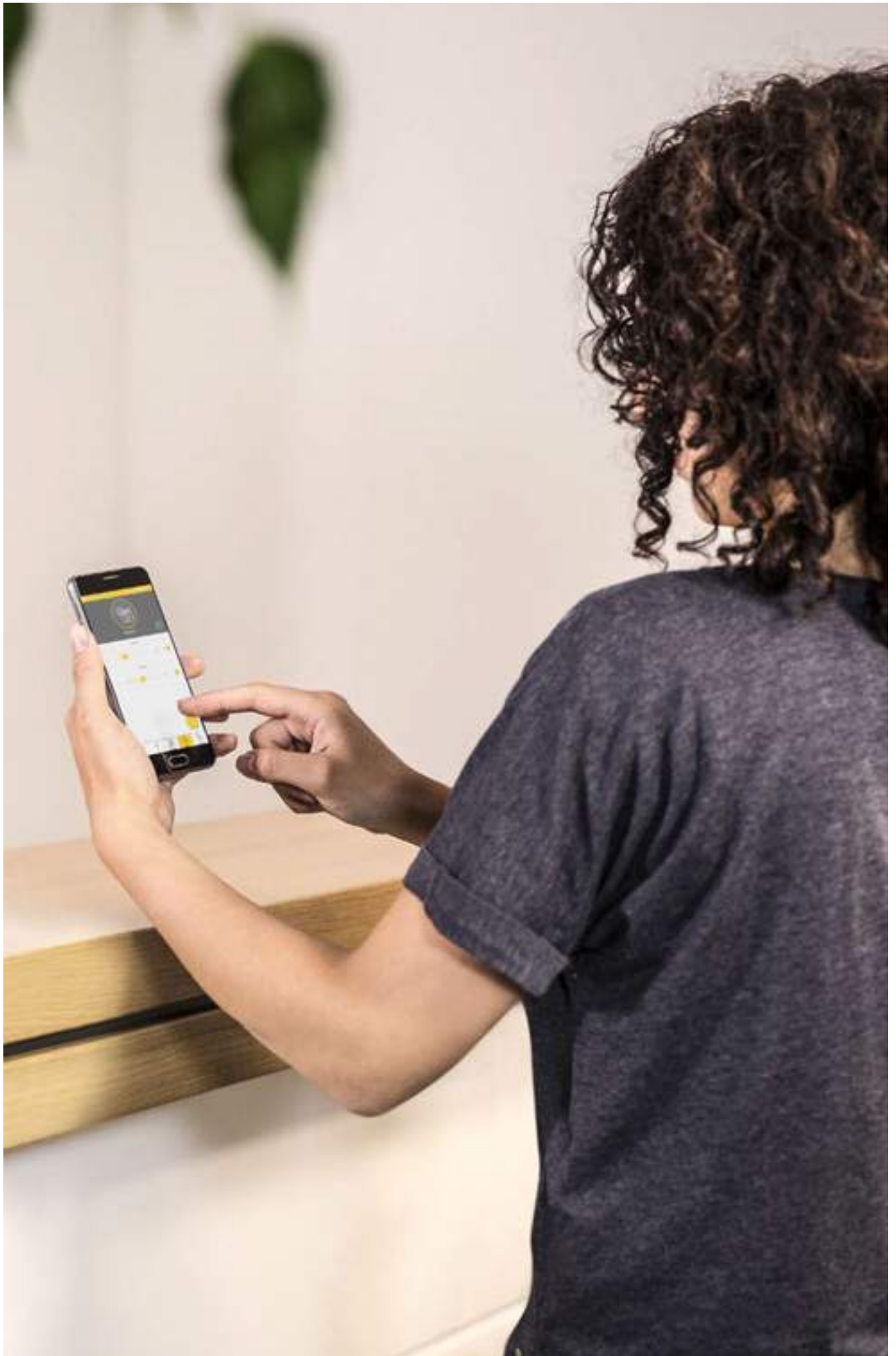

# YOUR BEAMING COMPANION.

## ACCESSORIES FOR INDIVIDUAL LIGHT AESTHETICS.

---

There are many different aspects to light. The possibilities are just as numerous when it is a case of lighting rooms and outside areas. These options can be extended with our accessories, and environments can literally be immersed in new light with different light installations.

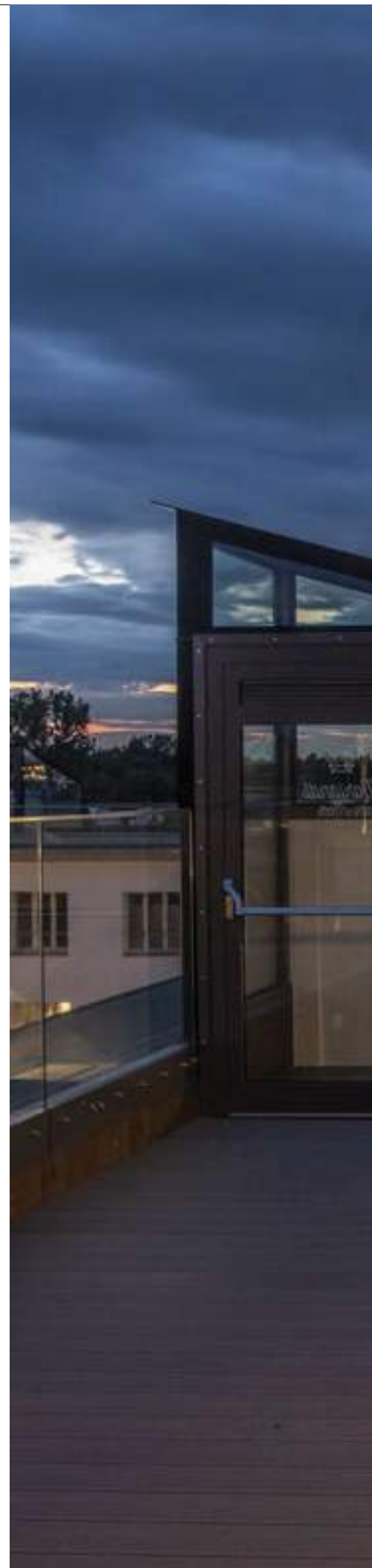



232435 239



# FIND A DIMMER. GOOD COMBINATION.

ATMOSPHERIC ROOM LIGHTING THANKS TO THE PERFECT COMBINATION OF LUMINAIRE AND DIMMER. **AT [FIND-A-DIMMER.SLV.COM](https://www.find-a-dimmer.slv.com)**

Attention must be paid to the compatibility of the luminaires or lamps with the dimmer when dimming. And particularly with LED lamps, it must be checked beforehand which dimmer is required. In view of the many different products, it is not always easy to find the best combination. Our "Find a Dimmer" overview should help you to do this. As well as numerous combinations consisting of different luminaires and lamps and

dimmers, at [find-a-dimmer.slv.com](https://www.find-a-dimmer.slv.com) you will also find more information about the minimum number of luminaires or lamps that are needed for problem-free operation. **The overview is updated and extended at regular intervals.**

For specific enquiries, please contact our technical support at [service@slv.de](mailto:service@slv.de).



## 1 Suitable

- Ideal dimming behaviour
- The minimum number of luminaires/ lamps that are needed for problem-free operation is specified as a number.

## Conditionally suitable

- No optimum dimming behaviour
- Flickering possible

## Not compatible



[find-a-dimmer.slv.com](https://www.find-a-dimmer.slv.com)



## ACCESSORIES

<b>Transformers</b> 12V AC  828	<b>Transformers IP44</b> 12V AC  828	<b>Transformers TENSEO</b> 12V AC  829	<b>Transformers</b> 12V AC  830
<b>Transformers</b> 12V AC  830	<b>DALI interface</b> 1-10V  830	<b>DALI Universal Dimmer</b>  830	<b>DALI Controller</b>  830
<b>1-10V Dimmer</b>  831	<b>LED mains adapter</b> 12V/24V DC  831	<b>LED mains adapter</b> 24V DC  831	<b>LED mains adapter</b> 24V DC  832
<b>Compensation module</b>  833	<b>LED driver</b> Dimmable  833-835	<b>LED driver</b> VALETO®  835, 839	<b>LED driver</b> DALI dimmable  837
<b>LED driver</b> not dimmable  838-839	<b>Ceiling hook</b>  840	<b>Cable clamp</b>  840	<b>Ceiling roses</b>  841
<b>Textile cable</b> 10 m  841	<b>cable</b> 10 m clear  841	<b>Wire rope suspension</b>  841	<b>Stopper</b> for wire rope  841
<b>Connector strip</b> 3 outlets  842	<b>socket</b> GU10  842	<b>Cable extensions</b> 1 m 2 m  842	<b>socket</b> GU10  842
<b>Double-sided tape</b>  842	<b>Connection boxes</b>  843	<b>T-connector boxes</b>  843	

### TRANSFORMER

12V AC | 105VA



#### Product details

230V -50Hz  
L: 11 cm W: 7.5 cm H: 8 cm  
**Dimmable: L**

Voltage sec.	12V AC
Number of outputs sec.	1
Nominal wattage VA	105
Wattage up to	105W
Thermal protection	110°C

Variant	Item No.
white	451105

Manufacturer:  
Elektromaschinenbau Wittlich GmbH

### TRANSFORMER

12V AC | 300VA



#### Product details

230V -50Hz  
L: 9 cm W: 13 cm H: 11 cm  
**Dimmable: L**

Voltage sec.	12V AC
Number of outputs sec.	1
Nominal wattage VA	300
Wattage up to	300W
Thermal protection	110°C

Variant	Item No.
white	451301

Manufacturer:  
Elektromaschinenbau Wittlich GmbH

### TRANSFORMER

12V AC | 10VA IP44



#### Product details

230V -50Hz  
Material: plastic  
L: 7.5 cm W: 5 cm H: 4.5 cm  
**Dimmable: L**

Voltage sec.	12V AC
Number of outputs sec.	1
Nominal wattage VA	10
Wattage up to	10W
Thermal protection	133°C

Variant	Item No.
black	227140

Manufacturer:  
Elektromaschinenbau Wittlich GmbH

### TRANSFORMER

12V AC | 60VA IP44



#### Product details

230V -50Hz  
Material: plastic  
L: 6 cm W: 10 cm H: 6.3 cm  
**Dimmable: L**

Voltage sec.	12V AC
Number of outputs sec.	1
Nominal wattage VA	60
Wattage up to	60W
Thermal protection	133°C

Variant	Item No.
black	227160

Manufacturer:  
Elektromaschinenbau Wittlich GmbH

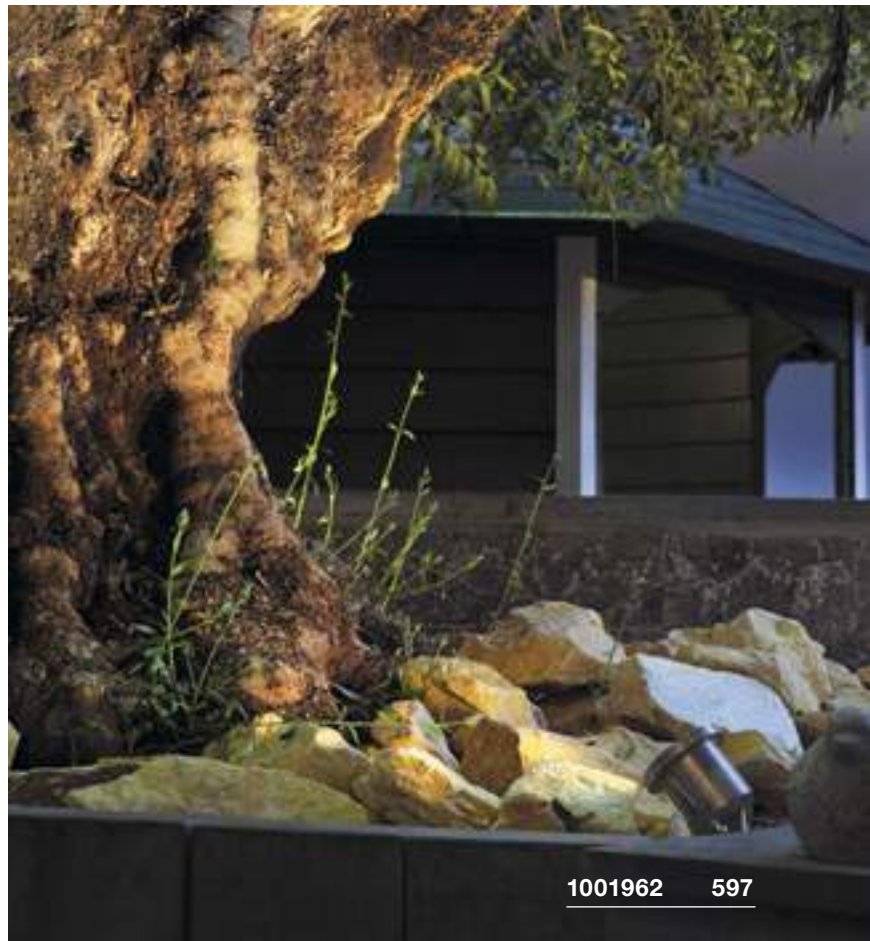

1001962 597

**TRANSFORMER TENSEO**  
12V AC | 50VA



**Product details**

230V -50Hz  
Material: steel/brass  
Diameter: 11.1 cm H: 11cm  
**Dimmable: L**

Voltage sec.	12V AC
Number of outputs sec.	1
Nominal wattage VA	50
Wattage up to	50W
Thermal protection	130°C
Protection prim.	1.6A

Variant	Item No.
■ black	1002691
□ white	1002692
■ chrome	1002693

**TRANSFORMER TENSEO**  
12V AC | 105VA

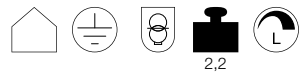

**Product details**

230V -50Hz  
Material: steel/brass  
Diameter: 11 cm H: 11 cm  
**Dimmable: L**

Voltage sec.	12V AC
Number of outputs sec.	1
Nominal wattage VA	105
Wattage up to	105W
Thermal protection	130°C
Protection prim.	1.6A

Variant	Item No.
■ black	138980
□ white	138981
■ chrome	138982

**TRANSFORMER TENSEO**  
12V AC | 210VA



**Product details**

230V -50Hz  
Material: steel/brass  
Diameter: 13.5 cm H: 11 cm  
**Dimmable: L**

Voltage sec.	12V AC
Number of outputs sec.	1
Nominal wattage VA	210
Wattage up to	210W
Thermal protection	130°C
Protection prim.	3.15A

Variant	Item No.
■ black	138990
□ white	138991
■ chrome	138992

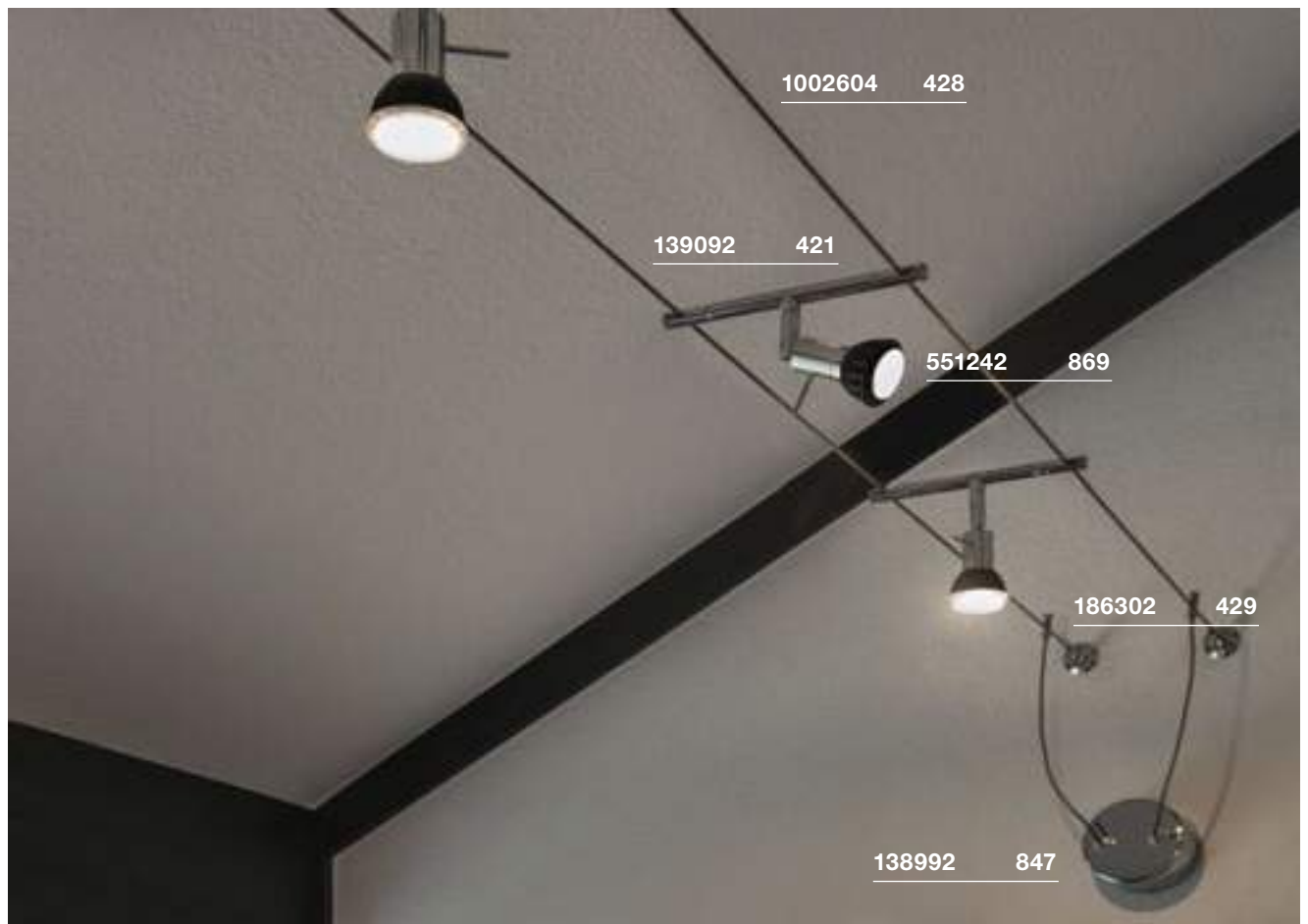

**TRANSFORMER**  
12V AC | 60VA

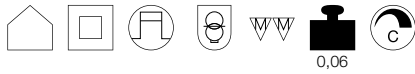

**Product details**

230V -50Hz  
Material: plastic PC  
L: 10.5 cm W: 3.3 cm H: 2.2 cm  
**Dimmable: C**

Voltage sec.	12V AC
Number of outputs sec.	1
Wattage of	10W
Wattage up to	60W
Power factor	0,98
Thermal protection	110°C

Variant	Item No.
white	461060

Manufacturer:  
WeiSen Electronic Co., Ltd

**TRANSFORMER**  
12V AC | 150VA

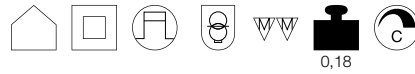

**Product details**

230V -50Hz  
Material: plastic  
L: 16.6 cm W: 3.9 cm H: 3.3 cm  
**Dimmable: C**

Voltage sec.	12V AC
Number of outputs sec.	3
Wattage of	50W
Wattage up to	150W
Thermal protection	110°C
Protection prim.	3.15A

Variant	Item No.
black	461157

Manufacturer:  
WeiSen Electronic Co., Ltd

**DALI INTERFACE**  
1-10V + on/off

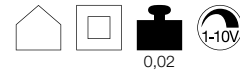

**Product details**

220-240V ~50/60Hz  
Material: plastic  
L: 5.85 cm W: 3.25 cm H: 1.5 cm

Wattage up to	1000W
---------------	-------

Variant	Item No.
grey	1002218

Manufacturer:  
LUNATONE Industrielle Elektronik GmbH

**Tip**

For controlling electronic ballasts with 1-10V control input. Switching relay for additional on/off switching of the EB power supply. Galvanic isolation of DALI input and 1-10V output

**DALI UNIVERSAL DIMMER**  
3-25W

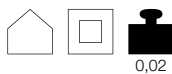

**Product details**

220-240V ~50/60Hz  
Material: plastic  
L: 5.85 cm W: 3.25 cm H: 1.5 cm

Wattage of	3W
Wattage up to	25W

Variant	Item No.
grey	1002220

Manufacturer:  
LUNATONE Industrielle Elektronik GmbH

**DALI UNIVERSAL DIMMER**  
10-300W

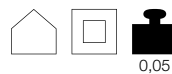

**Product details**

220-240V ~50/60Hz  
Material: plastic  
L: 12.02 cm W: 3.02 cm H: 2.16 cm

Wattage of	10W
Wattage up to	300W

Variant	Item No.
white	1002221

Manufacturer:  
LUNATONE Industrielle Elektronik GmbH

**Tip**

Suitable for R, L, and C load thanks to automatic load detection. DALI current consumption: 6mA

**DALI CONTROLLER**  
24V DC

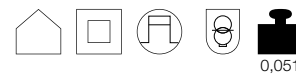

**Product details**

10-24V DC  
Material: plastic PC  
L: 11.6 cm W: 4.2 cm H: 1.8 cm

Wattage of	3W
Wattage up to	25W

Variant	Item No.
white/grey	1003106

Manufacturer:  
LUNATONE Industrielle Elektronik GmbH

**Tip**

Suitable for controlling LEDs with a constant voltage of 10-24V / DC - Controlsignal DALI or Push-Dim

### 1-10V DIMMER 10W



#### Product details

10W  
Material: plastic PC  
L: 2.3 cm W: 3.9 cm H: 2 cm

#### Tip

Suitable for dimming of  
1-10V electronic ballasts

### LED MAINS ADAPTER 12V/24V DC | 12W round

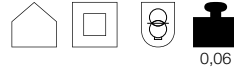

#### Product details

100-240V ~50/60Hz  
Material: plastic PC  
Diameter: 5.5 cm H: 2.2 cm

### LED MAINS ADAPTER 12V/24V DC | 12W

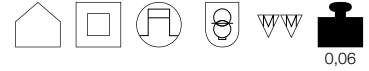

#### Product details

220-240V ~50/60Hz  
Material: plastic PC  
L: 8.5 cm W: 4 cm H: 2.2 cm

Voltage sec.	12V/24V DC
Number of outputs sec.	1
Nominal wattage VA	12
Wattage up to	12W
Thermal protection	110°C

Voltage sec.	12V/24V DC
Number of outputs sec.	2
Wattage up to	12W
Thermal protection	110°C

Variant	Item No.
<input type="checkbox"/> white	470505

Manufacturer:  
WeiSen Electronic Co., Ltd

Variant	Item No.
<input type="checkbox"/> white   12V	470545
<input type="checkbox"/> white   24V	470546

Manufacturer:  
WeiSen Electronic Co., Ltd

Variant	Item No.
<input type="checkbox"/> white   12V	470507
<input type="checkbox"/> white   24V	470502

Manufacturer:  
WeiSen Electronic Co., Ltd

### LED MAINS ADAPTER 12V/24V DC | 20W

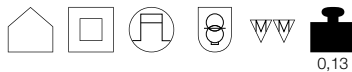

#### Product details

230V ~50Hz  
Material: plastic PC  
L: 16.6 cm W: 3.9 cm H: 3.3 cm

### LED MAINS ADAPTER 24V DC | 36W

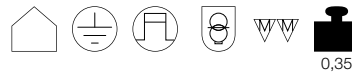

#### Product details

100-240 V~50/60Hz  
Material: plastic PC  
L: 12.9 cm W: 7.5 cm H: 3.2 cm

### LED MAINS ADAPTER 24V DC | 60W

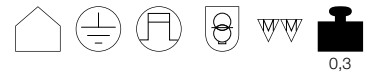

#### Product details

220-240V ~50/60Hz  
Material: plastic PC  
L: 17.5 cm W: 7.8 cm H: 3.5 cm

Voltage sec.	12V/24V DC
Number of outputs sec.	1
Wattage up to	20W
Thermal protection	110°C

Voltage sec.	24V DC
Number of outputs sec.	1
Wattage up to	36W
Power factor	0,9
Thermal protection	110°C

Voltage sec.	24V DC
Number of outputs sec.	2
Wattage up to	60W
Power factor	0,95
Thermal protection	110°C

Variant	Item No.
<input type="checkbox"/> white   12V	470541
<input type="checkbox"/> white   24V	470542

Manufacturer:  
WeiSen Electronic Co., Ltd

Variant	Item No.
<input checked="" type="checkbox"/> black	470544

Manufacturer:  
WeiSen Electronic Co., Ltd

Variant	Item No.
<input type="checkbox"/> white	470506

Manufacturer:  
WeiSen Electronic Co., Ltd

### LED MAINS ADAPTER

24V | 100W

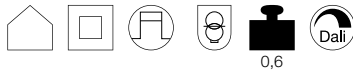

#### Product details

220-240V ~50/60Hz  
Material: metal  
L: 34.7 cm W: 4 cm H: 2.2 cm  
**Dimmable: Dali**

Voltage sec.	24V
Wattage of	1W
Wattage up to	100W
Thermal protection	110°C
Power factor	0,9

Variant	Item No.
■ silver	1004776

Manufacturer:  
WeiSen Electronic Co., Ltd

### LED MAINS ADAPTER

24V DC | 100W

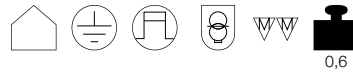

#### Product details

220-240V ~50/60Hz  
Material: plastic PC  
L: 18.2 cm W: 8.8 cm H: 3.5 cm

Voltage sec.	24V DC
Number of outputs sec.	2
Wattage up to	100W
Power factor	0,95
Thermal protection	110°C

Variant	Item No.
■ black	470500

Manufacturer:  
WeiSen Electronic Co., Ltd

### LED MAINS ADAPTER

24V DC | 150W

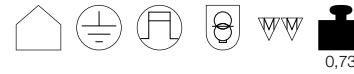

#### Product details

220-240V ~50/60Hz  
Material: plastic PC  
L: 20.7 cm W: 11 cm H: 4.5 cm

Voltage sec.	24V DC
Number of outputs sec.	1
Wattage up to	150W
Thermal protection	110°C

Variant	Item No.
■ black	470549

Manufacturer:  
WeiSen Electronic Co., Ltd

### LED MAINS ADAPTER

24V DC | 150W

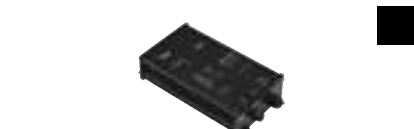

#### Product details

220-240V ~50/60Hz  
Material: plastic PC  
L: 23.4 cm W: 11.4 cm H: 4.9 cm

Voltage sec.	24V DC
Number of outputs sec.	1
Wattage up to	150W
Thermal protection	110°C

Variant	Item No.
■ black	470548

Manufacturer:  
WeiSen Electronic Co., Ltd

### LED MAINS ADAPTER

24V DC | 20W

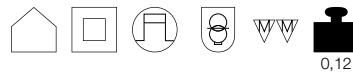

#### Product details

220-240V ~50/60Hz  
Material: plastic PC  
L: 14.6 cm W: 5.5 cm H: 1.9 cm  
**Dimmable: 1-10V**

Voltage sec.	24V DC
Number of outputs sec.	1
Wattage up to	20W
Thermal protection	100°C

Variant	Item No.
□ white	470547

Manufacturer:  
TCI Telecomunicazioni Italia Srl

### LED MAINS ADAPTER

24V DC | 100W

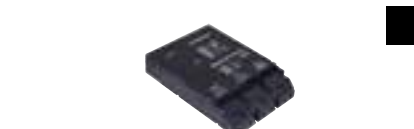

#### Product details

220-240V ~50/60Hz  
Material: plastic PC  
L: 19 cm W: 13 cm H: 3.5 cm  
**Dimmable: 1-10V**

Voltage sec.	24V DC
Number of outputs sec.	3
Wattage up to	100W
Wattage/outlet	33W
Power factor	0,95
Thermal protection	110°C
Protection in the event of a fault	Short circuit protected & open circuit proof °C

Variant	Item No.
■ black	470540

Manufacturer:  
WeiSen Electronic Co., Ltd



### LED MAINS ADAPTER 24V DC | 50W

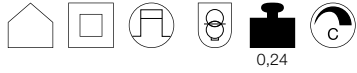

**Product details**

220-240V ~50/60Hz  
Material: plastic PC  
L: 18.4 cm W: 6.1 cm H: 3.2 cm  
**Dimmable: C**

Voltage sec.	24V DC
Wattage of	12W
Wattage up to	50W
Thermal protection	110°C

Variant	Item No.
white/blue	1003104

### LED MAINS ADAPTER 24V DC | 100W

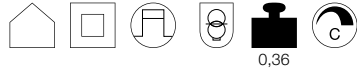

**Product details**

220-240V ~50/60Hz  
Material: plastic PC  
L: 21 cm W: 6.7 cm H: 3.4 cm  
**Dimmable: C**

Voltage sec.	24V DC
Wattage of	34W
Wattage up to	100W
Thermal protection	110°C

Variant	Item No.
white/blue	1003105

### COMPENSATION MODULE

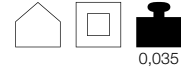

**Product details**

220-240V ~50/60Hz  
Material: plastic PC  
L: 9.5 cm Diameter: 1.5 cm

**Tip**

Reduces or eradicates problems encountered when dimming, such as flickering or flashing, or if the LED illumination is not 100% eliminated when switched off. The compensator is always connected after the dimmer or switch and parallel to the downlight spot or LED driver.

Variant	Item No.
black	1002785

### LED ADAPTER 350mA | 6W

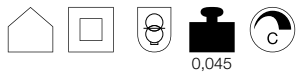

**Product details**

220-240V ~50/60Hz  
Material: plastic PC  
L: 6.3 cm W: 4 cm H: 2.3 cm  
**Dimmable: C**

Voltage sec.	10-17V DC
Wattage of	3.5W
Wattage up to	5.9W
Power factor	0,9
Thermal protection	110°C

Variant	Item No.
white	1002791

Manufacturer:  
WeiSen Electronic Co., Ltd

### LED DRIVER 350mA | 10W

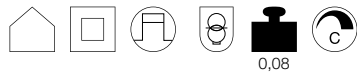

**Product details**

220-240V ~50/60Hz  
Material: plastic PC  
L: 8.5 cm W: 4.1 cm H: 2.2 cm  
**Dimmable: C**

Voltage sec.	17-29V DC
Output current	350mA
Wattage	10W
Wattage of	5.95W
Wattage up to	10.15W
Power factor	0,9
Thermal protection	110°C

Variant	Item No.
white	464140

Manufacturer:  
WeiSen Electronic Co., Ltd

### LED DRIVER 350mA | 15W

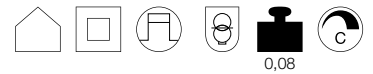

**Product details**

220-240V ~50/60Hz  
Material: plastic PC  
L: 8.5 cm W: 4.1 cm H: 2.2 cm  
**Dimmable: C**

Voltage sec.	18-30V DC
Output current	350mA
Wattage of	9W
Wattage up to	15W
Power factor	0,9
Thermal protection	110°C

Variant	Item No.
white	1002803

Manufacturer:  
WeiSen Electronic Co., Ltd

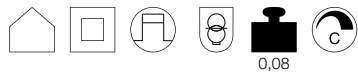
LED DRIVER  
500mA | 15W

0,08

## Product details

220-240V ~50/60Hz  
Material: plastic PC  
L: 8.5 cm W: 4.1 cm H: 2.2 cm  
**Dimmable: C**

Voltage sec.	26-43V DC
Output current	500mA
Wattage of	9.1W
Wattage up to	15W
Power factor	0,9
Thermal protection	110°C

Variant	Item No.
<input type="checkbox"/> white	<b>464144</b>

Manufacturer:  
WeiSen Electronic Co., Ltd

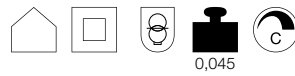
LED DRIVER  
700mA | 6W

0,045

## Product details

220-240V ~50/60Hz  
Material: plastic PC  
L: 6.3 cm W: 4 cm H: 2.3 cm  
**Dimmable: C**

## Tip

Suitable with mounting boxes with a diameter of 60 mm and a min. installation depth of 42 mm

Voltage sec.	4.8-8.6V
Output current	700mA
Wattage of	3.4W
Wattage up to	6W
Power factor	0,9
Thermal protection	110°C

Variant	Item No.
<input type="checkbox"/> white	<b>1002792</b>

Manufacturer:  
WeiSen Electronic Co., Ltd

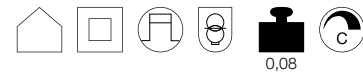
LED DRIVER  
700mA | 10W inc. strain relief

0,08

## Product details

220-240V ~50/60Hz  
Material: plastic PC  
L: 8.5 cm W: 4.1 cm H: 2.2 cm  
**Dimmable: C**

Voltage sec.	40-57V
Output current	700mA
Wattage of	6W
Wattage up to	10.5W
Power factor	0,9
Thermal protection	110°C

Variant	Item No.
<input type="checkbox"/> white	<b>464142</b>

Manufacturer:  
WeiSen Electronic Co., Ltd

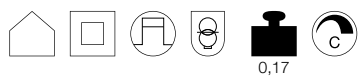
LED DRIVER  
700mA | 39W inc. strain relief

0,17

## Product details

220-240V ~50/60Hz  
Material: PC  
L: 16.6 cm W: 5.2 cm H: 2.4 cm  
**Dimmable: C**

Voltage sec.	28-56V
Output current	700mA
Wattage of	20W
Wattage up to	39W
Power factor	0,95
Thermal protection	110°C

Variant	Item No.
<input checked="" type="checkbox"/> white/blue	<b>1001267</b>

Manufacturer:  
WeiSen Electronic Co., Ltd

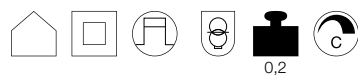
LED DRIVER  
700mA | 40W inc. strain relief

0,2

## Product details

220-240V ~50/60Hz  
Material: plastic PC  
L: 15.3 cm W: 6.7 cm H: 3 cm  
**Dimmable: C**

Voltage sec.	40-57V
Output current	700mA
Wattage of	28W
Wattage up to	39.9W
Power factor	0,9
Thermal protection	110°C

Variant	Item No.
<input type="checkbox"/> white	<b>1001114</b>

Manufacturer:  
WeiSen Electronic Co., Ltd

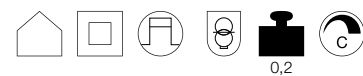
LED DRIVER  
1000mA | 40W

0,2

## Product details

220-240V ~50/60Hz  
Material: plastic PC  
L: 15.3 cm W: 6.7 cm H: 3 cm  
**Dimmable: C**

Voltage sec.	28-40V
Output current	1000mA
Number of outputs sec.	1
Wattage of	28W
Wattage up to	40W
Power factor	0,9
Thermal protection	110°C

Variant	Item No.
<input type="checkbox"/> white	<b>1001115</b>

Manufacturer:  
WeiSen Electronic Co., Ltd

**LED DRIVER**  
1050mA | 40W inc. strain relief

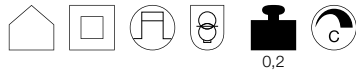

**Product details**

220-240V ~50/60Hz  
Material: plastic PC  
L: 16.6 cm W: 5.2 cm H: 2.4 cm  
**Dimmable: C**

Voltage sec.	19-38
Output current	1050mA
Number of outputs sec.	2
Wattage up to	40W
Power factor	0,95
Thermal protection	110°C

Variant	Item No.
<input type="checkbox"/> white	<b>464804</b>

**LED DRIVER**  
200mA | 6-8.4W inc. strain relief

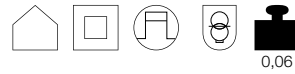

**Product details**

220-240V ~50/60Hz  
Material: Polycarbonate (PC)  
L: 8.5 cm W: 4.1 cm H: 2.2 cm

Voltage sec.	30-42V
Output current	250mA
Number of outputs sec.	1
Wattage of	6W
Wattage up to	8.4W
Power factor	0,9
Thermal protection	110°C

Variant	Item No.
<input type="checkbox"/> white	<b>1003254</b>

**LED DRIVER**  
250mA | 10W

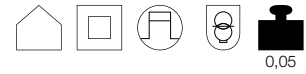

**Product details**

220-240V ~50/60Hz  
Material: Polycarbonate (PC)  
L: 6.5 cm W: 3.9 cm H: 2 cm

Voltage sec.	26-40V DC
Output current	250mA
Number of outputs sec.	1
Wattage of	6.5W
Wattage up to	10W
Power factor	0,9
Thermal protection	110°C

Variant	Item No.
<input type="checkbox"/> white	<b>1004780</b>

Manufacturer:  
WeiSen Electronic Co., Ltd

**SLV VALETO®**  
350/500/700mA | 15W, LED driver

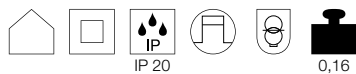

**Product details**

220-240V~50/60Hz  
Wattage: 15W  
L: 19 cm W: 6.1 cm H: 3 cm  
Material: plastic

**Tip**

Remote-controllable and dimmable with SLV VALETO® CCT/RGBW remote control [1002994] or Gateway [1002411]

Output current	350/500/700mA
Number of outputs sec.	1
Wattage	15W
Environmental temp. min.	-20°C
Environmental temp. max.	40°C
Protection in the event of a fault	electronic

Variant	Item No.
<input type="checkbox"/> white	<b>1002082</b>

**LED DRIVER**  
500/600/700mA | 30W inc. strain relief

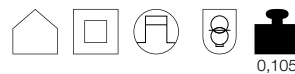

**Product details**

220-240V ~50/60Hz  
Material: Polycarbonate (PC)  
L: 14.7 cm W: 4.3 cm H: 3 cm

Voltage sec.	30-42V DC
Output current	500/600/700 mA
Number of outputs sec.	1
Wattage of	21W
Wattage up to	29.5W
Power factor	0,9
Thermal protection	110°C

Variant	Item No.
<input type="checkbox"/> white	<b>1004781</b>

Manufacturer:  
WeiSen Electronic Co., Ltd

**LED DRIVER**  
800/900/1050mA | 40W inc. strain relief

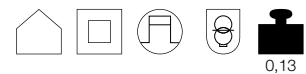

**Product details**

220-240V ~50/60Hz  
Material: Polycarbonate (PC)  
L: 14.7 cm W: 4.3 cm H: 3 cm

Voltage sec.	30-42V DC
Output current	800/900/1050 mA
Number of outputs sec.	1
Wattage of	31.5W
Wattage up to	44W
Power factor	0,9
Thermal protection	110°C

Variant	Item No.
<input type="checkbox"/> white	<b>1004782</b>

Manufacturer:  
WeiSen Electronic Co., Ltd



1002631 339

1002675 335

## DALI – THE FLEXIBLE LIGHTING SOLUTION

What is DALI? DALI is a system for freely configuring flexible light scenarios and arrangements. This bus-compatible system makes it possible to individually access, control and evaluate light and all components of a lighting system. Luminaires, groups of luminaires and even the lighting of entire buildings are controlled in this way.

You can create a special atmosphere in your retail premises with our DALI system. Your lighting is configured in a flexible way by using DALI spotlights in conjunction with our special DALI adapters and tracks. Thanks to the wide range of accessories, any configuration that is required can be realised. Be it ceiling or wall installation, or as a pendant.

The tracks consist of an extruded aluminium profile that is painted in white or black. The tracks are available in different lengths with an integrated 2-core DALI cable, and can be cut to length in accordance with requirements. Suitable luminaires with a high CRI of >90 are also available for this system.

### LED DRIVER DALI

250-700mA | 20W inc. strain relief

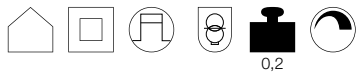

#### Product details

220-240V ~50/60Hz  
Material: PC  
L: 15 cm W: 5.2 cm H: 2.8 cm  
**Dimmable: 1-10V / Dali**

#### Tip

250/350/500/700mA  
Output current can be adjusted using DIP switch

Voltage sec.	6-60V
Wattage of	1.5W
Wattage up to	20W
Thermal protection	110°C
Power factor	0,9

Variant	Item No.
<input type="checkbox"/> white	<b>1002423</b>

Manufacturer:  
WeiSen Electronic Co., Ltd

### LED DRIVER DALI

250-700mA | 40W inc. strain relief

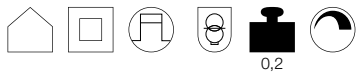

#### Product details

220-240V ~50/60Hz  
Material: PC  
L: 12.3 cm W: 7.9 cm H: 2.4 cm  
**Dimmable: 1-10V / Dali**

#### Tip

250/350/500/700mA  
Output current can be adjusted using DIP switch

Voltage sec.	6-58V
Wattage of	1.5W
Wattage up to	40W
Thermal protection	110°C
Power factor	0,9

Variant	Item No.
<input type="checkbox"/> white	<b>1002424</b>

Manufacturer:  
WeiSen Electronic Co., Ltd

### LED DRIVER DALI

350-1050mA | 60W inc. strain relief

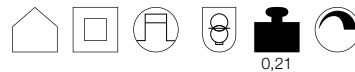

#### Product details

220-240V ~50/60Hz  
Material: PC  
L: 12.4 cm W: 7.9 cm H: 2.2 cm  
**Dimmable: 1-10V / Dali**

#### Tip

350/500/550/650/700/750/  
850/900/1000/1050mA  
Output current can be adjusted using DIP switch

Voltage sec.	2-74V
Wattage of	1W
Wattage up to	60W
Thermal protection	110°C
Power factor	0,95

Variant	Item No.
<input type="checkbox"/> white	<b>464032</b>

Manufacturer:  
TCI Telecomunicazioni Italia Srl

### LED DRIVER DALI

700-1500mA | 50W inc. strain relief

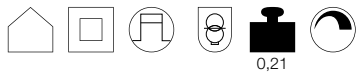

#### Product details

220-240V ~50/60Hz  
Material: PC  
L: 12.3 cm W: 7.9 cm H: 2.4 cm  
**Dimmable: 1-10V / Dali**

#### Tip

700/800/900/1050/1200/1300/1400mA  
Output current can be adjusted using DIP switch

Voltage sec.	6-58V
Wattage of	4.2W
Wattage up to	50W
Thermal protection	110°C
Power factor	0,9

Variant	Item No.
<input type="checkbox"/> white	<b>1002425</b>

Manufacturer: WeiSen Electronic Co., Ltd

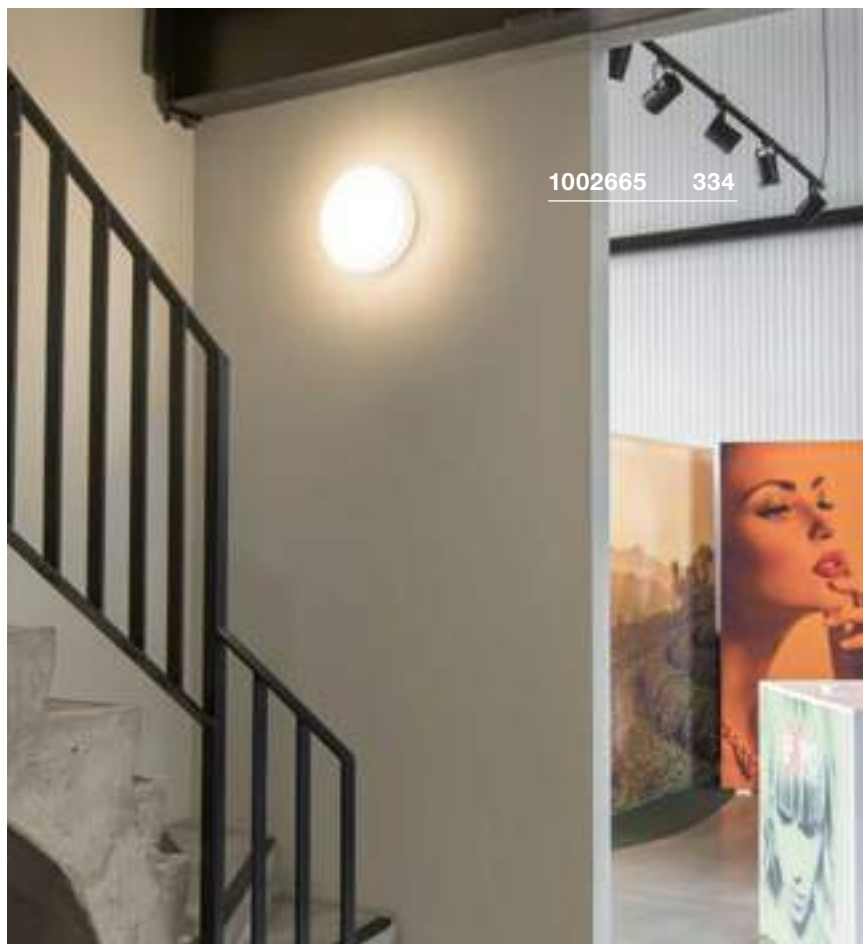

### LED DRIVER

320mA | 3W inc. strain relief



#### Product details

100-240V ~50/60Hz  
Material: plastic PC  
L: 5.5 cm W: 3.9 cm H: 2 cm

Voltage sec.	3-9V
Output current	320mA
Wattage of	1W
Wattage up to	3W
Power factor	0,4
Thermal protection	110°C
Wattage-L sec. max.	2 m

Variant	Item No.
<input type="checkbox"/> white	464108

Manufacturer:  
WeiSen Electronic Co., Ltd

### LED DRIVER

350mA | 3W inc. strain relief

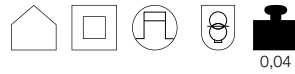

#### Product details

230V -50Hz  
Material: plastic PC  
L: 5.6 cm W: 3.9 cm H: 2 cm

#### Tip

350mA AMP plug included



Voltage sec.	3-9V
Output current	350mA
Wattage of	1W
Wattage up to	3W
Power factor	0,4
Thermal protection	110°C
Wattage-L sec. max.	2 m

Variant	Item No.
<input type="checkbox"/> white	464107

Manufacturer:  
WeiSen Electronic Co., Ltd

### LED DRIVER

350mA | 9W inc. strain relief

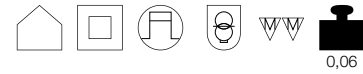

#### Product details

230V -50Hz  
Material: plastic PC  
L: 8.5 cm W: 4.1 cm H: 2.2 cm

Voltage sec.	3-26V
Output current	350mA
Wattage of	1W
Wattage up to	9W
Power factor	0,4
Thermal protection	110°C
Wattage-L sec. max.	2 m

Variant	Item No.
<input type="checkbox"/> white	464109

Manufacturer:  
WeiSen Electronic Co., Ltd

### LED DRIVER

350mA inc. strain relief

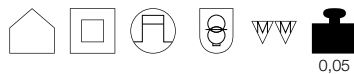

#### Product details

220-240V ~50/60Hz  
Material: plastic PC  
L: 15.8 cm W: 2.2 cm H: 1.9 cm

Output current	350mA
Number of outputs sec.	1
Wattage up to	15W
Power factor	0,6
Thermal protection	100°C

Variant	Item No.
<input type="checkbox"/> white	464031

Manufacturer:  
TCI Telecomunicazioni Italia Srl

### LED DRIVER

500mA | 9W inc. strain relief

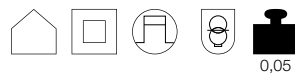

#### Product details

100-240V ~50/60Hz  
Material: plastic PC  
L: 6.5 cm W: 3.9 cm H: 2 cm

Voltage sec.	12-19V
Output current	500mA
Number of outputs sec.	1
Wattage of	6W
Wattage up to	9W
Power factor	0,9
Thermal protection	110°C
Wattage-L sec. max.	2 m

Variant	Item No.
<input type="checkbox"/> white	464091

Manufacturer:  
WeiSen Electronic Co., Ltd

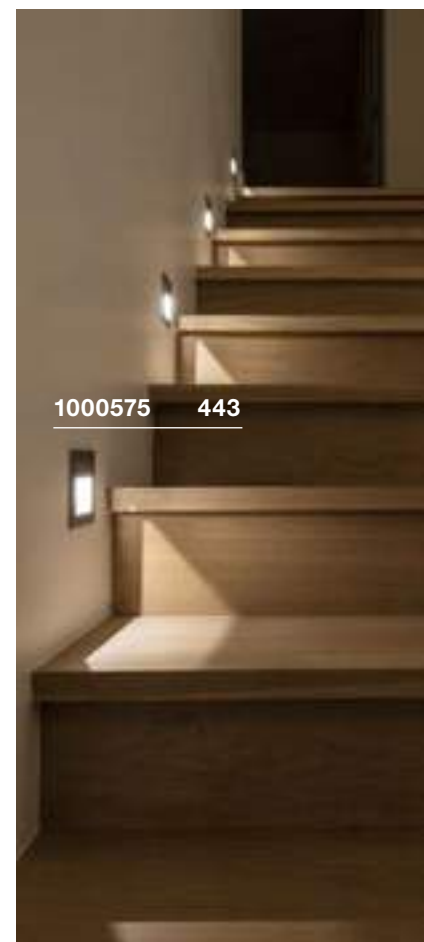

### LED DRIVER

700mA | 3W inc. strain relief



#### Product details

230V ~50Hz  
Material: plastic PC  
L: 5.5 cm W: 3.9 cm H: 2 cm

Voltage sec.	4-5V
Output current	700mA
Wattage up to	3W
Power factor	0,4
Thermal protection	110°C
Wattage-L sec. max.	2 m

Variant	Item No.
<input type="checkbox"/> white	<b>464200</b>

Manufacturer:  
WeiSen Electronic Co., Ltd

### LED DRIVER

700mA | 11W inc. strain relief

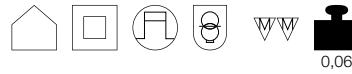

#### Product details

220-240V ~50/60Hz  
Material: plastic PC  
L: 15.5 cm W: 2.2 cm H: 1.9 cm

Output current	700mA
Wattage up to	11W
Power factor	0,6
Thermal protection	100°C

Variant	Item No.
<input type="checkbox"/> white	<b>464030</b>

Manufacturer:  
TCI Telecomunicazioni Italia Srl

### LED DRIVER

700mA | 40W inc. strain relief

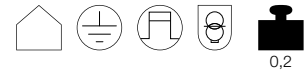

#### Product details

100-240V ~50/60Hz  
Material: plastic PC  
L: 12.9 cm W: 7.5 cm H: 3.2 cm

Voltage sec.	29-58V
Output current	700mA
Wattage of	20W
Wattage up to	40W
Power factor	0,9
Thermal protection	110°C
Wattage-L sec. max.	2 m

Variant	Item No.
<input checked="" type="checkbox"/> black	<b>464168</b>

Manufacturer:  
WeiSen Electronic Co., Ltd

### LED DRIVER VALETO®

1050mA | 45W inc. strain relief

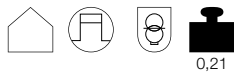

#### Product details

100-240V ~50/60Hz  
Material: plastic  
L: 19 cm W: 6.1 cm H: 3 cm

#### Tip

Remote control and dimming with gateway  
[1002411]

Voltage sec.	30-42V
Output current	1050mA
Number of outputs sec.	1
Wattage	42W
Wattage of	31.5W
Wattage up to	45W
Power factor	0,95
Thermal protection	110°C
Wattage-L sec. max.	2 m

Variant	Item No.
<input type="checkbox"/> white	<b>1001249</b>

### LED DRIVER

1000mA | 40W inc. strain relief

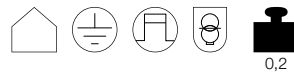

#### Product details

100-240V ~50/60Hz  
Material: plastic PC  
L: 12.9 cm W: 7.5 cm H: 3.2 cm

Voltage sec.	20-40V
Output current	1000mA
Number of outputs sec.	1
Wattage of	20W
Wattage up to	40W
Power factor	0,9
Thermal protection	110°C
Wattage-L sec. max.	2 m

Variant	Item No.
<input checked="" type="checkbox"/> black	<b>464170</b>

Manufacturer:  
WeiSen Electronic Co., Ltd



## CEILING HOOK



0,04

### Product details

Material: aluminium

Diameter: 1.8 cm L: 4.6 cm

Variant	Item No.
■ black	132670
□ white	132671

## CABLE CLAMP



0,01

### Product details

Material: aluminium

Diameter: 1.4 cm L: 3.1 cm

Variant	Item No.
■ black	132680
□ white	132681





## CEILING ROSE

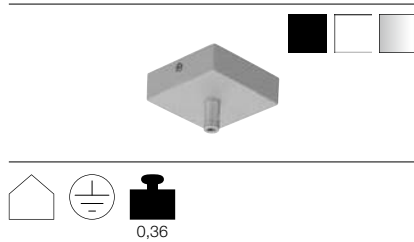

## Product details

230V -50Hz  
Material: aluminium  
L: 8.5 cm W: 8.5 cm H: 2.7 cm

Max. current load 8.5A

Variant	Item No.
■ black matt	210060
□ white matt	210061
■ silver	210064

TEXTILE CABLE  
3-pole, 3 x 0.75 mm<sup>2</sup>, 10m

## Product details

Max. voltage 300V  
Material: PVC  
Diameter: 0.6cm L: 1000 cm

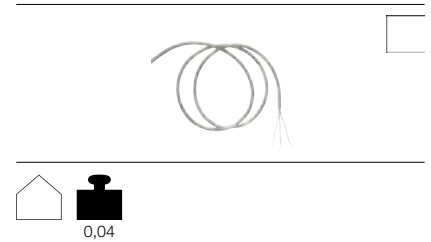
CABLE  
3-pole, 3x0.75mm<sup>2</sup>, 10m

## Product details

Max. voltage 300V  
L: 1000 cm

Variant	Item No.
□ transparent	961250

## WIRE ROPE SUSPENSION

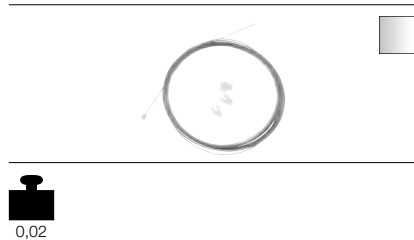

## Product details

Material: steel/plastic  
Diameter: 0.15cm L: 500 cm

mech. Max. load 40 kg

Variant	Item No.
■ silver	961037

Manufacturer:  
Reutlinger GmbH

## STOPPER FOR WIRE ROPE

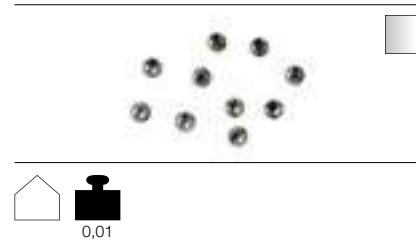

## Product details

Material: steel  
Diameter: 0.8 cm  
10 piece

Variant	Item No.
■ silver	961034



961276 841

### CONNECTOR STRIP

3 outlets



0,02

#### Product details

Material: plastic  
L: 5.2 cm W: 1.4 cm H: 1.3 cm

#### Tip

For 350mA plug-in system

### CABLE EXTENSION

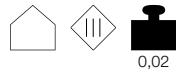

0,02

#### Product details

Material: plastic  
L: 100 cm

#### Tip

With AMP plug and socket  
For 350mA plug-in system

### GU10 SOCKET

with connection box and quick clamp



0,065

#### Product details

L: 27 cm

Variant	Item No.
■ black	111850

Variant	Item No.
	111861

Variant	Item No.
■ white/black	1000909

### GU10 SOCKET



0,02

#### Product details

230V -50Hz  
Material: ceramic  
L: 300 cm W: 0.9 cm

### DOUBLE-SIDED TAPE



#### Product details

L: 300 cm W: 0.9 cm

Variant	Item No.
□ white	955135

Variant	Item No.
□ clear	220000



CONNECTOR BOX



Product details

230V -50Hz  
Material: PA66 GF  
Diameter: 2.7 cm L: 11.5 cm

Tip

3-pole

Max. voltage	450V
Max. current load	17.5mA

Variant	Item No.
■ black	228730

CONNECTOR BOX



Product details

230V -50Hz  
Material: PA66 GF  
Diameter: 3.2 cm L: 13 cm

Tip

5-pole

Max. voltage	450V
Max. current load	32mA

Variant	Item No.
■ black	228725

T-CONNECTOR BOX

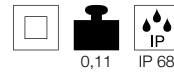

Product details

230V -50Hz  
Material: PA66  
L: 11 cm W: 6.4 cm H: 3 cm

Tip

3-pole

Max. voltage	500V
Max. current load	17.5mA

Variant	Item No.
■ black	228726



232295 605

# THE SOURCE OF ALL LIGHT.

## THE RIGHT LAMP FOR ANY LIGHTING SOLUTION.

---

The right lighting effect is the result of perfect interaction between the luminaire and the lamp. As well as the design, energy efficiency is also an important criterion. Many alternatives to the classic light bulb have gained a foothold on the market in recent years. This means that the right lighting element is available for every kind of application or luminaire.

## LAMPS

### GENERAL INFORMATION.

---

- Operating in open luminaires without protection glass is only permitted with low-pressure lamps. Lamps with this symbol (IEC 357 standard) are suitable for use in luminaires without protection glass.
- Halogen lamps and metal halide discharge lamps (HID) can cause the lamp housing to heat up. The latter may therefore only be touched when they have cooled down. Adjustable luminaires or lamp heads which do not have an adjusting handle fitted or which are used with lamps at the maximum wattage meaning that the maximum housing temperature permitted is exceeded on the obvious adjustment point, must be installed out of hands' reach. You can find corresponding solutions in this chapter.
- Low-voltage lamps can be operated using suitable LED retrofit lamps in many cases. However, not every combination of luminaires with apparently suitable lamps is possible due to the conflicting individual cases, where there are transformer and LED technology-specific issues. If you have any questions about compatibility, visit [slv.com](http://slv.com) or contact our sales department.
- The dimensions specified for the lamps always refer to the complete exterior dimensions of a lamp. This means that the threaded base is included.
- **All bulbs must be disposed of separately and do not belong in the household waste.**



LED QT14  
G9

15000 0,01

**Product details**

220-240V ~50/60Hz  
Wattage: 2.5W  
Diameter: 1.6 cm L: 4.8 cm

Lamp current	0.012A
Wattage	2.5W
Energy consumption/1000h	3kWh
Colour temperature	2700K
Luminous flux	180lm
Colour rendering index	>80

Variant	Item No.
	560302

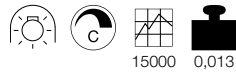
LED FILAMENT  
G9

15000 0,013

**Product details**

220-240V ~50/60Hz  
Wattage: 2.7 W  
Diameter: 1.4 cm L: 6.8 cm  
Dimmable: C

Lamp current	0.0135A
Wattage	2.7W
Energy consumption/1000h	3kWh
Colour temperature	2600K
Luminous flux	250lm
Colour rendering index	>90

Variant	Item No.
	1003102

Manufacturer: Segula GmbH

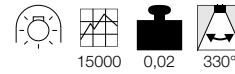
LED QT-DE12  
R7S 78mm

15000 0,02 330°

**Product details**

220-240V ~50/60Hz  
Wattage: 5.5W  
Diameter: 2.5 cm L: 7.8 cm

Lamp current	0.044A
Wattage	5.5W
Energy consumption/1000h	6kWh
Colour temperature	2700K
Luminous flux	530lm
Colour rendering index	>80

Variant	Item No.
	560332

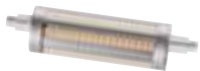
LED QT-DE12  
R7S 118mm

15000 0,09

**Product details**

220-240V ~50/60Hz  
Wattage: 14W  
Diameter: 2.9 cm L: 11.8 cm  
Dimmable: C, L

Lamp current	0.075A
Wattage	14W
Energy consumption/1000h	14kWh
Colour temperature	3000K
Luminous flux	2000lm
Colour rendering index	>80

Variant	Item No.
	1002135

Manufacturer: Signify B.V.

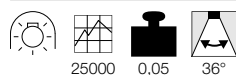
LED QR51  
GU5.3

25000 0,05 36°

**Product details**

12V AC  
Wattage: 5.5W  
Diameter: 5 cm H: 4.5 cm

**Tip**

Operate only with conventional transformer.

Lamp current	0.63A
Wattage	5.5W
Energy consumption/1000h	7kWh
max. luminosity	1000cd
Colour rendering index	>80

Variant	Item No.
2700K   450lm	1001574
3000K   460lm	1001575

Manufacturer: Signify B.V.



BIRGIT KÖNIG  
SCHNITTSTELLEN  
30.10.16 bis 15.01.17

139082 544

1001575 846

LED T32 FILAMENT  
GU10

## Product details

220-240V ~50/60Hz  
Wattage: 4W  
Diameter: 3.2 cm L: 10 cm  
Dimmable: C

Lamp current	0.02A
Wattage	4W
Energy consumption/1000h	4kWh
Colour temperature	2600K
Luminous flux	260lm
max. luminosity	700cd
Colour rendering index	>90

Variant	Item No.
	<b>1003101</b>

Manufacturer: Segula GmbH

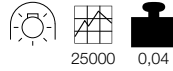
LED QPAR51  
GU10

## Product details

220-240V ~50/60Hz  
Diameter: 5 cm L: 5.4 cm

## Tip

Remote-controllable and dimmable with  
SLV VALETO® CCT/RGBW remote control  
[1002994] or Gateway [1002411]

Energy consumption/1000h	6kWh
Luminous flux	350lm
Colour rendering index	>80

Variant	Item No.
CCT   2700-6500K	
5.1W   48°	<b>1001918</b>
RGBW   5.6W   60°	<b>1001919</b>

LED QPAR51  
GU10

## Product details

220-240V ~50/60Hz  
Wattage: 3.7W  
Diameter: 5 cm H: 5.4 cm  
Dimmable: C, L

Lamp current	0.02A
Wattage	3.7W
Energy consumption/1000h	4kWh
Colour temperature	2700K
Luminous flux	260lm
max. luminosity	500cd
Colour rendering index	>90

Variant	Item No.
	<b>560122</b>

Manufacturer: Signify B.V.

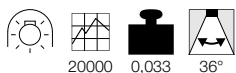
LED  
GU10

## Product details

220-240V ~50/60Hz  
Wattage: 4W  
Diameter: 5 cm H: 5.5 cm

## Tip

Contains recycled material

Lamp current	0.035A
Wattage	4W
Energy consumption/1000h	4kWh
Luminous flux	300lm
max. luminosity	400cd
Colour rendering index	>80

Variant	Item No.
2700K	<b>1004972</b>
3000K	<b>1004973</b>
4000K	<b>1004974</b>

LED  
GU10

## Product details

220-240V ~50/60Hz  
Wattage: 6W  
Diameter: 5 cm H: 5.4 cm  
Dimmable: C, L

Lamp current	0.037A
Wattage	6W
Energy consumption/1000h	6kWh
Colour temperature	2700K
Luminous flux	460lm
max. luminosity	830cd
Colour rendering index	>90

Variant	Item No.
Grey housing	<b>1005075</b>
White housing	<b>1005076</b>
Black housing	<b>1005077</b>

LED  
GU10

## Product details

220-240V ~50/60Hz  
Wattage: 6W  
Diameter: 5 cm H: 5.4 cm  
Dimmable: C, L

Lamp current	0.037A
Wattage	6W
Energy consumption/1000h	6kWh
Colour temperature	3000K
Luminous flux	460lm
max. luminosity	830cd
Colour rendering index	>90

Variant	Item No.
Grey housing	<b>1005078</b>
White housing	<b>1005079</b>
Black housing	<b>1005080</b>



LED  
GU10

NEW

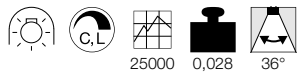

## Product details

220-240V ~50/60Hz  
Wattage: 6W  
Diameter: 5 cm H: 5.4 cm  
Dimmable: C, L

Lamp current	0.037A
Wattage	6W
Energy consumption/1000h	6kWh
Colour temperature	4000K
Luminous flux	460lm
max. luminosity	830cd
Colour rendering index	>90

Variant	Item No.
Grey housing	1005081
White housing	1005082
Black housing	1005083

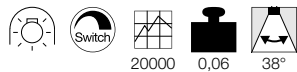
LED QPAR51  
GU10

## Product details

220-240V ~50/60Hz  
Wattage: 5,5W  
Diameter: 5 cm H: 5.5 cm  
Dimmable: switch

## Tip

3 dimming levels with normal wall switch.  
Switching the switch on and off causes  
the light to dim gradually.

Lamp current	0.038A
Wattage	5.5W
Energy consumption/1000h	6kWh
Colour temperature	2700K
Luminous flux	400lm
max. luminosity	700cd
Colour rendering index	>80

Variant	Item No.
	1001030

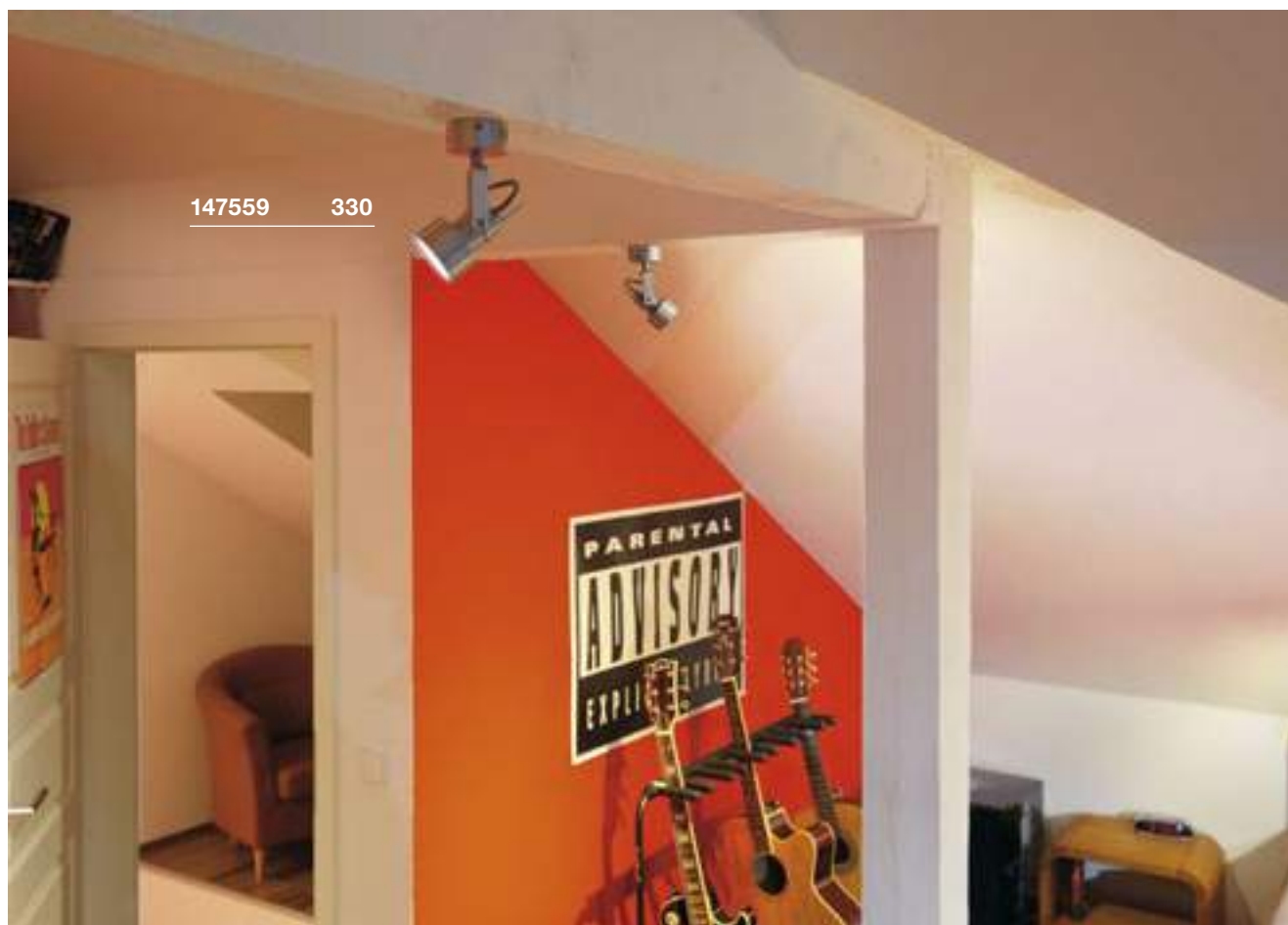

LED QPAR111  
GU10

## Product details

220-240V ~50/60Hz  
Wattage: 13W  
Diameter: 11 cm L: 7 cm  
Dimmable: C

Lamp current	0.052A
Wattage	13W
Energy consumption/1000h	13kWh
Colour rendering index	>90

Variant	Item No.
2700K   840lm	1003094
4000K   950lm	1003095

LED QPAR111  
GU10, CCT

## Product details

220-240V ~50/60Hz  
Wattage: 9W  
Diameter: 11.1 cm H: 7 cm

## Tip

Remote-controllable and dimmable with SLV VALETO® CCT/RGBW remote control [1002994] or Gateway [1002411]

Lamp current	0.048A
Wattage	9W
Energy consumption/1000h	9kWh
Colour temperature	2700K-6500K
Luminous flux	800lm
Colour rendering index	>80

Variant	Item No.
3300cd   25°	1001920
1900cd   40°	1001921

LED QPAR111  
GU10, RGBW

## Product details

220-240V ~50/60Hz  
Wattage: 9W  
Diameter: 11.1 cm H: 7 cm

## Tip

Remote-controllable and dimmable with SLV VALETO® CCT/RGBW remote control [1002994] or Gateway [1002411]

Lamp current	0.048A
Wattage	9W
Energy consumption/1000h	9kWh
Colour temperature	RGBW
Luminous flux	800lm
max. luminosity	3700cd
Colour rendering index	>80

Variant	Item No.
25°	1001922
40°	1001923

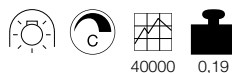
LED QPAR111  
GU10

## Product details

230V -50Hz  
Wattage: 13W  
Diameter: 11.1 cm H: 7.1 cm  
Dimmable: C

Lamp current	0.052A
Wattage	13W
Energy consumption/1000h	13kWh
Colour temperature	2700K
Colour rendering index	>80

Variant	Item No.
1100lm   30°	1001242
1000lm   140°	1001244

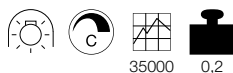
LED QPAR111  
GU10

## Product details

220-240V ~50/60Hz  
Wattage: 13W  
Diameter: 11 cm H: 7.1 cm  
Dimmable: C

Lamp current	0.052A
Wattage	13W
Energy consumption/1000h	13kWh
Colour temperature	4000K
Colour rendering index	>90

Variant	Item No.
1100lm   30°	1003087
1000lm   140°	1003088

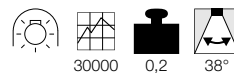
LED QPAR111  
GU10

## Product details

220-240V ~50/60Hz  
Wattage: 6.5W  
Diameter: 11 cm H: 7 cm

Lamp current	0.046A
Wattage	6.5W
Energy consumption/1000h	7kWh
Colour temperature	2700K
Luminous flux	390lm
max. luminosity	785cd
Colour rendering index	>80

Variant	Item No.
	551882

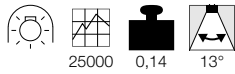
LED QPAR111  
GU10

25000 0,14 13°

## Product details

220-240V ~50/60Hz  
Diameter: 11.1 cm H: 7.3 cm

Energy consumption/1000h	8kWh
Luminous flux	730lm
max. luminosity	5600cd
Colour rendering index	>80

Variant	Item No.
2700K   7.3W   0.069A	<b>1000939</b>
3000K   7W   0.04A	<b>1001568</b>
4000K   7.3W   0.069A	<b>1000940</b>

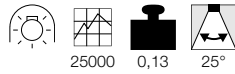
LED QPAR111  
GU10

25000 0,13 25°

## Product details

220-240V ~50/60Hz  
Diameter: 11.1 cm

Energy consumption/1000h	8kWh
Colour rendering index	>80

Variant	Item No.
2700K   730lm   7.9W   0.039A   1900cd	
H: 7 cm	<b>560702</b>
3000K   730lm   7W   0.04A   1800cd	
H: 7.3 cm	<b>1001570</b>
4000K   760lm   7.9W   0.04A   1800cd	
H: 7 cm	<b>560704</b>

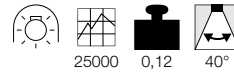
LED QPAR111  
GU10

25000 0,12 40°

## Product details

220-240V ~50/60Hz  
Diameter: 11.1 cm

Energy consumption/1000h	8kWh
Colour rendering index	>80

Variant	Item No.
2700K   730lm   7,9W   0,039A   1800cd	
0.13 kg   H: 7 cm	<b>560722</b>
3000K   730lm   7W   0.04A   870cd	
0.14 kg   H: 7.3 cm	<b>1001572</b>
4000K   760lm   7.9W   0.039A   920cd	
0.12 kg   H: 7 cm	<b>560724</b>

LED QR111  
G53

40000 0,17

## Product details

12V AC  
Wattage: 15W  
Diameter: 11.1 cm H: 6.2 cm

Lamp current	1.8A
Wattage	15W
Energy consumption/1000h	17kWh
Colour temperature	2700K
Colour rendering index	>90

Variant	Item No.
760lm   3900cd   24°	<b>560231</b>
750lm   1400cd   40°	<b>560232</b>

Manufacturer: Signify B.V.

LED QR111  
G53

40000 0,17

## Product details

12V AC  
Wattage: 15W  
Diameter: 11.1 cm H: 6.2 cm

Lamp current	1.8A
Wattage	15W
Energy consumption/1000h	17kWh
Colour temperature	3000K
Colour rendering index	>90

Variant	Item No.
770lm   4000cd   24°	<b>560233</b>
760lm   1450cd   40°	<b>560234</b>

Manufacturer: Signify B.V.

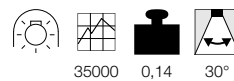
LED QR111  
G53

35000 0,14 30°

## Product details

12V AC  
Wattage: 19.5 W  
Diameter: 11 cm H: 6.1 cm

Lamp current	1.85A
Wattage	19.5W
Energy consumption/1000h	21kWh
Colour temperature	2700K
max. luminosity	1625cd
Luminous flux	1070lm
max. luminosity	1625cd
Colour rendering index	>80

Variant	Item No.
	<b>551402</b> ▼

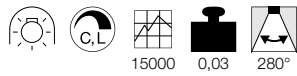
LED C35  
E14

## Product details

220-240V ~50/60Hz  
Performance: 4.5 W  
Diameter: 3.5 cm H: 12.1 cm  
Dimmable: C, L

Lamp current	0.022A
Wattage	4.5W
Energy consumption/1000h	5kWh
Colour temperature	2700K
Luminous flux	490lm
Colour rendering index	>80

Variant	Item No.
	1002128

LED C35  
E14

## Product details

220-240V ~50/60Hz  
Wattage: 6.5W  
Diameter: 3.8 cm H: 11 cm  
Dimmable: C, L

Lamp current	0.033A
Wattage	6.5W
Energy consumption/1000h	7kWh
Colour temperature	2700K
Luminous flux	480lm
Colour rendering index	>80

Variant	Item No.
	560372

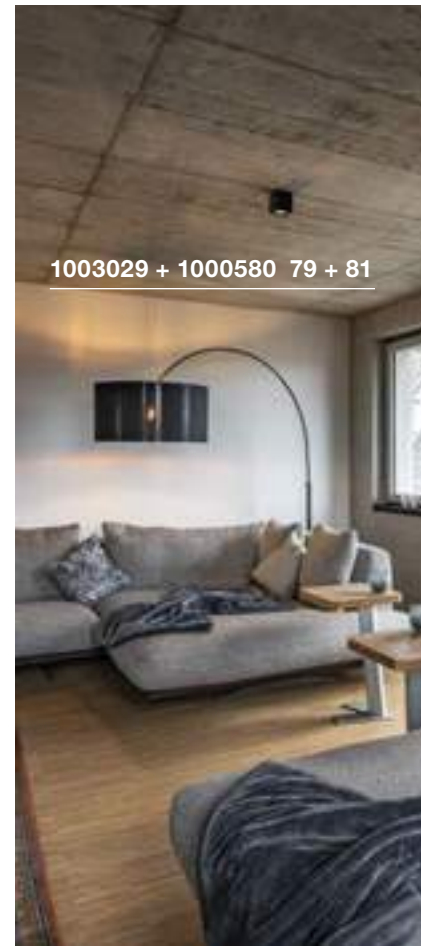

1003029 + 1000580 79 + 81

LED A60  
E27, CCT

## Product details

220-240V ~50/60Hz  
Wattage: 9W  
Diameter: 6 cm H: 12 cm

## Tip

Remote-controllable and dimmable with SLV VALETO® CCT/RGBW remote control [1002994] or Gateway [1002411]

Lamp current	0.052A
Wattage	9W
Energy consumption/1000h	9kWh
Colour temperature	2700K-6500K
Luminous flux	806lm
Colour rendering index	>80

Variant	Item No.
	1001916

LED A60  
E27, RGBW

## Product details

220-240V ~50/60Hz  
Wattage: 9.5W  
Diameter: 6 cm H: 12 cm

## Tip

Remote-controllable and dimmable with SLV VALETO® CCT/RGBW remote control [1002994] or Gateway [1002411]

Lamp current	0.054A
Wattage	9.5W
Energy consumption/1000h	10kWh
Colour temperature	RGBW
Luminous flux	806lm
Colour rendering index	>80

Variant	Item No.
	1001917

LED A60  
E27

## Product details

220-240V ~50/60Hz  
Wattage: 9.1W  
Diameter: 6 cm H: 11 cm  
Dimmable: C, L

Lamp current	0.043A
Wattage	9.1W
Energy consumption/1000h	10kWh
Colour temperature	2700K
Luminous flux	760lm
Colour rendering index	>80

Variant	Item No.
	560402



**LED A60**  
E27



**Product details**

220-240V ~50/60Hz  
Wattage: 14.5W  
Diameter: 6 cm H: 12.2 cm  
Dimmable: C, L

Lamp current	0.064A
Wattage	14.5W
Energy consumption/1000h	15kWh
Colour temperature	2700K
Luminous flux	1521lm
Colour rendering index	>80

Variant	Item No.
	560422

**LED A60**  
E27

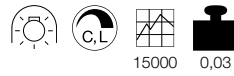

**Product details**

220-240V ~50/60Hz  
Wattage: 7W  
Diameter: 6 cm L: 10.5 cm  
Dimmable: C, L

Lamp current	0.032A
Wattage	7W
Energy consumption/1000h	7kWh
Colour temperature	2700K
Luminous flux	810lm
Colour rendering index	>80

Variant	Item No.
	1003090

**LED T38**  
E27

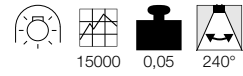

**Product details**

100-240V ~50/60Hz  
Wattage: 9W  
Diameter: 3.8 cm H: 11.5 cm

Lamp current	0.046A
Wattage	9W
Energy consumption/1000h	10kWh
Colour rendering index	>80

Variant	Item No.
3000K   810lm	1001031
4000K   850lm	1002827

**LED T45**  
E27

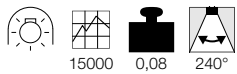

**Product details**

100-240V ~50/60Hz  
Wattage: 15W  
Diameter: 4.5 cm H: 13.6 cm

Lamp current	0.063A
Wattage	15W
Energy consumption/1000h	15kWh
Colour rendering index	>80

Variant	Item No.
3000K   1521lm	1001033
4000K   1600lm	1002828

Manufacturer: GE Lighting GmbH



229021 571

LED FRISBEE  
E27

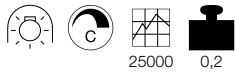

Product details

220-240V ~50/60Hz  
Wattage: 10.5W  
Diameter: 19.2 cm L: 11.8 cm  
Dimmable: C

Lamp current	0.055A
Wattage	10.5W
Energy consumption/1000h	10.5kWh
Colour temperature	2700K
Luminous flux	1000lm
Colour rendering index	>80

Variant	Item No.
	1003093

LED A60  
E27



Product details

220-240V ~50/60Hz  
Wattage: 7W  
Diameter: 6 cm H: 10.5 cm  
Dimmable: C, L

Lamp current	0.031A
Wattage	7W
Energy consumption/1000h	7kWh
Colour temperature	2700K
Luminous flux	790lm
Colour rendering index	>80

Variant	Item No.
	1002124

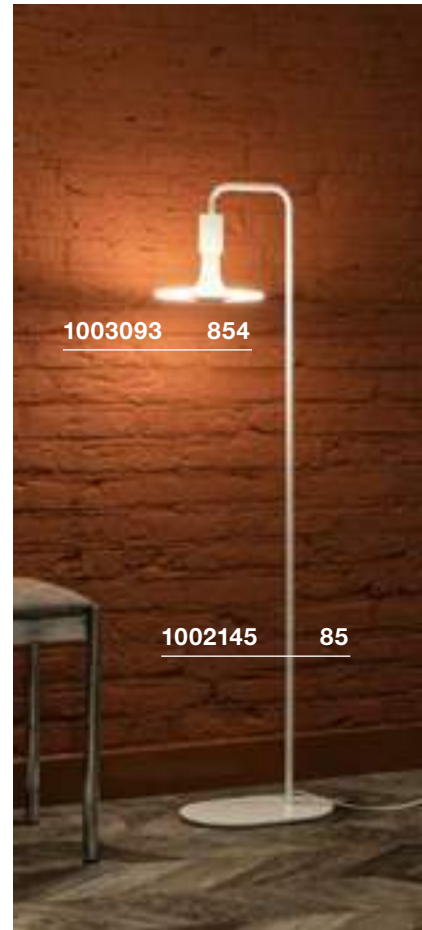

LED A60  
E27

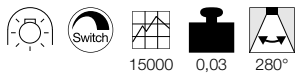

Product details

220-240V ~50/60Hz  
Wattage: 7W  
Diameter: 6 cm H: 10.5 cm  
Dimmable: switch

Tip

3 dimming levels with normal wall switch.  
Switching the switch on and off causes the light to dim gradually.

Lamp current	0.053A
Wattage	7W
Energy consumption/1000h	7kWh
Colour temperature	2700K
Luminous flux	790lm
Colour rendering index	>80

Variant	Item No.
	1002127

LED A60  
E27

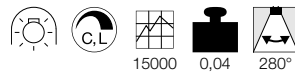

Product details

220-240V ~50/60Hz  
Wattage: 7W  
Diameter: 6 cm H: 11.4 cm  
Dimmable: C, L

Lamp current	0.031A
Wattage	7W
Energy consumption/1000h	7kWh
Colour temperature	2200-2700K
Luminous flux	830lm
Colour rendering index	>80

Variant	Item No.
	1002126

LED A60  
E27

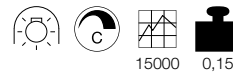

Product details

220-240V ~50/60Hz  
Wattage: 15W  
Diameter: 9 cm L: 23 cm  
Dimmable: C

Lamp current	0.09A
Wattage	15W
Energy consumption/1000h	15kWh
Colour temperature	2700K
Luminous flux	1600lm
Colour rendering index	>90

Variant	Item No.
	1003097

Manufacturer: Segula GmbH



**LED ST58**  
E27

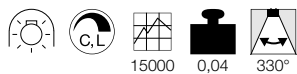

**Product details**

220-240V ~50/60Hz  
Wattage: 7.1W  
Diameter: 5.8 cm H: 12.8 cm  
Dimmable: C, L

Lamp current	0.035A
Wattage	7.1W
Energy consumption/1000h	8kWh
Colour temperature	2700K
Luminous flux	806lm
Colour rendering index	>80

Variant	Item No.
	1001756

**LED ST64**  
E27

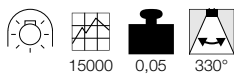

**Product details**

220-240V ~50/60Hz  
Wattage: 5W  
Diameter: 6.4 cm H: 14.5 cm

Lamp current	0.043A
Wattage	5W
Energy consumption/1000h	5kWh
Colour temperature	2000K
Luminous flux	500lm
Colour rendering index	>80

Variant	Item No.
	560741

**LED T32**  
E27



**Product details**

220-240V ~50/60Hz  
Wattage: 8W  
Diameter: 3.2 cm H: 18.5 cm  
Dimmable: C

Lamp current	0.03A
Wattage	8W
Energy consumption/1000h	8kWh
Colour temperature	2200K
Luminous flux	250lm
Colour rendering index	>95

Variant	Item No.
	1003100

Manufacturer: Segula GmbH

**LED A60**  
E27, Mirrorhead, Chrome

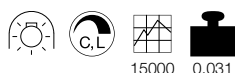

**Product details**

220-240V ~50/60Hz  
Wattage: 7W  
Diameter: 6 cm H: 10.5 cm  
Dimmable: C, L

Lamp current	0.032A
Wattage	7W
Energy consumption/1000h	7kWh
Colour temperature	2700K
Luminous flux	640lm
Colour rendering index	>80

Variant	Item No.
	1003085

**LED A60**  
E27, Mirrorhead, Gold



**Product details**

220-240V ~50/60Hz  
Wattage: 4W  
Diameter: 6 cm L: 10.6 cm  
Dimmable: C

Lamp current	0.02A
Wattage	4W
Energy consumption/1000h	4kWh
Colour temperature	2000-2900K
Luminous flux	200lm
Colour rendering index	>90

Variant	Item No.
	1003098

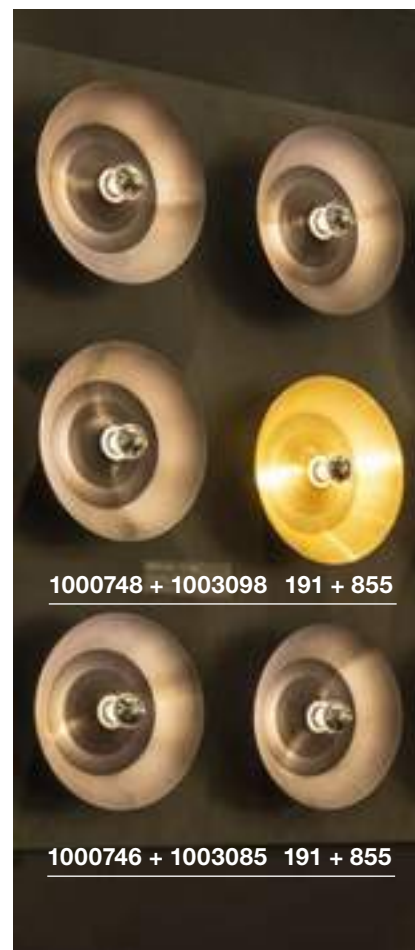

LED G95/G125  
E27

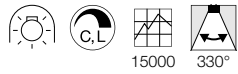

Product details

220-240V ~50/60Hz  
Wattage: 7W  
Dimmable: C, L

Lamp current	0.043A
Wattage	7W
Energy consumption/1000h	8kWh
Colour temperature	2700K
Luminous flux	806lm
Colour rendering index	>80

Variant	Item No.
Diameter: 9.5 cm   H: 13.2 cm 0.06 kg	<b>1001035</b>
Diameter: 12.5 cm   H: 17.8 cm 0.1 kg	<b>1001038</b>

LED G95/G125  
E27, Smoked glass



Product details

220-240V ~50/60Hz  
Wattage: 7W  
Dimmable: C

Lamp current	0.032A
Wattage	7W
Energy consumption/1000h	7kWh
Colour temperature	2700K
Colour rendering index	>80

Variant	Item No.
360lm   Diameter: 9.5 cm   H: 13.5 cm 0.054 kg	<b>1003091</b>
440lm   Diameter: 12.4 cm   H: 16.8 cm 0.124 kg	<b>1003092</b>

LED G125  
E27



Product details

220-240V ~50/60Hz  
Wattage: 7W  
Diameter: 12.5 cm H: 17.8 cm  
Dimmable: C, L

Lamp current	0.043A
Wattage	7W
Energy consumption/1000h	8kWh
Colour temperature	2700K
Luminous flux	630lm
Colour rendering index	>80

Variant	Item No.
	<b>1001357</b>

LED G125  
E27, Mirrorhead, gold

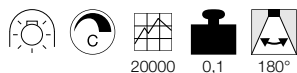

Product details

220-240V ~50/60Hz  
Wattage: 8W  
Diameter: 12.5 cm H: 17.8 cm  
Dimmable: C

Lamp current	0.04A
Wattage	8W
Energy consumption/1000h	8kWh
Colour temperature	2000-2900K
Luminous flux	400lm
Colour rendering index	>90

Variant	Item No.
	<b>1003099</b>

Manufacturer: Segula GmbH

LED G125  
E27, Smoked glass

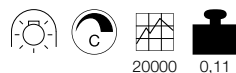

Product details

220-240V ~50/60Hz  
Wattage: 8W  
Diameter: 12.5 cm H: 17.8 cm  
Dimmable: C

Lamp current	0.032A
Wattage	8W
Energy consumption/1000h	8kWh
Colour temperature	2000-2900K
Luminous flux	500lm
Colour rendering index	>90

Variant	Item No.
	<b>1003096</b>

Manufacturer: Segula GmbH







LED PAR38  
E27

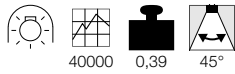

Product details

220-240V ~50/60Hz  
Wattage: 17W  
Diameter: 12.2 cm H: 13.5 cm

Lamp current	0.079A
Wattage	17W
Energy consumption/1000h	17kWh
Colour temperature	3000K
Luminous flux	1430lm
max. luminosity	1630cd
Colour rendering index	>80

Variant	Item No.
	560473

LED TCR-TSE  
GX53

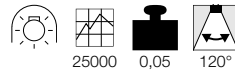

Product details

230V -50Hz  
Wattage: 3W  
Diameter: 7.6 cm H: 2.6 cm

Lamp current	0.03A
Wattage	3W
Energy consumption/1000h	3kWh
Colour temperature	3000K
Luminous flux	250lm
Colour rendering index	>80

Variant	Item No.
	551372

LED TCR-TSE  
GX53

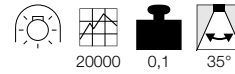

Product details

230V -50Hz  
Wattage: 4.2W  
Diameter: 7.5 cm H: 3.5 cm

Lamp current	0.041A
Wattage	4.2W
Energy consumption/1000h	5kWh
Colour temperature	3000K
Luminous flux	200lm
max. luminosity	550cd
Colour rendering index	>80

Variant	Item No.
	550092

LED TCR-TSE  
GX53

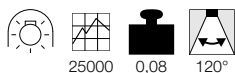

Product details

220-240V ~50/60Hz  
Wattage: 8.2W  
Diameter: 7.5 cm H: 2.9 cm

Lamp current	0.062A
Wattage	8.2W
Energy consumption/1000h	9kWh
Colour rendering index	>80

Variant	Item No.
3000K   600lm	550073
4000K   620lm	550074

T16  
G5

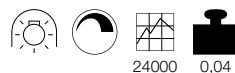

Product details

220-240V ~50/60Hz  
Wattage: 14W  
Diameter: 1.6 cm H: 54.9 cm

Wattage	14W
Energy consumption/1000h	9kWh
Colour temperature	3000K
Luminous flux	1200lm
Colour rendering index	>85

Variant	Item No.
	548014 ▼

Manufacturer: Feilo Sylvania Germany GmbH

T16  
G5

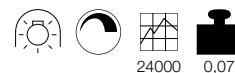

Product details

220-240V ~50/60Hz  
Wattage: 21W  
Diameter: 1.6 cm H: 85 cm

Wattage	21W
Energy consumption/1000h	9kWh
Colour temperature	3000K
Luminous flux	1900lm
Colour rendering index	>85

Variant	Item No.
	548021 ▼

Manufacturer: Feilo Sylvania Germany GmbH



1004682 + 132650 200 + 94

# IT'S A FAMILY AFFAIR:

OUR SLV LUMINAIRE FAMILIES.



Particularly when visual continuity is required, our range of luminaires is ideal for designing different rooms or room situations in a uniform way, yet still remain versatile.

## ABRIDOR

Paths/position



604

Paths/position



604

Wall



664

Wall



664

## ACCANTO

Pendant



139

Wall



246

Wall



247

Ceiling



284



**AIXLIGHT®**

Installation	Installation	Installation	Installation	Installation	Installation	Installation
438	438	439	438	438	439	439

**AIXLIGHT® R2**

Pendant	Pendant	Pendant	Pendant
173	174	174	174

**ALTRA DICE**

Wall	Wall/ceiling	1-circuit track	3-circuit track
316	316	479	517

**ANELA**

Pendant	Wall/display	Ceiling
130	275	313

**APONI**

Paths/position	Paths/position	Wall
577	577	645

**ASTINA**

Pendant	Wall	Ceiling	Wall	Wall	Wall
123	232	312	680	681	681

**AVO**

Wall/ceiling	Wall/ceiling	Wall/ceiling	Wall/ceiling	3-circuit track	1-circuit track
345	345	345	345	478	511



**BATO**

Pendant  	Pendant  	Pendant  	Pendant  
<b>116</b>	<b>116</b>	<b>116</b>	<b>117</b>

---

Wall  	Wall  	Ceiling  	Ceiling  
<b>191</b>	<b>191</b>	<b>286</b>	<b>286</b>

**BENDO**



Paths/position 	Paths/position 	Wall 
<b>602</b>	<b>602</b>	<b>662</b>

**BIG NAILS**

Paths/position 	Paths/position 	Paths/position 	Wall 
<b>579</b>	<b>580</b>	<b>580</b>	<b>647</b>

**BIG THEO**

Wall  	Wall  	Ceiling  
<b>676</b>	<b>693</b>	<b>709</b>

**BIG THEO LED**

Wall  	Wall  	Wall  	Ceiling  
<b>677</b>	<b>694</b>	<b>695</b>	<b>709</b>

**BIMA**

3-circuit track  	3-circuit track  	1-circuit track  	1-circuit track  	Easytec® II  	Easytec® II  
<b>485</b>	<b>485</b>	<b>515</b>	<b>515</b>	<b>535</b>	<b>535</b>



C-POL



ENOLA



ENOLA B



ENOLA C

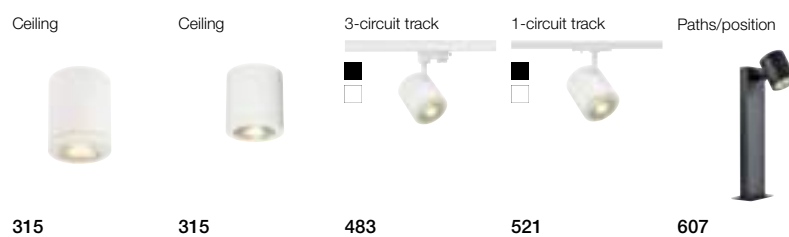



ESKINA

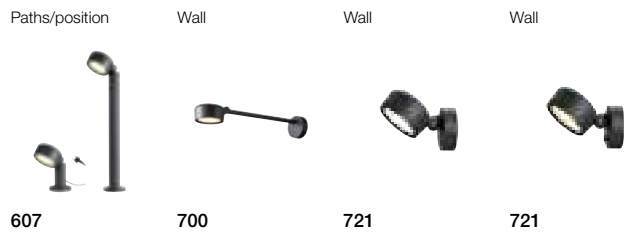

ESKINA FRAME



EURO SPOT

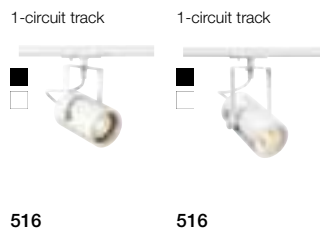
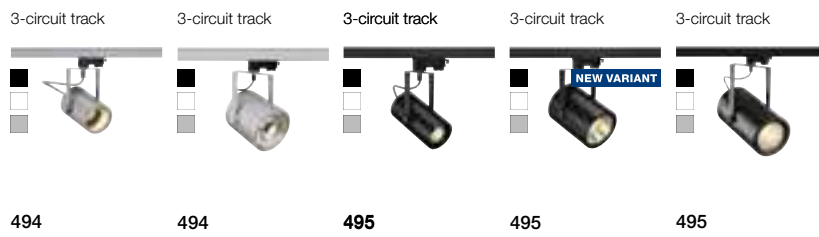

FENDA  
MIX & MATCH

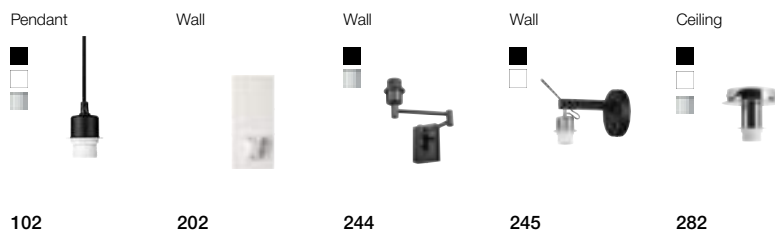
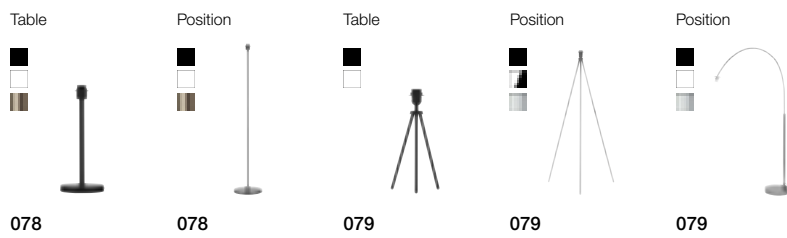



**FITU**  
MIX & MATCH

<p>Position</p> <p><b>070</b></p>	<p>Position</p> <p><b>085</b></p>	<p>Pendant</p> <p><b>094</b></p>	<p>Pendant</p> <p><b>095</b></p>		
<p>Pendant</p> <p><b>096</b></p>	<p>Pendant</p> <p><b>097</b></p>	<p>Wall</p> <p><b>196</b></p>	<p>Wall/ceiling</p> <p><b>200</b></p>	<p>Wall/ceiling</p> <p><b>200</b></p>	<p>Wall/ceiling</p> <p><b>333</b></p>

**FLATT**

<p>Paths/position</p> <p><b>599</b></p>	<p>Wall</p> <p><b>665</b></p>	<p>Wall</p> <p><b>665</b></p>
---	-------------------------------	-------------------------------

**FORCHINI**

<p>Pendant</p> <p><b>118</b></p>	<p>Pendant</p> <p><b>118</b></p>	<p>Pendant</p> <p><b>119</b></p>	<p>Pendant</p> <p><b>119</b></p>	<p>3-circuit track</p> <p><b>499</b></p>	<p>1-circuit track</p> <p><b>525</b></p>
----------------------------------	----------------------------------	----------------------------------	----------------------------------	--	--

**F-POL**

<p>Paths/position</p> <p><b>583</b></p>	<p>Wall</p> <p><b>646</b></p>
---	-------------------------------

**GLOO PURE**

<p>Paths/position</p> <p><b>574</b></p>	<p>Wall/ceiling</p> <p><b>642</b></p>
---	---------------------------------------

**GRAPHITE**

<p>Paths/position</p> <p><b>586</b></p>	<p>Wall</p> <p><b>648</b></p>
---	-------------------------------





HELIA

Pendant  126	Pendant  126	Pendant  127	Pendant  127	Pendant  128	Pendant  129
Wall/ceiling  339	Wall/ceiling  339	Installation  391	3-circuit track  482	1-circuit track  521	
Paths/position  610	Paths/position  610	Paths/position  611	Paths/position  613	Paths/position  613	
Spotlight  631	Spotlight  631	Wall  723	Wall  723		

IPERI

Paths/position  605	Wall  668				
--	--	--	--	--	--

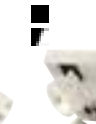
KALU LED

Wall/ceiling  352	Wall/ceiling  352	Wall/ceiling  352	Wall/ceiling  353		
3-circuit track  493	3-circuit track  493	1-circuit track  519			





**KALU  
QPAR111**

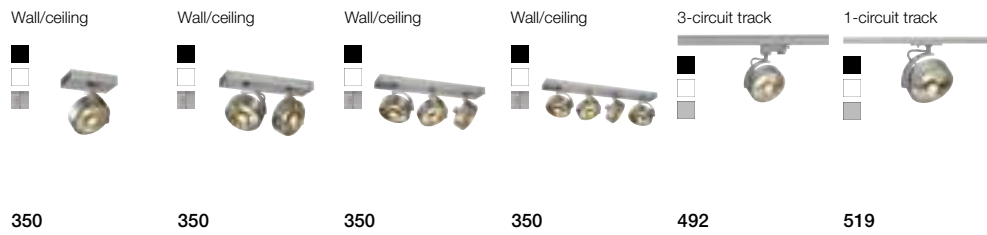

**KALU  
QR111**



**KARPO**

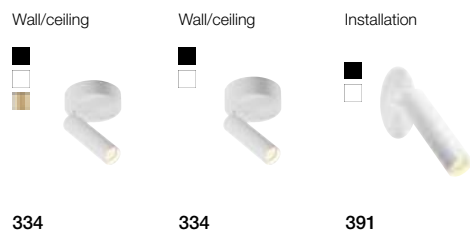

**LED SAIL**

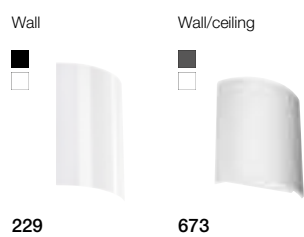

**LENITO**

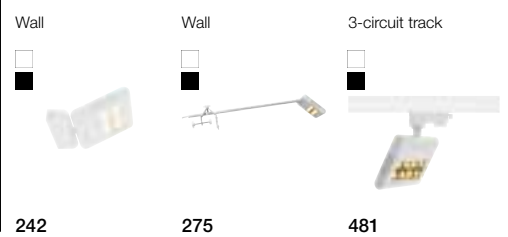

**LIGHT EYE 150**

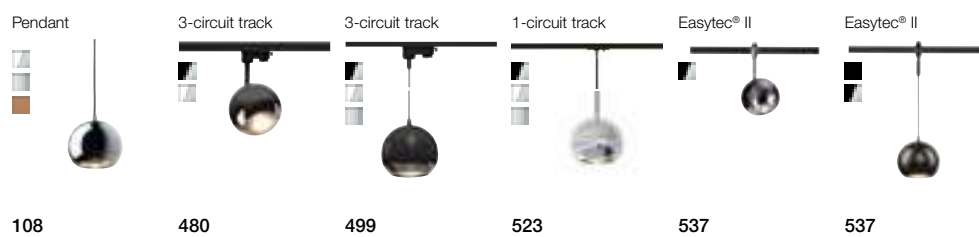

**LIGHT EYE 90**

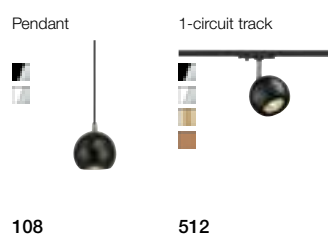



LISENNE

Pendant	Wall	Paths/position	Paths/position
131	197	572	572

L-LINE

Paths/position	Paths/position	Paths/position	Wall
<b>NEW</b>	<b>NEW</b>	<b>NEW</b>	<b>NEW</b>
595	595	595	688

LOGS

Wall	Wall	Wall	Wall	Paths/position	Paths/position	Wall
212	212	213	213	586	586	692

MAGANDA

Table	Wall
<b>FOLLOWER</b>	<b>FOLLOWER</b>
072	260

MALU

Position	Wall/ceiling	Wall/ceiling
606	670	711

MANA

















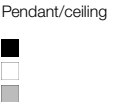

Wall	Wall	Wall	Wall	Wall	Shade	Shade
<b>NEW</b>	<b>NEW</b>	<b>NEW</b>	<b>NEW</b>			
192	192	193	193	204	205	205



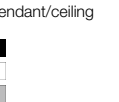

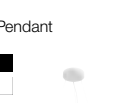

Wall	Wall	Shade	Shade	Wall
206	206	207	207	688



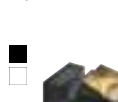

**MEDO LED**

Pendant/ceiling  144, 294	Pendant/ceiling  145, 295	Pendant/ceiling  146, 296	Pendant/ceiling  146, 296	Pendant/ceiling  146, 296	Pendant/ceiling  147, 297	Pendant/ceiling  148, 298
Pendant/ceiling  149, 299	Pendant/ceiling  149, 299	Pendant/ceiling  149, 299	Pendant/ceiling  150, 300	Pendant/ceiling  150, 300	Pendant/ceiling  150, 300	Pendant/ceiling  151, 301
Pendant/ceiling  152, 302	Pendant/ceiling  153, 303	Pendant  154	Pendant  154	Pendant  155	Installation  454, 455	Installation  456, 457

**MERADO FLOOD**

Wall  243	3-circuit track  481	<b>MOLAT</b>	Pendant  563	Paths/position  578	Wall  642	Ceiling  702
--	---	--------------	---	--	--	---

**MYRA**

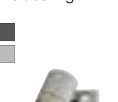
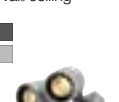
Paths/position  613	Wall  679	Wall  701	Wall/ceiling  722	Wall/ceiling  722
--	--	--	--	--

**NAUTILUS**

Spike  618	Spike  618	Spike  620	Spike  621	Spotlight  627	Spotlight  629	Spotlight  629
Spotlight  629	Wall/ceiling  720	Wall/ceiling  720	Wall/ceiling  720			





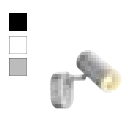
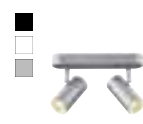
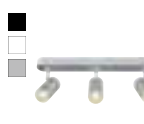
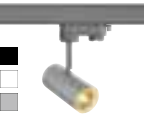
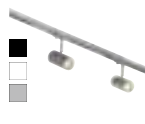
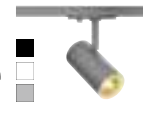
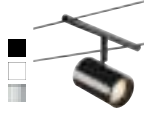

**NOBLO**

<p>Wall/ceiling</p>  <p>343</p>	<p>Wall/ceiling</p>  <p>343</p>	<p>Wall/ceiling</p>  <p>343</p>	<p>3-circuit track</p>  <p>482</p>
<p>1-circuit track</p>  <p>510</p>	<p>1-circuit track</p>  <p>520</p>	<p>Low-voltage cable system</p>  <p>550</p>	





**NUMINOS**

<p>Installation</p>  <p>026</p>	<p>Installation</p>  <p>028</p>	<p>Installation</p>  <p>030</p>	<p>Installation</p>  <p>032</p>	<p>Installation</p>  <p>034</p>	<p>Installation</p>  <p>036</p>	<p>Installation</p>  <p>038</p>
<p>3-circuit track</p>  <p>042</p>	<p>3-circuit track</p>  <p>044</p>	<p>3-circuit track</p>  <p>046</p>	<p>Wall/ceiling</p>  <p>048</p>	<p>Ceiling</p>  <p>050</p>	<p>Ceiling</p>  <p>052</p>	
<p>Ceiling</p>  <p>054</p>	<p>Ceiling</p>  <p>056</p>	<p>Ceiling</p>  <p>058</p>	<p>Pendant</p>  <p>060</p>	<p>Pendant</p>  <p>062</p>	<p>Pendant</p>  <p>064</p>	

**OCCULDAS**  
Design:  
David Morgan

<p>Ceiling</p>  <p>311</p>	<p>Ceiling</p>  <p>311</p>	<p>Installation</p>  <p>411</p>	<p>Installation</p>  <p>411</p>
---	---	--	--

**OCULUS**

<p>Installation</p>  <p>107</p>	<p>Wall</p>  <p>233</p>	<p>Ceiling</p>  <p>315</p>	<p>Wall/ceiling</p>  <p>331</p>	<p>Installation</p>  <p>445</p>
--	--	---	--	---



ONE

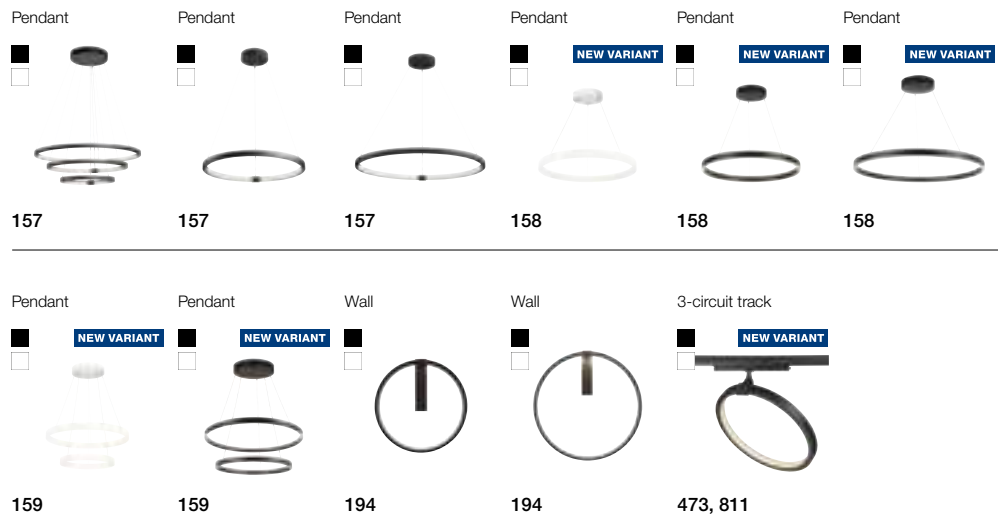

OVALISK



PARA CONE



PHELIA  
Design:  
Markus Becker



PHOTONIA









PLASTRA

Pendant  106	Pendant  124	Wall  190	Wall  190	Wall  208	Wall  209	Wall  210
Wall  211	Wall  215	Wall  215	Wall  227	Wall  230	Wall  231	Wall  236
Wall  236	Ceiling  288	Ceiling  288	Ceiling  288	Ceiling  322	Installation  394	Installation  395







P-LIGHT

Wall/ceiling  372	Wall/ceiling  373	Wall/ceiling  375	Installation  405
--	--	--	--

POLE PARC

Paths/position  584	Paths/position  584	Paths/position  584	Wall  657	Wall  683	Ceiling  706
--	--	--	--	---	---

PURI

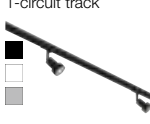
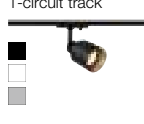
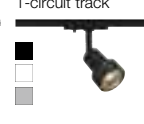
Wall/ceiling  349	Wall/ceiling  349	Wall/ceiling  349	Wall/ceiling  349	3-circuit track  484	3-circuit track  485
1-circuit track  510	1-circuit track  511	1-circuit track  512			



**Q-LINE**

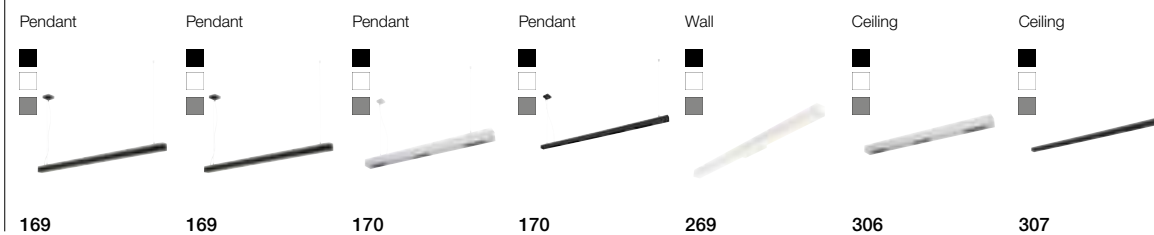

**QUAD**

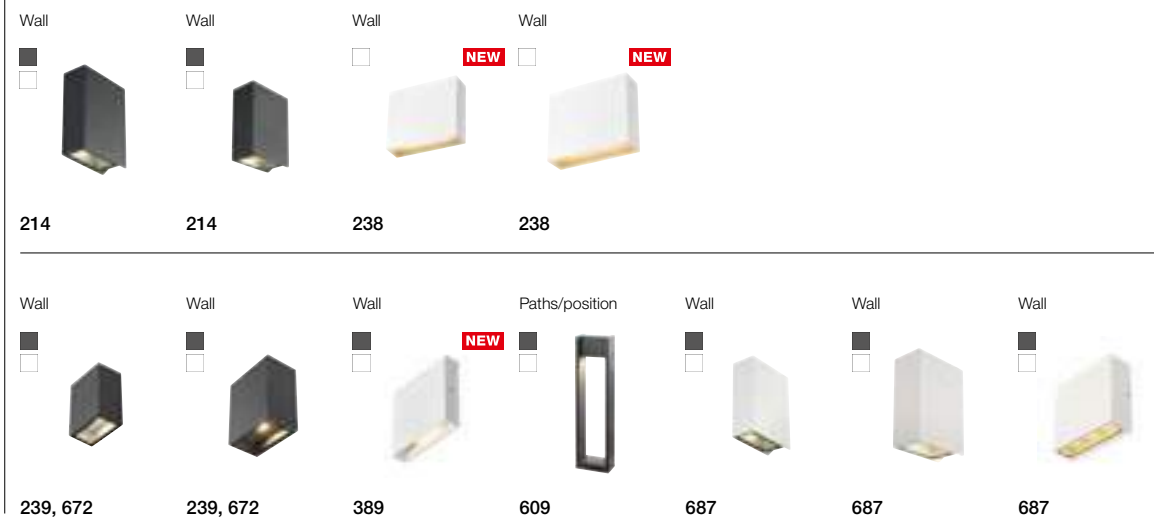

**QUADRASYL**



**ROTOBALL**

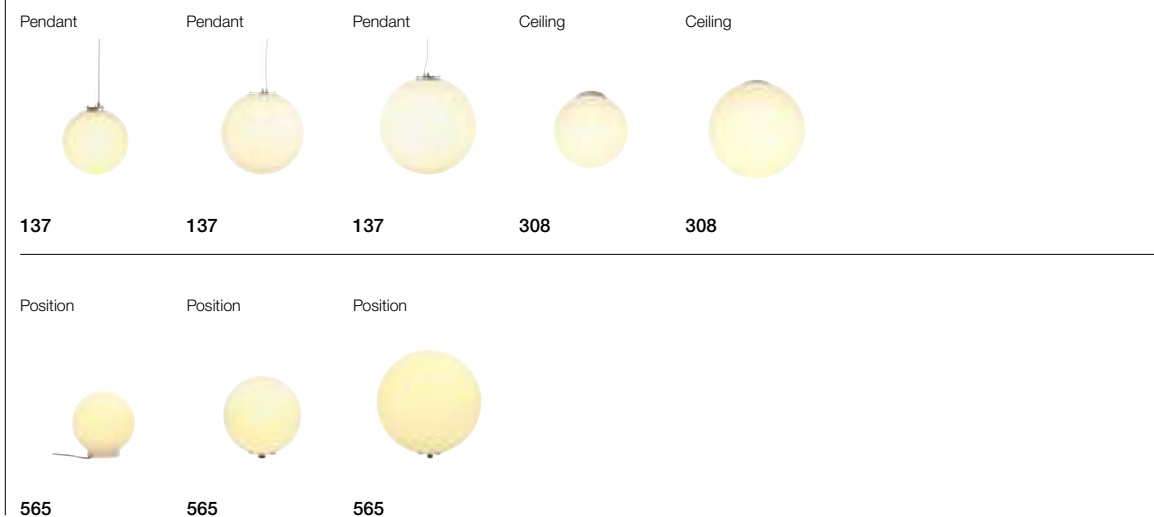











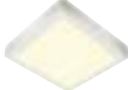

**ROX**























SENSOR

Wall/ceiling <b>NEW VARIANT</b>  366	Wall/ceiling <b>NEW VARIANT</b>  366	Wall/ceiling <b>NEW VARIANT</b>  366	Wall/ceiling <b>NEW VARIANT</b>  367	Wall/ceiling <b>NEW VARIANT</b>  367	Wall/ceiling <b>NEW VARIANT</b>  367
Installation <b>NEW</b>  449	Installation <b>NEW</b>  449	Installation <b>NEW</b>  449	Installation <b>NEW</b>  448	Installation <b>NEW</b>  448	Installation <b>NEW</b>  448

SIGHT LED

Wall/ceiling  370	Wall/ceiling  370	3-circuit track <b>NEW</b>  471, 811	3-circuit track  472	3-circuit track  483	3-circuit track <b>NEW</b>  496	3-circuit track  497
--	--	--	---	--	---	---

SITRA



Paths/position  612	Spike  623	Spike  623	Wall  656	Wall  656	Wall  680	Wall  680
Wall  691	Wall  691	Ceiling  704	Wall/ceiling  722			

SLOTS

Paths/position  591	Paths/position  591	Wall  644	<b>SOPRANA</b>
--	--	--	----------------

Pendant  138	Ceiling  285
---	---

SPOT E27

Wall  273	3-circuit track  478	1-circuit track  512
--	---	---





**SQUARE**

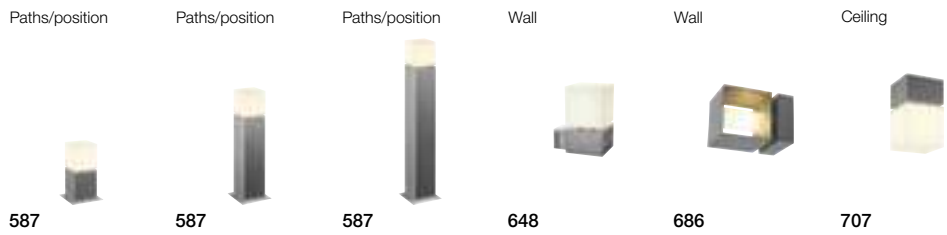

**STRUCTEC**

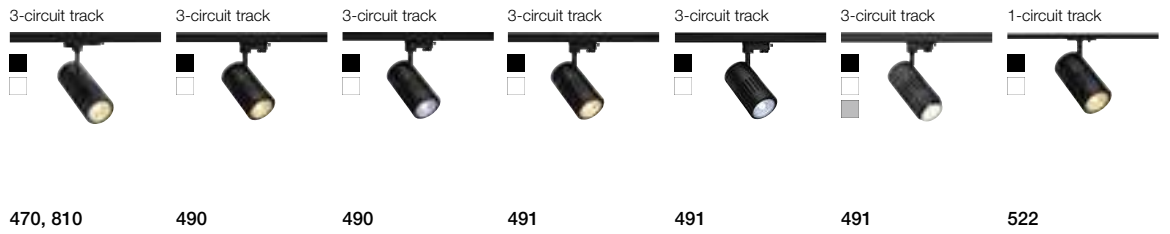

**SUPROS**

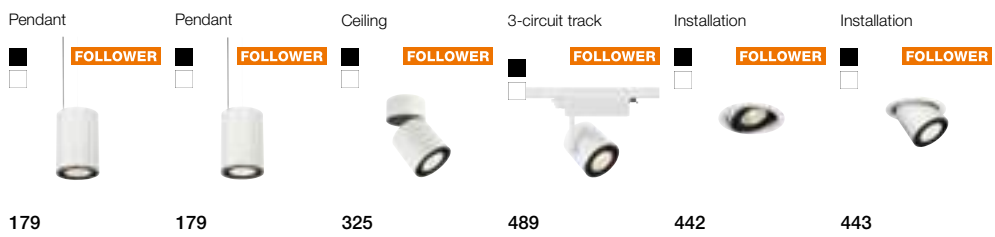

**SUPROS 78**

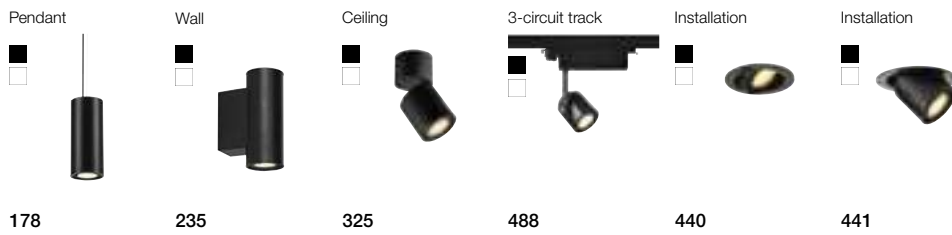

**TEC KALU**

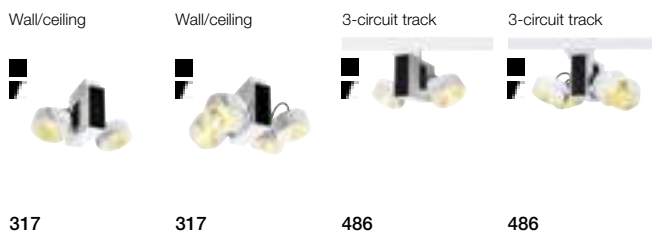

**THEO**



**THEO BRACKET**





**TONGA**

Pendant



132

1-circuit track



524

Easytec® II



538

**TRAPECCO**

Paths/position



606

Wall



670

**VINCELLI D**

Table



072

Pendant



111

Wall



271

Wall



271

**WORKLIGHT**

Position

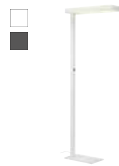

088

Position

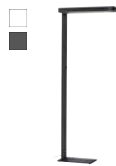

089

Pendant

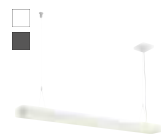

176

Pendant

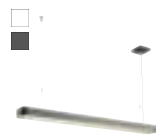

177



1000446 683

1000760 584

Note: The 7-digit product no. can be found on page 881 onwards

<b>111000</b>	113441..... 421	114260..... 433	115556..... 435
111260..... 386	113446..... 421	114261..... 433	115700..... 436
111262..... 386	113450..... 421	114270..... 433	115701..... 436
111290..... 385	113451..... 421	114271..... 433	115706..... 436
111292..... 385	113456..... 421	114280..... 433	115710..... 436
111360..... 423	113490..... 423	114281..... 433	115711..... 436
111361..... 423	113491..... 423	114290..... 433	115716..... 436
111362..... 424	113492..... 424	114291..... 433	115720..... 436
111380..... 425	113510..... 423	114380..... 428	115721..... 436
111381..... 425	113511..... 423	114381..... 428	115726..... 436
111382..... 425	113512..... 424	114386..... 428	115730..... 437
111482..... 671	113540..... 425	114390..... 428	115731..... 437
111710..... 422	113541..... 425	114391..... 428	115736..... 437
111711..... 422	113550..... 425	114396..... 428	115740..... 437
111716..... 422	113830..... 425	114400..... 426	115741..... 437
111720..... 422	113840..... 425	114401..... 426	115746..... 437
111721..... 422	113841..... 425	114406..... 426	
111726..... 422	113870..... 430	114420..... 409, 742	<b>116000</b>
111850..... 842	113871..... 430	114421..... 409, 742	116302..... 178, 235, 325,
111861..... 842	113876..... 430	114426..... 409, 742	..... 440, 441, 488
	113880..... 430	114430..... 409, 742	116304..... 178, 178, 235,
<b>112000</b>	113881..... 430	114431..... 409, 742	..... 325, 440, 441, 488
112161..... 393	113886..... 430	114436..... 409, 742	116310..... 440
112162..... 393	113890..... 431	114440..... 407, 740	116311..... 440
112165..... 393	113891..... 431	114441..... 407, 740	116320..... 441
112221..... 393	113896..... 431	114450..... 407, 740	116321..... 441
112222..... 393	113900..... 430	114451..... 407, 740	116330..... 325
112225..... 393	113901..... 430	114460..... 739	116331..... 325
112240..... 393	113906..... 430	114461..... 739	116340..... 235
112242..... 393	113910..... 430	114480..... 400	116341..... 235
112682..... 451	113911..... 430	114481..... 400	<b>117000</b>
112692..... 451	113916..... 430	114490..... 400	117100..... 323
112702..... 451	113920..... 431	114491..... 400	117101..... 323
112731..... 386	113921..... 431	114500..... 401	117110..... 323
112732..... 386	113926..... 431	114501..... 401	117111..... 323
112771..... 385	113930..... 321		117160..... 324
112772..... 385	113931..... 321	<b>115000</b>	117161..... 324
112780..... 385, 386, 389	113940..... 321	115011..... 439	117180..... 324
112781..... 385, 386, 389	113941..... 321	115014..... 439	117181..... 324
112910..... 415	113951..... 427	115151..... 439	117311..... 411
112911..... 415	113956..... 427	115152..... 439	117321..... 311
	113961..... 427	115351..... 438	117331..... 411
<b>113000</b>	113966..... 427	115352..... 438	117351..... 311
113110..... 415	113970..... 426	115414..... 438	
113111..... 415	113971..... 426	115510..... 434	<b>132000</b>
113140..... 413	113976..... 426	115511..... 434	132020..... 330
113141..... 413		115516..... 434	132021..... 330
113150..... 413	<b>114000</b>	115520..... 434	132024..... 330
113151..... 413	114102..... 179, 325, 442, 443, 489	115521..... 434	132600..... 098
113160..... 413	114104..... 179, 325, 442, 443, 489	115526..... 434	132601..... 098
113161..... 413	114220..... 432	115530..... 434	132605..... 098
113170..... 414	114221..... 432	115531..... 434	132610..... 098
113171..... 414	114230..... 432	115536..... 434	132611..... 098
113260..... 386	114231..... 432	115540..... 435	132615..... 098
113262..... 386	114240..... 433	115541..... 435	132620..... 098
113290..... 385	114241..... 433	115546..... 435	132621..... 098
113292..... 385	114250..... 433	115550..... 435	132625..... 098
113440..... 421	114251..... 433	115551..... 435	132650..... 094

132651.....	094	138981.....	555, 829	143070.....	529	143541.....	519
132660.....	102	138982.....	555, 829	143071.....	529	143544.....	519
132661.....	102	138990.....	555, 829	143072.....	529	143580.....	521
132662.....	102	138991.....	555, 829	143080.....	529	143581.....	521
132670.....	840	138992.....	555, 829	143081.....	529	143594.....	524
132671.....	840			143082.....	529	143620.....	523
132680.....	840	<b>139000</b>		143090.....	529	143621.....	523
132681.....	840	139004.....	554	143091.....	529	143731.....	519
132690.....	095	139006.....	555	143092.....	529	143811.....	516
132691.....	095	139024.....	554	143100.....	529	143930.....	525
132832.....	569	139026.....	554	143101.....	529	143931.....	525
132835.....	569	139030.....	554	143102.....	529	143932.....	525
		139031.....	554	143110.....	529	143941.....	521
<b>133000</b>		139040.....	554	143111.....	529	143951.....	521
133001.....	120	139041.....	554	143112.....	529	143960.....	523
133005.....	120	139050.....	554	143120.....	098, 526, 529	143961.....	523
133009.....	120	139051.....	554	143121.....	098, 526, 529	143964.....	523
133011.....	120	139060.....	555	143124.....	098, 526, 529	143990.....	524
133015.....	120	139061.....	555	143130.....	529	143991.....	524
133019.....	120	139070.....	544	143131.....	529		
133050.....	120	139071.....	544	143132.....	529	<b>144000</b>	
133060.....	120	139072.....	544	143151.....	529	144010.....	512
133120.....	178	139080.....	544	143152.....	526	144011.....	512
133121.....	178	139081.....	544	143160.....	529	144013.....	512
133300.....	115	139082.....	544	143161.....	529	144019.....	512
133310.....	115	139090.....	545	143162.....	529	144200.....	511
133320.....	115	139091.....	545	143169.....	529	144201.....	511
133330.....	114	139092.....	545	143170.....	526	144204.....	511
133341.....	122	139100.....	545	143171.....	526		
133351.....	122	139101.....	545	143172.....	526	<b>145000</b>	
133444.....	132	139102.....	545	143190.....	510	145100.....	501
133481.....	108	139110.....	547	143191.....	510	145102.....	501
133482.....	108	139111.....	547	143194.....	510	145200.....	501
133489.....	108	139112.....	547	143221.....	526	145202.....	501
133490.....	108	139120.....	551	143230.....	526	145300.....	501
133491.....	108	139121.....	551	143231.....	526	145302.....	501
133840.....	154	139122.....	551	143241.....	526	145510.....	502
133841.....	154	139130.....	546	143251.....	526	145514.....	502
133850.....	154	139131.....	546	143261.....	526	145520.....	502
133851.....	154	139132.....	546	143271.....	526	145524.....	502
				143281.....	526	145530.....	502
<b>135000</b>		<b>143000</b>		143350.....	517	145534.....	502
135020.....	144, 294	143010.....	528	143351.....	517	145551.....	505
135021.....	144, 294	143011.....	528	143354.....	517	145560.....	502
135024.....	144, 294	143012.....	528	143380.....	529	145564.....	502
135070.....	145, 295	143020.....	528	143381.....	529	145580.....	503
135071.....	145, 295	143021.....	528	143382.....	529	145584.....	503
135074.....	145, 295	143022.....	528	143390.....	512	145590.....	503
135120.....	146, 296	143030.....	529	143391.....	512	145594.....	503
135121.....	146, 296	143031.....	529	143392.....	512	145600.....	503
135124.....	146, 296	143032.....	529	143430.....	515	145604.....	503
135170.....	147, 297	143040.....	529	143431.....	515	145630.....	502
135171.....	147, 297	143041.....	529	143432.....	515	145634.....	502
135174.....	147, 297	143042.....	529	143440.....	515	145640.....	502
135250.....	121, 144-153, 294-303	143050.....	529	143441.....	515	145644.....	502
135251.....	121, 144-153, 294-303	143051.....	529	143442.....	515	145660.....	502
135254.....	121, 144-153, 294-303	143052.....	529	143450.....	511	145664.....	502
		143060.....	529	143451.....	511	145670.....	502
<b>138000</b>		143061.....	529	143454.....	511	145674.....	502
138980.....	555, 829	143062.....	529	143540.....	519	145680.....	503

145684.....	503	147551.....	330	151553.....	262	152371.....	127
145690.....	503	147559.....	330	151591.....	199	152380.....	391
145694.....	503	147566.....	218	151610.....	229	152381.....	391
145700.....	503			151611.....	229	152420.....	483
145710.....	503	<b>148000</b>		151710.....	228	152421.....	483
145714.....	503	148001.....	288	151711.....	228	152430.....	483
145720.....	503	148002.....	288	151740.....	228	152431.....	483
145724.....	503	148004.....	322	151741.....	228	152600.....	493
145730.....	503	148005.....	288	151781.....	220	152601.....	493
145734.....	503	148010.....	215	151786.....	220	152610.....	492
145830.....	503	148012.....	236	151791.....	220	152611.....	492
145834.....	503	148013.....	236	151796.....	220	152614.....	492
145990.....	098, 503	148015.....	215	151800.....	232	152640.....	478
145994.....	098, 503	148016.....	230	151801.....	232	152641.....	478
		148018.....	210	151803.....	232	152660.....	488
<b>146000</b>		148019.....	190	151804.....	232	152661.....	488
146000.....	084	148042.....	124	151810.....	313	152750.....	487
146010.....	084	148060.....	231	151811.....	313	152751.....	487
146111.....	075	148062.....	227	151813.....	313	152754.....	487
146242.....	390	148070.....	394	151814.....	313	152760.....	487
146252.....	390	148071.....	395	151830.....	338	152761.....	487
146260.....	390	148091.....	190	151831.....	338	152764.....	487
146332.....	273	148540.....	251	151840.....	232, 252, 313, 337, 338	152780.....	487
146452.....	272			151850.....	124	152781.....	487
146472.....	276	<b>149000</b>		151851.....	124	152784.....	487
146512.....	259	149381.....	125	151853.....	124	152790.....	487
146680.....	258	149385.....	125	151854.....	124	152791.....	487
146682.....	258	149387.....	125	151950.....	383	152794.....	487
146692.....	257	149388.....	125	151951.....	383	152960.....	482
146700.....	256	149452.....	248	151952.....	383	152961.....	482
146701.....	256	149471.....	219	151960.....	383		
146704.....	256	149472.....	219	151961.....	383	<b>153000</b>	
146800.....	267	149511.....	219	151962.....	383	153112.....	499
146801.....	267	149512.....	219			153130.....	499
146804.....	267	149762.....	261	<b>152000</b>		153131.....	499
146942.....	308	149772.....	261	152010.....	337	153140.....	499
				152011.....	337	153141.....	499
<b>147000</b>		<b>151000</b>		152013.....	337	153420.....	494
147301.....	350	151040.....	108, 257, 512	152020.....	337	153421.....	494
147306.....	350	151041.....	108, 257, 273, 512	152021.....	337	153424.....	494
147311.....	350	151049.....	108, 257, 273, 512	152023.....	337	153560.....	484
147316.....	350	151271.....	223	152101.....	315	153561.....	484
147321.....	350	151275.....	223	152200.....	478	153564.....	484
147326.....	350	151282.....	264	152201.....	478	153580.....	492
147360.....	349	151311.....	222	152230.....	485	153581.....	492
147361.....	349	151315.....	222	152231.....	485	153584.....	492
147370.....	349	151320.....	212	152232.....	485	153600.....	493
147371.....	349	151321.....	212	152240.....	485	153850.....	494
147380.....	349	151325.....	212	152241.....	485	153851.....	494
147381.....	349	151410.....	224	152242.....	485	153854.....	494
147411.....	341	151411.....	224	152320.....	479		
147412.....	341	151416.....	224	152321.....	479	<b>155000</b>	
147414.....	341	151450.....	224	152330.....	334	155152.....	360
147441.....	347	151451.....	224	152331.....	334	155156.....	360
147442.....	347	151456.....	224	152340.....	253	155180.....	361
147443.....	347	151511.....	316	152341.....	253	155236.....	360
147444.....	347	151514.....	316	152360.....	127	155372.....	285
147529.....	199	151531.....	316, 332	152361.....	127	155373.....	285
147550.....	330	151534.....	316, 332	152370.....	127	155462.....	138

155463.....	138	158410.....	126	184004.....	539	188520.....	557
155490.....	079	158411.....	126	184010.....	539	188530.....	556
155492.....	079	158723.....	163	184012.....	539	188550.....	556
155520.....	118	158724.....	163	184020.....	539		
155530.....	118	158733.....	163	184022.....	539	<b>210000</b>	
155531.....	118	158734.....	163	184030.....	539	210060.....	841
155540.....	079			184032.....	539	210061.....	841
155550.....	282	<b>159000</b>		184060.....	539	210064.....	841
155551.....	282	159140.....	173	184062.....	539	214350.....	786
155552.....	282	159141.....	173	184071.....	536	214351.....	786
155570.....	105, 283	159144.....	173	184140.....	539		
155582.....	080, 105, 283	159210.....	174	184142.....	539	<b>220000</b>	
155583.....	080, 105, 283	159211.....	174	184170.....	539	220000.....	842
155592.....	080, 105, 283	159220.....	174	184172.....	539		
155670.....	246	159221.....	174	184290.....	539	<b>227000</b>	
155673.....	246	159230.....	174	184292.....	539	227090.....	753
155714.....	131	159231.....	174	184300.....	539	227092.....	753
155752.....	197			184302.....	539	227140.....	828
155780.....	078	<b>160000</b>		184302.....	539	227160.....	828
155785.....	078	160900.....	164	184330.....	539	227160.....	828
155790.....	078	160901.....	164	184332.....	539	227174.....	651
155795.....	078	160904.....	164	184440.....	535	227176.....	651
155870.....	139			184450.....	535	227185.....	659
155871.....	139	<b>161000</b>		184452.....	535	227194.....	661
155910.....	119	161271.....	399	184530.....	538	227195.....	661
155911.....	119	161281.....	399	184534.....	538	227198.....	661
155930.....	119	161291.....	399	184590.....	537	227219.....	565
155931.....	119	161301.....	399	184630.....	536	227220.....	565
155960.....	113	161461.....	289	184634.....	536	227221.....	565
155970.....	113	161464.....	289			227410.....	618
				<b>185000</b>		227418.....	618
				185580.....	537	227461.....	748
				185590.....	537	227462.....	748
<b>156000</b>		<b>165000</b>				227504.....	622
156050.....	285	165100.....	183			227505.....	622
156051.....	285	165221.....	183	<b>186000</b>		227507.....	622
156100.....	081, 105, 283	165222.....	183	186300.....	555	227508.....	622
156111.....	081, 105, 283	165350.....	182	186301.....	555	227600.....	751
156113.....	081, 105, 283	165356.....	182	186302.....	555	227604.....	751
156122.....	081, 105, 283	165358.....	182	186310.....	555	227680.....	750
156141.....	080, 104	165359.....	182	186311.....	555	227684.....	750
156143.....	080, 104	165390.....	137	186312.....	555	227700.....	700
156152.....	080, 104	165400.....	137	186330.....	555	227701.....	700
156268.....	111	165410.....	137	186331.....	555	227734.....	635
156420.....	336			186332.....	555	227744.....	635
156421.....	336	<b>175000</b>		186340.....	555	227922.....	579, 580
156500.....	339	175060.....	477	186341.....	555		
156501.....	339	175080.....	477	186342.....	555	<b>228000</b>	
156510.....	339	175160.....	477	186350.....	555	228100.....	579
156511.....	339	175180.....	477	186351.....	555	228110.....	579
156530.....	391	175190.....	477	186352.....	555	228130.....	579
156531.....	391	175210.....	477	186360.....	555	228210.....	753
				186361.....	555	228214.....	753
<b>157000</b>		<b>181000</b>		186362.....	555	228240.....	753
157671.....	172	181530.....	555	186640.....	555	228332.....	749
157901.....	088	181531.....	555	186641.....	555	228342.....	749
157905.....	088	181532.....	555	186642.....	555	228370.....	760
						228411.....	754
<b>158000</b>		<b>184000</b>		<b>188000</b>		228412.....	754
158400.....	126	184000.....	539	188500.....	557	228430.....	759
158401.....	126	184002.....	539	188510.....	557		

228434.....	759	229482.....	636	231012.....	240, 659	232095.....	568
228545.....	607	229521.....	676	231015.....	240, 659	232101.....	692
228555.....	631	229524.....	676	231035.....	621	232104.....	692
228560.....	631	229525.....	676	231045.....	720	232105.....	692
228712.....	575, 576, 613	229531.....	693	231055.....	720	232115.....	586
228722.....	575, 576	229532.....	693	231072.....	634	232119.....	586
228725.....	843	229535.....	693	231205.....	648	232125.....	586
228726.....	843	229551.....	709	231215.....	586	232135.....	598
228730.....	843	229554.....	709	231225.....	586	232145.....	598
228752.....	586, 613	229555.....	709	231230.....	586, 601	232155.....	596
228753.....	573, 591	229561.....	676	231231.....	605	232165.....	596
228754.....	586	229564.....	676	231233.....	590	232175.....	597
228771.....	680	229565.....	676	231234.....	574, 581, 587	232185.....	597
228775.....	680	229571.....	693	231235.....	600	232195.....	596, 597
228776.....	680	229574.....	693	231305.....	605	232285.....	671
228922.....	576	229575.....	693	231315.....	668	232294.....	605
228925.....	576	229664.....	699	231351.....	667	232295.....	605
228935.....	576	229665.....	699	231355.....	667	232431.....	239, 672
228945.....	576	229702.....	730	231370.....	600	232435.....	239, 672
228960.....	567	229740.....	620	231371.....	600	232441.....	214, 687
228965.....	567	229741.....	629	231410.....	589	232445.....	214, 687
<b>229000</b>		229931.....	717	231411.....	589	232451.....	687
229020.....	571	229935.....	717	231420.....	590	232455.....	687
229021.....	571	229941.....	717	231440.....	600	232461.....	239, 672
229022.....	571	229945.....	717	231455.....	591	232465.....	239, 672
229050.....	582	229951.....	717	231457.....	591	232471.....	214, 687
229054.....	582	229955.....	717	231465.....	646	232475.....	214, 687
229057.....	582	229961.....	712	231475.....	583	232481.....	690
229059.....	582	229965.....	712	231505.....	612	232485.....	690
229062.....	730	229971.....	712	231515.....	722	232491.....	689
229071.....	715	229975.....	712	231525.....	623	232495.....	689
229072.....	715	<b>230000</b>		231535.....	623	232497.....	689
229075.....	715	230030.....	669	231541.....	704	232531.....	691
229081.....	715	230034.....	669	231545.....	704	232535.....	691
229085.....	715	230044.....	655	231585.....	646	232537.....	691
229090.....	627	230045.....	655	231595.....	583	232840.....	633
229100.....	629	230060.....	578, 582, 607, 612	231602.....	579	232860.....	633
229110.....	733	230061.....	582	231612.....	579	232864.....	633
229162.....	580	230063.....	582	231672.....	625	232870.....	633
229172.....	580	230066.....	582	231682.....	625	232874.....	633
229182.....	647	230069.....	582	231745.....	670	232880.....	633
229200.....	760	230084.....	655	231765.....	606	232884.....	633
229230.....	760	230085.....	655	231805.....	644	232890.....	633
229234.....	760	230090.....	603	231807.....	644	232894.....	633
229320.....	759	230100.....	764	231815.....	591	232905.....	666
229324.....	759	230110.....	764	231817.....	591	232915.....	666
229374.....	759	230170.....	751	231835.....	602	<b>233000</b>	
229381.....	763	230174.....	751	231845.....	602	233094.....	722
229383.....	763	230355.....	656	231849.....	602	233095.....	722
229410.....	601	230365.....	680	231855.....	592	233104.....	722
229411.....	601	230435.....	569	231865.....	662	233105.....	722
229420.....	588	230444.....	651	231960.....	637	233114.....	679
229421.....	588	230445.....	651	231961.....	637	233115.....	679
229422.....	572, 588, 589, 603	230465.....	573	<b>232000</b>		233134.....	701
229423.....	570	230655.....	654	232045.....	642	233135.....	701
229430.....	570	230657.....	654	232055.....	702	233144.....	613
229431.....	570			232065.....	562	233145.....	613
229432.....	570	<b>231000</b>		232075.....	573	233164.....	613
229481.....	636	231010.....	240, 659	232085.....	573	233165.....	613



233184.....	613	240021.....	373	560233.....	851	1000328.....	216
233185.....	613	240022.....	375	560234.....	851	1000329.....	216
233214.....	679, 701, 722	240024.....	405	560302.....	846	1000330.....	216
233215.....	679, 701, 722			560332.....	846	1000331.....	693
233241.....	723	<b>451000</b>		560372.....	852	1000332.....	314, 706
233245.....	723	451105.....	828	560402.....	852	1000333.....	234, 657
233251.....	723	451301.....	828	560422.....	853	1000334.....	234, 683
233255.....	723			560473.....	857	1000335.....	686
233275.....	613	<b>461000</b>		560702.....	851	1000336.....	648
233285.....	613	461060.....	830	560704.....	851	1000339.....	706
233302.....	681	461157.....	830	560722.....	851	1000340.....	236, 678
233312.....	681			560724.....	851	1000342.....	236, 678
233407.....	571	<b>464000</b>		560741.....	855	1000343.....	587
233417.....	571	464030.....	839			1000344.....	587
233427.....	588	464031.....	838	<b>631000</b>		1000345.....	587
233437.....	588	464032.....	837	631300.....	805	1000346.....	587
233447.....	601	464091.....	838	631301.....	805	1000384.....	752
233457.....	601	464108.....	838	631302.....	805	1000387.....	453
233500.....	757	464109.....	838	631303.....	805	1000390.....	453
233520.....	757	464140.....	833	631304.....	805	1000398.....	562, 563
233530.....	757	464142.....	834	631305.....	805		
233540.....	755	464144.....	834	631313.....	805	<b>1000400</b>	
233570.....	630	464168.....	839	631315.....	805	1000416.....	587
233571.....	630	464170.....	839	631317.....	805	1000417.....	587
233580.....	630	464200.....	839	631323.....	805	1000418.....	587
233582.....	630	464804.....	835	631325.....	805	1000422.....	241
233601.....	731			631327.....	805	1000423.....	241
233605.....	731	<b>470000</b>		631337.....	369	1000426.....	335
233611.....	731	470500.....	832	631339.....	369	1000427.....	335
233615.....	731	470502.....	831	631347.....	369	1000433.....	117
233621.....	731	470505.....	831	631349.....	369	1000434.....	116
233625.....	731	470506.....	831			1000435.....	116
233635.....	732	470540.....	832	<b>900000</b>		1000436.....	116
233639.....	732	470541.....	831	900011.....	629, 630	1000437.....	286
233650.....	733	470542.....	831			1000438.....	117
233660.....	733	470544.....	831	<b>955000</b>		1000439.....	116
233792.....	752	470545.....	831	955135.....	842	1000440.....	116
234340.....	633	470546.....	831			1000441.....	116
234350.....	633	470547.....	832	<b>961000</b>		1000442.....	286
234401.....	087, 578	470548.....	832	961034.....	841	1000443.....	286
234411.....	087, 578	470549.....	832	961037.....	841	1000445.....	286
234421.....	087, 578			961250.....	841	1000446.....	683
234430.....	087, 578	<b>548000</b>		961270.....	841	1000447.....	706
234431.....	087, 578	548014.....	857	961271.....	841	1000448.....	657
234441.....	087, 578	548021.....	857	961276.....	841	1000449.....	579
234505.....	694					1000457.....	769
234515.....	695	<b>550000</b>		<b>1000100</b>		1000458.....	769
234525.....	677	550073.....	857	1000127.....	352	1000459.....	769
234535.....	709	550074.....	857	1000128.....	352	1000460.....	769
		550092.....	857	1000129.....	352	1000461.....	769
<b>240000</b>				1000130.....	352	1000462.....	769
240000.....	372	<b>551000</b>		1000131.....	352	1000463.....	769
240002.....	373	551372.....	857	1000132.....	352	1000464.....	769
240004.....	375	551402.....	851	1000135.....	353	1000465.....	769
240006.....	405	551882.....	850	1000136.....	353	1000466.....	770, 773
240007.....	372	560122.....	848			1000467.....	770, 773
240008.....	373			<b>1000300</b>		1000468.....	770, 773
240009.....	375	<b>560000</b>		1000324.....	251	1000469.....	770, 773
240010.....	375	560231.....	851	1000326.....	251	1000470.....	770
240020.....	372	560232.....	851	1000327.....	216	1000471.....	770

1000472.....	771	1000575.....	385	1000710.....	499	1000823.....	702
1000473.....	771	1000576.....	386	1000711.....	521	1000824.....	205
1000474.....	771	1000577.....	386	1000712.....	521	1000825.....	207
1000475.....	771	1000579.....	081, 105, 283	1000713.....	523	1000827.....	184
1000476.....	771	1000580.....	081, 105, 283	1000714.....	396	1000828.....	184
1000477.....	771	1000587.....	698	1000715.....	396	1000833.....	737
1000478.....	771	1000588.....	698	1000716.....	396	1000834.....	648
1000479.....	771			1000717.....	396	1000835.....	707
1000480.....	771	<b>1000600</b>		1000718.....	397	1000855.....	146, 296
1000481.....	771	1000613.....	204	1000719.....	397	1000856.....	146, 296
1000482.....	771	1000614.....	206	1000720.....	397	1000857.....	146, 296
1000483.....	771	1000615.....	206	1000721.....	397	1000864.....	146, 296
1000484.....	771	1000616.....	205	1000725.....	152, 302	1000865.....	146, 296
1000485.....	771	1000618.....	205	1000726.....	152, 302	1000866.....	146, 296
1000486.....	771	1000619.....	205	1000727.....	152, 302	1000880.....	700
1000487.....	770	1000621.....	207	1000729.....	252	1000881.....	700
1000488.....	770	1000623.....	207	1000730.....	252	1000886.....	345
1000489.....	770	1000624.....	207	1000731.....	252	1000887.....	345
1000496.....	776	1000631.....	315	1000732.....	252	1000888.....	345
1000497.....	776	1000634.....	223	1000733.....	275	1000889.....	345
1000498.....	776	1000635.....	223	1000734.....	275	1000890.....	345
		1000636.....	223	1000735.....	631	1000891.....	345
<b>1000500</b>		1000637.....	223	1000736.....	610, 611, 631	1000892.....	345
1000505.....	775	1000638.....	212	1000743.....	191	1000893.....	345
1000506.....	775	1000639.....	212	1000745.....	191	1000894.....	345
1000507.....	775	1000640.....	212	1000746.....	191	1000895.....	345
1000514.....	775	1000655.....	752	1000748.....	191	1000896.....	345
1000515.....	775	1000656.....	491	1000760.....	584	1000897.....	345
1000516.....	775	1000657.....	491	1000761.....	584		
1000523.....	775	1000658.....	491	1000762.....	584	<b>1000900</b>	
1000524.....	775	1000665.....	572	1000763.....	079	1000909.....	842
1000525.....	775	1000666.....	572	1000764.....	081, 102	1000910.....	210
1000532.....	775	1000668.....	269	1000769.....	493	1000911.....	210
1000533.....	775	1000669.....	269	1000773.....	102	1000914.....	416
1000534.....	775	1000670.....	269	1000777.....	265	1000915.....	416
1000535.....	779	1000677.....	488	1000778.....	265	1000917.....	416
1000536.....	779	1000678.....	488	1000780.....	265	1000918.....	184, 185
1000537.....	779	1000681.....	645	1000781.....	265	1000926.....	170
1000540.....	777	1000682.....	577	1000783.....	304	1000927.....	170
1000546.....	777	1000683.....	577	1000784.....	304	1000928.....	170
1000549.....	777	1000685.....	306	1000785.....	304	1000929.....	170
1000552.....	777	1000686.....	306	1000786.....	304	1000930.....	170
1000555.....	777	1000687.....	306	1000792.....	452	1000931.....	170
1000556.....	778	1000688.....	306	1000794.....	452	1000932.....	170
1000557.....	778	1000689.....	306	1000797.....	660	1000933.....	170
1000558.....	778	1000690.....	306	1000799.....	593	1000934.....	170
1000559.....	778	1000691.....	307			1000935.....	170
1000560.....	778	1000692.....	307	<b>1000800</b>		1000936.....	170
1000561.....	778	1000693.....	307	1000801.....	593	1000937.....	170
1000562.....	778	1000694.....	307	1000807.....	313	1000939.....	234, 657, 851
1000563.....	778	1000695.....	307	1000808.....	313	1000940.....	851
1000564.....	778	1000696.....	307	1000809.....	130, 313	1000957.....	105, 283
1000565.....	778			1000810.....	130, 313	1000974.....	522
1000566.....	778	<b>1000700</b>		1000811.....	130, 313	1000975.....	522
1000567.....	778	1000702.....	350	1000812.....	130, 313	1000977.....	522
1000568.....	778	1000703.....	350	1000813.....	130	1000978.....	522
1000569.....	778	1000704.....	350	1000814.....	130	1000980.....	490
1000570.....	778	1000707.....	480	1000820.....	642	1000981.....	490
1000571.....	777	1000708.....	480	1000821.....	563	1000983.....	490
1000574.....	385	1000709.....	499	1000822.....	578	1000984.....	490

1000986.....	490	1001266.....	116	1001406.....	168	1001491.....	581
1000987.....	490	1001267.....	834	1001407.....	168	1001492.....	581
1000989.....	490	1001272.....	202	1001409.....	168	1001493.....	581
1000990.....	490	1001273.....	202	1001410.....	168	1001494.....	581
1000992.....	491	1001274.....	202	1001419.....	486	1001495.....	334
1000993.....	491	1001275.....	202	1001420.....	486	1001496.....	334
1000995.....	491	1001276.....	202	1001421.....	486	<b>1001500</b>	
1000996.....	491	1001283.....	370	1001422.....	486	1001505.....	305
1000998.....	491	1001284.....	370	1001423.....	317	1001506.....	305
1000999.....	491	1001285.....	370	1001424.....	317	1001508.....	305
<b>1001000</b>		1001286.....	370	1001425.....	317	1001509.....	305
1001001.....	491	1001287.....	370	1001426.....	317	1001510.....	501
1001002.....	491	1001288.....	370	1001427.....	486	1001511.....	501
1001009.....	275	1001289.....	483	1001428.....	486	1001512.....	501
1001010.....	275	1001290.....	483	1001429.....	486	1001513.....	502
1001015.....	404, 743	1001292.....	483	1001430.....	486	1001514.....	502
1001016.....	404, 743	1001295.....	172	1001431.....	317	1001515.....	502
1001017.....	404, 743	1001296.....	172	1001432.....	317	1001516.....	502
1001018.....	404, 743	1001297.....	172	1001433.....	317	1001517.....	502
1001019.....	371	1001299.....	268	1001434.....	317	1001518.....	502
1001020.....	371	<b>1001300</b>		1001435.....	317	1001519.....	502
1001030.....	849	1001300.....	268	1001436.....	317	1001520.....	502
1001031.....	853	1001301.....	268	1001447.....	163	1001521.....	503
1001033.....	853	1001303.....	268	1001448.....	163	1001522.....	503
1001035.....	856	1001304.....	268	1001449.....	244	1001523.....	503
1001038.....	856	1001305.....	268	1001450.....	244	1001524.....	503
<b>1001100</b>		1001306.....	169	1001451.....	245	1001525.....	503
1001114.....	834	1001307.....	169	1001452.....	245	1001526.....	503
1001115.....	834	1001308.....	169	1001453.....	245	1001527.....	503
1001132.....	453	1001309.....	169	1001454.....	245	1001528.....	503
1001133.....	453	1001310.....	169	1001460.....	082	1001529.....	503
1001136.....	453	1001312.....	169	1001461.....	082	1001530.....	503
1001155.....	392	1001314.....	365	1001462.....	083	1001531.....	505
1001156.....	392	1001315.....	365	1001463.....	083	1001532.....	505
1001165.....	402, 738	1001316.....	365	1001464.....	275	1001533.....	505
1001166.....	402, 738	1001317.....	365	1001465.....	275	1001534.....	505
1001167.....	402, 738	1001344.....	160	1001466.....	481	1001536.....	505
1001168.....	402, 738	1001345.....	160	1001467.....	481	1001537.....	505
1001169.....	402, 738	1001347.....	160	1001468.....	243	1001538.....	505
1001170.....	402, 738	1001347.....	160	1001469.....	243	1001539.....	505
1001171.....	402, 738	1001348.....	160	1001470.....	481	1001542.....	098, 503
1001172.....	402, 738	1001350.....	116	1001471.....	481	1001568.....	851
<b>1001200</b>		1001351.....	116	1001472.....	243	1001570.....	851
1001242.....	850	1001357.....	856	1001473.....	243	1001572.....	851
1001244.....	850	1001359.....	746	1001474.....	481	1001574.....	846
1001249.....	839	1001367.....	495	1001475.....	481	1001575.....	846
1001250.....	458	1001368.....	495	1001476.....	495	<b>1001600</b>	
1001251.....	459	1001369.....	495	1001477.....	495	1001647.....	163
1001252.....	747	1001380.....	477	1001478.....	495	1001648.....	163
1001253.....	747	1001382.....	477	1001479.....	495	1001676.....	070
1001254.....	747	1001390.....	477	1001480.....	495	1001677.....	070
1001255.....	747	1001392.....	477	1001481.....	495	1001678.....	070
1001256.....	746	1001393.....	477	1001482.....	495	1001691.....	184, 185
1001262.....	747	1001395.....	477	1001483.....	495	1001692.....	184, 185
1001263.....	747	<b>1001400</b>		1001484.....	495	<b>1001700</b>	
1001264.....	406	1001400.....	168	1001485.....	516	1001701.....	118
1001265.....	117	1001401.....	168	1001486.....	516	1001756.....	855
		1001403.....	168	1001488.....	581	1001778.....	564
		1001404.....	168	1001489.....	581		
				1001490.....	581		

1001796.....	787	1001891.....	151, 301	1001990.....	429	1002068.....	072
1001797.....	787	1001892.....	151, 301	1001991.....	429	1002069.....	669
1001798.....	787	1001893.....	150, 300	1001992.....	429	1002070.....	669
1001799.....	787	1001894.....	150, 300	1001993.....	429	1002071.....	669
		1001895.....	150, 300	1001994.....	420	1002075.....	358
<b>1001800</b>		1001896.....	150, 300	1001995.....	420	1002076.....	358
1001800.....	787	1001897.....	150, 300	1001996.....	420	1002077.....	358
1001801.....	787	1001898.....	150, 300	1001997.....	580	1002082.....	835
1001802.....	787	1001899.....	150, 300	1001998.....	580	1002098.....	408, 741
1001803.....	787			1001999.....	574	1002099.....	408, 741
1001804.....	787	<b>1001900</b>					
1001805.....	787	1001900.....	150, 300	<b>1002000</b>		<b>1002100</b>	
1001806.....	786	1001901.....	454	1002000.....	574	1002100.....	408, 741
1001807.....	786	1001902.....	455	1002001.....	574	1002101.....	408, 741
1001808.....	786	1001903.....	455	1002002.....	642	1002102.....	408, 741
1001809.....	786	1001904.....	455	1002003.....	321	1002103.....	408, 741
1001813.....	786	1001905.....	456	1002004.....	319	1002110.....	514
1001814.....	785	1001906.....	456	1002005.....	319	1002111.....	514
1001815.....	786	1001907.....	456	1002006.....	319	1002113.....	514
1001816.....	785	1001908.....	457	1002008.....	321	1002116.....	258
1001817.....	785	1001916.....	852	1002010.....	319	1002117.....	258
1001818.....	098	1001917.....	852	1002011.....	319	1002118.....	258
1001819.....	098	1001918.....	848	1002012.....	319	1002119.....	258
1001820.....	098	1001919.....	848	1002013.....	319	1002124.....	854
1001821.....	098	1001920.....	850	1002015.....	319	1002126.....	854
1001823.....	603	1001921.....	850	1002016.....	656	1002127.....	854
1001824.....	603	1001922.....	850	1002017.....	656	1002132.....	356
1001855.....	716	1001923.....	850	1002018.....	680	1002133.....	356
1001856.....	716	1001924.....	416	1002020.....	357	1002134.....	356
1001857.....	276	1001925.....	416	1002021.....	357	1002135.....	846
1001858.....	276	1001927.....	416	1002022.....	357	1002136.....	115
1001861.....	516	1001930.....	403, 737	1002023.....	350	1002137.....	115
1001862.....	520	1001931.....	403, 737	1002024.....	350	1002138.....	115
1001863.....	520	1001932.....	403, 737	1002025.....	350	1002139.....	114
1001864.....	520	1001933.....	403, 737	1002029.....	349	1002140.....	253
1001865.....	482	1001934.....	737	1002030.....	349	1002145.....	085
1001866.....	482	1001937.....	621	1002032.....	691	1002146.....	085
1001867.....	482	1001938.....	621	1002033.....	691	1002147.....	200
1001868.....	511	1001939.....	289	1002034.....	691	1002148.....	200
1001869.....	511	1001940.....	111	1002035.....	689	1002149.....	200
1001870.....	511	1001941.....	111	1002036.....	689	1002150.....	085
1001871.....	485	1001942.....	111	1002037.....	689	1002151.....	528
1001872.....	485	1001943.....	111	1002041.....	680	1002152.....	528
1001874.....	512	1001944.....	111	1002045.....	137	1002153.....	528
1001875.....	512	1001945.....	111	1002046.....	137	1002155.....	670
1001876.....	512	1001950....	121, 144-153, 294-303	1002047.....	106	1002157.....	711
1001877.....	148, 298	1001951....	121, 144-153, 294-303	1002048.....	497	1002158.....	606
1001878.....	149, 299	1001952....	121, 144-153, 294-303	1002049.....	497	1002159.....	096
1001879.....	149, 299	1001962.....	629	1002050.....	497	1002160.....	096
1001880.....	149, 299	1001963.....	629	1002051.....	308	1002161.....	096
1001881.....	148, 298	1001964.....	618	1002052.....	308	1002162.....	096
1001882.....	148, 298	1001965.....	618	1002053.....	181	1002163.....	098
1001883.....	149, 299	1001968.....	524	1002054.....	181	1002164.....	098
1001884.....	149, 299	1001969.....	667	1002055.....	181	1002165.....	098
1001885.....	149, 299	1001970.....	667	1002056.....	181	1002167.....	094
1001886.....	149, 299	1001978.....	429	1002057.....	181	1002168.....	095
1001887.....	149, 299	1001980.....	420	1002058.....	181	1002169.....	126
1001888.....	149, 299	1001981.....	420	1002059.....	181	1002170.....	126
1001889.....	150, 300	1001982.....	420	1002066.....	271	1002171.....	127
1001890.....	151, 301	1001989.....	429	1002067.....	271	1002172.....	127

1002173.....	253	1002558.....	097	1002662.....	472	1002871.....	608
1002185.....	751	1002562.....	097	1002681.....	495	1002873.....	513
1002186.....	751	1002563.....	097	1002682.....	495	1002874.....	513
1002187.....	757	1002564.....	097	1002683.....	495	1002875.....	513
1002188.....	754	1002582.....	071	1002686.....	499	1002876.....	480
1002189.....	749	1002583.....	071	1002688.....	551	1002877.....	480
1002190.....	262	1002584.....	333	1002689.....	551	1002878.....	480
1002191.....	262	1002585.....	333	1002690.....	551	1002879.....	446
1002192.....	262	1002591.....	416	1002691.....	829	1002880.....	446
1002198.....	610	1002592.....	416	1002692.....	829	1002881.....	447
1002199.....	610	1002594.....	416	1002693.....	829	1002882.....	153, 303
		1002596.....	416	1002694.....	550	1002884.....	719, 720
<b>1002200</b>		1002597.....	667	1002695.....	550	1002885.....	446
1002200.....	611	1002598.....	438	1002696.....	550	1002886.....	446
1002201.....	622	1002599.....	438	1002697.....	555	1002887.....	447
1002202.....	622			1002698.....	555	1002888.....	446
1002203.....	622	<b>1002600</b>		1002699.....	555	1002889.....	446
1002204.....	397	1002600.....	438			1002890.....	155
1002205.....	397	1002601.....	438	<b>1002700</b>		1002891.....	155
1002206.....	397	1002602.....	554	1002700.....	555	1002893.....	763
1002207.....	397	1002603.....	554	1002701.....	555	1002895.....	763
1002208.....	397	1002604.....	554	1002702.....	555	1002897.....	763
1002209.....	397	1002605.....	673	1002703.....	555	1002898.....	763
1002210.....	397	1002606.....	673	1002704.....	555	1002899.....	763
1002211.....	397	1002607.....	257	1002705.....	555		
1002215.....	316, 332	1002608.....	257	1002785.....	833	<b>1002900</b>	
1002216.....	316	1002610.....	510	1002791.....	833	1002900.....	688
1002217.....	102	1002611.....	510	1002792.....	834	1002902.....	688
1002218.....	830	1002612.....	510			1002903.....	721
1002220.....	830	1002631.....	475	<b>1002800</b>		1002904.....	721
1002221.....	830	1002632.....	475	1002803.....	833	1002905.....	700
1002228.....	263	1002633.....	475	1002827.....	853	1002906.....	607
1002229.....	263	1002634.....	475	1002828.....	853	1002907.....	607
1002232.....	454, 456	1002635.....	475	1002838.....	176	1002909.....	157
1002236.....	787	1002636.....	475	1002839.....	176	1002910.....	157
1002237.....	787	1002637.....	476	1002842.....	213	1002911.....	157
1002238.....	209	1002638.....	476	1002843.....	213	1002912.....	157
1002239.....	225	1002639.....	476	1002844.....	213	1002913.....	157
1002240.....	225	1002640.....	476	1002845.....	477, 503, 526, 529	1002914.....	157
1002264.....	098	1002641.....	476	1002847.....	089	1002915.....	194
1002265.....	098	1002642.....	476	1002848.....	089	1002917.....	194
		1002643.....	476	1002849.....	177	1002918.....	194
<b>1002400</b>		1002644.....	476	1002850.....	177	1002919.....	194
1002402.....	652	1002645.....	476	1002853.....	696, 697	1002920.....	242
1002403.....	653	1002646.....	476	1002854.....	519	1002921.....	242
1002404.....	086	1002647.....	476	1002855.....	246	1002922.....	388
1002405.....	086	1002648.....	477	1002856.....	246	1002925.....	198
1002420.....	454, 456	1002649.....	476	1002858.....	121	1002926.....	198
1002422.....	455, 456, 457	1002650.....	477	1002859.....	249	1002927.....	198
1002423.....	837	1002651.....	477	1002860.....	273	1002928.....	213
1002424.....	837	1002652.....	477	1002861.....	548	1002929.....	213
1002430.....	258	1002653.....	477	1002862.....	548	1002930.....	213
1002431.....	258	1002654.....	477	1002863.....	548	1002931.....	232
1002432.....	258	1002655.....	477	1002864.....	549	1002932.....	232
1002494.....	566	1002656.....	477	1002865.....	549	1002933.....	232
		1002657.....	477	1002866.....	549	1002934.....	312
<b>1002500</b>		1002658.....	477	1002867.....	720	1002935.....	312
1002503.....	674	1002659.....	477	1002868.....	658	1002936.....	312
1002504.....	675	1002660.....	477	1002869.....	658	1002937.....	123
1002505.....	675	1002661.....	472	1002870.....	608	1002938.....	123

1002939.....	123	1003007.....	135	1003070.....	428	1003298.....	489
1002940.....	359	1003008.....	448	1003073.....	461	1003299.....	442
1002941.....	359	1003009.....	448	1003074.....	460		
1002942.....	247	1003010.....	448	1003075.....	461	<b>1003300</b>	
1002943.....	247	1003011.....	449	1003076.....	463	1003300.....	442
1002944.....	284	1003012.....	449	1003077.....	463	1003301.....	442
1002945.....	284	1003013.....	449	1003078.....	463	1003302.....	442
1002946.....	139	1003014.....	367	1003079.....	463	1003303.....	442
1002947.....	139	1003015.....	367	1003080.....	463	1003304.....	442
1002948.....	115	1003016.....	367	1003081.....	463	1003305.....	442
1002949.....	115	1003017.....	366	1003083.....	461	1003306.....	442
1002950.....	115	1003018.....	366	1003084.....	461	1003307.....	443
1002951.....	114	1003019.....	366	1003085.....	855	1003308.....	443
1002952.....	665	1003022.....	226	1003087.....	850	1003309.....	443
1002953.....	665	1003023.....	226	1003088.....	850	1003310.....	443
1002954.....	665	1003024.....	470	1003090.....	853	1003311.....	443
1002955.....	665	1003025.....	470	1003091.....	856	1003312.....	443
1002956.....	599	1003026.....	470	1003092.....	856	1003313.....	443
1002957.....	599	1003027.....	470	1003093.....	854	1003314.....	443
1002958.....	599	1003028.....	079	1003094.....	850	1003316.....	218
1002959.....	599	1003029.....	079	1003095.....	850	1003317.....	218
1002960.....	271	1003030.....	078	1003096.....	856		
1002961.....	271	1003031.....	078	1003097.....	854	<b>1003400</b>	
1002962.....	220	1003032.....	079	1003098.....	855	1003416.....	696
1002964.....	220	1003033.....	079	1003099.....	856	1003417.....	696
1002965.....	312	1003034.....	245			1003418.....	697
1002967.....	289	1003035.....	245	<b>1003100</b>		1003419.....	697
1002968.....	289	1003036.....	399	1003100.....	855	1003420.....	710
1002969.....	343	1003037.....	399	1003101.....	848	1003421.....	710
1002970.....	343	1003038.....	399	1003102.....	846	1003422.....	684
1002971.....	343	1003039.....	399	1003104.....	833	1003423.....	684
1002973.....	343	1003040.....	305	1003105.....	833	1003424.....	685
1002974.....	343	1003041.....	305	1003106.....	830	1003425.....	685
1002975.....	343	1003042.....	305	1003107.....	185	1003426.....	705
1002976.....	343	1003043.....	305			1003427.....	705
1002977.....	343	1003044.....	161	<b>1003200</b>		1003428.....	201
1002978.....	343	1003045.....	161	1003254.....	835	1003429.....	201
1002979.....	382	1003046.....	161	1003275.....	179	1003430.....	201
1002980.....	382	1003047.....	161	1003276.....	179	1003431.....	201
1002981.....	382	1003048.....	163	1003277.....	179	1003432.....	133
1002982.....	388	1003049.....	163	1003278.....	179	1003435.....	128
1002983.....	388	1003050.....	163	1003279.....	179	1003436.....	129
1002984.....	388	1003051.....	163	1003280.....	179	1003437.....	696
1002985.....	273	1003052.....	305	1003281.....	179	1003438.....	697
1002986.....	273	1003053.....	305	1003282.....	179	1003439.....	710
1002987.....	273	1003054.....	305	1003283.....	325	1003440.....	684
1002989.....	664	1003055.....	305	1003284.....	325	1003441.....	685
1002990.....	664	1003057.....	427	1003285.....	325	1003442.....	705
1002991.....	604	1003058.....	427	1003286.....	325	1003443.....	136
1002992.....	604	1003059.....	427	1003287.....	325	1003444.....	136
1002993.....	199	1003060.....	427	1003288.....	325	1003447.....	637
1002994.....	820	1003061.....	427	1003289.....	325	1003448.....	637
1002996.....	792	1003062.....	427	1003290.....	325	1003449.....	713
1002997.....	792	1003063.....	427	1003291.....	489	1003450.....	713
1002998.....	792	1003064.....	427	1003292.....	489	1003451.....	713
1002999.....	792	1003065.....	428	1003293.....	489	1003452.....	713
		1003066.....	428	1003294.....	489	1003453.....	669
<b>1003000</b>		1003067.....	428	1003295.....	489	1003454.....	669
1003001.....	609	1003068.....	428	1003296.....	489	1003455.....	254
1003006.....	135	1003069.....	428	1003297.....	489	1003456.....	254

1003457.....	254	1004682.....	200	1004745.....	098	1004918.....	775
1003458.....	254	1004683.....	200	1004746.....	098	1004919.....	775
1003459.....	255	1004684.....	477	1004747.....	663	1004920.....	775
1003460.....	255	1004685.....	477	1004748.....	663	1004921.....	775
1003466.....	389	1004686.....	496	1004749.....	585	1004922.....	775
1003467.....	238	1004687.....	496	1004750.....	585	1004923.....	775
1003468.....	238	1004688.....	496	1004751.....	585	1004924.....	776
1003492.....	277	1004689.....	496	1004757.....	619	1004925.....	776
1003493.....	277	1004690.....	471	1004759.....	158	1004926.....	776
		1004691.....	471	1004760.....	158	1004927.....	777
<b>1003500</b>		1004692.....	471	1004761.....	158	1004928.....	777
1003518.....	718	1004693.....	471	1004762.....	158	1004929.....	777
1003519.....	718	1004694.....	448	1004763.....	158	1004930.....	777
1003520.....	088	1004695.....	448	1004764.....	158	1004931.....	777
1003521.....	088	1004696.....	448	1004765.....	159	1004937.....	474
1003523.....	089	1004697.....	449	1004766.....	159	1004938.....	474
1003524.....	089	1004698.....	449	1004767.....	159	1004939.....	477
1003525.....	176	1004699.....	449	1004768.....	159	1004940.....	477
1003526.....	176			1004769.....	473	1004941.....	477
1003527.....	177	<b>1004700</b>		1004770.....	473	1004942.....	477
1003528.....	177	1004700.....	367	1004771.....	473	1004943.....	477
1003530.....	165	1004701.....	367	1004772.....	473	1004944.....	477
1003532.....	165	1004702.....	367	1004776.....	832	1004957.....	719
1003535.....	595	1004703.....	366	1004780.....	835	1004969.....	192
1003536.....	595	1004704.....	366	1004781.....	835	1004970.....	072
1003537.....	595	1004705.....	366	1004782.....	835	1004971.....	260
1003538.....	595	1004706.....	250	1004783.....	529	1004972.....	848
1003539.....	688	1004707.....	250	1004784.....	529	1004973.....	848
		1004708.....	793	1004785.....	529	1004974.....	848
		1004709.....	793				
<b>1004600</b>		1004710.....	793	<b>1004800</b>		<b>1005000</b>	
1004649.....	719	1004711.....	793	1004889.....	772	1005075.....	848
1004650.....	690	1004712.....	794	1004890.....	772	1005076.....	848
1004651.....	682	1004713.....	794	1004893.....	773	1005077.....	848
1004652.....	620	1004714.....	794	1004894.....	773	1005078.....	848
1004653.....	719	1004716.....	795	1004895.....	773	1005079.....	848
1004654.....	608	1004717.....	795	1004896.....	781	1005080.....	848
1004655.....	608	1004718.....	795	1004897.....	781	1005081.....	849
1004657.....	192	1004719.....	795	1004898.....	781	1005082.....	849
1004660.....	193	1004720.....	796	1004899.....	781	1005083.....	849
1004661.....	193	1004721.....	796			1005085.....	362
1004662.....	193	1004722.....	797	<b>1004900</b>		1005086.....	362
1004663.....	193	1004723.....	797	1004900.....	782	1005087.....	363
1004664.....	331	1004725.....	798	1004901.....	782	1005088.....	363
1004665.....	331	1004726.....	801	1004902.....	783	1005089.....	714
1004666.....	315	1004727.....	799	1004903.....	783	1005090.....	714
1004667.....	315	1004730.....	261	1004904.....	783		
1004668.....	445	1004731.....	261	1004905.....	781		
1004669.....	445	1004732.....	208	1004906.....	781		
1004670.....	233	1004733.....	211	1004907.....	781		
1004671.....	233	1004734.....	800	1004908.....	781		
1004672.....	107	1004735.....	800	1004909.....	782		
1004673.....	107	1004736.....	800	1004910.....	782		
1004674.....	098	1004737.....	802	1004911.....	783		
1004675.....	098	1004738.....	196	1004912.....	782		
1004676.....	098	1004739.....	196	1004913.....	782		
1004677.....	703	1004740.....	217	1004914.....	782		
1004678.....	650	1004741.....	217	1004915.....	782		
1004679.....	650	1004742.....	217	1004916.....	782		
1004680.....	575	1004743.....	217	1004917.....	782		
1004681.....	575	1004744.....	098				



1001893 300

1001891 301

1001896 300

1001900 300



# NEW NUMINOS

## LIGHTING SYSTEM

NUMINOS S, DL .....	26-27
NUMINOS M, DL .....	28-29
NUMINOS L, DL .....	30-31
NUMINOS XL, DL .....	32-33
NUMINOS MOVE M, DL.....	34-35
NUMINOS MOVE L, DL.....	36-37
NUMINOS MOVE XL, DL.....	38-39
NUMINOS, DL accessories .....	40-41
NUMINOS S, 3-circuit .....	42-43
NUMINOS M, 3-circuit .....	44-45
NUMINOS L, 3-circuit .....	46-47
NUMINOS S, CW.....	48-49
NUMINOS M, CL .....	50-51
NUMINOS L, CL .....	52-53
NUMINOS S, CL .....	54-55
NUMINOS M, CL .....	56-57
NUMINOS L, CL .....	58-59
NUMINOS S, PD.....	60-61
NUMINOS M, PD .....	62-63
NUMINOS L, PD .....	64-65

## 1-CIRCUIT

1-CIRCUIT RECESSED TRACK .....	526
1-CIRCUIT RECESSED TRACK accessories .....	526
1-CIRCUIT SURFACE-MOUNTED TRACK .....	528
1-CIRCUIT SURFACE-MOUNTED TRACK accessories .....	529

## 3-CIRCUIT

<b>EUTRAC®</b>	
EUTRAC® 3-CIRCUIT SURFACE-MOUNTED TRACK .....	501
EUTRAC® 3-CIRCUIT SURFACE-MOUNTED TRACK accessories .....	502, 503
EUTRAC® 3-CIRCUIT RECESSED TRACK .....	505
EUTRAC® 3-CIRCUIT RECESSED TRACK accessories .....	505

### S-TRACK

S-TRACK 3-CIRCUIT SURFACE-MOUNTED TRACK DALI.....	474, 475
S-TRACK 3-CIRCUIT SURFACE-MOUNTED TRACK DALI accessories .....	476, 477

## A

ABRIDOR 60/100 Pole .....	604
ABRIDOR SENSOR WL.....	664
ABRIDOR WL .....	664
ACCANTO CL, E27 .....	284
ACCANTO PD, E27 .....	139
ACCANTO SPOT SQUARE WL, E27 .....	246
ACCANTO WL, E27 .....	247

### ACCESSORIES

1-10V Dimmer 10W .....	831
Cable clamp .....	840
Cable extension .....	842
Ceiling hook.....	840
Ceiling rosette.....	841
COMPENSATION MODULE.....	833
Connector box.....	843
Connector strip 3 outlets.....	842
DALI Controller 24V DC .....	830
DALI Interface 0-10V + on/off .....	830
DALI Universal Dimmer 10-300W .....	830
DALI Universal Dimmer 3-25W .....	830
Double-sided tape .....	842
GU10 socket.....	842
GU10 socket with connection box and quick clamp .....	842

LED driver 1000mA   40W .....	834
LED driver 1000mA   40W incl. strain relief.....	839
LED driver 1050mA   40W incl. strain relief.....	835
LED driver 200mA   6-8.4W incl. strain relief ..	835
LED driver 250mA   10W.....	835
LED driver 320mA   3W incl. strain relief .....	838
LED driver 350mA   10W.....	833
LED driver 350mA   15W.....	833
LED driver 350mA   3W incl. strain relief .....	838
LED driver 350mA   6W .....	833
LED driver 350mA   9W incl. strain relief .....	838
LED driver 350mA incl. strain relief .....	838
LED driver 500/600/700mA   30W incl. strain relief .....	835
LED driver 500mA   15W.....	834
LED driver 500mA   9W incl. strain relief .....	838
LED driver 700mA   10W incl. strain relief.....	834
LED driver 700mA   11W incl. strain relief.....	839
LED driver 700mA   39W incl. strain relief.....	834
LED driver 700mA   3W incl. strain relief .....	839
LED driver 700mA   40W incl. strain relief.....	834
LED driver 700mA   40W incl. strain relief.....	839
LED driver 700mA   6W .....	834
LED driver 800/900/1050mA   40W incl. strain relief.....	835
LED driver DALI 350-700mA   20W incl. strain relief.....	837
LED driver DALI 250-700mA   40W incl. strain relief .....	837
LED driver DALI 350-1050mA   60W incl. strain relief.....	837
LED driver DALI 700-1500mA   50W incl. strain relief.....	837
LED driver VALETO® 1050mA   45W incl. strain relief .....	839
SLV VALETO® 350/500/700mA   15W, LED driver.....	835
LED power supply 12V/24V DC   12W.....	831
LED power supply 12V/24V DC   12W round..	831
LED power supply 12V/24V DC   20W.....	831
LED power supply 24V   100W.....	832
LED power supply 24V   100W.....	833
LED power supply 24V   50W.....	833
LED power supply 24V DC   100W.....	832
LED power supply 24V DC   100W.....	832
LED power supply 24V DC   150W.....	832
LED power supply 24V DC   150W.....	832
LED power supply 24V DC   20W.....	832
LED power supply 24V DC   36W.....	831
LED power supply 24V DC   60W .....	831
Stopper for wire rope .....	841
Textile cable 3-pole, 3 x 0.75 mm <sup>2</sup> , 10m.....	841
Transformer 12V AC   10VA IP44 .....	828
Transformer 12V AC   60VA .....	830
Transformer 12V AC   60VA IP44 .....	828
Transformer 12V AC   150VA .....	830
Transformer 12V AC   105VA .....	828
Transformer 12V AC   300VA.....	828
Transformer TENSEO 12V AC   50VA.....	829
Transformer TENSEO 12V AC   105VA.....	829
Transformer TENSEO 12V AC   210VA.....	829
T-connector box.....	843
Wire rope suspension.....	841

ADEGAN FL, E27 .....	567
ADEGAN MANILA FL, E27 .....	566
ADI EL .....	732
ADJUST 135 EL, square/round, QPAR51 .....	753
ADJUST 190 EL, square/round, QR111.....	753
ADJUST 265 EL, round, HIT-CE .....	753
AINOS CW.....	712
AINOS CW SENSOR.....	712
AINOS CW SENSOR, square 713	
AINOS CW, square 713	

### AIXLIGHT®

AIXLIGHT® 150 PD, R2 Office, PHASE.....	173
AIXLIGHT® PD, R2, double, QPAR111 .....	174
AIXLIGHT® PD, R2, quad, QPAR111 .....	174
AIXLIGHT® PRO 50 LED Module .....	438
AIXLIGHT® PRO 50 QPAR51 Module.....	438
AIXLIGHT® PRO 50 accessories .....	438
AIXLIGHT® PRO EL, QPAR111 Module.....	439
AIXLIGHT® PRO accessories.....	439

AKALO D83 EL, PHASE .....	406
ALAMEA EL .....	452
ALPA CONE 100 Pole, E27 .....	576
ALPA MUSHROOM 45/75 Pole, E27 .....	576
ALTRA DICE CL, QPAR51 .....	316
ALTRA DICE CW, double, QPAR51 .....	316, 332
ALTRA DICE TRACK 1-circuit, QPAR51 .....	517
ALTRA DICE TRACK 3-circuit, QPAR51 .....	479
ANDREAS WL, QT-DE12.....	198
ANELA CL, PHASE .....	313
ANELA Display.....	275
ANELA PD, PHASE .....	130
ANGOLUX SENSOR WL .....	667
ANGOLUX SOLAR WL .....	667
ANGOLUX WL .....	667
ANILA EASYTEC® II, QPAR51 .....	536
ANINDA 120 EL .....	453
ANINDA 60 EL .....	453
APONI 90/120 Pole, PHASE.....	577
APONI WL, PHASE .....	645
ARLINA 60/130 WL.....	225
AROSA PD, 1.25m, PHASE.....	111
AROSA PD, 2m, PHASE .....	111
ARROCK ARC Pole, QPAR51.....	590
ARROCK GRANITE 40/70 Pole, square, E27 ..	589
ARROCK SLOT Pole, QPAR51 .....	600
ARROCK STONE 50/75 Pole.....	600
ASMARA LV, QR-C51 .....	544
ASSO 300 WL .....	223
ASSO 300 WL, PHASE .....	223
ASSO 70 WL .....	222
ASSO WL, PHASE .....	223
ASTINA CL, QPAR51 .....	312
ASTINA PD, QPAR51 .....	123
ASTINA STEEL WL.....	681
ASTINA STEEL WL, QPAR51.....	681
ASTINA UP/DOWN WL, QPAR51 .....	232
ASTINA WL, QPAR51 .....	680
ASTO CW, double, QPAR51 .....	347
ASTO CW, quad, QPAR51.....	347
ASTO CW, single, QPAR51.....	347
ASTO CW, triple, QPAR51 .....	347
ASTO QPAR51 .....	347
ASTO TUBE CW, double, QPAR51 .....	341
ASTO TUBE CW, QPAR51.....	341
ASTO TUBE CW, single, QPAR51.....	341
ASTO TUBE CW, triple, QPAR51 .....	341
AVENTO 110 PD.....	113
AVENTO 30 PD.....	113
AVO CW, double, QPAR51 .....	345
AVO CW, QPAR51 .....	345
AVO CW, quad, QPAR51.....	345
AVO CW, single, QPAR51.....	345
AVO CW, triple, QPAR51 .....	345
AVO TRACK 1Ph., QPAR51.....	511
AVO TRACK 3Ph., QPAR51.....	478

## B

BASKET WL, E27 .....	199
BATO 35 CW, E27.....	191
BATO 35 CW, PHASE .....	191
BATO 35 PD, E27 .....	116
BATO 35 PD, PHASE .....	116
BATO 45 CW, E27.....	286
BATO 45 CW, PHASE .....	286
BATO 45 PD, E27 .....	117
BATO 45 PD, PHASE .....	116

### BATTEN LED

BATTEN LED 220-240V ~50/60Hz .....	805
BATTEN LED 220-240V ~50/60Hz accessories.....	805

BEDSIDE EL, left.....	390
BEDSIDE EL, right.....	390
BENA 120 CW .....	369
BENA 150 CW .....	369
BENDO 80/220 Pole, PHASE.....	602
BENDO WL, PHASE .....	662
BIG NAILS 50/80 Pole.....	580
BIG NAILS 50/80 Pole, E27 .....	580
BIG NAILS PLUS 50/80 Pole, E27 .....	579
BIG NAILS WL, E27 .....	647
BIG NAUTILUS SP, round, QPAR51.....	618

BIG PLOT Cover, 2 slots .....	747
BIG PLOT Cover, 4 slots .....	747
BIG PLOT Module .....	746
BIG QUAD UP/DOWN WL .....	687
BIG QUAD WL .....	239, 672
BIG SUN PD, E27 .....	137
BIG THEO FLOOD UP/DOWN WL .....	694
BIG THEO BEAM UP/ FLOOD DOWN WL .....	695
BIG THEO CL .....	709
BIG THEO CL, QPAR111 .....	709
BIG THEO Up/Down WL, QPAR111 .....	693
BIG THEO WL .....	677
BIG THEO WL, QPAR111 .....	676
BILAS CW, single, PHASE .....	336
BIMA 1Ph., double, QPAR51 .....	515
BIMA 1Ph., single, QPAR51 .....	515
BIMA 2 EASYTEC® II, double, QPAR51 .....	535
BIMA 3Ph., double, QPAR51 .....	485
BIMA 3-circuit, single, QPAR51 .....	485
BIMA EASYTEC® II, single, QPAR51 .....	535
BOOKAT Pole, PHASE .....	592
BOX UP/DOWN WL, QT-DE12 .....	690
BOX-L WL .....	689
BOX-L WL, E27 .....	689
BRENDA TL, Wireless charging .....	075
BRICK DOWNUNDER EL .....	730
BRICK DOWNUNDER EL, E14 .....	730
BRICK EL, asymmetrical .....	733
BRICK EL, symmetrical .....	733
BRICK MESH EL .....	733
BULAN CW, E14 .....	715
BULAN GRID CW, E27 .....	715

## C

C-POL Pole, E27 .....	583
C-POL WL, E27 .....	646
CARISO WL, PHASE .....	228
CHROMBO WL, PHASE .....	218
COMET LED LV .....	551
COMET LV, QR-C51 .....	551
CONE FL, E27 .....	569
CONNECTED LED PANEL 595x595mm, UGR<19 .....	458
CONNECTED LED PANEL 620x620mm, UGR<19 .....	459
CONTONE® EL, round/square, rigid, PHASE .....	399
CONTONE® EL, round/square, adjustable, PHASE .....	399
COSMIC LV, QR-C51 .....	545
COUPA FLEX WL .....	248
COUPA WL, QT14 .....	249
CUBIX FL, QPAR51 .....	569
CV SPOT SP, short .....	625
CV SPOT SP, long .....	625

## D

<b>DASAR®</b>	
DASAR® 70 EL, square, QPAR51 .....	759
DASAR® 80 EL, square/round, QPAR51 .....	759
DASAR® 215 EL, square/round, QPAR111 .....	760
DASAR® 215 EL, round, E27 .....	760
DASAR® 218 EL, QR111 .....	760
DASAR® 255 EL .....	763
DASAR® 270 EL, asymmetrical .....	763
DASAR® 270 EL, symmetrical .....	763
DASAR® 370 EL, round .....	755
DASAR® 920 EL .....	757
DASAR® EL, T16 .....	764
DASAR® EXACT 116 EL, square/round, QPAR51 .....	759
DASAR® FLAT 80 EL .....	754
DASAR® PROJECTOR SP, 12/24V .....	630
DASAR® PROJECTOR SP, 230V .....	630
DEKLED EL .....	393
DELO WL .....	659
DELWA WL .....	236, 678
DENA 30 WL, E14 .....	199
DEVIN WL, Double, PHASE .....	262
DINGILO EL, round, adjustable .....	399

DIO FLEX PLATE WL .....	258
DIO FLEX PLATE WL QPAR51 .....	257
DIRETO 60 WL, PHASE .....	217
DIRETO 90 WL, PHASE .....	217
DISPLAY .....	277
DISPLAY ADL 50 QPAR51 .....	273
DL 126 EL .....	393
DOLIX OUT EL, square, QPAR51 .....	402, 738
DOLIX OUT EL, round, QPAR51 .....	402, 738
DORISA 30 .....	265
DORISA 50 .....	265
DOWNUNDER OUT S EL .....	731
DOWNUNDER OUT M EL .....	731
DOWNUNDER OUT L EL .....	731
DOWNUNDER OUT square .....	658
DOWNUNDER OUT round .....	658
DOWNUNDER PUR 120 EL .....	383
DOWNUNDER PUR 150 EL .....	383
DOWNUNDER PUR 80 EL .....	383
DURNO .....	548

## E

<b>EASYTEC® II</b>	
EASYTEC® II, TRACK .....	539
EASYTEC® II, TRACK accessories .....	539

## ENOLA

ENOLA B CL, QPAR51 .....	313
ENOLA B CW, double, QPAR51 .....	337, 338
ENOLA B CW, single, QPAR51 .....	337
ENOLA B PD, QPAR51 .....	124, 523
ENOLA B TRACK 1-circuit, QPAR51 .....	514
ENOLA B WL, QPAR51 .....	232, 252
ENOLA C CL .....	315
ENOLA C CL, PHASE .....	315
ENOLA C Pole .....	607
ENOLA C TRACK 1-circuit .....	521
ENOLA C TRACK 3-circuit .....	483
ENOLA L ROUND UP/DOWN S WL .....	685
ENOLA L ROUND UP/DOWN M WL .....	685
ENOLA L ROUND UP/DOWN L WL .....	685
ENOLA PD, E27 .....	125
ENOLA ROUND S CL .....	705
ENOLA ROUND S WL, single .....	684
ENOLA ROUND M CL .....	705
ENOLA ROUND M WL, single .....	684
ENOLA ROUND L CL .....	705
ENOLA ROUND L WL, single .....	684
ENOLA SQUARE S CL .....	710
ENOLA SQUARE S UP/DOWN WL .....	697
ENOLA SQUARE S WL, single .....	696
ENOLA SQUARE M CL .....	710
ENOLA SQUARE M UP/DOWN WL .....	697
ENOLA SQUARE M WL, single .....	696
ENOLA SQUARE L UP/DOWN WL .....	697
ENOLA SQUARE L CL .....	710
ENOLA SQUARE L WL, single .....	696

ESKINA 30/80 Pole, PHASE .....	607
ESKINA D Display, PHASE .....	700
ESKINA FRAME 45/75 Pole, single .....	585
ESKINA FRAME 75 Pole, double .....	585
ESKINA FRAME WL .....	663
ESKINA FRAME WL, double .....	663
ESKINA SPOT CW, PHASE .....	721
ESKINA SPOT SENSOR CW, PHASE .....	721
EURO CUBE 3-circuit .....	487
EURO SPOT TRACK 1-circuit .....	516
EURO SPOT TRACK 1-circuit QPAR51 .....	516
EURO SPOT TRACK 3-circuit .....	495
EURO SPOT TRACK 3Ph., QPAR111 .....	494
EURO SPOT TRACK 3-circuit, QPAR51 .....	494

## F

F-POL Pole, E27 .....	583
F-POL WL, E27 .....	646

## FENDA

FENDA BOW BASIS FL, E27 .....	079
FENDA ceiling rosette, E27 .....	282
FENDA FL, E27 .....	078, 079
FENDA glass shade .....	102

FENDA half shade .....	202
FENDA Ø 15 cm, round .....	080, 104
FENDA Ø 20cm, round .....	245
FENDA Ø 30 cm, round .....	080, 105, 283
FENDA Ø 40 cm, round .....	081, 102
FENDA Ø 45 cm, round .....	081, 105, 283
FENDA Ø 70 cm, round .....	081, 105, 283
FENDA PD, E27 .....	102
FENDA TL, E27 .....	078, 079
FENDA WL, Basis, E27 .....	202, 244
FENDA WL, E27 .....	245

FERA 25 CL .....	289
FERA 25 CL, DALI .....	289
FILI, Terminal WL, QPAR51 .....	272
FITU CUBE WL, E27 .....	196
FITU CW, E27 .....	333
FITU FL, E27 .....	085
FITU MIX & MATCH accessories .....	098
FITU PD, E27 .....	094, 095, 096, 097
FITU TL, E27 .....	070
FITU wall bracket .....	200
FITU WL, E27 .....	200
FLAC BEAM® SP .....	634
FLAT FRAME BASIC EL, QT9 .....	386
FLAT FRAME CURVE EL, QT9 .....	385
FLATT 65/100 Pole .....	599
FLATT SENSOR WL .....	665
FLATT WL .....	665
FORCHINI 50 PD, E27 .....	118
FORCHINI 70 PD, E27 .....	118
FORCHINI M 40 PD, E27 .....	119
FORCHINI M 40 TRACK 1-circuit, E27 .....	525
FORCHINI M 40 TRACK 3-circuit, PD, E27 .....	499
FORCHINI M 50 PD, E27 .....	119
FRAME BASIC EL .....	386
FRAME BASIC EL, HV .....	386
FRAME CURVE EL .....	385
FRAME CURVE EL, HV .....	385

## G

GALEN 60/120 SP .....	637
GALEN 100 SP .....	636
GIMBLE IN 68 EL .....	446
GIMBLE IN 100 EL .....	446
GIMBLE IN 150 EL .....	446
GIMBLE IN 175 EL .....	447
GIMBLE OUT EL .....	752
GLASSA CW, square, E27 .....	361
GLENOS PD, 1m, 1-10V .....	168
GLENOS PD, 2m, 1-10V .....	168
GLENOS® 60 .....	267
GLOO PURE 27/44/70 Pole, E27 .....	574
GLOO PURE WL, E27 .....	642
GRAFIT 30/60 Pole, E27 .....	586
GRAFIT WL, E27 .....	648

## GRAZIA Profile

GRAZIA 10 Surface-mounted profile, flat .....	769
GRAZIA 10 Surface-mounted profile, standard .....	769
GRAZIA 10 EDGE surface-mounted profile .....	772
GRAZIA 10 EDGE accessories .....	773
GRAZIA 10 Recessed profile 769 .....	
GRAZIA 10 Accessories 770, 771 .....	
GRAZIA 20 Surface-mounted profile, flat .....	775
GRAZIA 20 Surface-mounted profile, standard .....	775
GRAZIA 20 Recessed profile .....	776
GRAZIA 20 Accessories .....	777, 778, 779
GRAZIA 60 Surface-mounted profile .....	781
GRAZIA 60 Recessed profile .....	781
GRAZIA 60 Accessories .....	782, 783

## GRAZIA LED strips

GRAZIA FLEXSTRIP LED, 24V .....	792, 793
GRAZIA IP FLEXSTRIP, 24V .....	800
GRAZIA IP FLEXSTRIP, RGBW, 24V .....	802
GRAZIA IP FLEXSTRIP, Tunable white, 24V .....	801
GRAZIA PRO FLEXSTRIP, 24V .....	794, 795
GRAZIA PRO FLEXSTRIP, RGBW, 24V .....	799
GRAZIA PRO FLEXSTRIP, Tunable white, 24V .....	798
GRAZIA PRO MAX FLEXSTRIP, 24V .....	796, 797

**H**

H-LIGHT EL, oval, PHASE.....	400
H-LIGHT EL, PHASE.....	401
H-LIGHT EL, round, PHASE.....	400
H-POL 30/60 Pole.....	596
H-POL Twin 30/60 Pole.....	597

**H-PROFIL**

H-PROFIL 2m.....	785
H-PROFIL 2m accessories.....	786, 787

HANG UP 120 PD, PHASE.....	164
HELIA 30 PD.....	126
HELIA 30 PD, PHASE.....	127
HELIA 40 PD.....	126
HELIA 40 PD, PHASE.....	127
HELIA 50 TRACK 1-circuit.....	521
HELIA 50 TRACK 3-circuit.....	482
HELIA AMBIENT 35 PD.....	128
HELIA AMBIENT 35 PD, PHASE.....	129
HELIA CW, double, PHASE.....	339, 723
HELIA CW, single, PHASE.....	339, 723
HELIA EL.....	391
HELIA Pole, double, PHASE.....	611, 613
HELIA Pole, single, PHASE.....	610, 613
HELIA SENSOR Single.....	610
HELIA SPOT L SP, single, PHASE.....	631
HELIA SPOT S SP, single, PHASE.....	631
HORN EL, QPAR51.....	415
HORN MAGNA EL.....	416
HORN MEDI EL.....	416
HORN MINI EL.....	416
HORN-A EL, QPAR51.....	413
HORN-O EL, QPAR51.....	413
HORN-T EL, QPAR111.....	414
HORN-T EL, QPAR51.....	413

**I**

I-PENDANT PRO PD, 1195x295mm, 1-10V... 163	
I-PENDANT PRO PD, 1195x295mm, DALI.... 163	
I-PENDANT PRO PD, 1195x295mm,	
UGR<19, 1-10V.....	163
IMPERVA 120 CW.....	365
IMPERVA 150 CW.....	365
INDA CW, QPAR51.....	330
IPERI 50 Pole.....	605
IPERI WL.....	668
IVED GOOSE WL, Rosette.....	259

**K**

KADUX EL, double, 1-10V.....	437
KADUX EL, double, PHASE.....	436
KADUX EL, double, QPAR111.....	435
KADUX EL, double, QPAR51.....	434
KADUX EL, single, 1-10V.....	437
KADUX EL, single, PHASE.....	436
KADUX EL, single, QPAR111.....	435
KADUX EL, single, QPAR51.....	434
KADUX EL, triple, PHASE.....	436
KADUX EL, triple, QPAR51.....	434
KALU CW, double, PHASE.....	352
KALU CW, double, QPAR111.....	350
KALU CW, PHASE.....	352
KALU CW, QPAR111.....	350
KALU CW, quad, PHASE.....	353
KALU CW, quad, QPAR111.....	350
KALU CW, single, PHASE.....	352
KALU CW, single, QPAR111.....	350
KALU CW, triple, PHASE.....	352
KALU CW, triple, QPAR111.....	350
KALU TRACK 1-circuit, QPAR111.....	519
KALU TRACK 1-circuit, PHASE.....	519
KALU TRACK 3-circuit, PHASE.....	493
KALU TRACK 3-circuit, QPAR111.....	492
KALU TRACK 3-circuit, QR111.....	492
KAMUELA ECO EL, round, PHASE.....	404, 743
KANO EASYTEC® II, QPAR51.....	536
KARDAMOD CL, square, double,	
QPAR111.....	323
KARDAMOD CL, square, single,	
QPAR111.....	323

KARDAMOD CL, round, double, QPAR111....	324
KARDAMOD CL, round, single, QPAR111.....	324
KARPO 30 CW, single.....	253, 334
KARPO 30 CW, single, PHASE.....	334
KARPO 30 EL.....	391
KARPO FL.....	083
KARPO MAGN CW, single, PHASE.....	250
KARPO TL.....	082
KARPO WL.....	253
KENKUA SPOT WL, E27.....	246
KENKUA WL, E27.....	246
KERAS ELT WL, E27.....	651
KINI EL, PHASE.....	737
KIROCONE TL, E27.....	564

**L**

L-LINE 120.....	268
L-LINE 60.....	268
L-LINE OUT 15 WL, vertical.....	688
L-LINE OUT 30 FL, vertical.....	595
L-LINE OUT 50/80 Pole, horizontal.....	595
L-LINE OUT 60 FL, vertical.....	595
LED PANEL 300x120mm.....	461
LED PANEL 600x600mm.....	461
LED PANEL 620x620mm.....	460, 461
LED SAIL WL.....	229
LED SPIKE SP.....	622
LED SPOT SP.....	719
LENITO TRACK 3-circuit.....	481
LENITO WL.....	242, 275
LIGHT EYE® 150 3Ph., PD, QPAR111.....	499
LIGHT EYE® 150 PD, QPAR111.....	108, 523
LIGHT EYE® 150 TRACK 3-circuit, QPAR111... 480	
LIGHT EYE® 150 TRACK EASYTEC® II, PD,	
QPAR111.....	537
LIGHT EYE® 150 TRACK EASYTEC® II,	
QPAR111.....	537
LIGHT EYE® 90 1Ph., QPAR51.....	512
LIGHT EYE® 90 PD, GU10.....	108
LIGHT PIPE 60/90/140 Pole, PHASE.....	087, 578
LIGHTPOINT EL.....	392

**LIGHTBULB**

LED A60 E27.....	852, 853, 854
LED A60 E27, CCT.....	852
LED A60 E27, Mirrorhead, chrome.....	855
LED A60 E27, Mirrorhead, gold.....	855
LED A60 E27, RGBW.....	852
LED C35 E14.....	852
LED Filament G9.....	846
LED FRISBEE E27.....	854
LED G125 E27.....	856
LED G125 E27, Mirrorhead, gold.....	856
LED G125 E27, Smoked glass.....	856
LED G95/G125 E27.....	856
LED G95/G125 E27, Smoked glass.....	856
LED GU10.....	848, 849
LED PAR38 E27.....	857
LED QPAR111 GU10.....	850, 851
LED QPAR111 GU10, CCT.....	850
LED QPAR111 GU10, RGBW.....	850
LED QPAR51 GU10.....	848, 849
LED QR111 G53.....	851
LED QR51 GU5.3.....	846
LED QT14 G9.....	846
LED QT-DE12 R7S 118mm.....	846
LED QT-DE12 R7S 78mm.....	846
LED ST58 E27.....	855
LED ST64 E27.....	855
LED T32 E27.....	855
LED T32 FILAMENT GU10.....	848
LED T38 E27.....	853
LED T45 E27.....	853
LED TCR-TSE GX53.....	857
T16 G5.....	857

LIPA CW, PHASE.....	716
LIPSY® 30 CW, Connected.....	356
LIPSY® 30 CW, Dome.....	357
LIPSY® 30 CW, Drum.....	358
LIPSY® 40 CW, Connected.....	356
LIPSY® 40 CW, Dome.....	357
LIPSY® 40 CW, Drum.....	358
LIPSY® 40 CW, Drum, DALI.....	359

LIPSY® 50 CW, Connected.....	356
LIPSY® 50 CW, Dome.....	357
LIPSY® 50 CW, Drum.....	358
LIPSY® 50 CW, Drum, DALI.....	359
LIPSY® CW, Connected.....	356
LIPSY® CW, Dome.....	357
LIPSY® CW, Drum.....	358
LIPSY® CW, Drum, DALI.....	359
LISENNE 40/70 Pole, E27.....	572
LISENNE PD, E27.....	131
LISENNE WL, E27.....	197
LOGS 40/70 Pole.....	586
LOGS IN L WL, PHASE.....	213
LOGS IN WL.....	212
LOGS IN WL, PHASE.....	212
LOGS WL.....	692
LONG GRILL CW.....	371

**M****M-TRACK**

M-TRACK adjustable.....	556
M-TRACK Spot.....	556
M-TRACK TRACK.....	557
M-TRACK TRACK accessories.....	557

MAGANDA TL.....	072
MAGANDA WL.....	260
MALANG CL, E27.....	308
MALANG CW.....	121
MALO Display WL.....	276
MALU CL.....	711
MALU Pole.....	606
MALU WL.....	670
MANA 40 Shade, round.....	193
MANA 60 Shade, round.....	193
MANA BASE Round.....	192
MANA BASE WL, round, PHASE.....	192
MANA OUT WL, PHASE.....	688
MANA Shade.....	205, 207
MANA WL, Basis.....	206
MANA WL, Basis, PHASE.....	204, 206
MARONA CW, PHASE.....	360
MARYLIN 40/60/90 WL.....	262
MECANICA PLUS FL.....	086
MECANICA PLUS TL.....	086

**MEDO**

MEDO 30 AMBIENT CW, DALI.....	150, 300
MEDO 30 AMBIENT CW, PHASE.....	148, 298
MEDO 30 CL, 1-10V.....	146, 296
MEDO 30 CL, PHASE.....	144, 294
MEDO 30 EL, FRAME.....	456
MEDO 30 EL, frameless.....	454
MEDO 40 AMBIENT CW, DALI.....	150, 300
MEDO 40 AMBIENT CW, PHASE.....	149, 299
MEDO 40 CL, 1-10V.....	146, 296
MEDO 40 CL, PHASE.....	145, 295
MEDO 40 EL, FRAME.....	456
MEDO 40 EL, frameless.....	455
MEDO 60 AMBIENT CW, DALI.....	150, 300
MEDO 60 AMBIENT CW, PHASE.....	149, 299
MEDO 60 CL, 1-10V.....	146, 296
MEDO 60 CL, square.....	302
MEDO 60 CL, square, 1-10V.....	152
MEDO 60 CL, square, DALI.....	153, 303
MEDO 60 EL, FRAME.....	456
MEDO 60 EL, frameless.....	455
MEDO 90 AMBIENT CL, DALI.....	151, 301
MEDO 90 AMBIENT CL, PHASE.....	149, 299
MEDO 90 CL, 1-10V.....	147, 297
MEDO 90 EL, FRAME.....	457
MEDO 90 EL, frameless.....	455
MEDO RING 60 PD, DALI.....	155
MEDO RING 60 PD, 1-10V.....	154
MEDO RING 90 PD, 1-10V.....	154

MELAN CW, E27.....	360
MERADO FLOOD TRACK 3-circuit, PHASE... 481	
MERADO FLOOD WL, PHASE.....	243
MERIDIAN BOX SENSOR WL, E27.....	655
MERIDIAN BOX WL, E27.....	654, 655
MERIDIAN WL, E27.....	651
MIBO UP/DOWN WL, QT14.....	264
MOBALA EL.....	388

MOLAT CL, E27.....	702
MOLAT PD, E27.....	563
MOLAT Pole, E27.....	578
MOLAT WL, E27.....	642
MYRA CW, single, QPAR51.....	722
MYRA DISPLAY WL, curved, QPAR51.....	701
MYRA SPOT Double, GU10.....	613
MYRA UP/DOWN WL, QPAR51.....	679
MYRA WL, double, QPAR51.....	722

**N**

NAGY 75 CL, QPAR51.....	312
NAUTILUS 10 SP, square.....	621
NAUTILUS 10 SP, round, QPAR51.....	618, 620
NAUTILUS 10 SPOT LED SP.....	629
NAUTILUS 10 SPOT SP, QPAR51.....	629
NAUTILUS 10 WL, square.....	720
NAUTILUS 25 WL, QPAR51.....	720
NAUTILUS SP, QR-C51.....	627
NAUTILUS SPOT SP, PAR38, E27.....	629
NAUTILUS WL, square.....	720
NEPRO DISPLAY QT-DE12.....	276
NEW FLAT WL, RGB-W.....	226

**NEW TRIA**

NEW TRIA 110 Single, square, CS, PHASE.....	433
NEW TRIA 110 Single, round, CS, PHASE.....	432
NEW TRIA 150 Single, square, CS, 1-10V.....	433
NEW TRIA 150 Single, square, LS, QPAR111.....	425
NEW TRIA 150 Single, round, CS, 1-10V.....	433
NEW TRIA 150 Single, round, LS, QPAR111.....	425
NEW TRIA 155 Double, CS.....	431
NEW TRIA 155 Double, CS, QPAR51.....	424
NEW TRIA 300 Double, CS, QPAR111.....	425
NEW TRIA 45 Single, square, CS.....	426
NEW TRIA 45 Single, round, CS.....	426
NEW TRIA 68 EL, Single, round, CS, PHASE.....	428
NEW TRIA 68 Single, square, CS.....	427
NEW TRIA 68 Single, square, CS, PHASE.....	428
NEW TRIA 68 Single, square, CS/LS, PHASE.....	429
NEW TRIA 68 Single, square, CS/LS, QPAR51.....	420
NEW TRIA 68 Single, round, CS.....	427
NEW TRIA 68 Single, round, CS/LS, PHASE.....	429
NEW TRIA 68 Single, round, CS/LS, QPAR51.....	420
NEW TRIA 77 Single, square, CS.....	430
NEW TRIA 77 Single, round, CS.....	430
NEW TRIA 78 Single, square, CS, QPAR51.....	423
NEW TRIA 78 Single, square, LS, QPAR51.....	422
NEW TRIA 78 Single, round, CS, QPAR51.....	423
NEW TRIA 78 Single, round, LS, QPAR51.....	422
NEW TRIA 78 XL Single, square, CS, QPAR51.....	421
NEW TRIA 78 XL Single, round, CS, QPAR51.....	421

NOBLO CW, double, PHASE.....	343
NOBLO CW, PHASE.....	343
NOBLO CW, single, PHASE.....	343
NOBLO CW, triple, PHASE.....	343
NOBLO SPOT 1-circuit.....	520
NOBLO SPOT 1-circuit, Triple Track Set.....	510
NOBLO SPOT 3-circuit.....	482
NOBLO SPOT LV, Rope Track.....	550
NOTAPO WL.....	382
NOYA PD, PHASE.....	165

**O**

OCCULDAS 13 DL, Indirect, PHASE.....	311
OCCULDAS 14 EL, Indirect, PHASE.....	411
OCCULDAS 23 DL, Indirect, PHASE.....	311
OCCULDAS 23 EL, Indirect, PHASE.....	411
OCULUS CL, Move, PHASE.....	445
OCULUS CL, PHASE.....	315

OCULUS CW, PHASE.....	331
OCULUS PD, single, PHASE.....	107
OCULUS UP/DOWN WL, PHASE.....	233
ONE 40 TRACK 3-circuit, DALI.....	473
ONE 40 WL, DALI.....	194
ONE 60 PD, DALI.....	157
ONE 60 PD, DALI, up/down.....	158
ONE 60 PD, PHASE, up/down.....	158
ONE 60 WL, DALI.....	194
ONE 80 PD, DALI.....	157
ONE 80 PD, DALI, up/down.....	158
ONE DOUBLE PD, DALI, up/down.....	159
ONE DOUBLE PD, PHASE, up/down.....	159
ONE TRIPLE PD, DALI.....	157
OPEN GRILL PD, Double, rotatable.....	172
OPEN GRILL PD, Single, rotatable.....	172
ORBIT LV, QR111.....	547
ORDI SENSOR WL.....	666
ORDI WL.....	666
OSSA 180 WL, QT-DE12.....	224
OSSA 300 WL, QT-DE12.....	224
OTOS GLAS Pole, E27.....	573
OUT 65 EL, round, PHASE.....	739
OUT-BEAM FRAME SP.....	718
OUT-BEAM UP/DOWN WL, QT-DE12.....	698
OUT-BEAM UP/FLOOD Down WL.....	699
OVALISK 75/100 Pole.....	575
OVALISK CL.....	703
OVALISK Sensor WL.....	650
OVALISK WL.....	650

**P**

P-LIGHT CW.....	372, 373, 375
P-LIGHT CW accessories.....	372, 373, 375
P-LIGHT EL.....	405

PANEL 60 CL, round, DALI.....	305
PANEL 60 CL, round, PHASE.....	304
PANEL 60 PD, 1-10V.....	160
PANEL 60 PD, round, DALI.....	161
PANEL CL, 1200x300mm, DALI.....	305
PANEL CL, 1200x300mm, PHASE.....	305
PANTILO 28 PD, E27.....	135
PANTILO CONVEX 29 PD, E27.....	136
PANTILO CONVEX 40 PD, E27.....	136
PARA 380 PD, E27.....	182
PARA CONE 14 1-circuit, PD, QPAR51.....	524
PARA CONE 14 1-circuit, QPAR51.....	513
PARA CONE 14 3-circuit, PD, QPAR51.....	499
PARA CONE 14 3-circuit, QPAR111.....	480
PARA CONE 20 PD, E27.....	120
PARA CONE 30 PD, E27.....	120
PARA DOME PD, E27.....	181, 183
PARA DOME Shade.....	181
PARA FLAC PD/CL.....	184
PARA FLAC PD/CL, DALI.....	185
PARA MULTI PD, DLMI.....	183
PATTA-F EL, square, PHASE.....	407, 740
PATTA-F EL, round, PHASE.....	407, 740
PATTA-I EL, square, PHASE.....	408, 409, 741, 742
PATTA-I EL, round, PHASE.....	408, 409, 741, 742
PAVANO 300x1200mm.....	463
PAVANO 600x600mm.....	463
PAVANO 620x620mm.....	463
PEMA® WL.....	240, 659, 669
PEMA® WL, E27.....	669
PHELIA 10 PD, E27.....	114
PHELIA 20 PD, E27.....	115
PHELIA 25 PD, E27.....	115
PHELIA 30 PD, E27.....	115
PHELIA FL, E27.....	084
PHELIA TL, QPAR51.....	084
PHELIA WL, QPAR51.....	251
PHOTONIA CL, E27.....	702
PHOTONIA PD, E27.....	562
PHOTONIA Pole, E27.....	573
PHOTONIA TL, E27.....	568
PHOTONIA WL, E27.....	642
PIKA EL, square, QPAR51, tiltable.....	397
PIKA EL, square, QPAR51, rigid.....	397
PIKA EL, round, QPAR51.....	397
PIKA EL, round, QPAR51, rigid.....	396
PIPOFLEX WL.....	256

**PLASTRA**

PLASTRA 101 WL, E14.....	236
PLASTRA 104 CL, E27.....	288
PLASTRA 104 WL, QT14.....	230
PLASTRA 105 CL, E27.....	288
PLASTRA 25 PD, round, TCR-TSE.....	106
PLASTRA CL, PHASE.....	288
PLASTRA CL, QPAR51.....	322
PLASTRA EL, square, QPAR51.....	395
PLASTRA EL, round, QPAR51.....	394
PLASTRA PD, QPAR51.....	124
PLASTRA SLOT WL, E14.....	215
PLASTRA WL, Cube, QT14.....	210
PLASTRA WL, Cubes.....	211
PLASTRA WL, Curve, PHASE.....	227
PLASTRA WL, Curve, QT-DE12.....	236
PLASTRA WL, semicircle.....	208
PLASTRA WL, QPAR51.....	215, 231
PLASTRA WL, square.....	190
PLASTRA WL, rectangular, QT-DE12.....	209
PLASTRA WL, round.....	190

PLYTTA.....	549
POLE PARC 90/150/200 Pole.....	584
POLE PARC CL.....	706
POLE PARC UP/DOWN WL.....	683
POLE PARC WL.....	657
POWER TRAIL-LITE® EL, square.....	749
POWER TRAIL-LITE® EL, round.....	749
PURI 3-circuit, QPAR51.....	484
PURI CW, double, QPAR51.....	349
PURI CW, QPAR51.....	349
PURI CW, quad, QPAR51.....	349
PURI CW, single, QPAR51.....	349
PURI CW, triple, QPAR51.....	349
PURI TRACK 1-circuit, QPAR51.....	511, 512
PURI TRACK 1-circuit, Triple Track Set.....	510
PURI TRACK 3-circuit, QPAR51.....	485
PURIA TRACK 1-circuit, QPAR51.....	511
PURISA WL, E27.....	199

**Q**

Q-LINE® CL, 1m, BAP, PHASE.....	306
Q-LINE® CL, 2m, BAP, PHASE.....	307
Q-LINE® PD, 1m, BAP, PHASE.....	170
Q-LINE® PD, 2m, BAP, PHASE.....	170
Q-LINE® PD, DALI, single.....	169
Q-LINE® PD, single.....	169
Q-LINE® WL.....	269
QUAD FRAME 14 WL.....	238
QUAD FRAME 19 WL.....	238
QUAD FRAME 9 WL.....	389
QUAD Pole.....	609
QUAD UP/DOWN 12 WL.....	214, 687
QUAD UP/DOWN 15 WL.....	214, 687
QUAD WL.....	239, 672
QUADRASS PD, E27.....	133
QUADRASS SPOT WL, E27.....	201
QUADRASS WL, E27.....	201
QUADRASYL 75 Pole, TCR-TSE.....	605
QUADRASYL CW, TCR-TSE.....	671
QUADRASYL WL, TCR-TSE.....	671
QUADRULO SENSOR WL, E27.....	652
QUADRULO WL, E27.....	653

**R**

RASCALI 45/65 Pole.....	593
RASCALI WL.....	660
RETRATO WL, PHASE.....	271
ROCCI EL, square.....	751
ROCCI EL, round.....	751
ROTOBALL 25 CL, E27.....	308
ROTOBALL 25/40/50 FL, E27.....	565
ROTOBALL 25/40/50 PD, E27.....	137
ROTOBALL 40 CL, E27.....	308
ROX ACRYL 30/60/90 Pole, E27.....	581
ROX ACRYL 30/60/90 Pole, PHASE.....	581
ROX CL, GX53.....	706
ROX CL, QPAR111.....	314, 706
ROX UP/DOWN WL, QPAR111.....	234, 683
ROX WL, QPAR111.....	234, 657
RUBA 27/42 CW.....	714

RUSTY® UP/DOWN WL, square	690
RUSTY® UP/DOWN WL, round	682
RUSTY® 40/70 Pole	571, 588
RUSTY® 40/70 Pole, E27	571, 588
RUSTY® CONE 24 FL, E14	570
RUSTY® CONE 40/70 Pole, E27	570
RUSTY® PATHLIGHT 40/70 Pole	603
RUSTY® PATHLIGHT Pole, TCR-TSE	603
RUSTY® SLOT 50/80 Pole	601
RUSTY® SLOT 50/80 Pole, E27	601

**S**

SAIL WL	673
SALUNA LV, QR-C51	546
SAMRINA SP, single, GU10	619
SEDO 7 WL	220
SEDO 14 WL	220
SEDO 21 WL	220
SENDER 12 CW, square, PHASE	366
SENDER 12 CW, round, PHASE	367
SENDER 12 EL, square	449
SENDER 12 EL, round	448
SENDER 18 CW, square, PHASE	366
SENDER 18 CW, round, PHASE	367
SENDER 18 EL, square	449
SENDER 18 EL, round	448
SENDER 24 CW, square, PHASE	366
SENDER 24 CW, round, PHASE	367
SENDER 24 EL, square	449
SENDER 24 EL, round	448
SENDER CW, square, PHASE	366
SENDER CW, round, PHASE	367
SHELL 15 WL, PHASE	241
SHELL 30 WL, PHASE	241
SIGHT 115 CW	370
SIGHT 60 CW	370
SIGHT MOVE 3-circuit	496
SIGHT MOVE 3-circuit, DALI	471
SIGHT TRACK 3-circuit	483
SIGHT TRACK 3-circuit, DALI	472
SIGHT TRACK 3-circuit, PD	497
SIMA CW, square, PHASE	363
SIMA CW, square, Sensor	363
SIMA CW, round, PHASE	362
SIMA CW, round, Sensor	362
SITRA 360 CW, TCR-TSE	722
SITRA 360 Pole, TCR-TSE	612
SITRA 360 SPIKE SP, double, TCR-TSE	623
SITRA 360 SPIKE SP, single, TCR-TSE	623
SITRA CL, TCR-TSE	704
SITRA CUBE WL	691
SITRA CUBE WL, TCR-TSE	691
SITRA UP/DOWN WL	680
SITRA UP/DOWN WL, TCR-TSE	680
SITRA WL	656
SITRA WL, TCR-TSE	656
SLOTBOX 40/70 Pole	598
SLOTS 45 Pole	591
SLOTS 65 Pole	591
SLOTS WL	644
SOLASTO EL, square/round	750
SOLID CUBE WL, QT14	210
SOMNILA FLEX WL, left	255
SOMNILA FLEX WL, right	255
SOMNILA SPOT WL, left	254
SOMNILA SPOT WL, right	254
SOPRANA CL, E27	285
SOPRANA PD, E27	138
SPHERA 45 PD, PHASE	122
SPHERA 75 PD, PHASE	122
SPOODI 13 SP, SENSOR	633
SPOODI 20 SP, SENSOR	633
SPOODI 31 SP	633
SPOT 79 CW, QPAR51	330
SPOT DISPLAY E27	273
SPOT TRACK 1-circuit, E27	512
SPOT TRACK 3-circuit, E27	478
SQUARE CL, PHASE	707
SQUARE Pole 30/60/90 Pole, E27	587
SQUARE Pole 30/60/90 Pole, PHASE	587
SQUARE TURN WL, G9	686

SQUARE WL, E27	648
SQUARE WL, PHASE	648
STIX WL	251
STRUCTEC 1-circuit	522
STRUCTEC 3-circuit	490, 491
STRUCTEC 3-circuit, DALI	470
STRUCTEC ZOOM 3-circuit	491
SUN PD, E27	137
SUPROS 78 CL, PHASE	325
SUPROS 78 EL, Move, PHASE	441
SUPROS 78 EL, PHASE	440
SUPROS 78 PD	178
SUPROS 78 TRACK 3-circuit, PHASE	488
SUPROS 78 Up/Down WL, PHASE	235
SUPROS CL, Move	325
SUPROS DL	442
SUPROS DL, Move	443
SUPROS PD	179
SUPROS TRACK 3-circuit	489
SYNA SP	622
SYROS LV, QR-C51	545

**T**

TANI WL, QT-DE12	218
TEC KALU CL, double, PHASE	317
TEC KALU CL, quad, PHASE	317
TEC KALU TRACK 3-circuit, double, PHASE	486
TEC KALU TRACK 3-circuit, quad, PHASE	486
TELESKOP LV, QR-C51	544
TENORA CL, E27	285

**TENSEO low-voltage cord**

TENSEO low-voltage cord	554, 555
TENSEO low-voltage cord accessories	555

TERANG 200 CW	717
TERANG 270 CW	717
TERANG 270 CW SENSOR	717
THEO BRACKET 50/70 Pole	608
THEO BRACKET CW	719
THEO BRACKET SP	620
THEO PATHLIGHT Pole, double	608
THEO PATHLIGHT Pole, single	608
THEO UP/DOWN WL, QPAR51	216, 693
THEO WL, QPAR51	676
TODAY Display	700
TODAY PRO Display	700
TONGA® 1-circuit, PD, E14	524
TONGA® EASYTEC® II, PD, E14	538
TONGA® PD, E14	132
TONILA TL	071
TOTHEE CW, PHASE	335
TRAIL-LITE® 60 EL	748
TRAPECCO DOWN WL	670
TRAPECCO Pole	606
TRIADEM PD, E27	139
TRILEDO CL, double, square	321
TRILEDO CL, double, square, QPAR51	319
TRILEDO CL, single, square	321
TRILEDO CL, single, square, QPAR51	319
TRILEDO CL, single, round	321
TRILEDO CL, single, round, QPAR51	319
TRUKKO 60/90 WL	261
TRUKKO WL, rectangular	261
TRUKKO WL, round	261
TRUST 30/60 Pole	579

**V**

VANO WING SP, 1-10V	635
VAP 40/70/100 Pole, E27	582
VAP SLIM 30/60/90 Pole, E27	582
VARU EL	403, 737
VARU EL, QPAR51	403, 737
VERLUX EL, square, PHASE	451
VILUA S WL	674
VILUA L WL	675
VILUA UP/DOWN, WL	675
VINCELLI D PD, PHASE	111
VINCELLI D TL	072
VINCELLI D WL, PHASE	271

**W**

WALLYX WL, QPAR51	661
WETSY EL, square/round	751
WL 106 E14	263
WL 149 WL	219
WL 149 WL, QT-DE12	219
WORKLIGHT FL	088
WORKLIGHT PD, DALI	176
WORKLIGHT PLUS FL	089
WORKLIGHT PLUS PD, Switch	177
WORO EL	388







1000799 593



1001998 580





1000682 577



1003001 609



1001878 299

1001886 299



139112 547



# SYMBOLS KEY

## PRODUCT CHARACTERISTICS

Information regarding the possible **replacement** of light sources and control equipment by end users or qualified persons **without permanent damage to the light**.



- Light source can be replaced by a qualified person
- LED can be replaced by a qualified person
- Control equipment can be replaced by a qualified person



- Light source can be replaced by the end user
- LED can be replaced by the end user
- Control equipment can be replaced by the end user

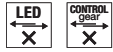

- Light source cannot be replaced
- Control equipment cannot be replaced



### Dimmable with...

- C = leading-edge **phase** dimmer
- L = trailing-edge **phase** dimmer
- Uni = universal dimmer
- 1-10V
- Dali = Dali busbar system
- Switch = switch or button



### Dim to warm

With dimmers, the light colour can be altered from cold white to warm white.



**Weight** of the product in kilogrammes (kg)

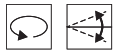

### Rotating and pivoting capacity in degrees:

- Rotation range
- Pivot range
- Gimballed



### The half beam angle

Describes the beam angle in degrees. The smaller the angle, the more concentrated the light will be.



**Pendant cable length** in cm



**Power cable length** in cm  
**Feed-in length** in cm (with open cable ends)



**Average lifespan** of a lightbulb or light source in hours



### Lumen maintenance

Describes the amount by which the luminous flux of an LED decreases during a specified period.



Indicates products that can be operated via **remote control**



### UGR = Unified Glare Rating

The lower the UGR value, the lower the psychological glare.

## SAFETY DETAILS



### Protection categories

- Protection category I/protective conductor
- Protection class II/protection through double or strengthened insulation
- Protection category III/protection through low voltage



The **IK degree of shock resistance** is a measure of the resistance of the housing of electrical equipment to mechanical stress, especially impact stress.

## APPLICATION AREA · ASSEMBLY



IP protection class  
Indicates the suitability of electrical equipment for different environmental conditions.



Allows the installation of electrical control equipment on materials whose **flammability** is not known.



**Through-wiring** possible.



**Independent converter**  
(control equipment also for use outside of lights)



Short circuit protected **safety control equipment**



- For indoor use **only**
- **Not suitable** for use indoors

## SPECIFIC DETAILS - RECESSED LIGHTS



**Shape of the installation opening**



**Product suitability** for being driven over given



**weight capacity** of the product up to specified value in tons. Measurements based on concrete installation.

## SPECIAL SYMBOLS



Indicates **products** that have been added to the catalogue for the first time



Indicates **new versions** of existing products

- New colour variant
- New product variant
- Successor



Items with this symbol are **discontinued models**



Indicates products  
· with **integrated** LEDs  
· with **lightbulb socket**



### Connected lighting

Indicates smart products that use the following protocols:  
· Zigbee® · DALI · Bluetooth



Indicates **lights with a movement sensor**  
(microwave technology (MR)/infrared/radio)



Using the integrated **CCT** switch, the light colour can be switched between 3000K and 4000K during installation.



Indicates **lights with RGB+W** and **RGB**  
(Red-Green-Blue + White and Red-Green-Blue)



- **USB charging function**
- **Inductive (wireless) charging function** for Smartphones



Indicates products that **can be combined**



Indicates lights that, after priming **can be individually covered with wall paint or wallpaper**.



Indicates lights from a single **lighting family**



**Award-winning lights**  
· Red Dot Design Award  
· German Design Award

# CUSTOMER INFORMATION

---

## Information regarding light housing heat generation

Halogen lightbulbs operate at high temperatures and can lead to the heating of the light housing. They should therefore only be touched once the housing has cooled down. Adjustable lights and light heads that do not feature insulated positioning levers, or which exceed the maximum permissible housing temperature at the positioning point when operated at maximum wattage, should also be mounted out of reach. LED retrofit lightbulbs offer a low-temperature alternative to most of our halogen lights.

## Luminous flux

The total amount of light produced by a light source is given in lumens (lm).

## Luminosity

The luminosity is the luminous flux indicated per solid angle and is expressed in candelas (cd).

## Colour rendering index

The colour rendering property of a light source is indicated by the Colour Rendering Index (CRI). A CRI of 80 or higher is required for light sources used indoors. Light sources used outdoors must have a CRI of at least 65.

## Light colour

The light colour of a light source is indicated in K (Kelvin).

## Standard LED

This is the classic version of the LED (3 mm or 5 mm LED). These were originally developed for indication purposes, e.g. in instrument panels.

## Standard SMD LED

SMD means "Surface Mounted Device". This is a compact LED that is soldered directly onto the circuit board without wire connections. SMDs are available in different sizes and are suitable for lighting purposes.

## PowerLED

PowerLED is a high-performance LED with a performance of 1W or more. It places increased demands on current constancy and should therefore always be operated with constant current sources. If you wish to connect several LEDs, they must therefore be connected in series. A parallel connection is not permitted. Please ensure that you observe the installation sequence so that the LEDs are not exposed to high current for a short time, which could damage them. Ultimately, the following rule applies: first you should completely connect the secondary circuit (LEDs to driver), then you should close the primary circuit (driver to power source).

## Chip On Board LED (COB LED); Area LED

This is an LED with an exceptionally flat shape. The advantage of COB LEDs is good heat dissipation when technically implemented with cooling surfaces, which enables high light output and a long lifespan.

## Stainless Steel 304

(1.4301) Good resistance to corrosion is shown in natural environmental media (water, urban and rural atmosphere) in the absence of significant chlorine and salt concentrations. 1.4301 is, however, not suitable for use in areas where there is contact with seawater, salt water or a salty atmosphere, or for use in swimming pools or similar contexts.

## Stainless Steel 316

(1.4404) In natural environmental media (water, urban and rural atmosphere) as well as in industrial areas with moderate chlorine and salt concentration, in the food and pharmaceutical industry and in the agricultural food sector, 1.4404 shows excellent resistance to corrosion. 1.4404 is not resistant to seawater.

## Please note:

A large part of the products shown in this catalogue are protected by trademarks, registered designs, utility models or patents. Any violation of these property rights or the use of text and layout design or copyrighted images without our authorisation will be prosecuted. The illustrations and information contained in this catalogue are for illustrative purposes only and are not legally binding in terms of colour, shape, design or technical details. All product descriptions and specifications are subject to alteration and errors.

All of the products in our range are subject to our strict quality assurance procedures and comply with generally applicable standards. This catalogue contains a general range and is not country specific. Any deviations from country-specific guidelines must be clarified before ordering. SLV cannot be held responsible for any deviations in terms of technical standards.

All weights and dimensions are given in kg and cm respectively unless stated otherwise. We reserve the right to make technical alterations!

The presentation of our lights with realistic photos showing examples of use is possible thanks to the kind cooperation and agreement of the owners or designers of the environments depicted in the images. We would like to take this opportunity to thank all those who contributed to the creation and use of our photos by giving their consent!

With the appearance of this catalogue, the prices stated in previous lists and catalogues are rendered invalid.

---

## Publisher

SLV GmbH, Germany  
Daimlerstrasse 21-23  
52531 Uebach-Palenberg  
T +49 2451 4833-355  
slv.com

## Copyright

© SLV GmbH, 2020

## Image credits

SLV GmbH  
External photographers: Andreas Fein, Anja Lynen, Gerd Arnolds,  
Günther Preissler, Marc Derkum, Dirk Hoffmann



EXPERIENCE LIGHT



Innovative use of combined heat and power technology when printing this product reduced CO<sub>2</sub> emissions by up to 52% in comparison to conventional methods in Germany.